

NOTES:

ELECTRICAL:

- 1.Contact Resistance : 20MΩ MAX
2. Insulation Resistance : 500MΩ MIN @ 500V DC
3. Withstand Voltage : DC 1000V AC 700V RMS 60Hz, 1MIN
4. Compliance with Class I up to 2000 MHz to ISO/IEC 11801-1:2017 (Ed. 1. 0)

ENVIRONMENTAL:

1. Storage Temperature : -40°C ~ +70°C
2. Operation Temperature : -10°C ~ +60°C

MECHANICAL

1. MATERIAL: Zinc alloy
2. IDC MATERIAL: PC TERMINAL: PHOSPHOR BRONZE, TIN PLATING
3. RJ45 Contact Life: 750 Times Min
4. Plug inforce: <30N
5. Solid cable: 1/22AWG (0.65MM) - 1/26AWG (0.4MM) ID: 1.1MM - 1.6MM
6. Stranded cable: 22/7-26/7AWG ID: 1.1MM - 1.6MM
7. Cable OD: 5.0mm - 8.5mm
8. PoE per IEEE 802.3af, PoE+ per IEEE 802.3at, PoE++ per IEEE 802.3bt
RoHS 2.0 and REACH Compliant
9. with copper foil in packing.

MATERIAL LIST:

⑦	Housing	Zinc alloy Silver	1	
⑥	RJ 45 JACK INSERT	PHOSPHOR BRONZE 8P8C GOLD PLATED	8	
⑤	PCB	FR-4 1.6mm	1	
④	IDC BODY	White PC	1	
③	IDC PIN	PHOSPHOR BRONZE & TINNED	8	
②	LABEL COLOR CODE	T568A/B	2	
①	IDC TERMINAL	FOR 22-26AWG CABLE	1	

NO	PARTS NAME	SPECIFICATION STANDARD	QT' Y	REMARK
		NEW	2020-09-01	A
BY	CHK	REVISION RECORD MODIFICATIONS	DATE	REV.

SYNERGY 21					
CUSTOMER	ALLNET Computersysteme GmbH	ITEM NO.	S216378		
PRODUCT NAME	CAT 8.1 STP KEYSTONE JACK	manufacture country:	china	UNIT	MM
DRAWNBY	CHECKBY	APPOBY	DATE		
SYNERGY 21	SYNERGY 21	SYNERGY 21	2020-09-01		

Installationsanleitung/Installation guide

Keystone Jack

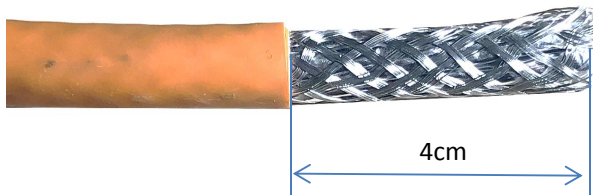

①.Stripping 4cm of sheath.

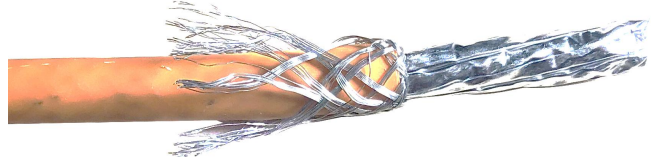

②.foldback braided and drained wire.

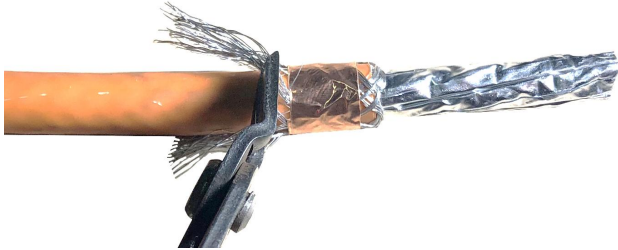

③.paste copper foil on the braided and ground wire and cut off the excess weave and the ground wire

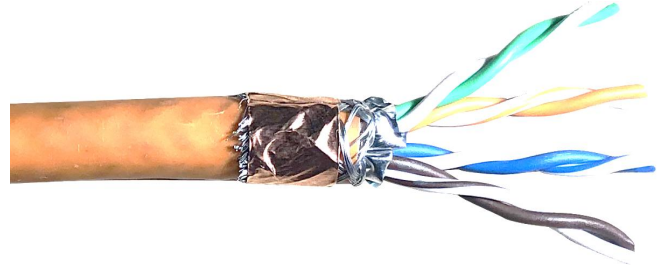

④.4.Fan out all four twisted pairs, allocate each by following colorcoding label

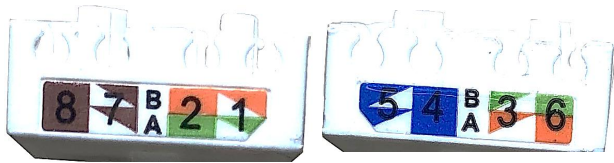

⑤.Across the holde by the color marks of T568A or T568B

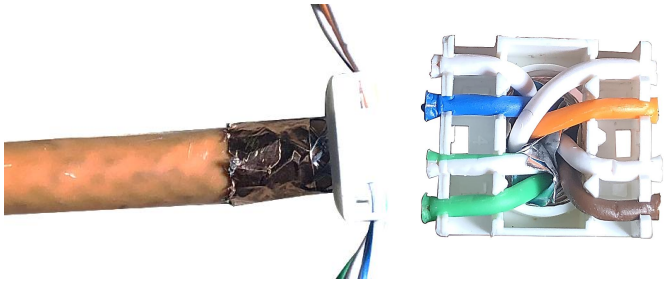

⑥. allocate each conductor into proper slots on wiring cap by following color coding



⑦.Trim the theends of conductors.

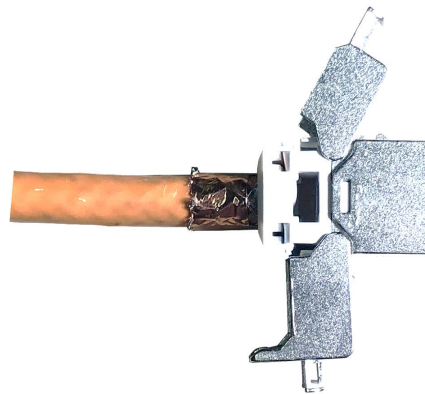

⑧.install the termination cap in direction of arrow into the keystone jack

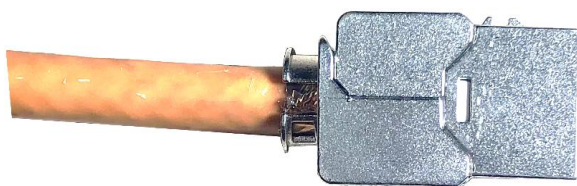

⑨.press both covers of the keystone jack to contact the cable

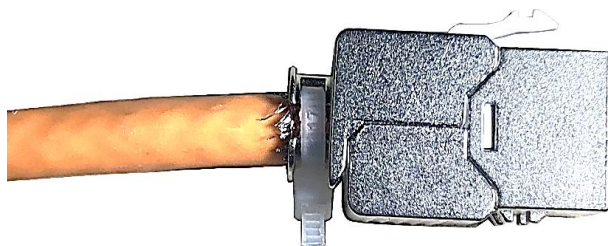

⑩.use cable tie for strain relief and to fix the shielding clamp

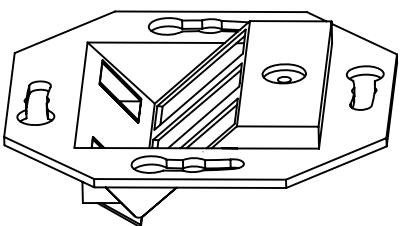
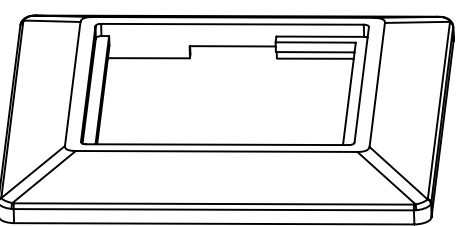
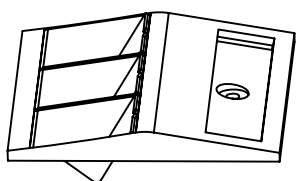

ITEM NO	COLOUR
S216327	pure white, RAL9010
S216326	pearl white, RAL1013

Chart:

Materials:

Outlet Housing: Fireproof ABS UL-94V0/Colour:see the chart
 Outlet Base:Fireproof ABS UL-94V0/Colour:see the chart
 Metallic Plate:Al&Zn Alloy /Al&Zn Alloy,
 ACCESSORY :
 1. Label
 2. Plastic gasket
 3. Screw:M4*9*2Pcs
 Apply to the keystone jack which the width less than 17.2mm
 RoHS Compliant
 Packing: 1pcs/PE bag+lable, 12pcs/box+lable, 120pcs/carton

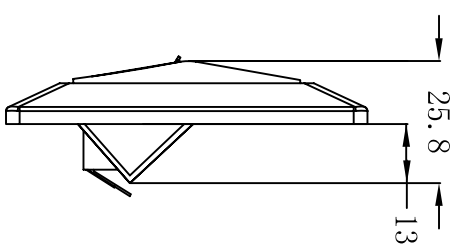
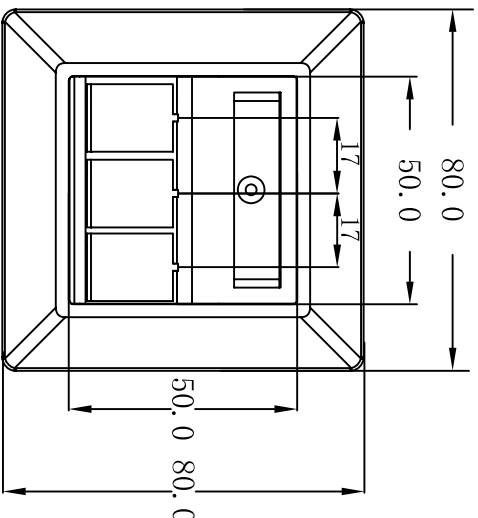

SYNERGY 21

CUSTOMER		ITEM NO.		see the chart	
PRODUCT NAME	FRAME SET 3PORT	manufacture country	China	UNIT	MM
NEW					
2011-07-11	A				
DATE	REV.	SYNERGY 21	SYNERGY 21	SYNERGY 21	2011-07-11

REVISION RECORD MODIFICATIONS

BY CHK