

ASCY-Cx0x-xxxx2

Low-Power 2216 DFN2 Surface-Mount LED

Description

The Broadcom[®] ASCY-Cx0x surface-mount LEDs use InGaN and AlInGaP chips in a small form-factor DFN-2 package. The LEDs are designed with high-reliability performance to work under a wide range of environmental conditions. The small form-factor package also enables flexibilities in product designs, which is ideal for a wide range of applications.

To facilitate easy pick-and-place assembly, the LEDs are packed in tape and reel. Every reel is shipped in single intensity and color bin to provide close uniformity.

Features

- High-reliability package with enhanced silicone resin encapsulation.
- Small package form-factor and thickness for better design flexibility.
- Available in Blue, Green, Yellow Green, Amber, Orange and Red.
- JEDEC MSL 3.

Applications

- Status indicators
- Electronic signs and displays
 - Channel lettering
 - Contour lighting
 - Indoor variable message signs
- Office automations, home appliances, and industrial equipment
 - Front panel backlighting
 - Push button backlighting
 - Display backlighting
 - Keypad backlighting
 - Symbol backlighting
 - Scanner lighting

CAUTION! This LED is ESD sensitive. Observe appropriate precautions during handling and processing. Refer to application note AN-1142 for additional details.

Figure 1: Package Drawing
White Surface

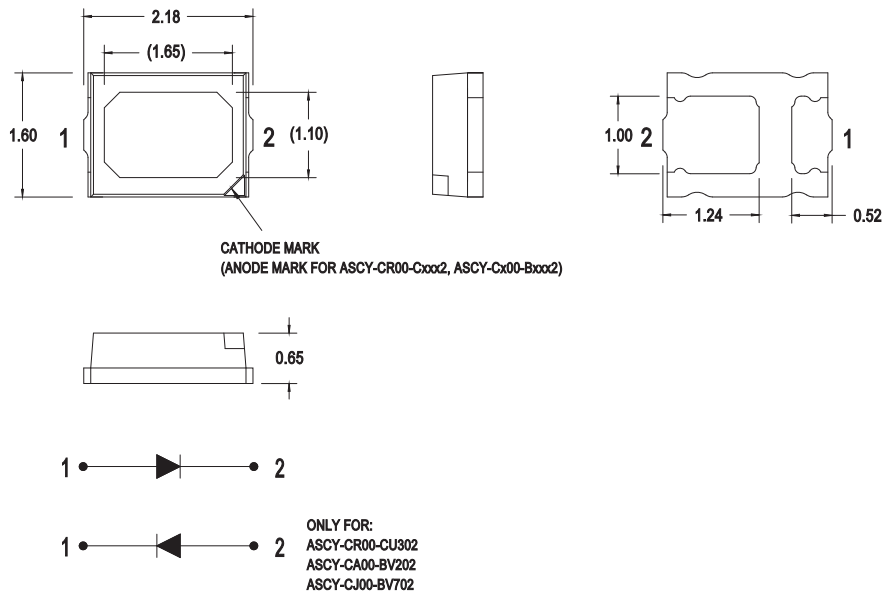

Black Surface

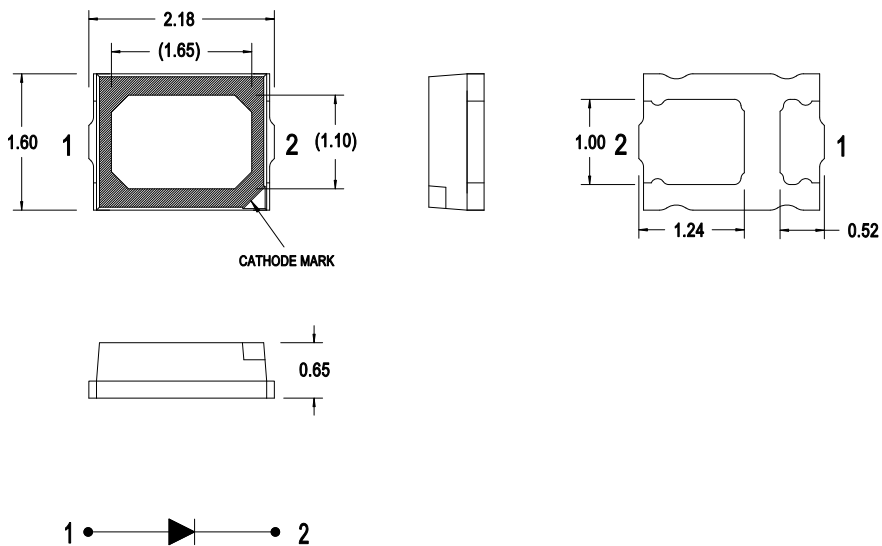

NOTE:

1. All dimensions in millimeters (mm).
2. Tolerance is ± 0.20 mm unless otherwise specified.
3. Encapsulation = silicone.
4. Terminal finish = silver plating.
5. Dimensions in brackets are for reference only.

Device Selection Guide ($T_J = 25^\circ\text{C}$, $I_F = 20\text{ mA}$)

Part Number	Color	Die Type	Surface	Luminous Intensity, I_V (mcd) ^{a, b}			Luminous Flux, Φ_V (lm) ^c
				Min.	Typ.	Max.	Typ.
ASCY-CB00-NT302	Blue	InGaN	White	285	420	560	1.5
ASCY-CG00-NW602	Green	InGaN	White	1400	1630	2240	5.8
ASCY-CG00-PX202	Green (HB) ^d	InGaN	White	1800	2080	2850	7.2
ASCY-CF00-AQ702	Yellow Green	AllnGaP	White	90	140	180	0.5
ASCY-CA00-AS7C2	Amber	AllnGaP	White	224	320	450	1.0
ASCY-CA02-AS7C2	Amber	AllnGaP	Black	224	320	450	1.0
ASCY-CA00-BV202	Amber (HB) ^d	AllnGaP	White	715	850	1125	2.6
ASCY-CJ00-AS302	Orange	AllnGaP	White	180	250	355	0.8
ASCY-CJ00-BV702	Orange (HB) ^d	AllnGaP	White	900	1100	1800	3.3
ASCY-CR00-AS702	Red	AllnGaP	White	224	330	450	1.0
ASCY-CR00-CU302	Red (HB) ^d	AllnGaP	White	450	590	900	1.9

- a. The luminous intensity, I_V , is measured at the mechanical axis of the package and it is tested with a single current pulse condition. The actual peak of the spatial radiation pattern may not be aligned with the axis.
- b. Tolerance is $\pm 12\%$.
- c. For reference only.
- d. (HB) – High Brightness series.

Absolute Maximum Ratings

Parameters	InGaN	AllnGaP	AllnGaP Amber (HB)	Units
DC Forward Current ^a	30			mA
Peak Forward Current ^b	100			mA
Power Dissipation	108	72	75	mW
Reverse Voltage	Not designed for reverse bias operation			
LED Junction Temperature	110	125		$^\circ\text{C}$
Operating Temperature Range	-40 to +100			$^\circ\text{C}$
Storage Temperature Range	-40 to +100			$^\circ\text{C}$

- a. Derate linearly as shown in [Figure 18](#), [Figure 19](#), [Figure 20](#), and [Figure 21](#).
- b. Duty factor = 10%, frequency = 1 kHz, $T_A = 25^\circ\text{C}$.

Optical and Electrical Characteristics (T_J = 25°C, I_F = 20 mA)

Parameters	Min.	Typ.	Max.	Units
Viewing Angle, 2θ _{1/2} ^a				°
Blue	—	125	—	
Green, Green (HB)	—	125	—	
Yellow Green	—	120	—	
Amber, Amber (HB)	—	120	—	
Orange, Orange (HB)	—	120	—	
Red	—	120	—	
Red (HB)	—	120	—	
Forward Voltage, V _F ^b				V
Blue	2.6	3.0	3.6	
Green	2.6	3.1	3.6	
Green (HB)	2.6	3.0	3.6	
Yellow Green	1.8	2.1	2.4	
Amber	1.8	2.0	2.4	
Amber (HB)	1.8	2.3	2.5	
Orange	1.8	2.1	2.4	
Orange (HB)	1.8	2.2	2.4	
Red	1.8	2.0	2.4	
Red (HB)	1.8	2.2	2.4	
Reverse Current, I _R at V _R = 5V ^c	—	—	10	μA
Dominant Wavelength, λ _d ^d				nm
Blue	460.0	469	480.0	
Green	515.0	522	535.0	
Green (HB)	515.0	523	535.0	
Yellow Green	564.5	571	576.5	
Amber, Amber (HB)	583.0	589	595.0	
Orange, Orange (HB)	597.0	602	612.0	
Red, Red (HB)	618.0	621	635.0	
Peak Wavelength, λ _p				nm
Blue	—	465	—	
Green	—	516	—	
Green (HB)	—	517	—	
Yellow Green	—	572	—	
Amber, Amber (HB)	—	592	—	
Orange, Orange (HB)	—	607	—	
Red	—	629	—	
Red (HB)	—	630	—	

Parameters	Min.	Typ.	Max.	Units
Thermal Resistance, $R_{\theta J-S}^e$				$^{\circ}C/W$
Blue	—	100	—	
Green	—	115	—	
Green (HB)	—	115	—	
Yellow Green	—	160	—	
Amber	—	180	—	
Amber (HB)	—	100	—	
Orange	—	220	—	
Orange (HB)	—	100	—	
Red	—	240	—	
Red (HB)	—	130	—	

- a. $\theta_{1/2}$ is the off-axis angle where the luminous intensity is half of the peak intensity.
- b. Forward voltage tolerance is $\pm 0.1V$.
- c. Indicates product final test condition. Long term reverse bias is not recommended.
- d. The dominant wavelength is derived from the CIE Chromaticity diagram and represents the perceived color of the device.
- e. Thermal resistance from the LED junction to the solder point.

Part Numbering System

A S C Y - C x₁ 0 x₂ - x₃ x₄ x₅ x₆ 2

Code	Description	Option	
x ₁	Color	B	Blue
		G	Green
		F	Yellow Green
		A	Amber
		J	Orange
		R	Red
x ₂	Surface Color	0	White
		2	Black
x ₃	Die Type	A	AllInGaP
		B	AllInGaP Amber (HB), Orange (HB)
		C	AllInGaP Red (HB)
		N	InGaN
		P	InGaN (HB)
x ₄	Minimum Intensity Bin	See Intensity Bin Limits (CAT)	
x ₅	Number Of Intensity Sub-Bins	2	2 sub-bins, starting from bin x ₄ 1
		3	3 sub-bins, starting from bin x ₄ 1
		6	2 sub-bins, starting from bin x ₄ 2
		7	3 sub-bins, starting from bin x ₄ 2
x ₆	Color Bins	0	Full distribution
		C	3 and 4 only

Part Number Example

ASCY-CA00-AS7C2

- x₁: A — Amber
- x₂: 0 — White surface color
- x₃: A — AllnGaP
- x₄: S — Minimum intensity bin S
- x₅: 7 — 3 sub-bins, starting from bin S2
- x₆: C — Color bins 3 and 4 only

Bin Information

Intensity Bin Limits (CAT)

Bin ID	Luminous Intensity, I _v (mcd)	
	Min.	Max.
Q2	90.0	112.5
R1	112.5	140.0
R2	140.0	180.0
S1	180.0	224.0
S2	224.0	285.0
T1	285.0	355.0
T2	355.0	450.0
U1	450.0	560.0
U2	560.0	715.0
V1	715.0	900.0
V2	900.0	1125.0
W1	1125.0	1400.0
W2	1400.0	1800.0
X1	1800.0	2240.0
X2	2240.0	2850.0

Tolerance = ± 12%.

Forward Voltage Bin Limits (V_F)

Bin ID	Forward Voltage, V _F (V)	
	Min.	Max.
H11	1.8	1.9
H12	1.9	2.0
H13	2.0	2.1
H14	2.1	2.2
H15	2.2	2.3
H16	2.3	2.4
H17	2.4	2.5
G01	2.6	2.7
G02	2.7	2.8
G03	2.8	2.9
G04	2.9	3.0
G05	3.0	3.1
G06	3.1	3.2
G07	3.2	3.3
G08	3.3	3.4
G09	3.4	3.5
G10	3.5	3.6

Tolerance = ± 0.1V.

Color Bin Limits (BIN)

Blue

Bin ID	Dominant Wavelength, λ_d (nm)	
	Min.	Max.
1	460	465
2	465	470
3	470	475
4	475	480

Green

Bin ID	Dominant Wavelength, λ_d (nm)	
	Min.	Max.
1	515	520
2	520	525
3	525	530
4	530	535

Yellow Green

Bin ID	Dominant Wavelength, λ_d (nm)	
	Min.	Max.
1	564.5	567.5
2	567.5	570.5
3	570.5	573.5
4	573.5	576.5

Amber

Bin ID	Dominant Wavelength, λ_d (nm)	
	Min.	Max.
2	583.0	586.0
3	586.0	589.0
4	589.0	592.0
5	592.0	595.0

Orange

Bin ID	Dominant Wavelength, λ_d (nm)	
	Min.	Max.
1	597.0	600.0
2	600.0	603.0
3	603.0	606.0
4	606.0	609.0
5	609.0	612.0

Red

Bin ID	Dominant Wavelength, λ_d (nm)	
	Min.	Max.
0	618.0	635.0

Tolerance = ± 1 nm.

Example of bin information on reel and packaging label:

CAT: S2 — Intensity bin S2
 BIN: 3 — Color bin 3
 VF: G05 — VF bin G05

Figure 2: Spectral Power Distribution (InGaN)

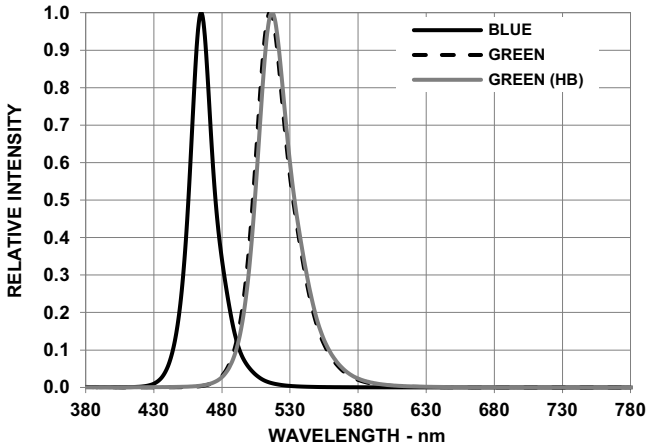

Figure 3: Spectral Power Distribution (AlInGaP)

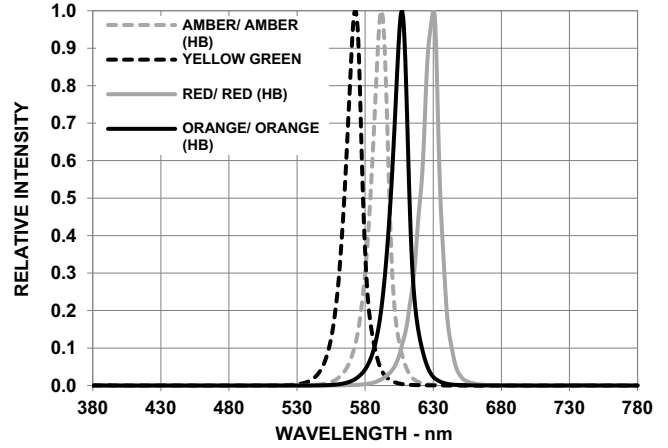

Figure 4: Forward Current vs. Forward Voltage (InGaN)

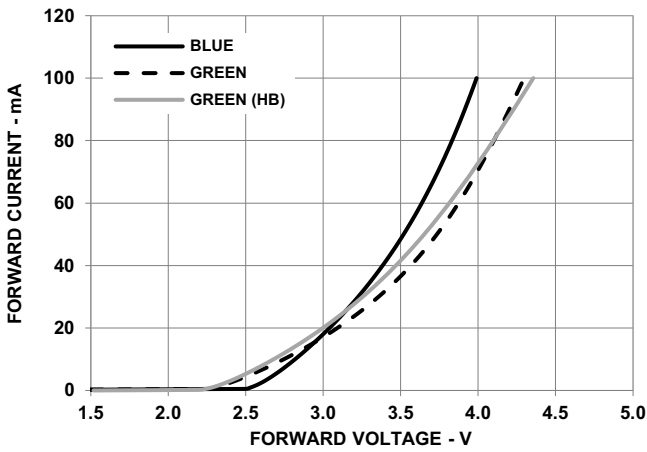

Figure 5: Forward Current vs. Forward Voltage (AlInGaP Amber, Yellow Green, Red/Red (HB), and Orange)

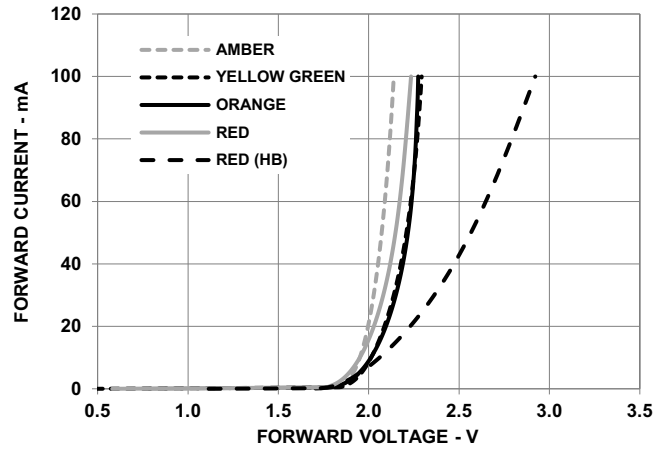

Figure 6: Forward Current vs. Forward Voltage (AlInGaP Amber (HB) and Orange (HB))

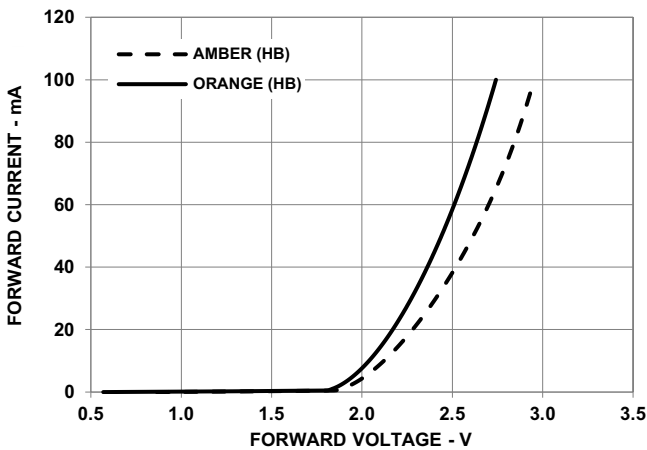

Figure 7: Relative Luminous Intensity vs. Mono Pulse Current

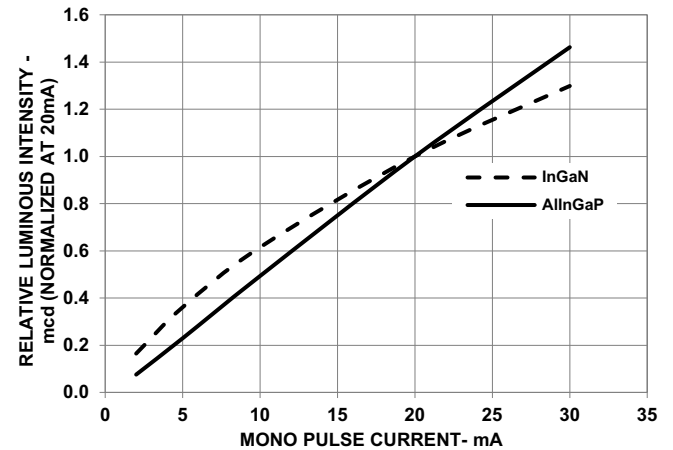

Figure 8: Radiation Pattern

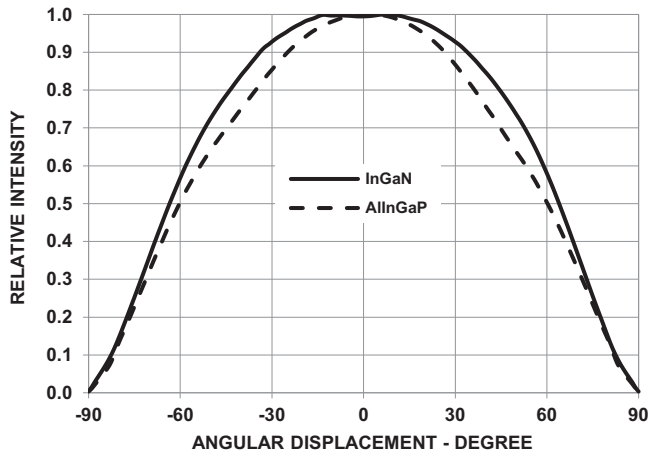

Figure 9: Dominant Wavelength Shift vs. Mono Pulse Current

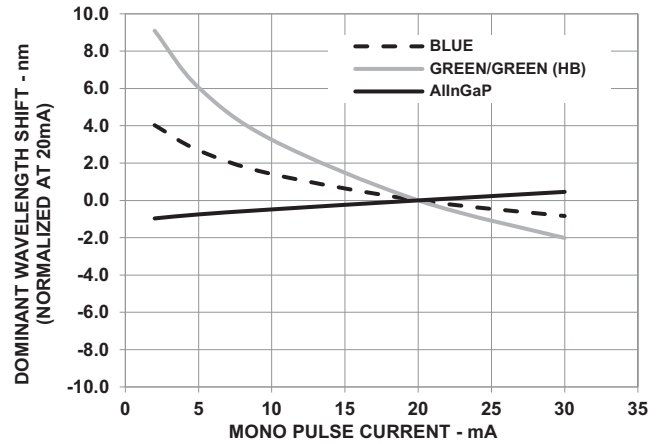

Figure 10: Forward Voltage Shift vs. Junction Temperature (InGaN)

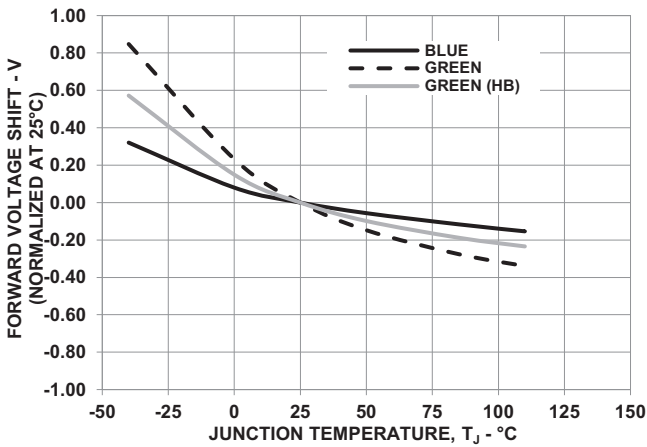

Figure 11: Forward Voltage Shift vs. Junction Temperature (AlInGaP Amber, Yellow Green, Red/Red (HB), and Orange)

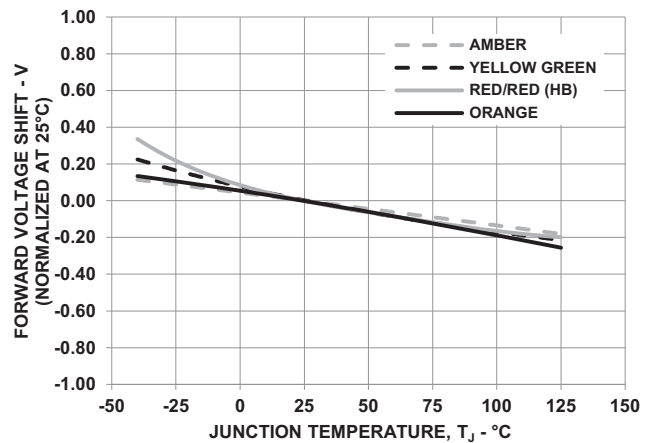

Figure 12: Forward Voltage Shift vs. Junction Temperature (AlInGaP Amber (HB) and Orange (HB))

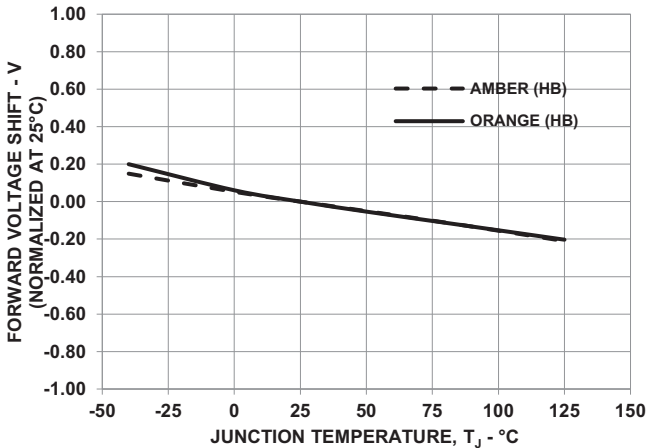

Figure 13: Relative Luminous Intensity vs. Junction Temperature (InGaN)

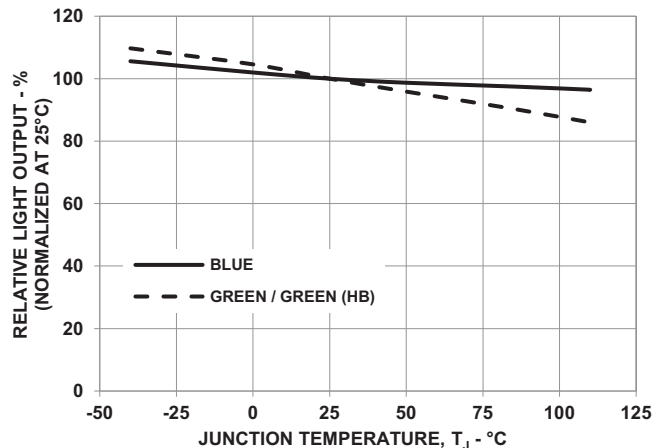

Figure 14: Relative Luminous Intensity vs. Junction Temperature (AlInGaP Amber, Yellow Green, Red/Red (HB), and Orange)

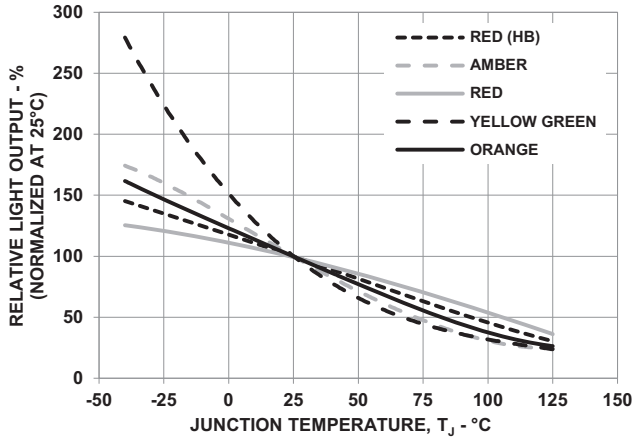

Figure 15: Relative Luminous Intensity vs. Junction Temperature (AlInGaP Amber (HB) and Orange (HB))

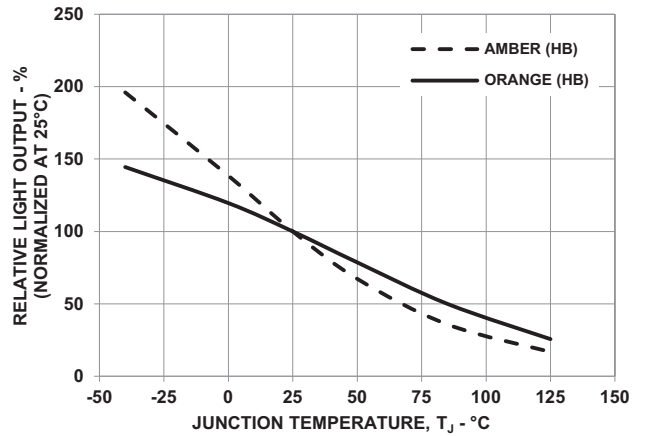

Figure 16: Dominant Wavelength Shift vs. Junction Temperature (InGaN)

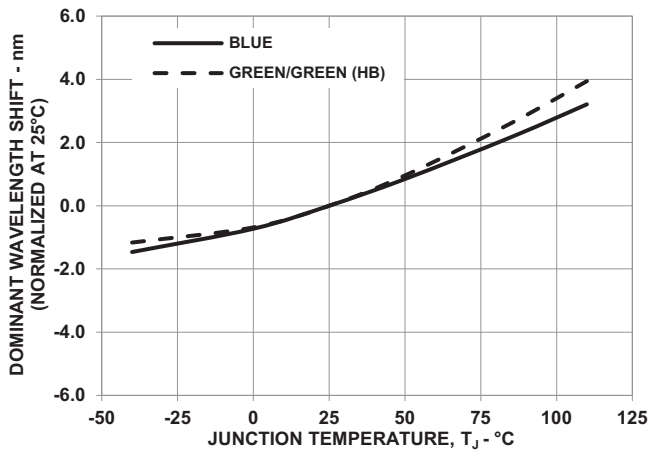

Figure 17: Dominant Wavelength Shift vs. Junction Temperature (AlInGaP)

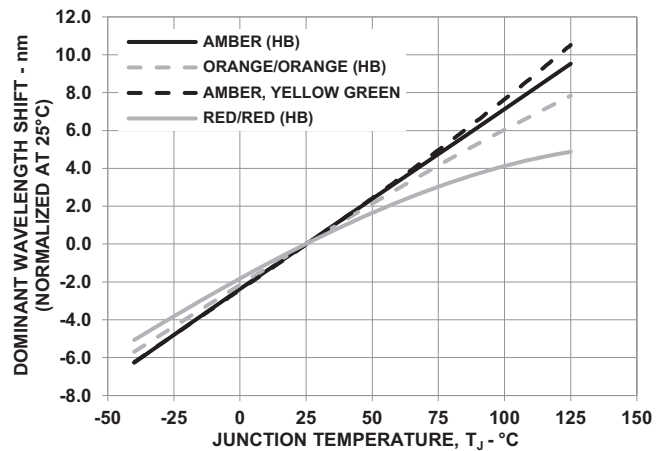

Figure 18: Maximum Forward Current vs. Ambient Temperature. Derated based on $T_{JMAX} = 110^{\circ}C$ (InGaN Only)

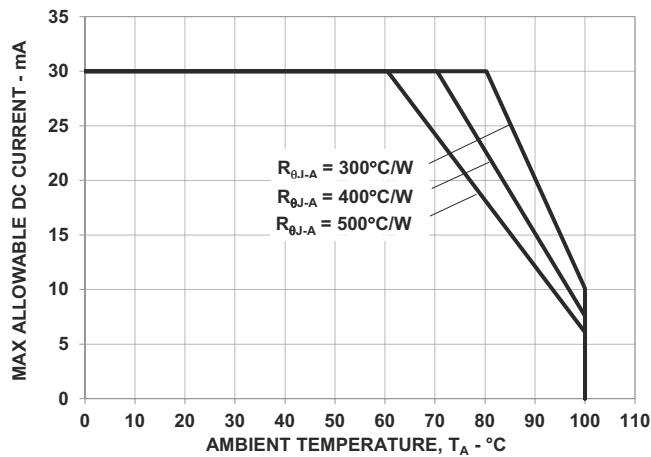

Figure 19: Maximum Forward Current vs. Ambient Temperature. Derated based on $T_{JMAX} = 110^{\circ}C$ (AlInGaP Only)

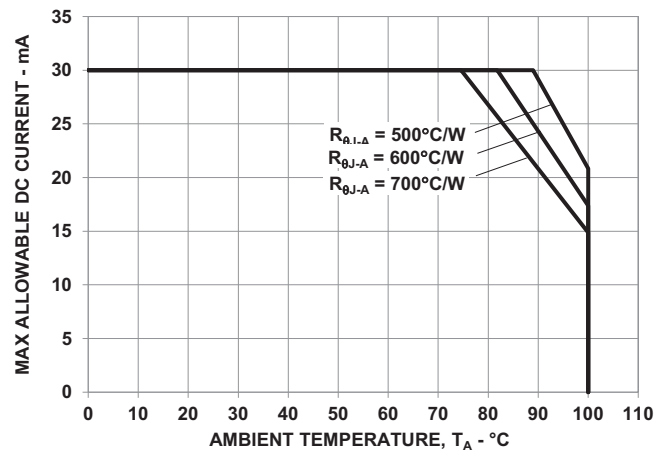

Figure 20: Maximum Forward Current vs. Solder Point Temperature. Derated based on $T_{JMAX} = 110^{\circ}C$ (InGaN Only)

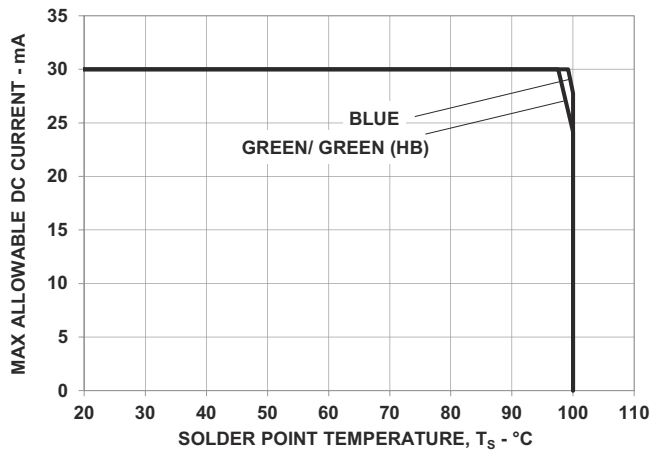

Figure 21: Maximum Forward Current vs. Solder Point Temperature. Derated based on $T_{JMAX} = 110^{\circ}C$ (AllInGaP Only)

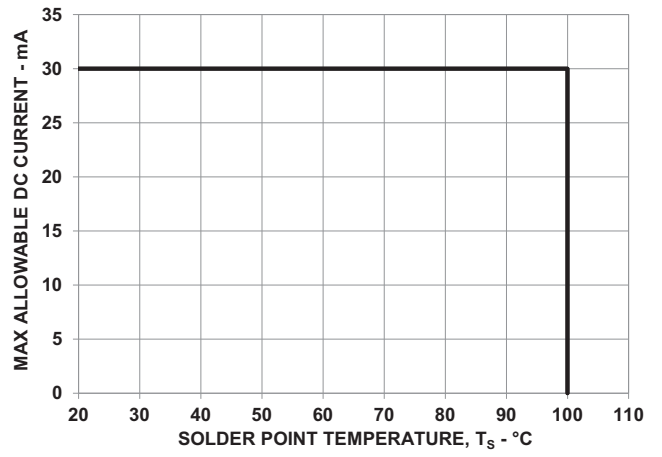
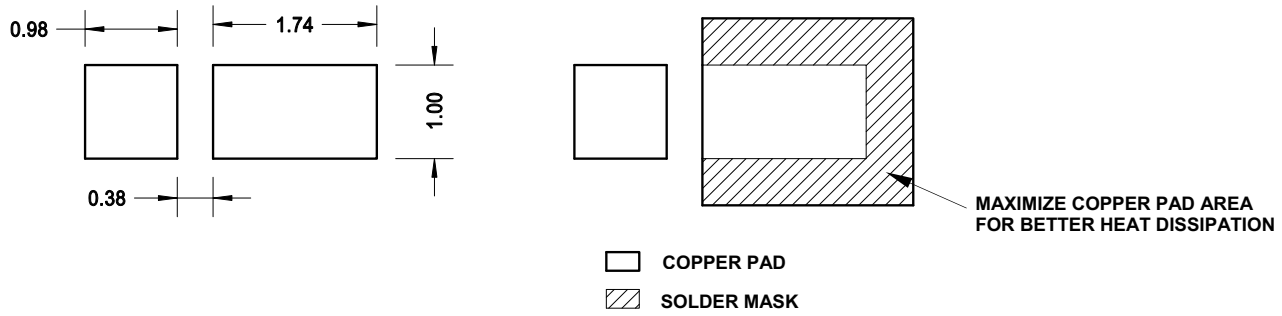
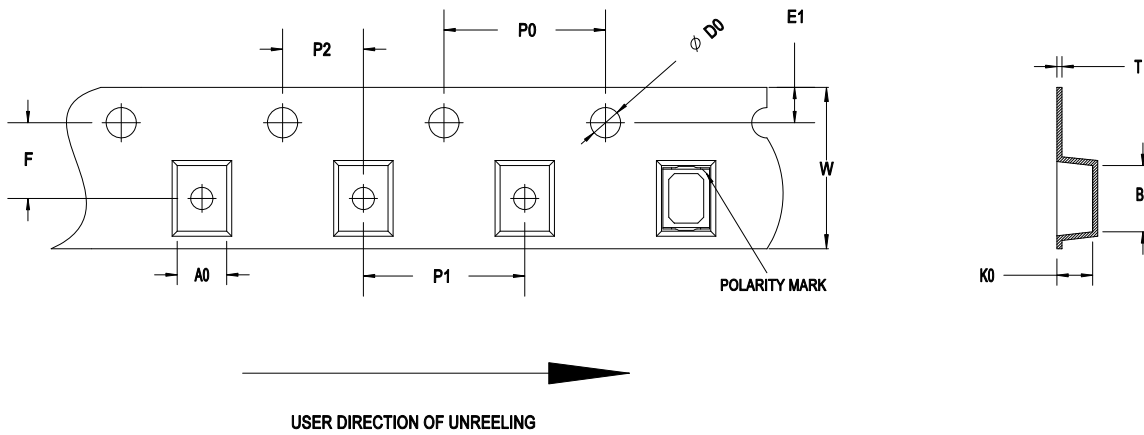

Figure 22: Recommended Soldering Land Pattern



NOTE: All dimensions are in millimeters (mm).

Figure 23: Carrier Tape Dimensions



F	P0	P1	P2	D0	E1	W
3.5 ± 0.05	4.0 ± 0.1	4.0 ± 0.1	2.0 ± 0.05	1.55 ± 0.05	1.75 ± 0.1	8.0 ± 0.3

T	B0	K0	A0
0.2 ± 0.05	2.25 ± 0.1	0.7 ± 0.1	1.75 ± 0.1

NOTE: All dimensions are in millimeters (mm).

Figure 24: Reel Dimensions

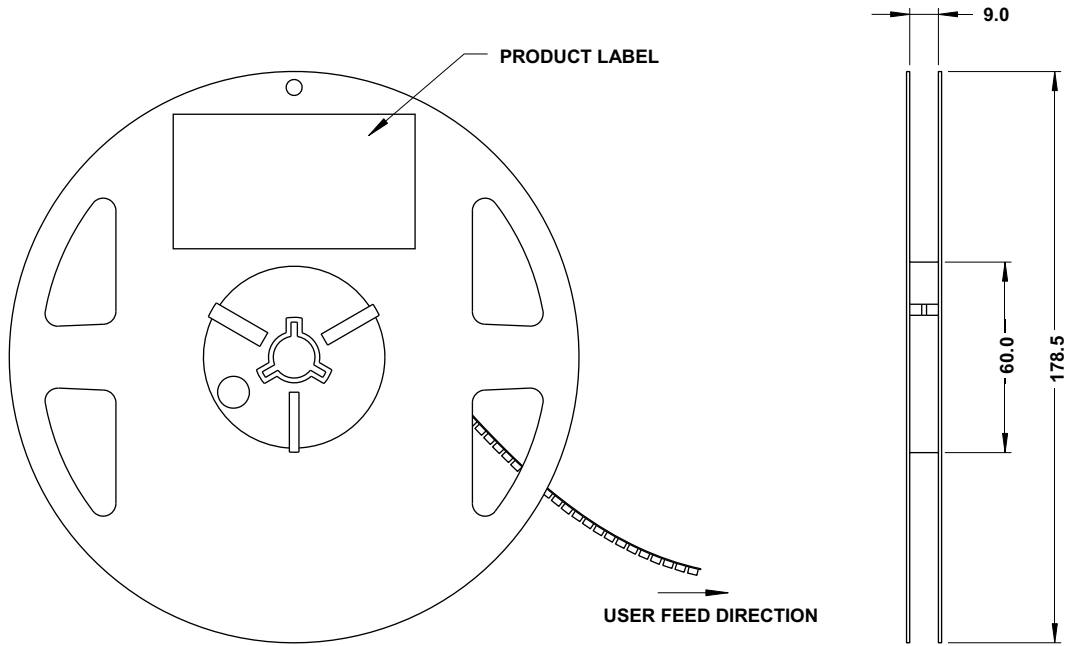

NOTE: All dimensions are in millimeters (mm).

Precautionary Notes

Soldering

- Do not perform reflow soldering more than twice. Observe necessary precautions of handling moisture-sensitive device as stated in the following section.
- Do not apply any pressure or force on the LED during reflow and after reflow when the LED is still hot.
- Use reflow soldering to solder the LED. Use hand soldering only for rework if unavoidable, but it must be strictly controlled to following conditions:
 - Soldering iron tip temperature = 315°C maximum
 - Soldering duration = 3 seconds maximum
 - Number of cycles = 1 only
 - Power of soldering iron = 50W maximum
- Do not touch the LED package body with the soldering iron except for the soldering terminals, because it may cause damage to the LED.
- Confirm beforehand whether the functionality and performance of the LED is affected by soldering with hand soldering.

Figure 25: Recommended Lead-Free Reflow Soldering Profile

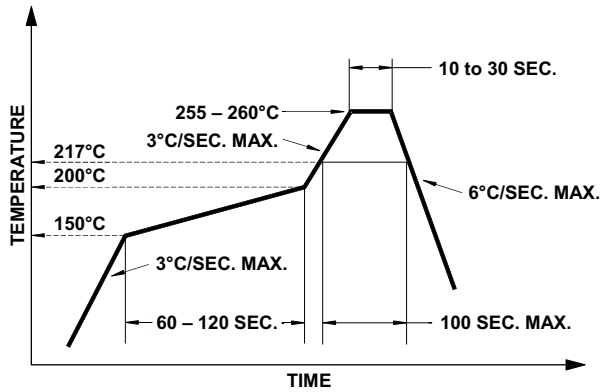
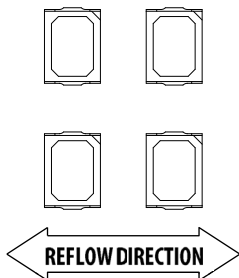

Figure 26: Recommended Board Reflow Direction



Handling Precautions

The encapsulation material of the LED is made of silicone for better product reliability. Compared to epoxy encapsulant, which is hard and brittle, silicone is softer and flexible. Observe special handling precautions during assembly of silicone encapsulated LED products. Failure to comply might lead to damage and premature failure of the LED. Refer to Broadcom Application Note AN5288, *Silicone Encapsulation for LED: Advantages and Handling Precautions*, for additional information.

- Do not poke sharp objects into the silicone encapsulant. Sharp objects, such as tweezers or syringes, might apply excessive force or even pierce through the silicone and induce failures to the LED die or wire bond.
- Do not touch the silicone encapsulant. Uncontrolled force acting on the silicone encapsulant might result in excessive stress on the wire bond. Hold the LED only by the body.
- Do not stack assembled PCBs together. Use an appropriate rack to hold the PCBs.
- The surface of the silicone material attracts dust and dirt easier than epoxy due to its surface tackiness. To remove foreign particles on the surface of silicone, use a cotton bud with isopropyl alcohol (IPA). During cleaning, rub the surface gently without putting too much pressure on the silicone. Ultrasonic cleaning is not recommended.
- For automated pick and place, Broadcom has tested a nozzle size with OD 1.5 mm to work with this LED. However, due to the possibility of variations in other parameters such as pick and place machine maker/model, and other settings of the machine, verify that the selected nozzle will not cause damage to the LED.

Handling of Moisture-Sensitive Devices

This product has a Moisture Sensitive Level 3 rating per JEDEC J-STD-020. Refer to Broadcom Application Note AN5305, *Handling of Moisture Sensitive Surface Mount Devices*, for additional details and a review of proper handling procedures.

Before use:

- An unopened moisture barrier bag (MBB) can be stored at $40^{\circ}\text{C}/90\% \text{ RH}$ for 12 months. If the actual shelf life has exceeded 12 months and the humidity indicator card (HIC) indicates that baking is not required, it is safe to reflow the LEDs per the original MSL rating.
- Do not open the MBB prior to assembly (for example, for IQC). If unavoidable, MBB must be properly resealed with fresh desiccant and HIC. The exposed duration must be taken in as floor life.

Control after opening the MBB:

- Read the HIC immediately upon opening of the MBB.
- Keep the LEDs at $30^{\circ}\text{C}/60\% \text{ RH}$ at all times, and complete all high temperature-related processes, including soldering, curing, or rework, within 168 hours.

Control for unfinished reel:

Store unused LEDs in a sealed MBB with desiccant or a desiccator at $5\% \text{ RH}$.

Control of assembled boards:

If the PCB soldered with the LEDs is to be subjected to other high-temperature processes, store the PCB in a sealed MBB with desiccant or desiccator at $5\% \text{ RH}$ to ensure that all LEDs have not exceeded their floor life of 168 hours.

Baking is required if the following conditions exist:

- The HIC indicator indicates a change in color for 10% and 5%, as stated on the HIC.
- The LEDs are exposed to conditions of $30^{\circ}\text{C}/60\% \text{ RH}$ at any time.
- The LED's floor life exceeded 168 hours.

The recommended baking condition is: $60^{\circ}\text{C} \pm 5^{\circ}\text{C}$ for 20 hours.

Baking can only be done once.

Storage:

The soldering terminals of these Broadcom LEDs are silver plated. If the LEDs are exposed in an ambient environment for too long, the silver plating might become oxidized, thus affecting its solderability performance. As such, keep unused LEDs in a sealed MBB with desiccant or in a desiccator at $5\% \text{ RH}$.

Application Precautions

- The drive current of the LED must not exceed the maximum allowable limit across temperature as stated in the data sheet. Constant current driving is recommended to ensure consistent performance.
- Circuit design must cater to the whole range of forward voltage (V_F) of the LEDs to ensure the intended drive current can always be achieved.
- The LED exhibits slightly different characteristics at different drive currents, which may result in a larger variation of performance (meaning: intensity, wavelength, and forward voltage). Set the application current as close as possible to the test current to minimize these variations.
- The LED is not intended for reverse bias. Use other appropriate components for such purposes.
- Do not use the LED in the vicinity of material with sulfur content or in environments of high gaseous sulfur compounds and corrosive elements. Examples of material that might contain sulfur are rubber gaskets, room-temperature vulcanizing (RTV) silicone rubber, rubber gloves, and so on. Prolonged exposure to such environments may affect the optical characteristics and product life.
- White LEDs must not be exposed to acidic environments and must not be used in the vicinity of any compound that may have acidic outgas, such as, but not limited to, acrylate adhesive. These environments have an adverse effect on LED performance.
- Avoid rapid change in ambient temperature, especially in high-humidity environments, because they cause condensation on the LED.
- If the LED is intended to be used in harsh or outdoor environment, protect the LED against damages caused by rain, water, dust, oil, corrosive gases, external mechanical stresses, and so on.

Thermal Management

The optical, electrical, and reliability characteristics of the LED are affected by temperature. Keep the junction temperature (T_J) of the LED below the allowable limit at all times. T_J can be calculated as follows:

$$T_J = T_A + R_{\theta J-A} \times I_F \times V_{Fmax}$$

where:

T_A = Ambient temperature ($^{\circ}C$)

$R_{\theta J-A}$ = Thermal resistance from LED junction to ambient ($^{\circ}C/W$)

I_F = Forward current (A)

V_{Fmax} = Maximum forward voltage (V)

The complication of using this formula lies in T_A and $R_{\theta J-A}$. Actual T_A is sometimes subjective and hard to determine. $R_{\theta J-A}$ varies from system to system depending on design and is usually not known.

Another way of calculating T_J is by using the solder point temperature, T_S as follows:

$$T_J = T_S + R_{\theta J-S} \times I_F \times V_{Fmax}$$

where:

T_S = LED solder point temperature as shown in the following figure ($^{\circ}C$)

$R_{\theta J-S}$ = Thermal resistance from junction to solder point ($^{\circ}C/W$)

I_F = Forward current (A)

V_{Fmax} = Maximum forward voltage (V)

Figure 27: Solder Point Temperature on PCB

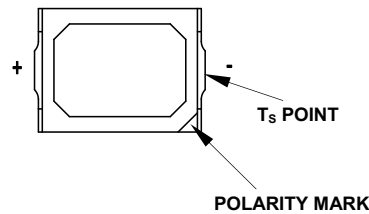

T_S can be easily measured by mounting a thermocouple on the soldering joint as shown in preceding figure, while $R_{\theta J-S}$ is provided in the data sheet. Verify the T_S of the LED in the final product to ensure that the LEDs are operating within all maximum ratings stated in the data sheet.

Eye Safety Precautions

LEDs may pose optical hazards when in operation. Do not look directly at operating LEDs because it might be harmful to the eyes. For safety reasons, use appropriate shielding or personal protective equipment.

Disclaimer

Broadcom's products and software are not specifically designed, manufactured, or authorized for sale as parts, components, or assemblies for the planning, construction, maintenance, or direct operation of a nuclear facility or for use in medical devices or applications. The customer is solely responsible, and waives all rights to make claims against Broadcom or its suppliers, for all loss, damage, expense, or liability in connection with such use.

Copyright © 2021–2022 Broadcom. All Rights Reserved. The term “Broadcom” refers to Broadcom Inc. and/or its subsidiaries. For more information, go to www.broadcom.com. All trademarks, trade names, service marks, and logos referenced herein belong to their respective companies.

Broadcom reserves the right to make changes without further notice to any products or data herein to improve reliability, function, or design. Information furnished by Broadcom is believed to be accurate and reliable. However, Broadcom does not assume any liability arising out of the application or use of this information, nor the application or use of any product or circuit described herein, neither does it convey any license under its patent rights nor the rights of others.

