

MAX5996A/MAX5996B/ MAX5996C Evaluation Kit

Evaluates: MAX5996A/
MAX5996B/MAX5996C

General Description

The MAX5996A/MAX5996B/MAX5996C evaluation kit (EV kit) is a fully assembled and tested surface-mount circuit board featuring an Ethernet port, network powered-device (PD) interface controller circuit for -57V supply rail systems. The EV kit uses the MAX5996C IEEE® 802.3af/at/bt-compliant network PD interface controller in a 16-pin TQFN package with an exposed pad. The IC is used in Power-over-Ethernet (PoE) applications requiring DC power from an Ethernet network port for PDs such as VoIP phones, wireless access nodes, security cameras, lighting, and building automation.

The EV kit receives power from IEEE 802.3af/at/bt-compliant power-sourcing equipment (PSE). The PSE provides the required -36V to -57V DC power over an unshielded twisted-pair Ethernet network cable to the EV kit's RJ45 magnetic jack. The EV kit features a 1 x 1 Gigabit RJ45 magnetic jack for separating the DC power provided by an endspan or midspan Ethernet system.

The EV kit can also be powered by a wall adapter power source. The EV kit provides PCB pads to accept the output of a wall adapter power source. When a wall adapter power source is detected, it always takes precedence over the PSE source and allows the wall adapter to power the EV kit.

The EV kit demonstrates the full functionality of the IC, such as PD detection signature, PD classification signature, Multi-Event Classification, Power/Current limiting, Power telemetry report, LLDP reclassification, Intelligent MPS, inrush current control, input undervoltage lockout (UVLO), and DC-DC step-down converter. The step-down converter operates at a fixed 395kHz switching frequency and is configured for an isolated active-clamped forward topology with output voltage +12V DC that can deliver 5.5A of current.

Features and Benefits

- IEEE 802.3af/at/bt-Compliant PD Interface Circuit
- Multi-Event Classification 0-8
- -36V to -57V Input Range
- Demonstrates a 51W PD Design with Isolated Flyback DC-DC Converter
- +12V Output at 5.5A
- Startup Inrush Current Limit of 135mA (typ)
- Power Telemetry Through MEC
- Power/Current Limiting
- LLDP Reclassification
- Current Limit During Normal Operation
- Evaluates Endspan and Midspan Ethernet Systems
- Type 1-4 PSE Classification Indicator
- Simplified Wall Adapter Interface
- Demonstrates Sleep and Ultra-Sleep Power-Saving Modes
- Proven PCB Layout
- Fully Assembled and Tested

[Ordering Information](#) appears at end of data sheet

MAX5996 EV Kit Board Photo

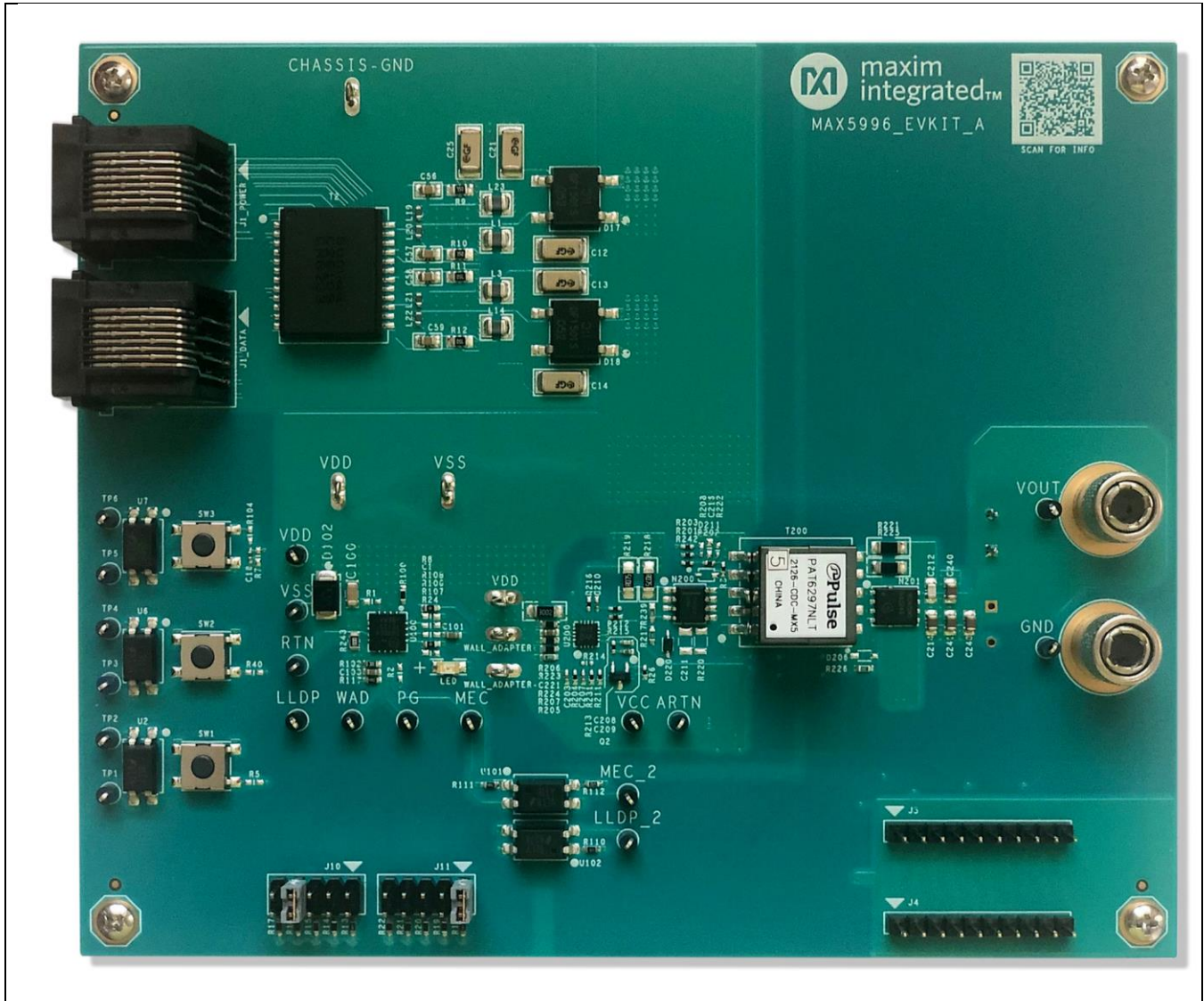

Table 1. Jumper Connection Guide

JUMPER	DEFAULT CONNECTION	FEATURE
J10	Pin 1 – Pin 2	Connect R _{CLSB} to 30.9Ω
J11	Pin 1 – Pin 2	Connect R _{CLSA} to 30.9Ω

Quick Start

Required Equipment

- MAX5996_EVKIT_A
- An IEEE 802.3af/at/bt compliant PSE and a Category 5e Ethernet network cable
- -48V, 3A capable DC power supply, voltmeter

Procedure

The EV kit is fully assembled and tested. Follow the steps to verify board operation:

Caution: Do not turn on the power supply until all the connections are completed.

- 1) Use one of the following methods to power the EV kit:
 - a) **If network connectivity is required:** Connect a Category 5e Ethernet network cable from the EV kit input port (J1_POWER) RJ45 connector to the corresponding PSE Ethernet LAN connection that provides power to the EV kit.
 - b) **If network connectivity is not required:** Connect a -48V DC power supply between the VDD and VSS PCB pads on the EV kit. Connect the power-supply positive terminal to the VDD pad and the negative terminal to the VSS pad.
- 2) Activate the PSE power supply or turn on the external DC power supply.
- 3) Using a voltmeter, verify that the EV kit provides +12V across the V_{OUT} and GND PCB pads.

Detailed Description of Hardware

The MAX5996A/MAX5996B/MAX5996C EV kit features an Ethernet port and network PD interface controller circuit for -57V supply rail systems. The EV kit contains an IEEE® 802.3af/at/bt compliant network PD interface controller in a 16-pin TQFN-EP package. The IC is used in PoE applications for powering PDs from an unshielded twisted-pair (UTP) Ethernet Category 5e network cable and PSE port using endspan or midspan Ethernet systems.

The EV kit receives power from an IEEE® 802.3af/at/bt-compliant PSE and a UTP cable connected to the EV kit's RJ45 magnetic jack. The EV kit uses a 1 x 1-gigabit RJ45 magnetic jack to separate the -57V DC power sent by the PSE. The EV kit can accept power from an endspan or midspan PSE network configuration.

The EV kit can also accept power from a wall adapter power source. When a wall adapter power source is detected between the WALL_ADAPTER+ and WALL_ADAPTER - pads, the IC's internal isolation switch disconnects, which allows the wall adapter to supply power to the EV kit.

The EV kit demonstrates the full functionality of the IC such as PD detection signature, PD classification signature, Multi-Event Classification, Power Telemetry report, Power/current limiting, LLDP Reclassification, Intelligent MPS, inrush current control, and UVLO. Resistor R100 sets the PD detection impedance. Jumper J10 and J11 set the PD classification signatures.

The EV kit's integrated DC-DC step-down converter is configured for an isolated Flyback converter topology with the output voltage of +12V and provides up to 5A at the output while achieving up to 92.5%, 92.4%, and 92% efficiencies for 42V/48V/57V input, respectively. The step-down converter operates at a fixed 395kHz switching frequency.

The EV kit has the option to install the MAX32625PICO board on J4 and J5 to demonstrate MEC power telemetry, class info report, and LLDP functions from GUI in a PC.

PD Class selection by Classification resistors

By selecting the two external resistors connected to CLSA and CLSB pins, the power consumption requested by the PD can be defined. [Table 2](#) shows the R_{CLSA} and R_{CLSB} resistor values needed to set for the PD class and the PD power consumption defined by standards. R_{CLSA} sets classification current for the 1st and 2nd class Events for 0~4 class PD compliant with IEEE 802.3af/at standard, and R_{CLSB} set classification current for the 3rd to 5th class event for 0~8 class PD compliant with IEEE 802.3bt standard.

Table 2. PSE Type and PD Class with Classification Resistor R_{CLSA} and R_{CLSB}

PD CLASS	POWER REQUESTED BY PD	RCLSA	RCLSB
0	12.95W	619	OPEN
1	3.84W	118	OPEN
2	6.49W	66.5	OPEN
3	12.95W	43.2	OPEN
4	25.5W	30.9	30.9
5	38.25W	30.9	619

Wall Adapter Power Source (WALL_ADAPTER+, WALL_ADAPTER)

The EV kit can also accept power from a wall adapter power source. Use the WALL_ADAPTER+ (0V) and WALL_ADAPTER- (-10V to -57V) PCB pads to connect the wall adapter power source. The wall adapter power source operating- voltage range must be within +10V to +57V for the EV kit.

When the wall adapter power source is above +10V it always takes precedence over the PSE source. Once the wall adapter power source is detected, the IC's internal isolation switch disconnects. The wall adapter power is supplied to VDD through diode D103. Once it takes over, the classification process is disabled.

When the wall adapter power source is below +8V, the PSE provides power through the IC's internal isolation switch. Diode D103 prevents the PSE from back-driving the wall adapter power source when it is below +8V.

Undervoltage Lockout (UVLO)

The EV kit operates up to a -57V supply with a turn-on UVLO threshold (V_{ON}) at -35.4V and a turn-off UVLO threshold (V_{OFF}) at -30.0V. When the input voltage is above V_{ON} , the EV kit is enabled. When the input voltage goes below V_{OFF} , the EV kit is disabled.

Class Info and Power Telemetry Report

The EV kit can demonstrate Class info and real- time power telemetry report through the MEC pin of the MAX5996C. Users can apply electronic load on J8 and J9 and increase output power to evaluate the power or current limiting function of the MAX5996C device with the MAX5974 dc-dc converter. Probing MEC pin and LLDP pin can monitor patterned pulses in the scope to evaluate power telemetry reading and LLDP data pulses configuration.

Users can also use the MAX32625PICO micro-controller board to demonstrate MEC and LLDP functions.

Power Limit and Current Limit (MAX5996C)

The EV kit supports operating the MAX5996C in power limiting or current limiting mode. Change the resistor connection on J10 and J11 to configure the device in a certain Class level. Monitor the MEC pin to read back real-time power consumption for the device to evaluate the power/current limiting functions of the MAX5996C.

LLDP Reclassification (MAX5996C)

The EV kit can demonstrate the LLDP function by apply patterned pulses on the LLDP pin. Using the MAX32625PICO board users can easily configure the required power limit and current limit in the GUI and send pulses through the MAX32625PICO to the LLDP pin of the MAX5996C, to overwrite the power or current limit level in the MAX5996C.

MAX32625PICO Board Option

The EV kit has an option of the MAX32625PICO microcontroller board on Header J4 and J5. The MAX32625PICO board can be used to evaluate MAX5996C MEC pin Class info and power telemetry function and LLDP power/current limit configuration function with downloaded firmware and the GUI. Note the MAX32625PICO has to be soldered on J4 and J5 connectors to function with the MAX5996C. The MAX32625PICO EV kit can be ordered at the link:

<https://www.maximintegrated.com/en/products/microcontrollers/MAX32625PICO.html#tech-docs>

The GUI of the MAX32625PICO can be downloaded from https://ci-mss.maxim-ic.com/job/CnD/job/max5996_gui/108/ and the firmware of the MAX32625PICO board can be downloaded from https://ci-mss.maxim-ic.com/job/CnD/job/max5996_fw/115/. Refer to MAX32625PICO EV kit datasheet for programming MAX32625PICO board with the downloaded firmware file.

1. Visit www.maximintegrated.com/products/MAX5996 under the *Design & Development* tab to download the latest version of the MAX5996 EV kit software. Save the software to a temporary folder and unpack the zip file.
2. Install the EV kit software on the computer by running the **MAX5996EVKitGUISetup_v1.0.108.exe** program inside the temporary folder. This copies the program files and creates an icon in the Windows **Start** menu.

Sleep, Ultra-Sleep Modes, and LED Operation (MAX5996A/B)

The EV Kit supports operating the MAX5996A/B in power-saving modes such as the Sleep and Ultra-Lower-Power Sleep. By using the SW3 DIP switch, the \overline{SL} pin could be driven low to enter the Sleep mode. The Ultra-Lower-Power Sleep mode could be entered by driving both \overline{SL} and \overline{ULP} pin to low (using DIP switch SW1, SW3). The device could be commanded to exit sleep or Ultra-Lower-Power mode by driving the \overline{WK} pin low through the switch SW2.

The device features a dedicated LED pin that can be programmed to source out current when the device is in MPS, sleep, or ultra-sleep modes. Diode named LED connects between the LED pin and V_{SS} and lights up in green color to indicate LED current. The magnitude of the LED current can be controlled as per the value of the R7 resistor connected between the \overline{SL} pin and V_{SS} .

EV Kit Compliance to MAX5996A, MAX5996B

By default, the EV kit is installed with MAX5996C IC. The EV kit can also be used to evaluate the MAX5996A and MAX5996B variants of the IC when installing R5, R40, R104, R7, R24 and remove R8, R106, R107.

Detailed Description of Software

In the MAX5996A/MAX5996B/MAX5996C GUI, make sure the MAX32625PICO board is connected to the PC USB port via a cable. Click on the **Connection drop** list and select **COM5** and then click on **Connect** button to connect the MAX32625PICO board. When the board is connected, the **Status** window on the bottom of the GUI shows **Connected to PICO (COM5)**.

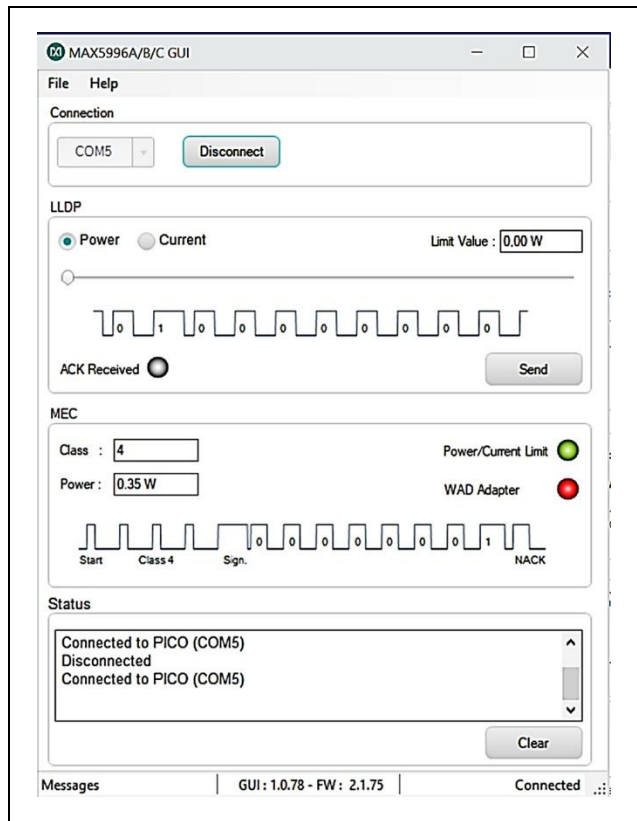

Figure 1. GUI reads power level and indicates **Power Limit**.

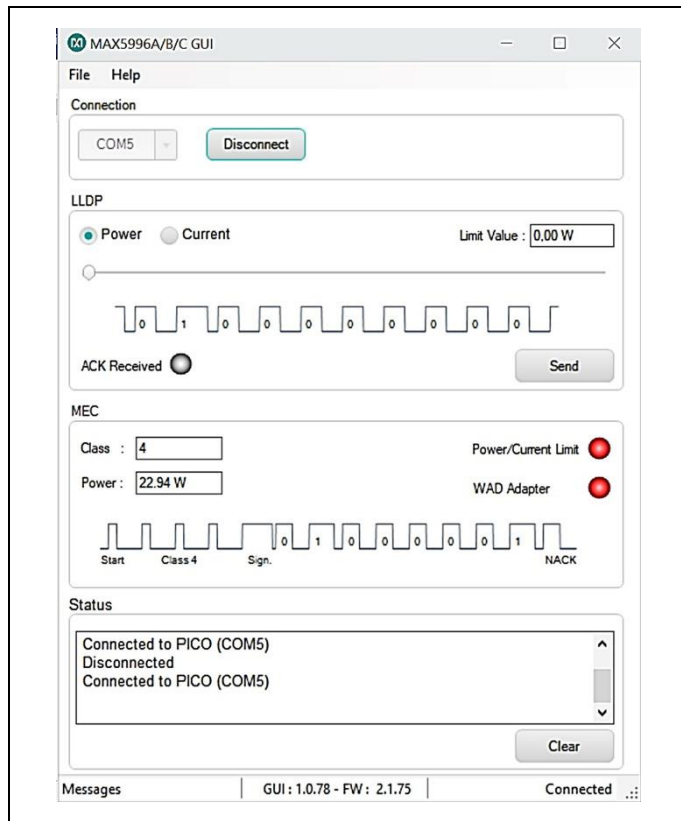

Figure 2. GUI reads power level and indicates **Power Limit**.

When the PICO board is connected the GUI is ready to operate. In **MEC** section of the GUI, Class info and Power telemetry are reported according to MEC pin status. The MEC pin patterned pulses are read back and shown on the GUI. When the load is increased and causes the power level reaching the limit, the light of **Power/Current Limit** turns **Red**. If the wall adaptor is plugged in and the MOSFET is turned off, the light of **WAD Adaptor** will turn **Green**.

In the LLDP section, select **Power** or **Current** to configure the power limit or current limit to send out. Move the progress bar to change the Power or Current limits and press the **Send** button to send out the LLDP data frame to the LLDP pin of the MAX5996C.

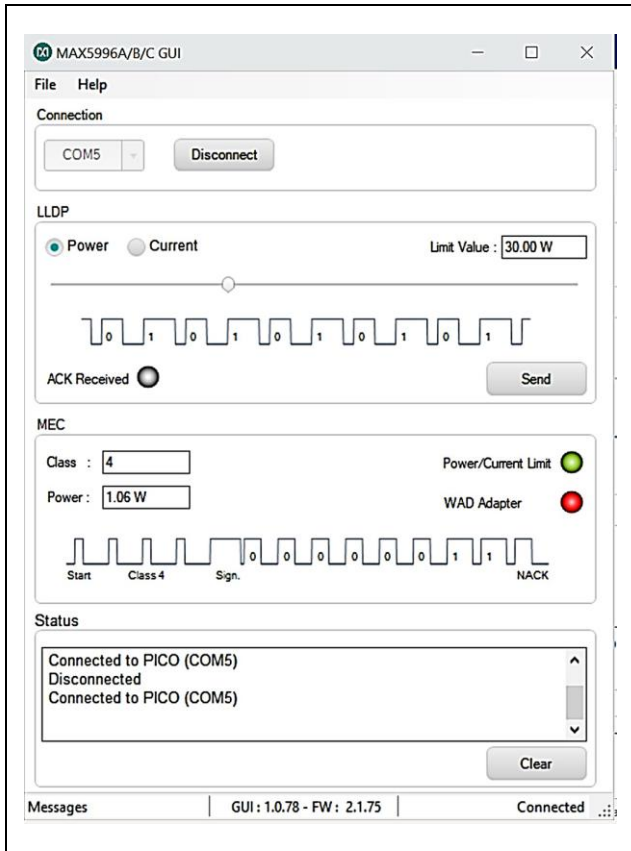

Figure 3. Configure LLDP power level.

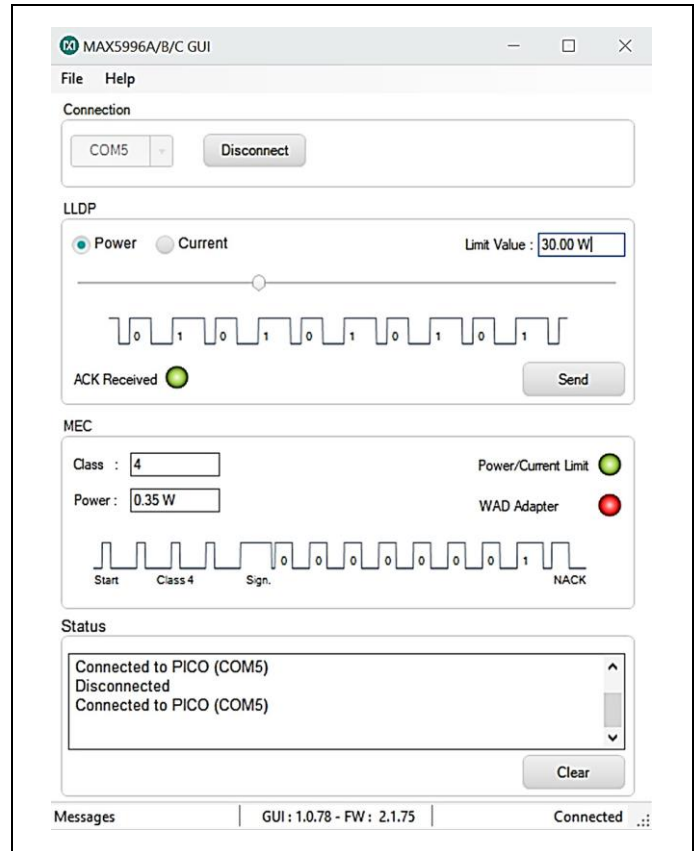

Figure 4. Send LLDP power level and ACK light indicates acknowledge.

Ordering Information

PART	TYPE
MAX5996CEVKIT#	EV Kit

#Denotes RoHS-compliant.

MAX5996A/MAX5996B/MAX5996C EV Kit Bill of Materials

PART	QTY	MANUFACTURER PART NUMBER	DESCRIPTION
C2	1	C0402C561K5GAC	CAP; SMT (0402); 560PF; 10%; 50V; COG; CERAMIC
C12-C14, C21, C25	5	GA352QR7GF102KW01	CAP; SMT (2211); 1000PF; 10%; 250V; X7R; CERAMIC
C18	1	TMK105BJ104KV	CAP; SMT (0402); 0.1UF; 10%; 25V; X5R; CERAMIC
C56-C59	4	C0805C103K1RAC	CAP; SMT (0805); 0.01UF; 10%; 100V; X7R; CERAMIC
C100	1	C1206C104K1RAC	CAP; SMT (1206); 0.1UF; 10%; 100V; X7R; CERAMIC
C101	1	C0603C473K1RAC	CAP; SMT (0603); 0.047UF; 10%; 100V; X7R; CERAMIC
C103	1	CGA3E2X7R2A103K	CAP; SMT (0603); 0.01UF; 10%; 100V; X7R; CERAMIC;
C200, C206, C213	3	C1206C222MGRAC	CAP; SMT (1206); 2200PF; 20%; 2000V; X7R; CERAMIC
C201	1	EEE-FK1K470P	CAP; SMT (CASE_G); 47UF; 20%; 80V; ALUMINUM-ELECTROLYTIC
C202, C205, C211, C215, C223	5	C3216X7R2A105K160AA	CAP; SMT (1206); 1UF; 10%; 100V; X7R; CERAMIC
C203	1	C1005X7R1E473K050BC	CAP; SMT (0402); 0.047UF; 10%; 25V; X7R; CERAMIC
C204, C218	2	GRM32ER71E226KE15	CAP; SMT (1210); 22UF; 10%; 25V; X7R; CERAMIC
C208	1	C0402C101K5GAC	CAP; SMT (0402); 100PF; 10%; 50V; COG; CERAMIC
C209	1	C1005X7R1H473K	CAP; SMT (0402); 0.047UF; 10%; 50V; X7R; CERAMIC
C210	1	C0402C331J5GAC	CAP; SMT (0402); 330PF; 5%; 50V; COG; CERAMIC
C212	1	C0805C221J2GAC	CAP; SMT (0805); 220PF; 5%; 200V; COG; CERAMIC
C214, C240, C241, C243	4	GRM21BZ71E106KE15	CAP; SMT (0805); 10UF; 10%; 25V; X7R; CERAMIC; NOTE: PURCHASE DIRECT FROM THE MANUFACTURER
C217, C222	2	C1608X7R1E104K080AA	CAP; SMT (0603); 0.1UF; 10%; 25V; X7R; CERAMIC
C221	1	GRM188R71C474KA88	CAP; SMT (0603); 0.47UF; 10%; 16V; X7R; CERAMIC
C224	1	0603YC101KAT2A	CAP; SMT (0603); 100PF; 10%; 16V; X7R; CERAMIC
C226	1	GRM188R71C563KA01	CAP; SMT (0603); 0.056UF; 10%; 16V; X7R; CERAMIC
C242	1	16SP270M	CAP; THROUGH HOLE-RADIAL LEAD; 270UF; 20%; 16V; ELECTROLYTIC-OSCON
D17, D18	2	DF1501S	DIODE; RECT; SMT; PIV=100V; IF=1.5A
D102		SMBJ58A-13-F	DIODE; TVS; SURFACE MOUNT TRANSIENT VOLTAGE SUPPRESSOR; SMB; PIV=58V; IF=100A
D103		B360B-13-F	DIODE; SCH; SCHOTTKY BARRIER DIODE; SMB; PIV=60V; I _o =3A; -55 DEGC TO +125 DEGC
D200		1N4148WSF	DIODE; SWT; SMT (SOD-323F); PIV=100V; IF=0.25A
D201	1	BZT52C18S-7-F	DIODE; ZNR; SURFACE MOUNT ZENER DIODE; SMT (SOD-323); PIV=18V; IF=0.05A
D206, D212, D220	3	B5819WS	DIODE; SCH; SOD-323; PIV=40V; IF=1A
D210	1	BAT54S	DIODE; SCH; SCHOTTKY DIODE; SMT (SOT-23); PIV=30V; IF=0.2A
H1-H4	4	2203	STANDOFF; FEMALE-THREADED; HEX; 4-40; 1/2IN; ALUMINUM

MAX5996A/MAX5996B/
MAX5996C Evaluation Kit

Evaluates: MAX5996A/
MAX5996B/MAX5996C

PART	QTY	MANUFACTURER PART NUMBER	DESCRIPTION
H5-H8	4	4C25MXPS	MACHINE SCREW; PHILLIPS; PAN; 4-40; 1/4IN; 18-8 STAINLESS STEEL
J1_DATA, J1_POWER	2	5520252-4	CONNECTOR; FEMALE; THROUGH HOLE; MODULAR JACK ASSEMBLY; KEYED; FLANGELESS; WITH PANEL STOP; RIGHT ANGLE; 8PINS
J4, J5	2	TSW-110-07-F-S	CONNECTOR; MALE; THROUGH HOLE; 0.025 IN SQ POST HEADER; STRAIGHT; 10PINS
J8, J9	2	111-2223-001	MACHINE SCREW; THUMBSCREW; BANANA; 1/4-32IN; 11/32IN; NICKEL PLATED BRASS
J10, J11	2	61301021121	CONNECTOR; MALE; THROUGH HOLE; 2.54 DUAL PIN HEADER; STRAIGHT; 10PINS
L1-L3, L14, L16, L18, L23, L24	8	LQM2HPN4R7MG0	INDUCTOR; SMT (1008); FERRITE; 4.7UH; 20%; 1.10A
L19-L22	4	BLM18EG221SN1	INDUCTOR; SMT (0603); FERRITE-BEAD; 220; TOL=+/-25%; 2A
L200	1	SD53-3R3-R	INDUCTOR; SMT; FERRITE BOBBIN CORE; 3.3UH; TOL=+/-20%; 2.6A
LED	1	LTST-C150GKT	DIODE; LED; ; SMT (1206); VF=2.1V; IF=0.03A; -55 DEGC TO +85 DEGC; GREEN
LLDP, MEC, MEC_2, PG, VCC, VDD, VOUT, WAD	8	5001	TEST POINT; PIN DIA=0.1IN; TOTAL LENGTH=0.3IN; BOARD HOLE=0.04IN; BLACK;
N200	1	FDS86242	TRAN; N-CHANNEL POWER TRENCH MOSFET; NCH; SO-8; PD-(5W); I-(4.1A); V-(150V)
N201	1	BSC160N15NS5ATMA1	TRAN; NCH; PG-TDSON8; PD-(96W); I-(56A); V-(150V)
R3, R202, R203, R211, R216	5	ERJ-2GE0R00	RES; SMT (0402); 0; JUMPER; JUMPER; 0.1000W
R8, R107	2	RC1608J000CS	RES; SMT (0603); 0; 5%; JUMPER; 0.1000W
R9-R12	4	RMCF0805JT75R0	RES; SMT (0805); 75; 5%; +/-200PPM/DEGC; 0.1250W
R13, R18	2	CRCW060330R9FK	RES; SMT (0603); 30.9; 1%; +/-100PPM/DEGC; 0.1000W
R15, R20	2	TNPW060366R5BE	RES; SMT (0603); 66.5; 0.10%; +/-25PPM/DEGK; 0.1000W
R16, R21	2	CRCW0603115RFB	RES; SMT (0603); 115; 1%; +/-100PPM/DEGC; 0.1000W
R17, R22	2	CRCW0603619RFB	RES; SMT (0603); 619; 1%; +/-100PPM/DEGC; 0.1000W
R100	1	CRCW060324K9FK	RES; SMT (0603); 24.9K; 1%; +/-100PPM/DEGC; 0.1000W
R102	1	RC0603FR-0720KL	RES; SMT (0603); 20K; 1%; +/-100PPM/DEGC; 0.1000W
R110	1	CRCW0603511RFB	RES; SMT (0603); 511; 1%; +/-100PPM/DEGC; 0.1000W
R111, R117, R240	3	CRCW060349K9FK	RES; SMT (0603); 49.9K; 1%; +/-100PPM/DEGC; 0.1000W
R112	1	ERJ-3GEYJ472	RES; SMT (0603); 4.7K; 5%; +/-200PPM/DEGC; 0.1000W
R200	1	TNPW080510R0BE	RES; SMT (0805); 10; 0.10%; +/-25PPM/DEGC; 0.1250W
R201	1	CRCW040223K2FK; RC0402FR-0723K2L	RES; SMT (0402); 23.2K; 1%; +/-100PPM/DEGK; 0.0630W
R204	1	CRCW040216K9FK; ERJ-2RKF1692	RES; SMT (0402); 16.9K; 1%; +/-100PPM/DEGK; 0.1000W

MAX5996A/MAX5996B/
MAX5996C Evaluation Kit

Evaluates: MAX5996A/
MAX5996B/MAX5996C

PART	QTY	MANUFACTURER PART NUMBER	DESCRIPTION
R205, R239	2	TNPW060334K0BE	RES; SMT (0603); 34K; 0.10%; +/-100PPM/DEGC; 0.1000W
R206	1	CRCW120630K0FK	RES; SMT (1206); 30K; 1%; +/-100PPM/DEGC; 0.2500W
R207	1	CRCW06031M50FK	RES; SMT (0603); 1.5M; 1%; +/-100PPM/DEGC; 0.1000W
R208	1	CRCW04025K10FK	RES; SMT (0402); 5.1K; 1%; +/-100PPM/DEGC; 0.0630W
R210, R227, R235	3	ERJ-2GEJ103	RES; SMT (0402); 10K; 5%; +/-200PPM/DEGC; 0.1000W
R212	1	ERJ-2RKF4990	RES; SMT (0402); 499; 1%; +/-100PPM/DEGC; 0.1000W
R213	1	ERA-2AEB202	RES; SMT (0402); 2K; 0.10%; +/-25PPM/DEGC; 0.0630W
R215	1	CRCW04024K02FK	RES; SMT (0402); 4.02K; 1%; +/-100PPM/DEGC; 0.0630W
R217, R226	2	TNPW060310R0BE	RES; SMT (0603); 10; 0.10%; +/-25PPM/DEGC; 0.1000W
R218, R219	2	WSL1206R0400F	RES; SMT (1206); 0.04; 1%; +/-75PPM/DEGC; 0.2500W
R221, R225	2	CRCW120620R0FK	RES; SMT (1206); 20; 1%; +/-100PPM/DEGC; 0.2500W
R223	1	CRCW0603330KFK	RES; SMT (0603); 330K; 1%; +/-100PPM/DEGC; 0.1000W
R224	1	CRCW06031212FK	RES; SMT (0603); 12.1K; 1%; +/-100PPM/DEGC; 0.1000W
R228	1	CRCW0402200KFK	RES; SMT (0402); 200K; 1%; +/-100PPM/DEGC; 0.0630W
R229	1	CRCW0402100KFK	RES; SMT (0402); 100K; 1%; +/-100PPM/DEGC; 0.0630W
R231	1	CRCW040222K0FK	RES; SMT (0402); 22K; 1%; +/-100PPM/DEGC; 0.0630W
R232-R234	3	TNPW04021K00BE	RES; SMT (0402); 1K; 0.10%; +/-25PPM/DEGC; 0.1000W
R237	1	ERJ-2RKF1004	RES; SMT (0402); 1M; 1%; +/-100PPM/DEGC; 0.1000W
R241	1	ERJ-3EKF3832	RES; SMT (0603); 38.3K; 1%; +/-100PPM/DEGC; 0.1000W
R242	1	ERJ-2RKF49R9	RES; SMT (0402); 49.9; 1%; +/-100PPM/DEGC; 0.1000W
R243	1	CR0805-10W-000	RES; SMT (0805); 0; JUMPER; JUMPER; 0.1000W
SU1, SU2	2	929953-30	CONNECTOR; FEMALE; THROUGH HOLE; 929 SERIES; SHUNT CONNECTOR; STRAIGHT; 2PINS
SW1-SW3	3	B3FS-1000P	SWITCH; SPST; SMT; 24V; 0.05A; TACTILE SURFACE MOUNT SWITCH; RCOIL= OHM; RINSULATION= OHM; OMRON
T2	1	7490220126	EVKIT PART - TRANSFORMER; 7490220126; SMT-24; SUMIDA
T200	1	PAT6297NLT	TRANSFORMER; SMT; PRIMARY=33-57V; 400KHZ; AUXILIARY=10V/0.02A; BIAS=5V/0.02A; SECONDARY=12V/3.75A; SMT 10PINS;
U2, U6, U7, U101, U102	5	FOD817ASD	IC; OPTO; 4-PIN HIGH OPERATING TEMPERATURE PHOTOTRANSISTOR OPTOCOUPLER; SMT
U5	1	ATL431AIDBZR	IC; VREF; 2.5V LOW IQ ADJUSTABLE PRECISION SHUNT REGULATOR; SOT23
U100	1	MAX5996C	EVKIT PART - IC; MAX5996C; PACKAGE OUTLINE DRAWING: 21-100484; PACKAGE LAND PATTERN: 90-100171; TQFN16-EP
U200	1	MAX5974AETE+	IC; CTRL; ACTIVE-CLAMPED; SPREAD-SPECTRUM; CURRENT-MODE PWM CONTROLLERS; TQFN16-EP
U201	1	FOD817CSD	IC; OPTO; 4-PIN DIP PHOTOTRANSISTOR OPTOCOUPLER; SMT

MAX5996A/MAX5996B/MAX5996C EV Kit Schematic Diagrams

PD INTERFACE: MAX5996C

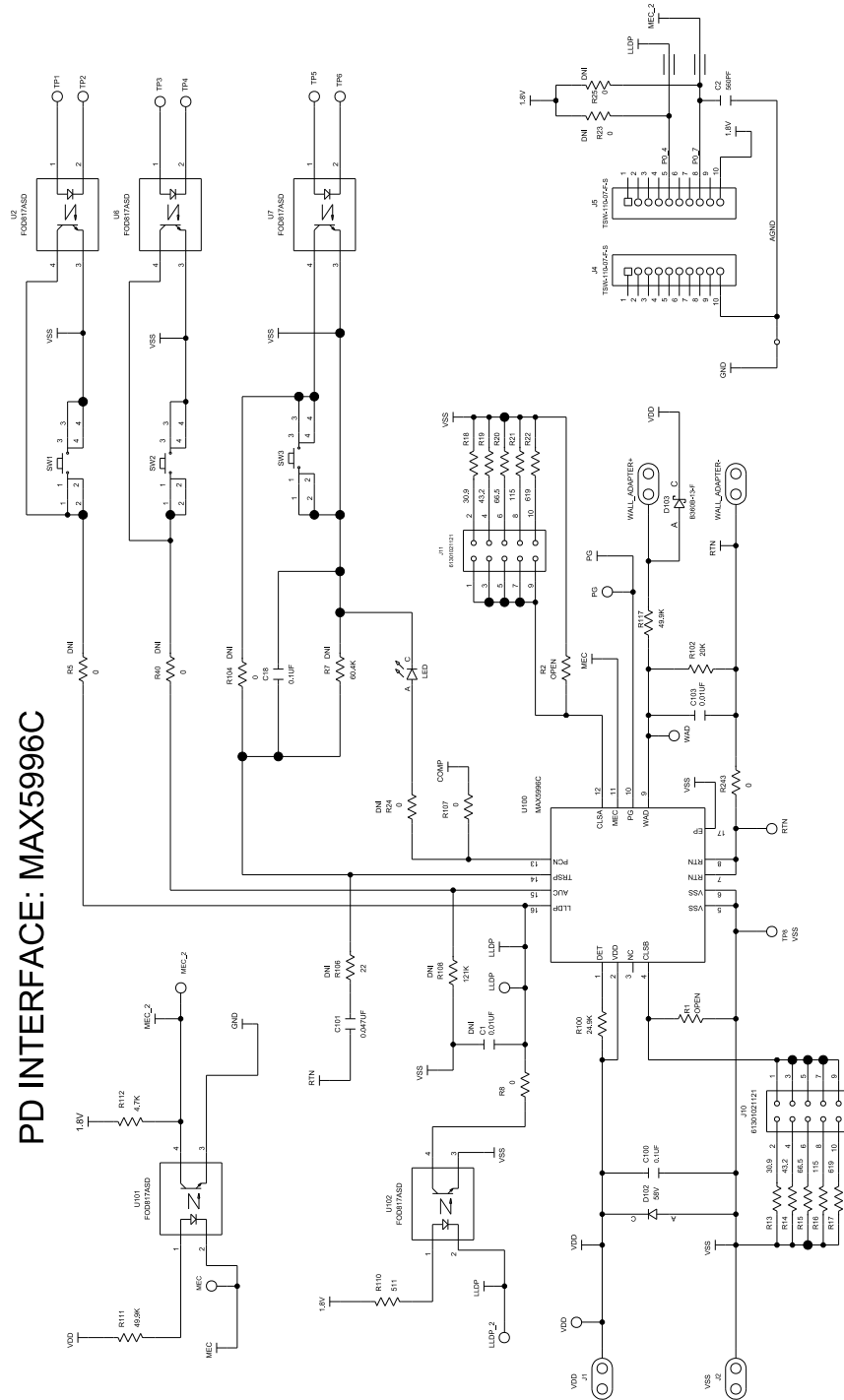

MAX5996A/MAX5996B/MAX5996C EV Kit Schematic Diagrams (continued)

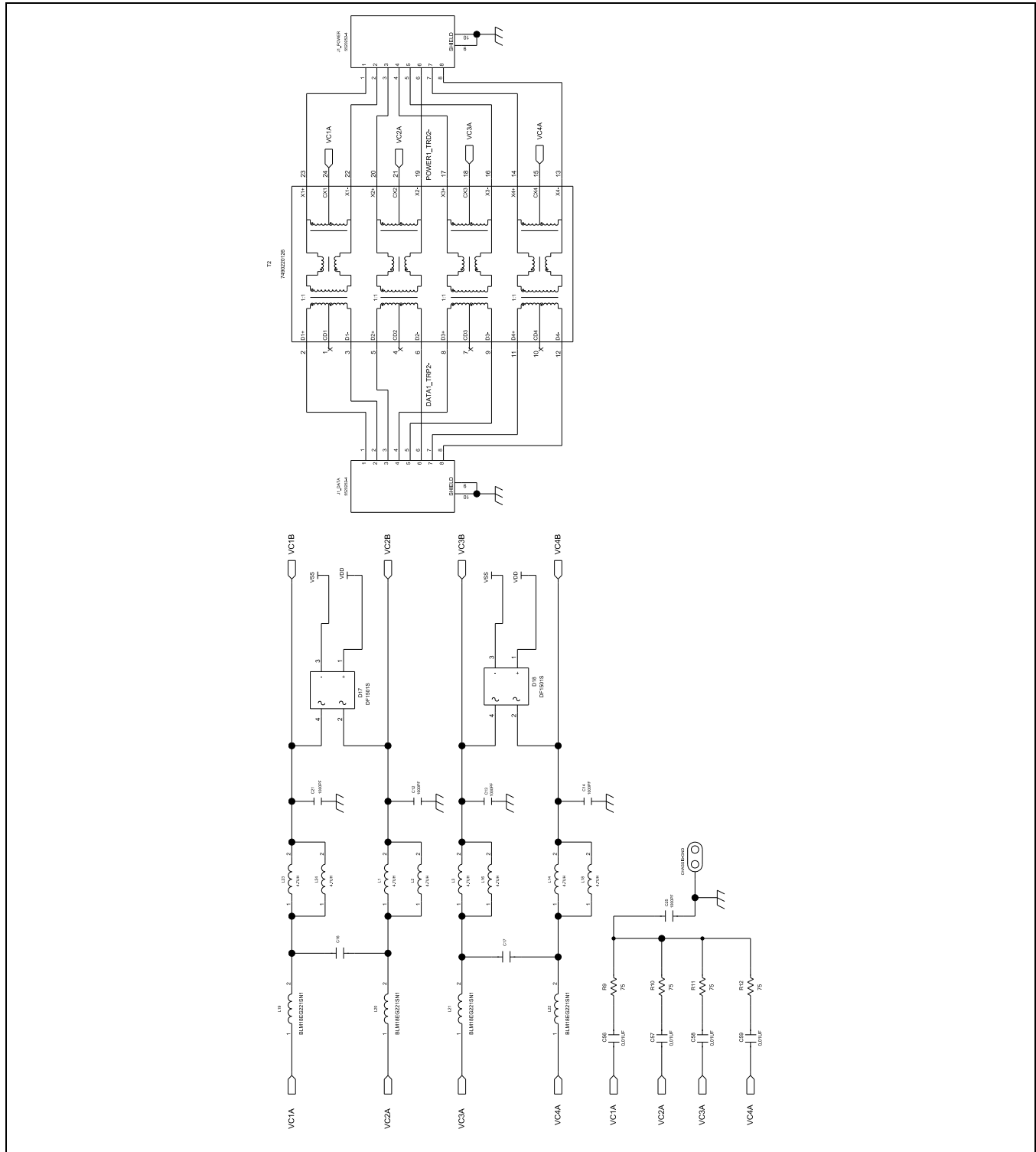

MAX5996A/MAX5996B/MAX5996C EV Kit Schematic Diagrams (continued)

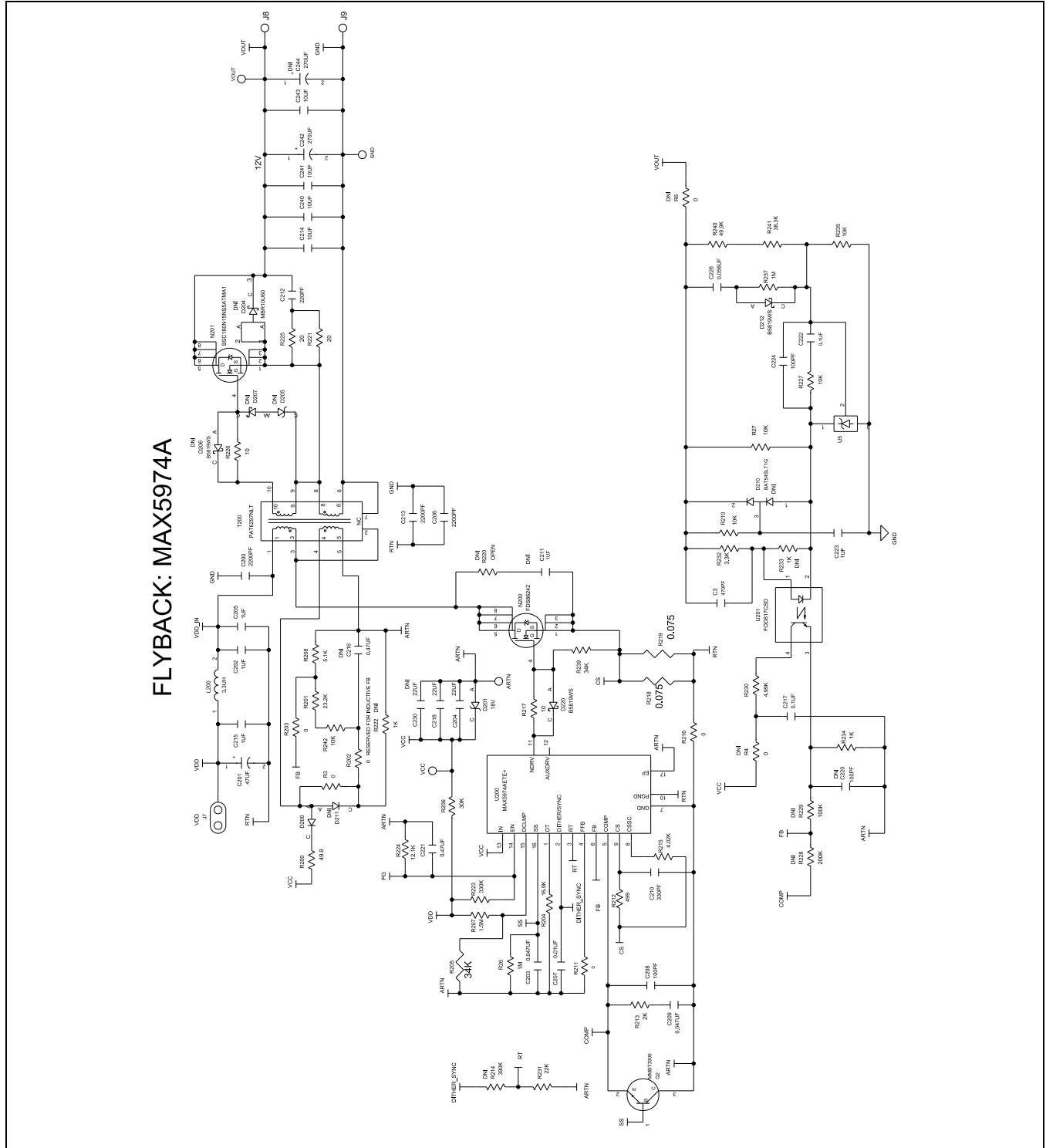

MAX5996A/MAX5996B/MAX5996C EV Kit PCB Layout Diagrams

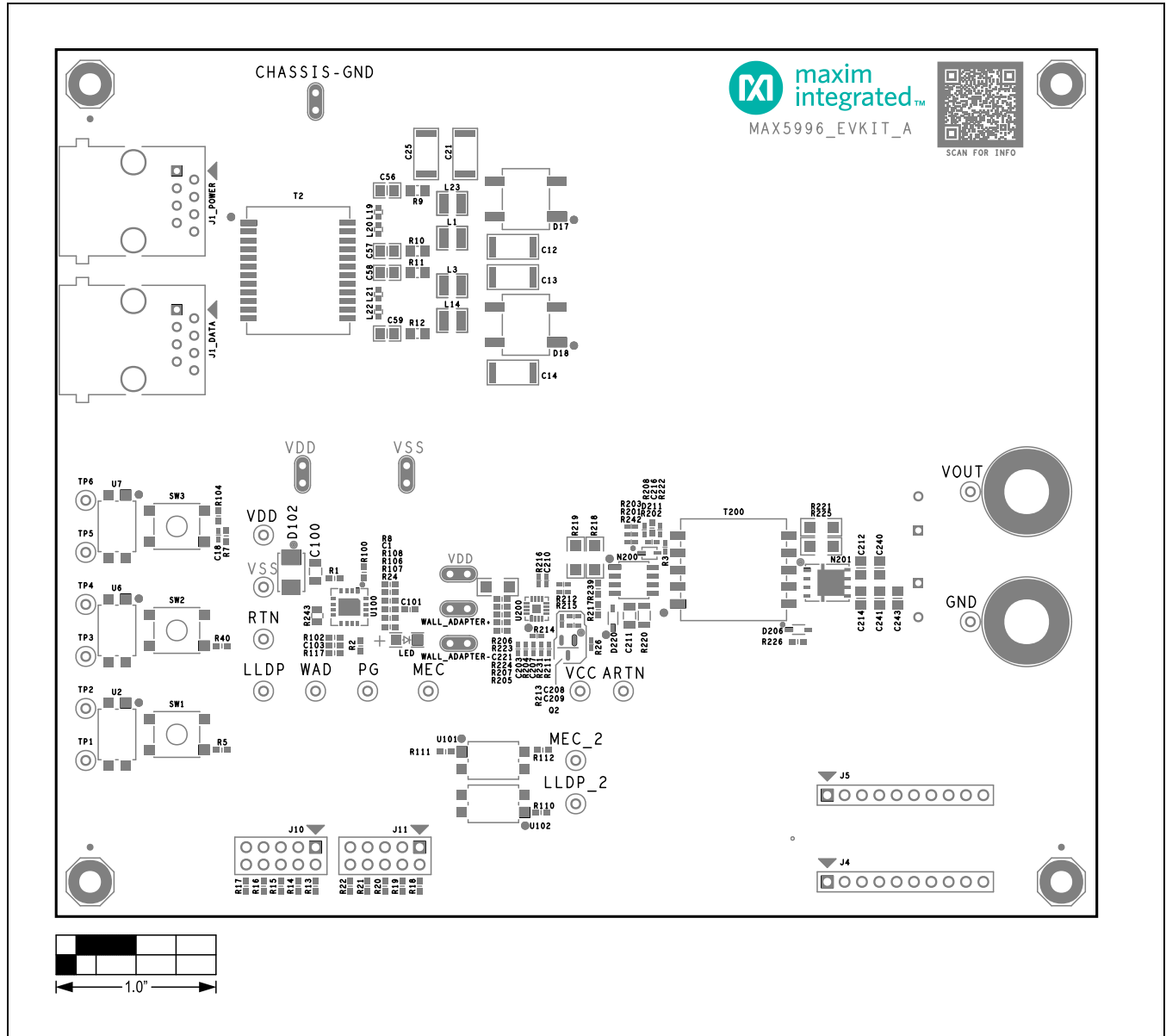

MAX5996A/MAX5996B/MAX5996C EV Kit Component Placement Guide—Top Silkscreen

MAX5996A/MAX5996B/MAX5996C EV Kit PCB Layout Diagrams (continued)

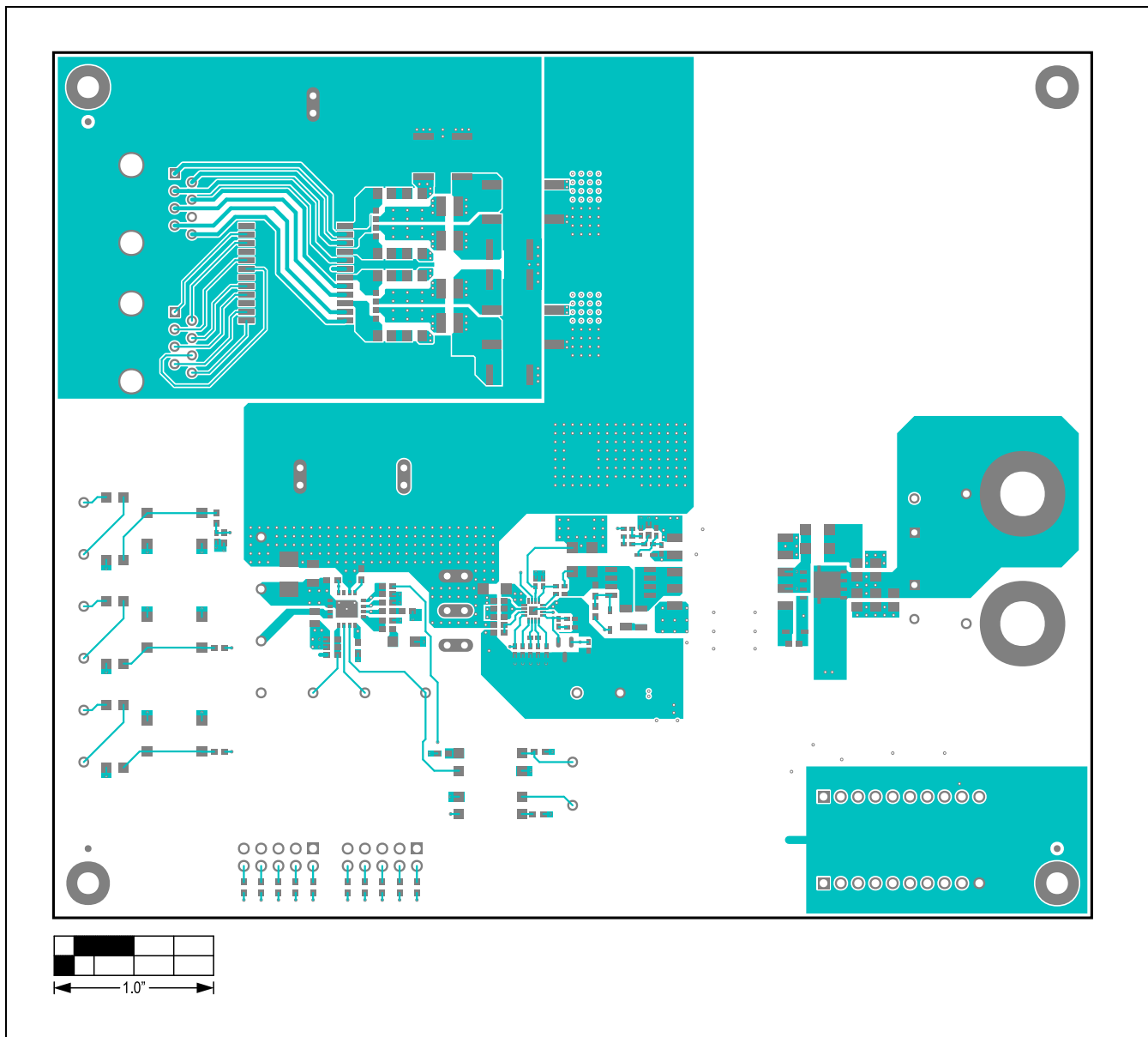

MAX5996A/MAX5996B/MAX5996C EV Kit PCB Layout—Top View

MAX5996A/MAX5996B/MAX5996C EV Kit PCB Layout Diagrams (continued)

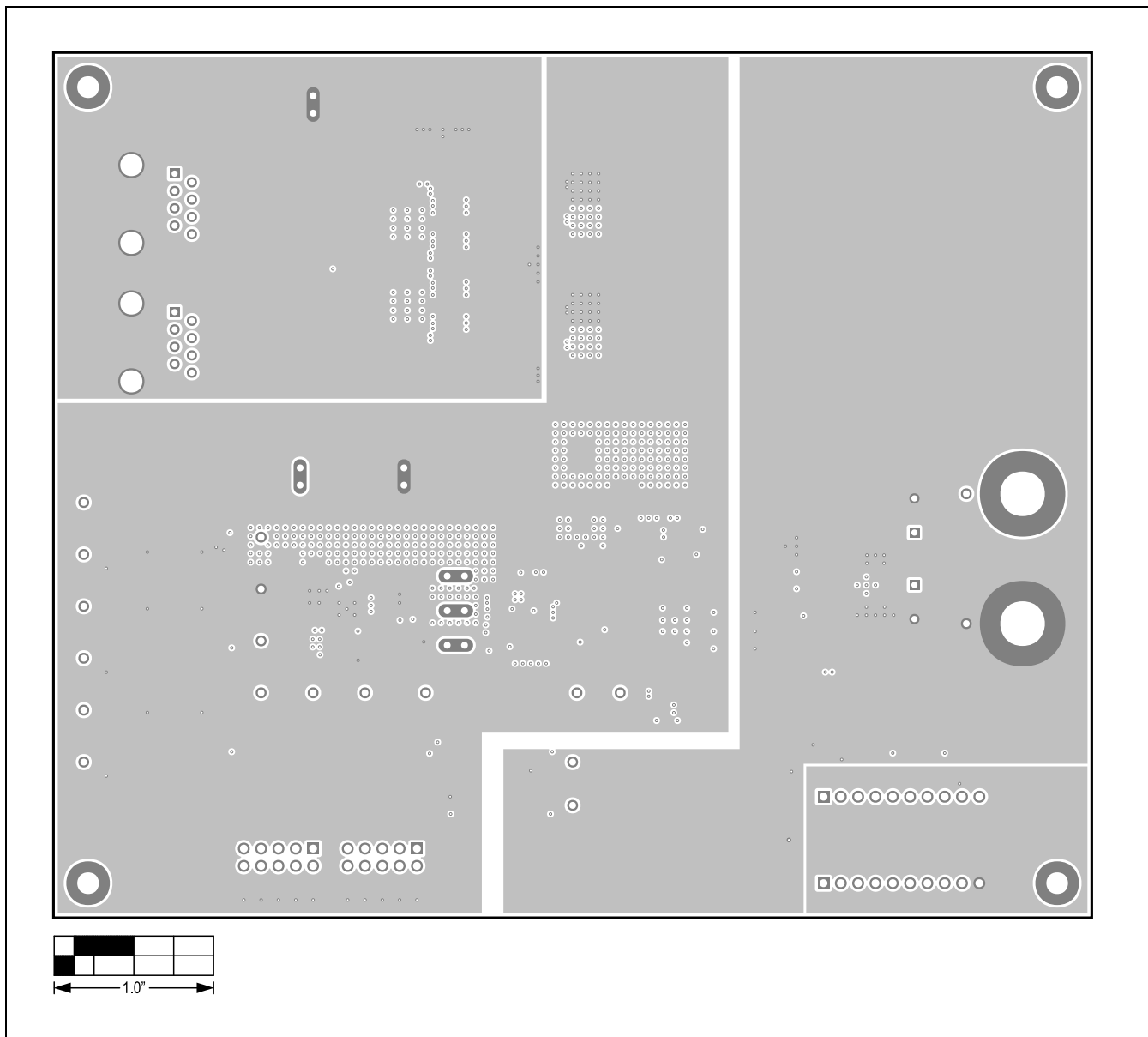

MAX5996A/MAX5996B/MAX5996C EV Kit PCB Layout—Layer 2

MAX5996A/MAX5996B/MAX5996C EV Kit PCB Layout Diagrams (continued)

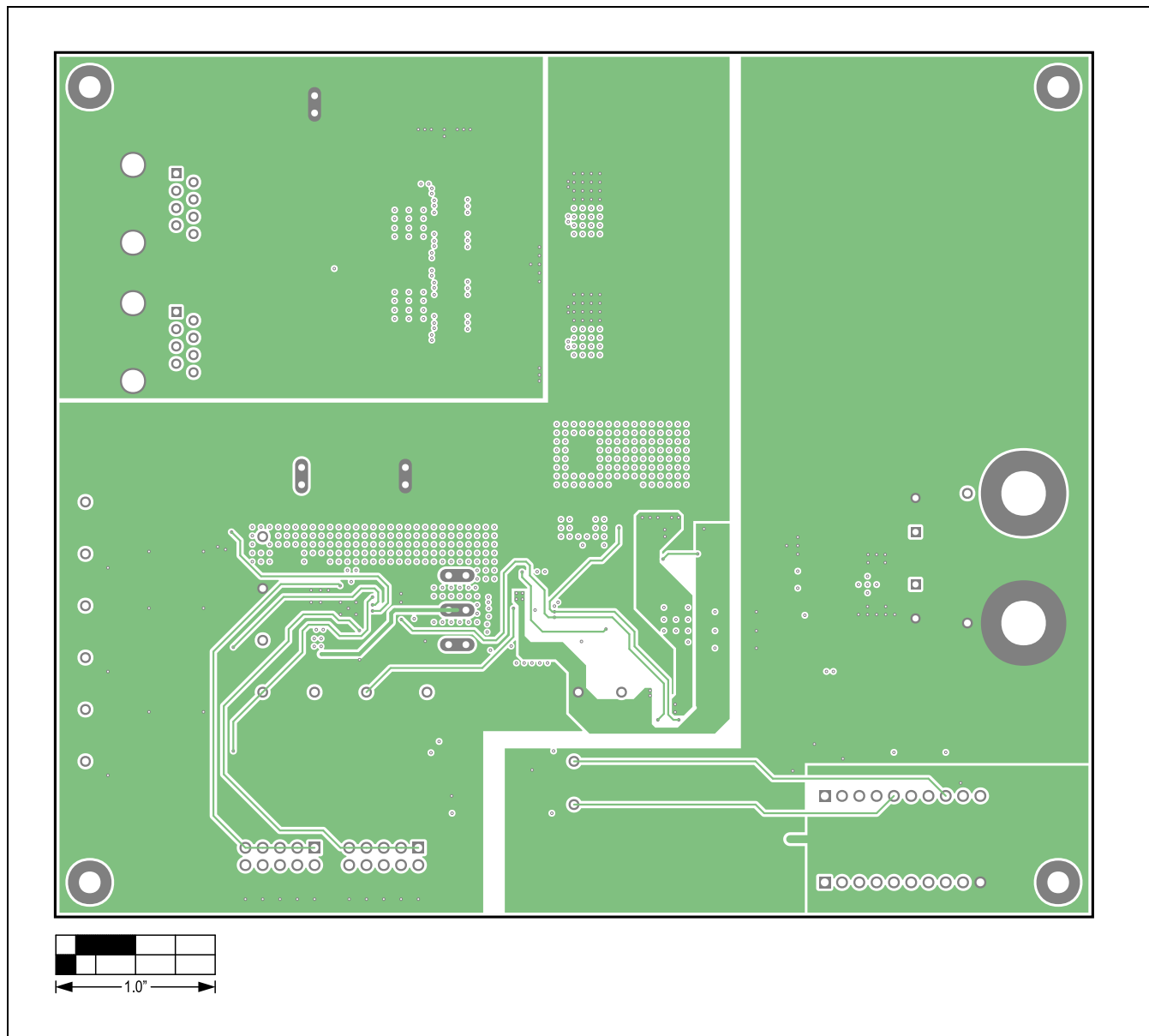

MAX5996A/MAX5996B/MAX5996C EV Kit PCB Layout—Layer 3

MAX5996A/MAX5996B/MAX5996C EV Kit PCB Layout Diagrams (continued)

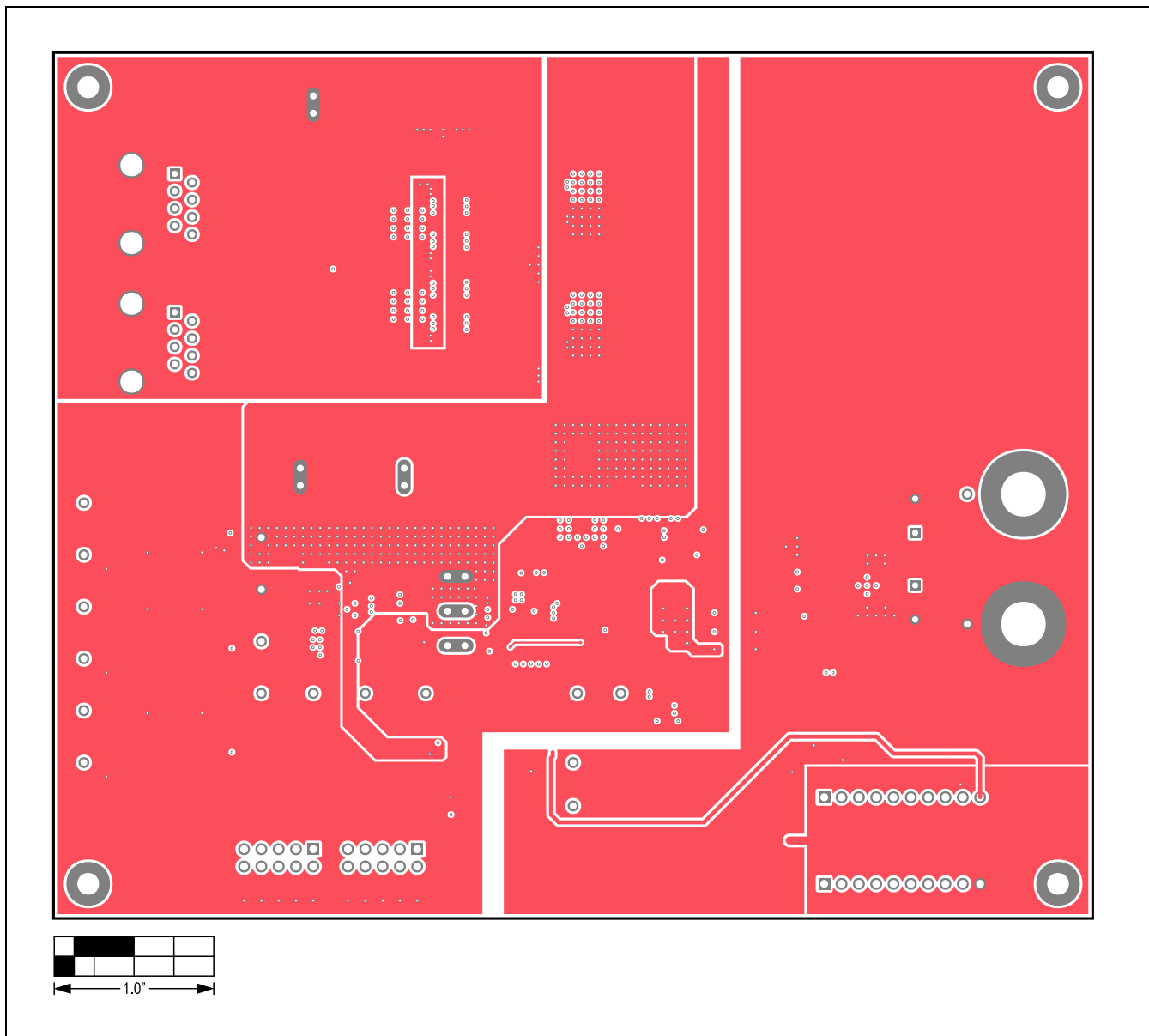

MAX5996A/MAX5996B/MAX5996C EV Kit PCB Layout—Layer 4

MAX5996A/MAX5996B/MAX5996C EV Kit PCB Layout Diagrams (continued)

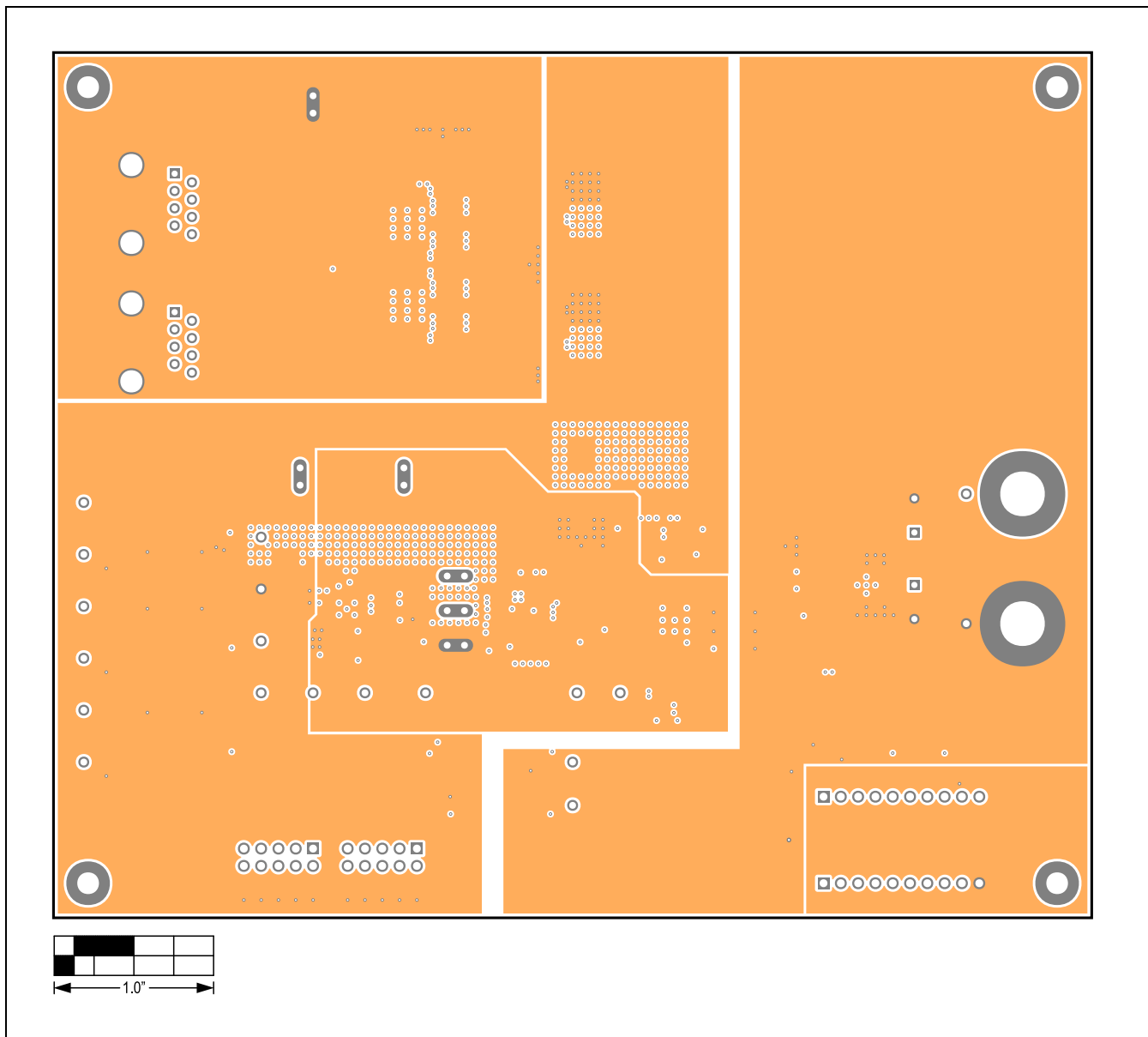

MAX5996A/MAX5996B/MAX5996C EV Kit PCB Layout—Layer 5

MAX5996A/MAX5996B/MAX5996C EV Kit PCB Layout Diagrams (continued)

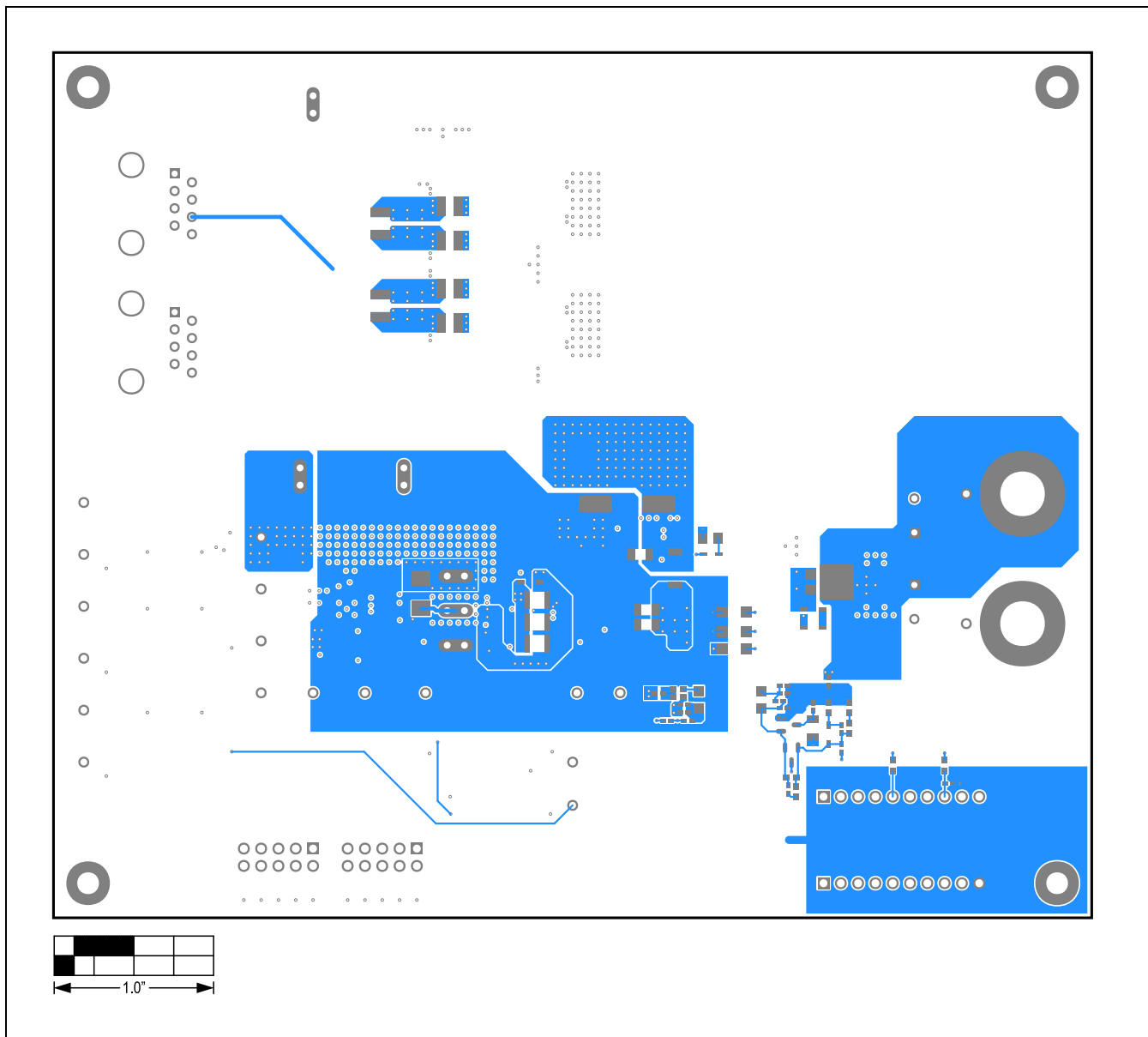

MAX5996A/MAX5996B/MAX5996C EV Kit PCB Layout—Bottom View

MAX5996A/MAX5996B/MAX5996C EV Kit PCB Layout Diagrams (continued)

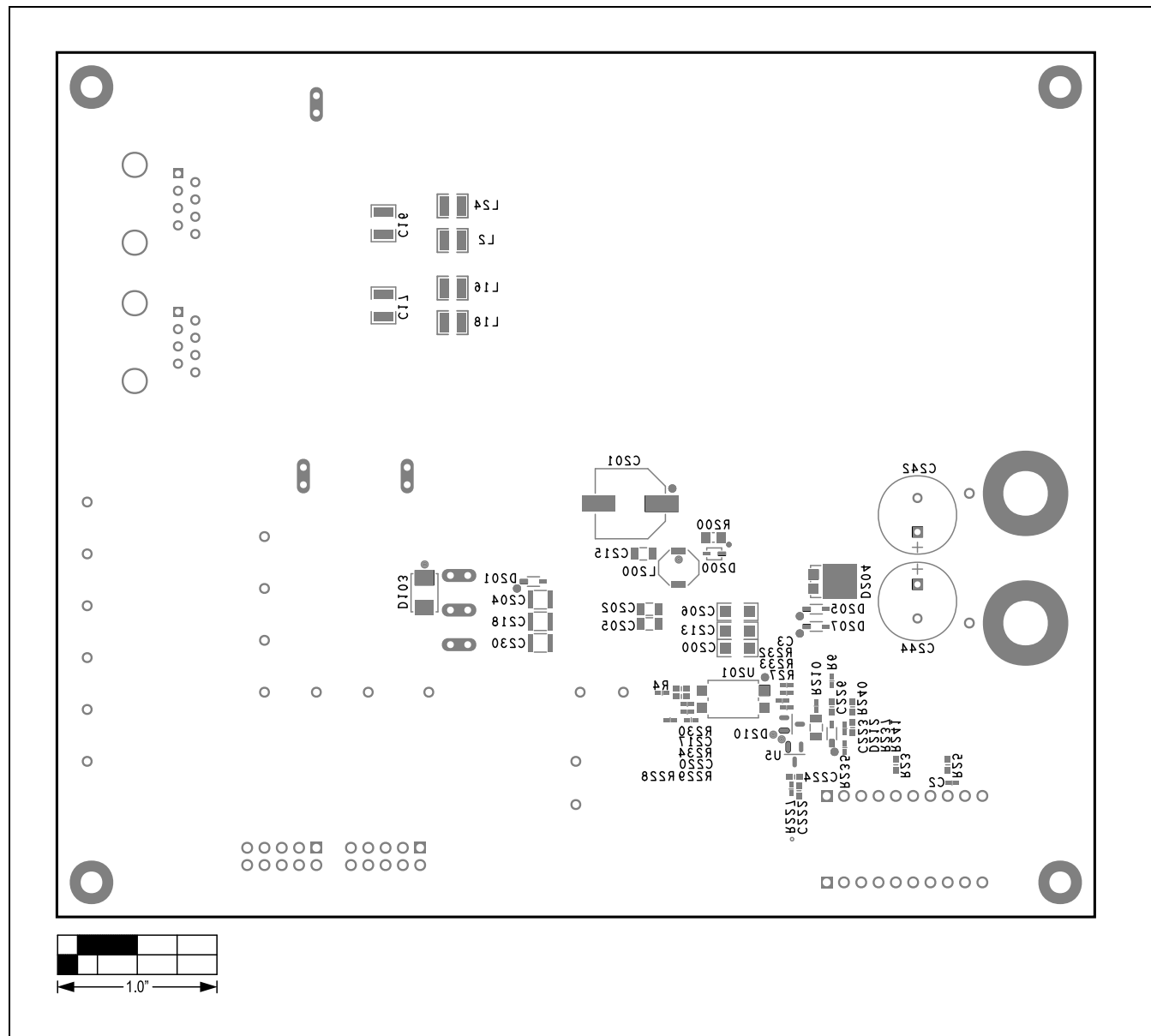

MAX5996A/MAX5996B/MAX5996C EV Kit PCB Layout—Bottom Silkscreen

MAX5996A/MAX5996B/
MAX5996C Evaluation Kit

Evaluates: MAX5996A/
MAX5996B/MAX5996C

Revision History

REVISION NUMBER	REVISION DATE	DESCRIPTION	PAGES CHANGED
0	09/21	Release for Market Intro	—

IEEE is a registered service mark of the Institute of Electrical and Electronics Engineers, Inc.

For pricing, delivery, and ordering information, please visit Maxim Integrated's online storefront at <https://www.maximintegrated.com/en/storefront/storefront.html>.

Maxim Integrated cannot assume responsibility for use of any circuitry other than circuitry entirely embodied in a Maxim Integrated product. No circuit patent licenses are implied. Maxim Integrated reserves the right to change the circuitry and specifications without notice at any time. The parametric values (min and max limits) shown in the Electrical Characteristics table are guaranteed. Other parametric values quoted in this data sheet are provided for guidance.