

U.I. Lapp GmbH	DATASHEET	
	EPIC® H-B 10 SGRLH	79036200 14.11.2013

Housing design H-B. The industry standard.
The smallest housing with single and double lever. The right housing is available for every application



Automation



Industrial machinery and plant engineering



Mechanical resistance



Robust



Waterproof

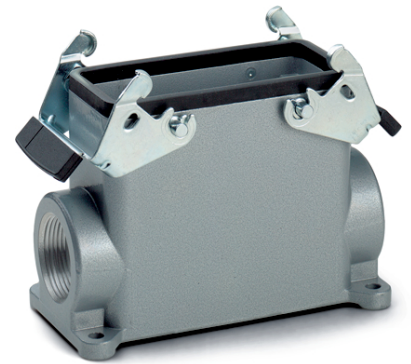

Info

Universal, robust metal housings size H-B 10

Application range

Plant engineering
Light & sound technology
Plastics industry

Product features

Surface-mount base, high version
Dual levers
2 cable entries

Remark

Photographs are not to scale and do not represent detailed images of the respective products.

Technical Data

Article:	H-B 10 SGRLH M25
M:	25
Pieces / PU:	10
Material:	Housing: powder-coated aluminium alloy, grey Lever: zinc-plated steel Sealing: NBR
Protection rating:	IP 65 (latched)
Temperature range:	-40 °C to +100 °C, short-term up to +125 °C

Product Management	Document: EPIC® H-B 10 SGRLH	1 / 2
--------------------	------------------------------	-------

U.I. Lapp GmbH	<h1>DATASHEET</h1>	 LAPP GROUP
	EPIC® H-B 10 SGR LH	79036200 14.11.2013

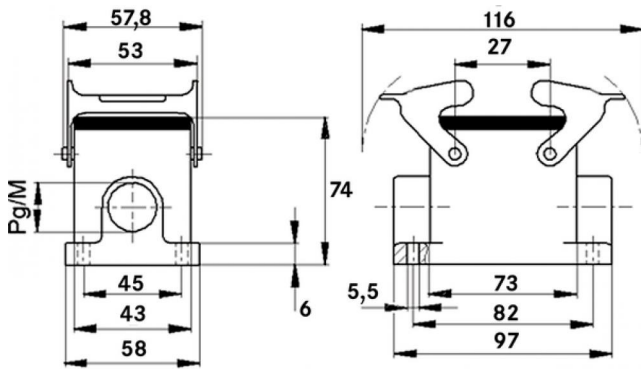

Product Management	Document: EPIC® H-B 10 SGR LH	2 / 2
--------------------	-------------------------------	-------