

TA2812

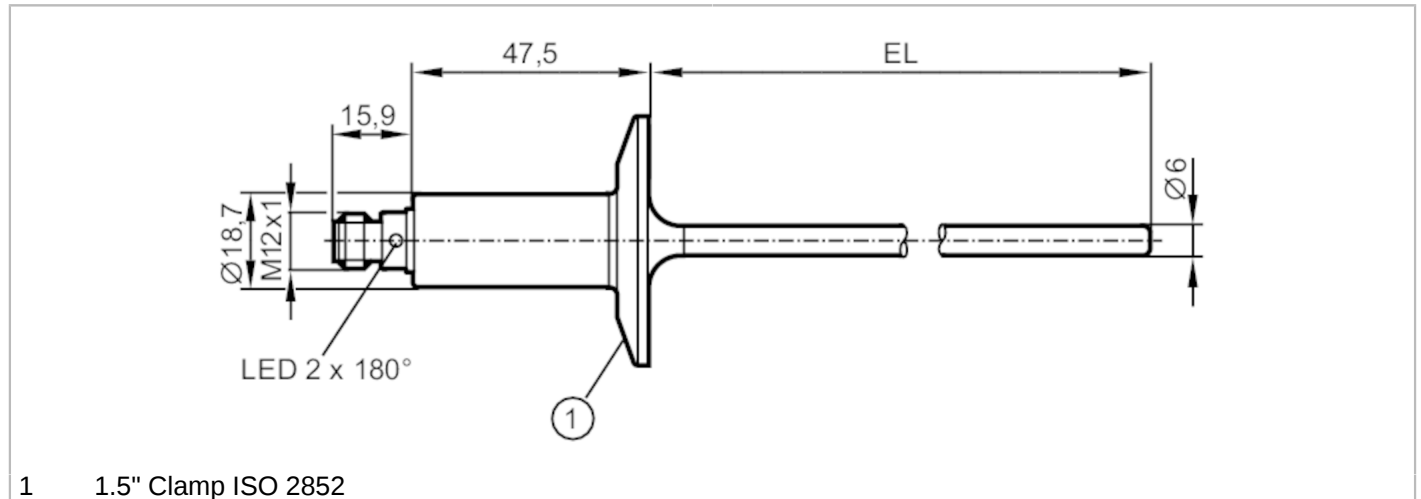

Temperature transmitter

TA-050CLEC01-- /US



1 1.5" Clamp ISO 2852



EC 1935/2004 EHEDG Certified FCM FDA IO-Link

Product characteristics

Number of inputs and outputs	Number of analogue outputs: 1
Measuring range [°C]	-50...200
Process connection	Clamp DN25...DN40 (1...1,5") DIN 32676 (ISO 2852)
Installation length EL [mm]	50

Application

Measuring element	1 x Pt 1000; (to DIN EN 60751, class A)
Media	liquids and gases
Pressure rating [bar]	100
Vacuum resistance [mbar]	-1000
MAWP (for applications according to CRN) [bar]	55

Electrical data

Operating voltage [V]	18...32 DC; ("supply class 2" to cULus)
Current consumption [mA]	< 50
Protection class	III
Reverse polarity protection	yes
Power-on delay time [s]	2

Inputs / outputs

Number of inputs and outputs	Number of analogue outputs: 1
------------------------------	-------------------------------

Outputs

Total number of outputs	1
Output signal	analogue signal; IO-Link; (configurable)
Number of analogue outputs	1
Analogue current output [mA]	4...20
Max. load [Ω]	250; ((18...19 V); 19...32 V: 300 Ω)
Short-circuit protection	yes
Overload protection	yes

TA2812



Temperature transmitter

TA-050CLEC01-- /US

Measuring/setting range		
Measuring range	[°C]	-50...200
Factory setting		0...200 °C
Resolution		
Resolution of analogue output	[K]	0.04
Accuracy / deviations		
Precision analogue output	[K]	± 0,3 + (± 0,1 % MS)
Temperature coefficient [% of the span / 10 K]		0,1; (in case of deviation from the reference condition 25 ± 5 °C)
Response times		
Dynamic response T05 / T09	[s]	< 0,5 / < 2
Interfaces		
Communication interface		IO-Link
Transmission type		COM2 (38,4 kBaud)
IO-Link revision		1.1
Operating conditions		
Ambient temperature	[°C]	-25...80
Note on ambient temperature		at medium temperature: < 160 °C
		-25...60 °C at medium temperature: < 200 °C
Storage temperature	[°C]	-40...100
Protection		IP 67; IP 68; IP 69K
Tests / approvals		
EMC		DIN EN 61000-6-2
		DIN EN 61000-6-3
Shock resistance		DIN IEC 68-2-27 50 g (11 ms)
Vibration resistance		DIN IEC 68-2-6 10 g (10...2000 Hz)
MTTF	[years]	232
Note on approval		factory certificate available as download at www.factory-certificate.ifm
UL approval		UL Approval no. K002
Mechanical data		
Weight	[g]	231.5
Dimensions	[mm]	Ø 18.71
Materials		stainless steel (1.4404 / 316L); PEI; FKM
Materials (wetted parts)		stainless steel (1.4404 / 316L) electropolished
Process connection		Clamp DN25...DN40 (1...1,5") DIN 32676 (ISO 2852)
Surface characteristics Ra/Rz of the wetted parts		Ra: < 0.8
Probe diameter	[mm]	6
Installation length EL	[mm]	50
Remarks		
Remarks		MS = set measuring span The values for accuracy apply to flowing water.
Pack quantity		1 pcs.

TA2812



Temperature transmitter

TA-050CLEC01-- /US

Electrical connection

Connector: 1 x M12



Connection

