



Part no.: 50135334
IPS 208i FIX-M3-102-I3-H
Smart camera



Ethernet

Figure can vary

Contents

- Technical data
- Dimensioned drawings
- Electrical connection
- Diagrams
- Operation and display
- Part number code
- Notes
- Accessories

Technical data

Basic data	
Series	IPS 200i
Application	Single compartment depth
Chip	CMOS
Special design	
Special design	Heating
Functions	
Software functions	Compartment fine positioning
Optical data	
Working range	100 ... 600 mm
Light source	LED , Infrared
Transmitted-signal shape	Pulsed
Camera resolution, horizontal	1,280 px
Camera resolution, vertical	960 px
Marker size (round)	5 ... 20 mm
Electronic shutter speed	0.068 ... 5 ms
Camera type	Monochrome
Measurement data	
Reproducibility (1 sigma)	0.1 mm , depending on the application
Electrical data	
Protective circuit	Polarity reversal protection Short circuit protected
Performance data	
Supply voltage U_B	18 ... 30 V , DC
Average power consumption	12 W
Inputs	
Number of digital switching inputs	3 Piece(s)
Switching inputs	
Type	Digital switching input
Voltage type	DC

Outputs

Number of digital switching outputs 5 Piece(s)

Switching outputs

Type Digital switching output

Voltage type DC

Switching current, max. 100 mA

Switching output 1

Switching principle +24 V switching

Switching output 2

Switching principle +24 V switching

Switching output 3

Switching principle +24 V switching

Switching output 4

Switching principle +24 V switching

Switching output 5

Switching principle +24 V switching

Interface

Type Ethernet

Ethernet

 Architecture Client
Server

 Address assignment DHCP
Manual address assignment

 Transmission speed 10 Mbit/s
100 Mbit/s

Function Process

Switch functionality None

Transmission protocol TCP/IP , UDP

Service interface

Type Ethernet

Ethernet

Function Service

Connection

Number of connections 2 Piece(s)

Connection 1

 Function Signal IN
Signal OUT
Voltage supply

Type of connection Connector

Thread size M12

Type Male

Material Metal

No. of pins 12 -pin

Encoding A-coded

Connection 2

Function	Configuration interface Data interface
Type of connection	Connector
Thread size	M12
Type	Female
Material	Metal
No. of pins	4 -pin
Encoding	D-coded

Mechanical data

Design	Cubic
Dimension (W x H x L)	43 mm x 61 mm x 44 mm
Housing material	Metal Plastic , Diecast aluminum , PC
Lens cover material	Plastic
Net weight	120 g
Housing color	Silver
Type of fastening	Mounting thread Via optional mounting device

Operation and display

Type of display	LED
Number of LEDs	9 Piece(s)
Type of configuration	Configuration codes Teach-in Via web browser
Operational controls	Button(s)
Function of the operational control	Adjustment mode Auto-setup

Environmental data

Ambient temperature, operation	-30 ... 50 °C
Ambient temperature, storage	-20 ... 70 °C
Relative humidity (non-condensing)	90 %

Certifications

Degree of protection	IP 65
Protection class	III
Certifications	c UL US
Test procedure for EMC in accordance with standard	EN 61000-6-2 EN 61000-6-4
Test procedure for continuous shock in accordance with standard	IEC 60068-2-29, test Eb
Test procedure for vibration in accordance with standard	IEC 60068-2-6, test Fc

Classification

Customs tariff number	84719000
eCl@ss 8.0	27310201
eCl@ss 9.0	27310201
ETIM 5.0	EC002550
ETIM 6.0	EC002550

Dimensioned drawings

All dimensions in millimeters

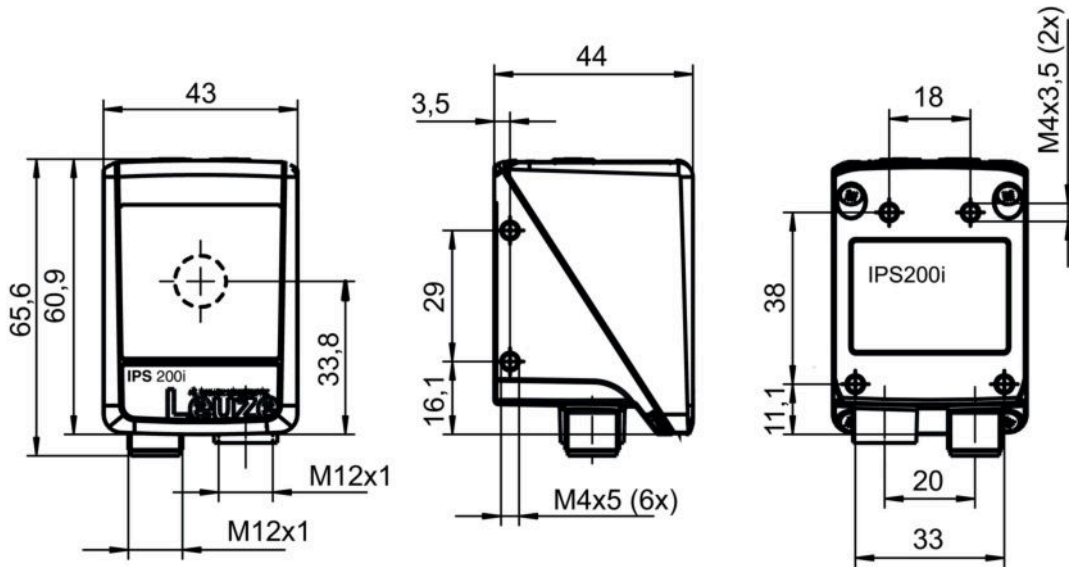

Electrical connection

Connection 1	PWR / SWI / SWO
Function	Signal IN Signal OUT Voltage supply
Type of connection	Connector
Thread size	M12
Type	Male
Material	Metal
No. of pins	12 -pin
Encoding	A-coded

Pin	Pin assignment
1	VIN
2	GND
3	SWIN 1
4	SWOUT 2
5	FE
6	n.c.
7	SWOUT 5
8	SWOUT 6
9	SWOUT 7
10	SWOUT 8
11	SWIO 3
12	SWIO 4

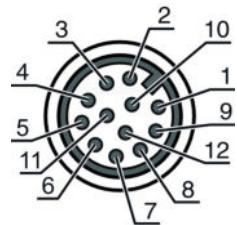

Connection 2	HOST
Function	Configuration interface Data interface

Connection 2	HOST
Type of connection	Connector
Thread size	M12
Type	Female
Material	Metal
No. of pins	4 -pin
Encoding	D-coded

Pin	Pin assignment
1	TD+
2	RD+
3	TD-
4	RD-

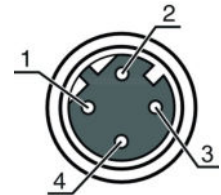

Diagrams

Typical working distances for markers with different marker diameters

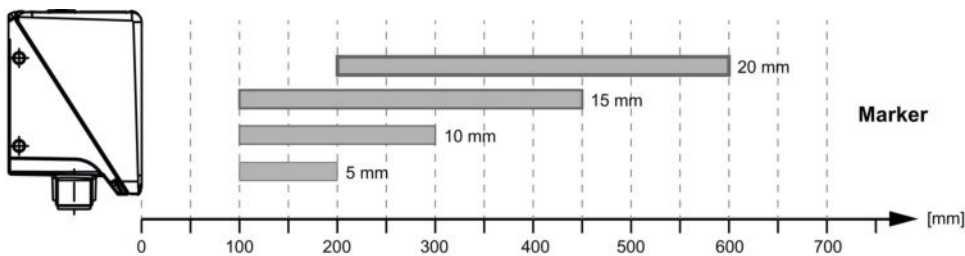

①

1 Distance [mm]

Mode of operation of the positioning sensor

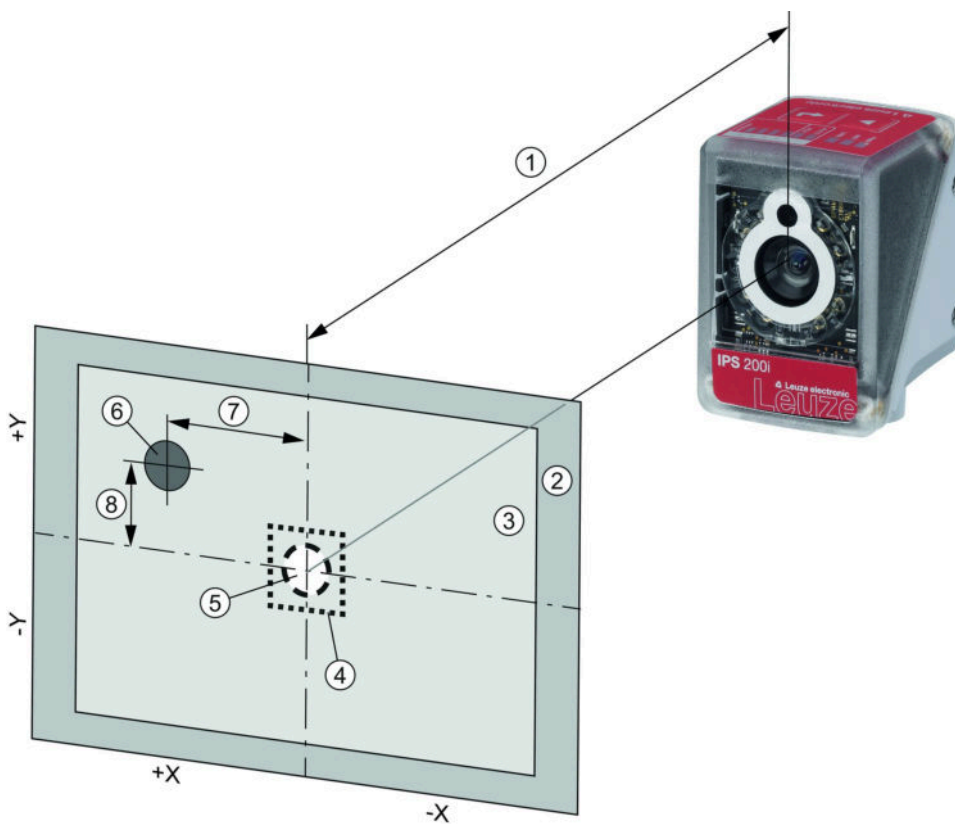

- 1 Working distance
- 2 Field of view (FOV)
- 3 Region of interest (ROI)
- 4 Tolerance range
- 5 Nominal position (marker)
- 6 Actual position (marker)
- 7 X deviation
- 8 Y deviation

Relationship between working distance and field of view size

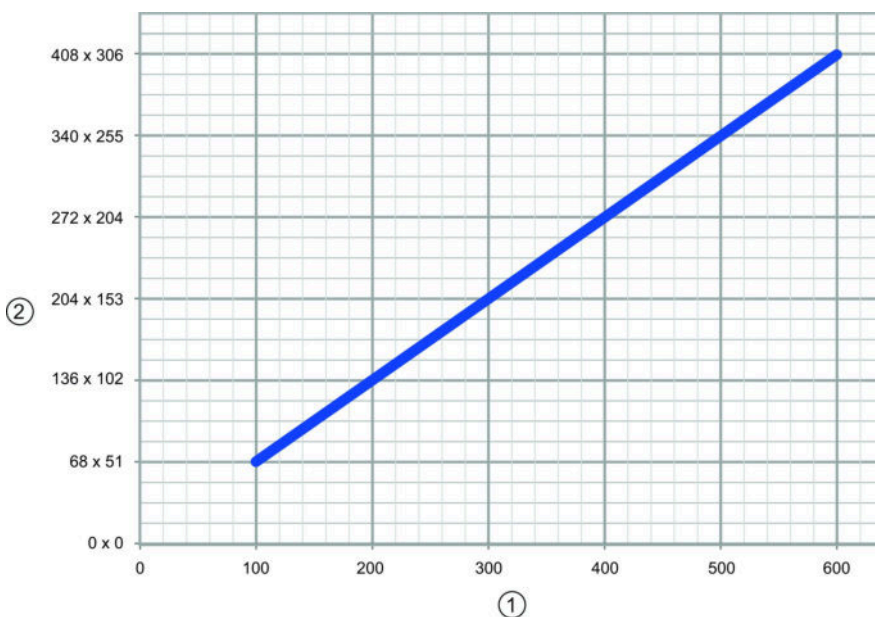

- 1 Distance [mm]
- 2 Field of view: width x height [mm]

Operation and display

LEDs

LED	Display	Meaning	
1	PWR	Off	No supply voltage
		Green, flashing	Initialization
		Green, continuous light	Operational readiness
		Orange, continuous light	Service operation
		Orange, flashing	Wave function
		Red, flashing	Device OK, warning set
		Red, continuous light	Device error
2	NET	Off	No supply voltage
		Green, flashing	Initialization
		Green, continuous light	Operational readiness
		Red, flashing	Communication error
		Red, continuous light	Network error
3	LINK	Green, continuous light	Ethernet connection is established
		Yellow, flashing	Data exchange active
4	AUTO	Green, flashing	Auto setup and teach-in of position
5	ADJ	Green, flashing	Alignment mode and teach-in of position
6	---	Green, flashing	Flashing frequency signals the marker distance to the nominal position
		Green, continuous light	Marker is in nominal position
7	---	Green, flashing	Flashing frequency signals the marker distance to the nominal position
		Green, continuous light	Marker is in nominal position
8	---	Green, flashing	Flashing frequency signals the marker distance to the nominal position
		Green, continuous light	Marker is in nominal position
9	---	Green, flashing	Flashing frequency signals the marker distance to the nominal position
		Green, continuous light	Marker is in nominal position

Part number code

Part designation: IPS AAAA BBB-DC-EEE-FG-H-J

IPS	Operating principle: Imaging Positioning Sensor (camera-based)
AAAA	Series/interface (integrated fieldbus technology): 208i: Ethernet TCP/IP 248i: PROFINET-IO, Ethernet TCP/IP, UDP
BBB	Equipment: FIX: Fixed focal length
C	Focus position: M: Medium Density (medium distance)
D	Lens: 3: 4.1 mm
EEE	Beam exit: 102: front
F	Illumination: I: infrared light
G	Resolution range: 3: 1280 x 960 pixels

Part no.: 50135334 – IPS 208i FIX-M3-102-I3-H – Smart camera

H	Protective screen: n/a: Plastic G: Glass
J	Special equipment: H: with heating

Note

A list with all available device types can be found on the Leuze electronic website at www.leuze.com.

Notes



Observe intended use!

- This product is not a safety sensor and is not intended as personnel protection.
- The product may only be put into operation by competent persons.
- Only use the product in accordance with its intended use.

- Warmup time: minimum 30 min at +24 VDC and an ambient temperature of -30 °C

Accessories

Connection technology - Connection cables

	Part no.	Designation	Article	Description
	50134943	KD S-M12-CW-P1-050	Connection cable	Connection 1: Connector, M12, Angled, Female, A-coded, 12 - pin Connection 2: Open end Shielded: Yes Cable length: 5,000 mm Sheathing material: PUR
	50135075	KS ET-M12-4A-P7-100	Connection cable	Suitable for interface: Ethernet Connection 1: Connector, M12, Axial, Male, D-coded, 4 -pin Connection 2: Open end Shielded: Yes Cable length: 10,000 mm Sheathing material: PUR

Connection technology - Interconnection cables

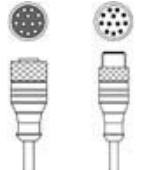
	Part no.	Designation	Article	Description
	50130286	KDS S-M12-CA-M12-CA-P1-100	Interconnection cable	Connection 1: Connector, M12, Axial, Female, A-coded, 12 -pin Connection 2: Connector, M12, Axial, Male, A-coded, 12 -pin Shielded: Yes Cable length: 10,000 mm Sheathing material: PUR

Part no.: 50135334 – IPS 208i FIX-M3-102-I3-H – Smart camera



Mounting technology - Mounting brackets

	Part no.	Designation	Article	Description
	50132151	BT 320M	Mounting bracket	Design of mounting device: Angle, L-shape Fastening, at system: Through-hole mounting Mounting bracket, at device: Screw type Type of mounting device: Rigid Material: Metal



Mounting technology - Rod mounts

	Part no.	Designation	Article	Description
	50132150	BTU 320M-D12	Mounting system	Contains: 4x M4 x 6 screws Design of mounting device: Mounting system Fastening, at system: For 12 mm rod Mounting bracket, at device: Screw type Type of mounting device: Clampable, Adjustable, Turning, 360° Material: Metal

Standard reflectors

	Part no.	Designation	Article	Description
	50130343	MTKZ 13-30 SET	Reflector	Contains: 100x Design: Round Reflection surface diameter: 15 mm Material: Plastic Base material: Plastic Chemical designation of the material: PA Fastening: Clip Suitable for bore hole diameter: 12.5 ... 13.5 mm Suitable for material thickness: 0.8 ... 5 mm Processing temperature: 5 ... 45 °C
	50129092	MTKZ 15-30 SET	Reflector	Contains: 100x Design: Round Reflection surface diameter: 15 mm Material: Plastic Base material: Plastic Chemical designation of the material: PA Fastening: Clip Suitable for bore hole diameter: 14.5 ... 15.5 mm Suitable for material thickness: 0.8 ... 5 mm Processing temperature: 5 ... 45 °C

Services

	Part no.	Designation	Article	Description
	S981014	CS30-S-110	Start-up support	Details: Performed at location of customer's choosing, duration: max. 10 hours. Conditions: Devices and connection cables are already mounted, price not including travel costs and, if applicable, accommodation expenses. Restrictions: No mechanical (mounting) and electrical (wiring) work performed, no changes (attachments, wiring, programming) to third-party components in the nearby environment.
	S981019	CS30-T-110	Product training	Details: Location and content to be agreed upon, duration: max. 10 hours. Conditions: Price not including travel costs and, if applicable, accommodation expenses. Restrictions: Travel costs and accommodation expenses charged separately and according to expenditure.

Part no.: 50135334 – IPS 208i FIX-M3-102-I3-H – Smart camera

Note

A list with all available accessories can be found on the Leuze electronic website in the Download tab of the article detailed page.