

Sample set - SAMPLE PTSM 0,5/ 2-2,5-H-SMD - 1701075

Please be informed that the data shown in this PDF Document is generated from our Online Catalog. Please find the complete data in the user's documentation. Our General Terms of Use for Downloads are valid (<http://phoenixcontact.com/download>)



PCB terminal block, Nominal current: 6 A, Nom. voltage: 160 V, Pitch: 2.5 mm, Number of positions: 2, Connection method: Push-in spring connection, Mounting: SMD soldering, Conductor/PCB connection direction: 0 °, Color: black

The illustration shows the 3-pos. version

Why buy this product

- ✓ Time saving push-in connection, tools not required
- ✓ Defined contact force ensures that contact remains stable over the long term
- ✓ High current carrying capacity of 6 A in very compact dimensions
- ✓ Designed for integration into the SMT soldering process
- ✓ Additional solder anchors reduce the mechanical strain on the soldering spots

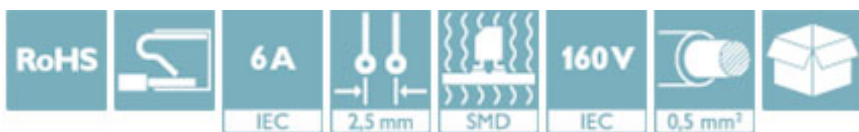

Key Commercial Data

Packing unit	5 STK
Minimum order quantity	5 STK
GTIN	 4 046356 515115
GTIN	4046356515115
Weight per Piece (excluding packing)	1.010 g
Custom tariff number	85369010
Country of origin	India

Technical data

Dimensions

Length	9 mm
Pitch	2.5 mm
Dimension a	2.5 mm
Height	5 mm
Length of the solder pin	2 mm
Pin spacing	2.5 mm

Sample set - SAMPLE PTSM 0,5/ 2-2,5-H-SMD - 1701075

Technical data

General

Range of articles	PTSM 0,5/..-H-SMD
Insulating material group	IIIa
Rated surge voltage (III/3)	2.5 kV
Rated surge voltage (III/2)	2.5 kV
Rated surge voltage (II/2)	2.5 kV
Rated voltage (III/3)	32 V
Rated voltage (III/2)	160 V
Rated voltage (II/2)	160 V
Connection in acc. with standard	EN-VDE
Nominal current I_N	6 A
Nominal cross section	0.5 mm ²
Maximum load current	6 A
Insulating material	LCP
Solder pin surface	Sn
Flammability rating according to UL 94	V0
Stripping length	6 mm
Number of positions	2

Connection data

Conductor cross section solid min.	0.14 mm ²
Conductor cross section solid max.	0.5 mm ²
Conductor cross section flexible min.	0.2 mm ²
Conductor cross section flexible max.	0.5 mm ²
Conductor cross section AWG min.	26
Conductor cross section AWG max.	20

Standards and Regulations

Connection in acc. with standard	EN-VDE
Flammability rating according to UL 94	V0

Environmental Product Compliance

China RoHS	Environmentally friendly use period: unlimited = EFUP-e
	No hazardous substances above threshold values

Drawings

Sample set - SAMPLE PTSM 0,5/ 2-2,5-H-SMD - 1701075

Drilling diagram

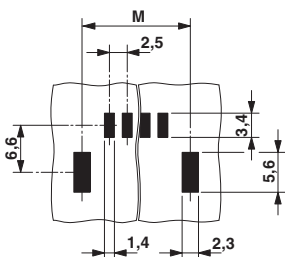

Diagram

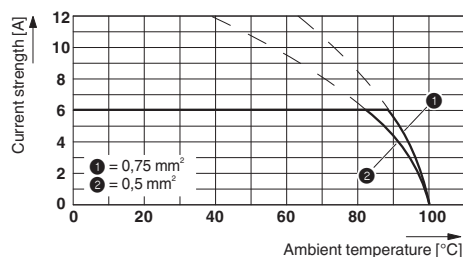

Dimensional drawing

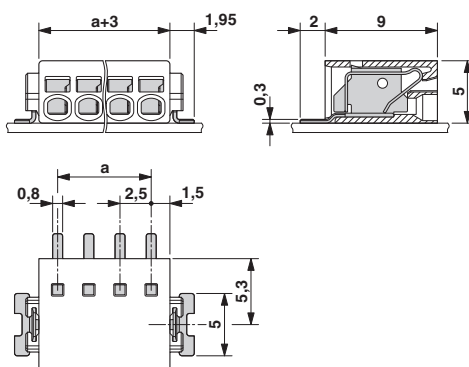

Classifications

eCl@ss

eCl@ss 4.0	27141111
eCl@ss 4.1	27141109
eCl@ss 5.0	27141190
eCl@ss 5.1	27141190
eCl@ss 6.0	27261101
eCl@ss 7.0	27440401
eCl@ss 8.0	27440401
eCl@ss 9.0	27440401

ETIM

ETIM 3.0	EC001121
ETIM 4.0	EC002643
ETIM 5.0	EC002637
ETIM 6.0	EC002637

UNSPSC

UNSPSC 6.01	30211801
UNSPSC 7.0901	39121432
UNSPSC 11	34131203
UNSPSC 12.01	39121432

Sample set - SAMPLE PTSM 0,5/ 2-2,5-H-SMD - 1701075

Classifications

UNSPSC

UNSPSC 13.2	39121432
-------------	----------

Approvals

Approvals

Approvals

EAC

Ex Approvals

Approval details

EAC		B.01742
-----	--	---------

Accessories

Accessories

Screwdriver tools

Screwdriver - SZS 0,4X2,0 - 1205202



Micro screwdriver, bladed, size: 0.4 x 2.0 x 60 mm, 2-component grip, with non-slip grip and twist cap

Additional products

PCB terminal block - PTSM 0,5/ 2-2,5-H SMD R24 - 1702473



PCB terminal block, Nominal current: 6 A, Nom. voltage: 160 V, Pitch: 2.5 mm, Number of positions: 2, Connection method: Push-in spring connection, Mounting: SMD soldering, Conductor/PCB connection direction: 0 °, Color: black