

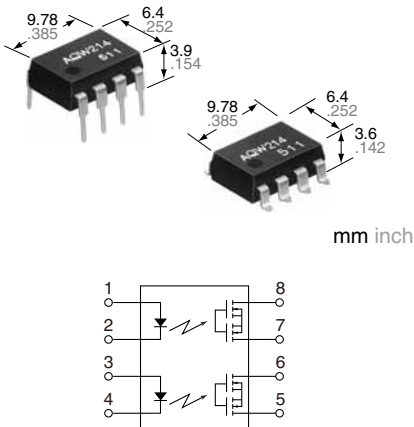

### Compact DIP8-pin type of 60V to 600V load voltage

### PhotoMOS<sup>®</sup> GU 2 Form A (AQW21○)



**RoHS compliant**

### FEATURES

- Compact 8-pin DIP size**  
The device comes in a compact (W) 6.4 × (L) 9.78 × (H) 3.9 mm (W) .252 × (L) .385 × (H) .154 inch, 8-pin DIP size (through hole terminal type).
- Applicable for 2 Form A use as well as two independent 1 Form A use**
- Controls low-level analog signals**  
PhotoMOS feature extremely low closed-circuit offset voltage to enable control of low-level analog signals without distortion.
- High sensitivity and high speed response**  
Can control max. 0.6 A load current with 5 mA input current. Fast operation speed of typ. 0.65 ms (AQW212).

- Low-level off state leakage current of max. 1 μA**
- Wide variation of load voltage 60V to 600V**

### TYPICAL APPLICATIONS

- High-speed inspection machines
- Telephones equipment
- Computer

### TYPES

	Output rating*		Package	Part No.				Packing quantity	
				Through hole terminal	Surface-mount terminal			Tube	Tape and reel
	Load voltage	Load current		Tube packing style		Tape and reel packing style			
AC/DC dual use	60V	500 mA	DIP8-pin	AQW212	AQW212A	AQW212AX	AQW212AZ	1 tube contains: 50 pcs. 1 batch contains: 500 pcs.	1,000 pcs.
	100 V	300 mA		AQW215	AQW215A	AQW215AX	AQW215AZ		
	200 V	160 mA		AQW217	AQW217A	AQW217AX	AQW217AZ		
	350 V	120 mA		AQW210	AQW210A	AQW210AX	AQW210AZ		
	400 V	100 mA		AQW214	AQW214A	AQW214AX	AQW214AZ		
	600 V	40 mA		AQW216	AQW216A	AQW216AX	AQW216AZ		

\*Indicate the peak AC and DC values.

Note: The surface mount terminal shape indicator "A" and the packing style indicator "X" or "Z" are not marked on the device.

### RATING

#### 1. Absolute maximum ratings (Ambient temperature: 25°C 77°F)

Item		Symbol	AQW212(A)	AQW215(A)	AQW217(A)	AQW210(A)	AQW214(A)	AQW216(A)	Remarks
Input	LED forward current	I <sub>F</sub>	50 mA						
	LED reverse voltage	V <sub>R</sub>	5 V						
	Peak forward current	I <sub>FP</sub>	1 A						f = 100 Hz, Duty factor = 0.1%
	Power dissipation	P <sub>in</sub>	75 mW						
Output	Load voltage (peak AC)	V <sub>L</sub>	60 V	100 V	200 V	350 V	400 V	600 V	
	Continuous load current	I <sub>L</sub>	0.50 A (0.60A)	0.30 A (0.35 A)	0.16 A (0.2 A)	0.12 A (0.14 A)	0.10 A (0.13 A)	0.04 A (0.05 A)	Peak AC, DC ( ): in case of using only 1 channel
	Peak load current	I <sub>peak</sub>	1.5 A	0.9 A	0.48 A	0.36 A	0.3 A	0.12 A	A connection: 100 ms (1 shot), V <sub>L</sub> = DC
	Power dissipation	P <sub>out</sub>	800 mW						
Total power dissipation		P <sub>T</sub>	850 mW						
I/O isolation voltage		V <sub>iso</sub>	1,500 V AC						Between input and output/between contact sets
Temperature limits	Operating	T <sub>opr</sub>	-40°C to +85°C -40°F to +185°F						Non-condensing at low temperatures
	Storage	T <sub>stg</sub>	-40°C to +100°C -40°F to +212°F						

# GU 2 Form A (AQW210)

## 2. Electrical characteristics (Ambient temperature: 25°C 77°F)

Item		Symbol	AQW212(A)	AQW215(A)	AQW217(A)	AQW210(A)	AQW214(A)	AQW216(A)	Condition
Input	LED operate current	Typical	0.9 mA						$I_L = \text{Max.}$
		Maximum	3 mA						
	LED turn off current	Minimum	0.4 mA						$I_L = \text{Max.}$
		Typical	0.8 mA						
LED dropout voltage	Typical	1.25 V (1.14 V at $I_F = 5 \text{ mA}$ )						$I_F = 50 \text{ mA}$	
	Maximum	1.5 V							
Output	On resistance	Typical	0.83 Ω	2.3 Ω	11 Ω	23 Ω	30 Ω	70 Ω	$I_F = 5 \text{ mA}$ $I_L = \text{Max.}$ Within 1 s on time
		Maximum	2.5 Ω	4.0 Ω	15 Ω	35 Ω	50 Ω	120 Ω	
	Off state leakage current	Maximum	1 μA						
Transfer characteristics	Turn on time*	Typical	0.65 ms	0.60 ms	0.25 ms	0.25 ms	0.31 ms	0.28 ms	$I_F = 5 \text{ mA}$ $I_L = \text{Max.}$
		Maximum	2 ms	2 ms	1.0 ms	0.5 ms	0.5 ms	0.5 ms	
	Turn off time*	Typical	0.08 ms	0.06 ms	0.05 ms	0.05 ms	0.05 ms	0.04 ms	$I_F = 5 \text{ mA}$ $I_L = \text{Max.}$
		Maximum	0.2 ms						
	I/O capacitance	Typical	0.8 pF						$f = 1 \text{ MHz}$ $V_S = 0 \text{ V}$
		Maximum	1.5 pF						
Initial I/C isolation resistance	Minimum	1,000 MΩ						500 V DC	

\*Turn on/Turn off time

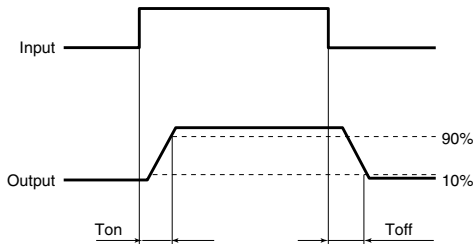

## RECOMMENDED OPERATING CONDITIONS

Please obey the following conditions to ensure proper device operation and resetting.

Item	Symbol	Recommended value	Unit
Input LED current	$I_F$	5	mA

■ These products are not designed for automotive use.

If you are considering to use these products for automotive applications, please contact your local Panasonic Corporation technical representative.

## REFERENCE DATA

1. Load current vs. ambient temperature characteristics

Allowable ambient temperature: -40°C to +85°C  
-40°F to +185°F

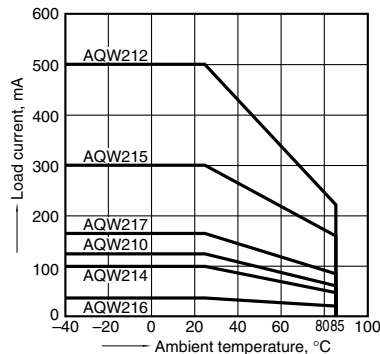

2.-(1) On resistance vs. ambient temperature characteristics

Measured portion: between terminals 5 and 6, 7 and 8;  
LED current: 5 mA; Load voltage: Max. (DC);  
Continuous load current: Max. (DC)

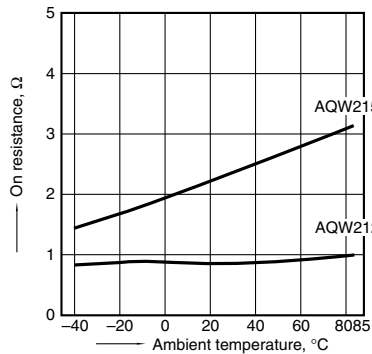

2.-(2) On resistance vs. ambient temperature characteristics

Measured portion: between terminals 5 and 6, 7 and 8;  
LED current: 5 mA; Load voltage: Max. (DC);  
Continuous load current: Max. (DC)

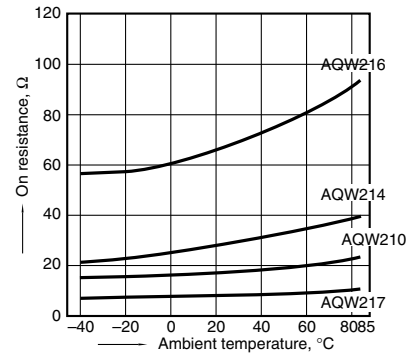

3. Turn on time vs. ambient temperature characteristics

LED current: 5 mA; Load voltage: Max. (DC); Continuous load current: Max. (DC)

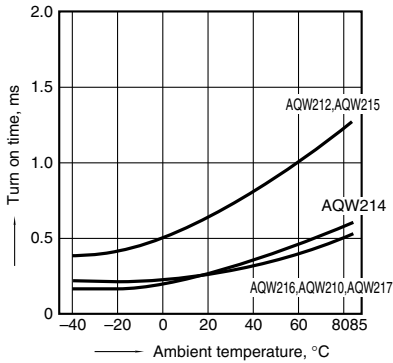

4. Turn off time vs. ambient temperature characteristics

LED current: 5 mA; Load voltage: Max. (DC); Continuous load current: Max. (DC)

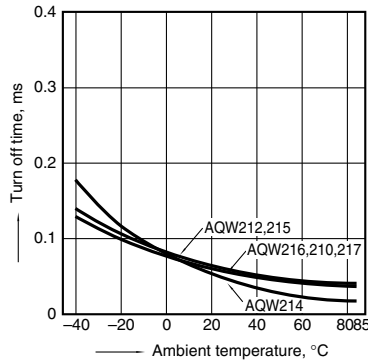

5. LED operate current vs. ambient temperature characteristics

Sample: All types; Load voltage: Max. (DC); Continuous load current: Max. (DC)

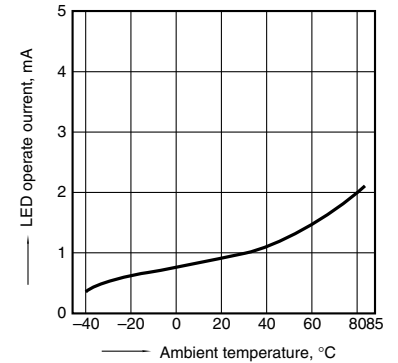

6. LED turn off current vs. ambient temperature characteristics

Sample: All types; Load voltage: Max. (DC); Continuous load current: Max. (DC)

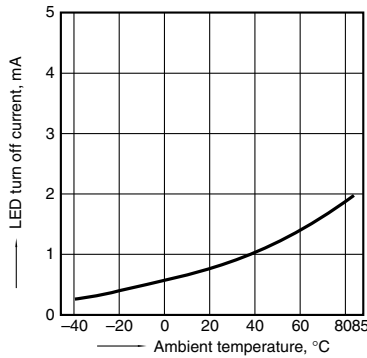

7. LED dropout voltage vs. ambient temperature characteristics

Sample: All types; LED current: 5 to 50 mA

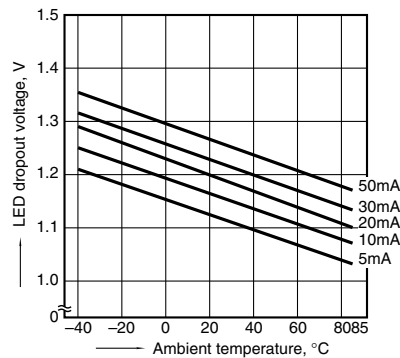

8.-(1) Current vs. voltage characteristics of output at MOS portion

Measured portion: between terminals 5 and 6, 7 and 8; Ambient temperature: 25°C 77°F

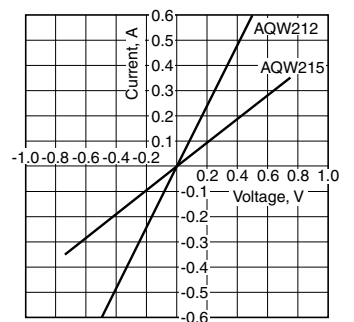

8.-(2) Current vs. voltage characteristics of output at MOS portion

Measured portion: between terminals 5 and 6, 7 and 8; Ambient temperature: 25°C 77°F

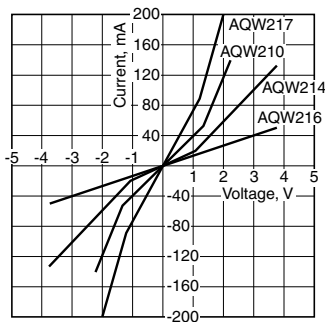

9.-(1) Off state leakage current vs. load voltage characteristics

Measured portion: between terminals 5 and 6, 7 and 8; Ambient temperature: 25°C 77°F

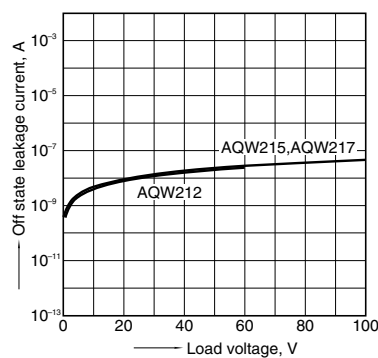

9.-(2) Off state leakage current vs. load voltage characteristics

Measured portion: between terminals 5 and 6, 7 and 8; Ambient temperature: 25°C 77°F

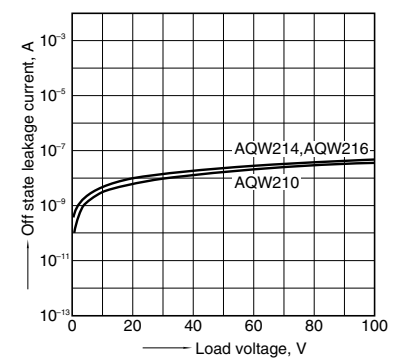

10. Turn on time vs. LED forward current characteristics

Measured portion: between terminals 5 and 6, 7 and 8; Load voltage: Max. (DC); Continuous load current: Max. (DC); Ambient temperature: 25°C 77°F

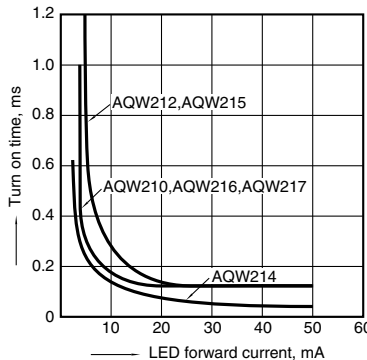

11. Turn off time vs. LED forward current characteristics

Measured portion: between terminals 5 and 6, 7 and 8; Load voltage: Max. (DC); Continuous load current: Max. (DC); Ambient temperature: 25°C 77°F

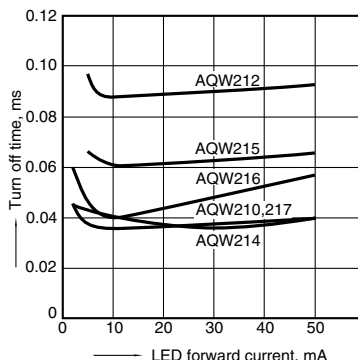

12. Output capacitance vs. applied voltage characteristics

Measured portion: between terminals 5 and 6, 7 and 8; Frequency: 1 MHz; Ambient temperature: 25°C 77°F

