

Battery Holder, CR1220



Applications

- Duracell, Eveready, Panasonic, Ray-O-Vac, Sanyo, Varta, Toshiba, Seiko and other major battery manufacturers
- Computer memory, power transfer and back-up systems
- Video and telecommunications power back-up
- Preprogrammed video and electronic games
- Microprocessors and microcomputer memory hold
- Notebook and laptop applications
- Emergency power systems
- Industrial and commercial security and alarm systems
- Communications power sources
- Miniaturized battery power devices



Specification

Output Voltage	3 V
Suitable Battery Model	1220 Coin Cell Battery

Material Specification

Base Material	Glass Filled PPS, UL94V-0
Contact Material	Phosphor Bronze
Contact Finish Material	Gold Flash over Nickel Plate

Drawing

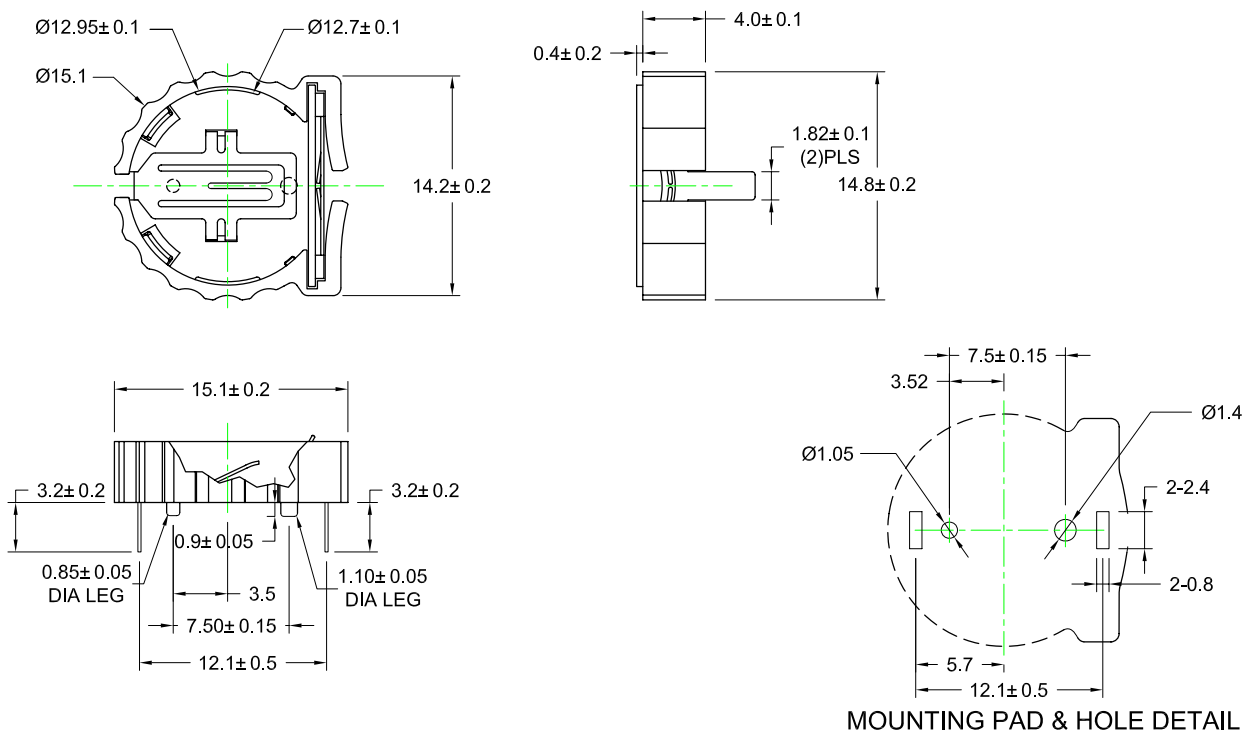

Art Nr.
RND 305-00031