





Potentiometer, Flat Front, without scale/inscription, R = 100 kOhm

Part no. M30C-FR100K-BLANK
Catalog No. 187044
Eaton Catalog No. M30C-FR100K-BLANK

Delivery program

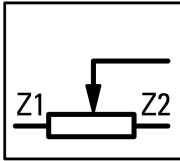
RMQ design			flat front
			
Part group reference (e.g. DIL)			M30
Mounting hole diameter		mm	30.5
Basic function			Potentiometer
Single unit/Complete unit			Single unit
Description			3 individual screw terminals Accuracy of resistance value: ± 10% (linear) Without scale/inscription
Contact sequence			
Impedance	R	kΩ	100
Rated power	P	W	0.5
Degree of Protection			IP66
Front ring			Metal bezel
Connection to SmartWire-DT			no

Technical data

General

Standards			IEC/EN 60947 VDE 0660
Lifespan, mechanical	Operations		25000
Climatic proofing			Damp heat, constant, to IEC 60068-2-78 Damp heat, cyclic, to IEC 60068-2-30
Degree of Protection			IP66
Ambient temperature			
Open		°C	-25 - +70
Mounting position			As required
Mechanical shock resistance		g	not planned
Terminal capacities		mm ²	
Solid		mm ²	0.5 - 1.5
Stranded		mm ²	0.5 - 1.5
Tightening torque for terminal screw		Nm	0.5

Contacts

Rated impulse withstand voltage	U _{imp}	V AC	4000
Rated insulation voltage	U _i	V	250
Overvoltage category/pollution degree			III/3

Design verification as per IEC/EN 61439

Technical data for design verification			
Operating ambient temperature max.		°C	-25
Operating ambient temperature max.		°C	70

Technical data ETIM 6.0

Resistance	Ohm	100000
Power consumption	W	0.5
Hole diameter	mm	30
Degree of protection (IP)		IP66

Dimensions

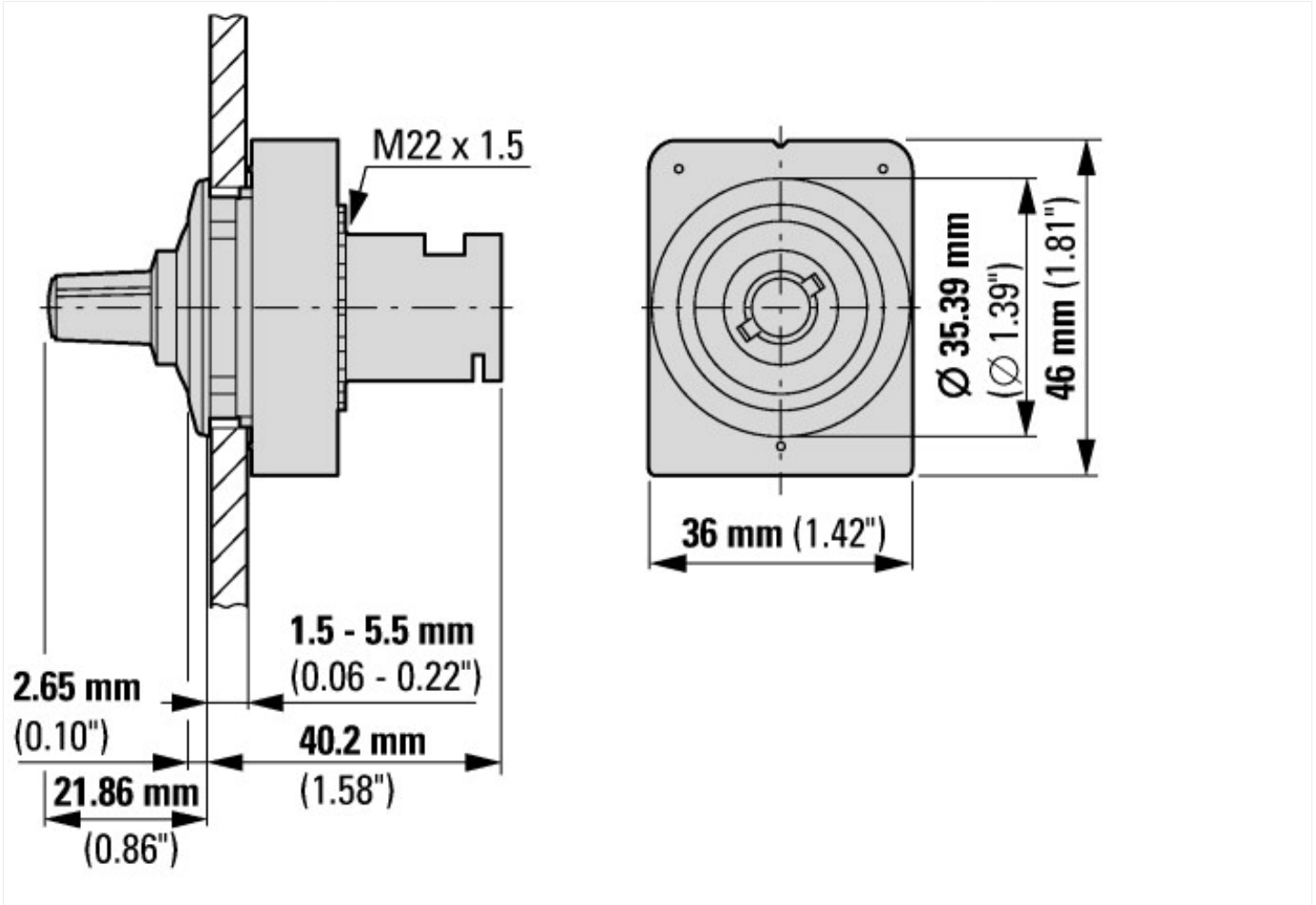



with 2 M22-K... standard contact elements



with M22-FK... flat rear contact elements



Additional product information (links)

IL047019ZU Flat Front

IL047019ZU Flat Front

ftp://ftp.moeller.net/DOCUMENTATION/AWA_INSTRUCTIONS/IL047019ZU2017_02.pdf