

EBC136

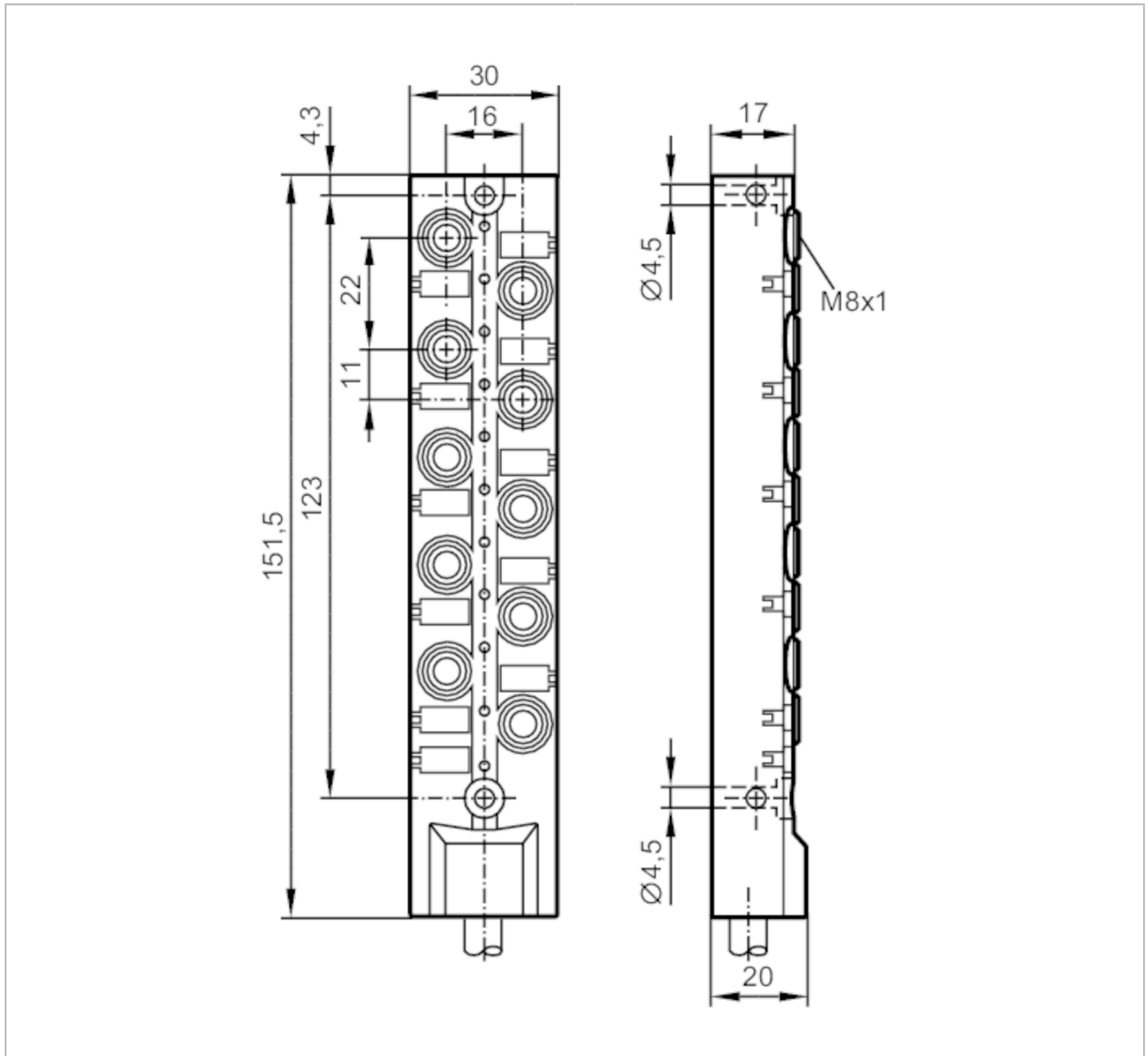

Splitter box

ZDOAF03BMSS0005H12



Application	
Special feature	Halogen-free; Gold-plated contacts; Drag chain suitability
Electrical data	
Operating voltage	[V] 10...30 DC; ("supply class 2" to cULus)
Protection class	III
Max. current load per module/slot	[A] 2
Max. current load total	[A] 6
Outputs	
Electrical design	PNP

EBC136



Splitter box

ZDOAF03BMSS0005H12

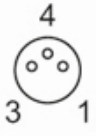
Operating conditions		
Ambient temperature	[°C]	-25...80
Ambient temperature (moving)	[°C]	-5...60
Protection		IP 65; IP 67; IP 68
Mechanical data		
Weight	[g]	565.7
Materials		PBT-GF20; brass nickel-plated
Number of ports splitter box		10
Connector type		M8
Drag chain suitability		yes
Drag chain suitability	bending radius for flexible use	min. 10 x cable diameter
	travel speed	max. 3.3 m/s for a horizontal travel length of 5 m and max. acceleration of 5 m/s ²
	bending cycles	> 5 Mio.
	torsional strain	± 180 °/m
Displays / operating elements		
Display	switching status	10 x LED, yellow
	operation	1 x LED, green
Accessories		
Accessories (optional)		Protective caps, for M8 sockets, E73005
Remarks		
Pack quantity		1 pcs.
Electrical connection		
Cable: 5 m, PUR, Halogen-free, black, Ø 9.1 mm; 10 x 0.34 mm ² (43 x Ø 0.1 mm) + 2 x 0.75 mm ² (21 x Ø 0.2 mm)		
Electrical connection - socket		
Connector: 1 x M8; Moulded body: PBT-GF 20 / brass, nickel-plated; Contacts: gold-plated		
		



Splitter box

ZDOAF03BMSS0005H12

Connection

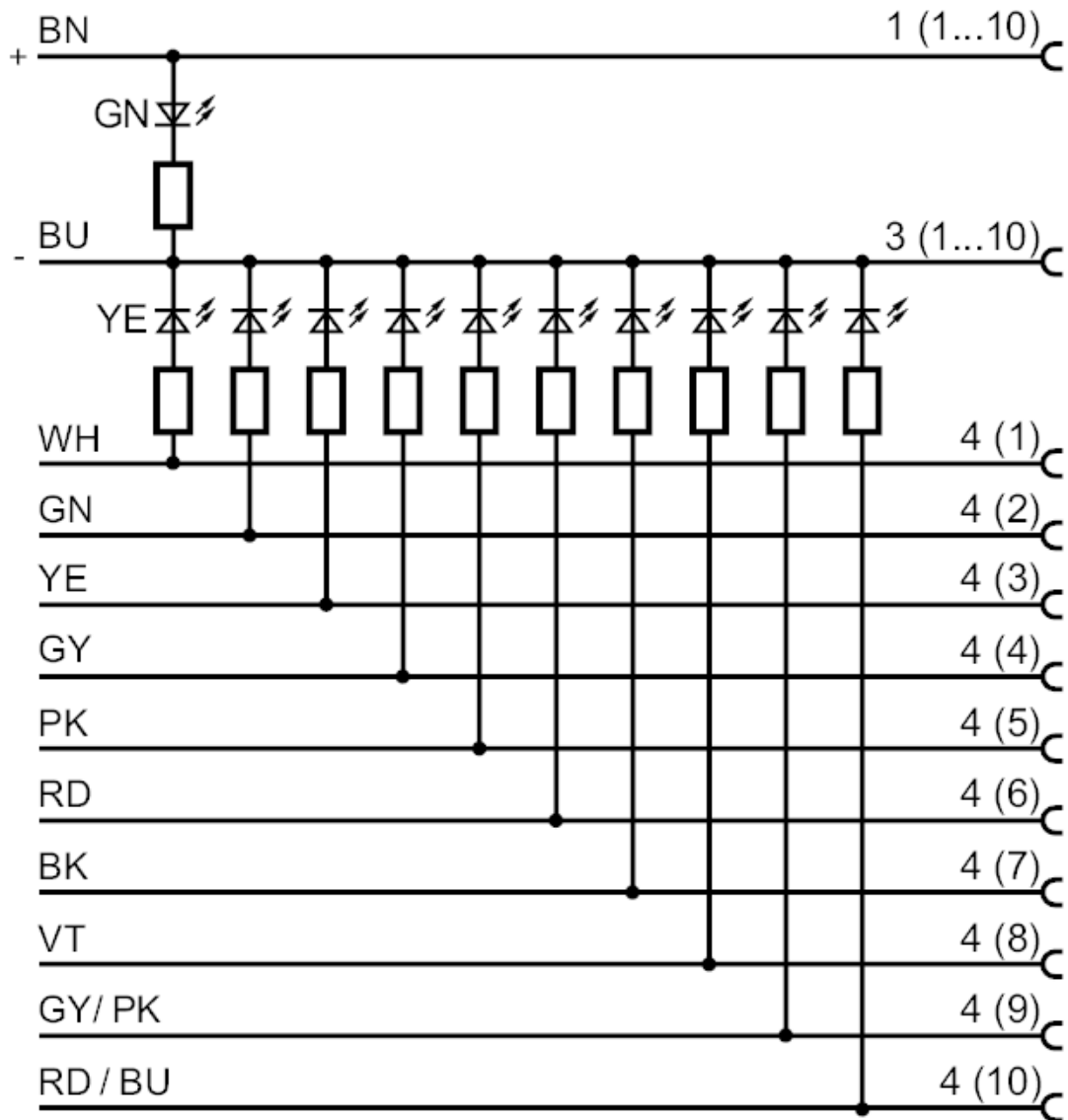

Core colours :

BK =	black
BN =	brown
BU =	blue
GN =	green
GY =	grey
PK =	pink
RD =	red
VT =	lilac
WH =	white
YE =	yellow

EBC136

Splitter box

ZDOAF03BMSS0005H12

