

3-phase + neutral line filters FN 256

Compact general purpose 3-phase + neutral EMC filter

SCHAFFNER
safety for electronic systems



- Three-phase + neutral line filter for general purpose four-wire filtering
- Compact space-saving design
- Choice of connection style
- Low operating leakage current

Approvals



RoHS
2002/95/EC

By December 2005

Technical specifications

Maximum continuous operating voltage:	3x 480VAC (FN 256) 3x 520VAC (FN 256 -H)
Operating frequency:	dc to 60Hz
Rated currents:	8 to 160A @ 50°C
High potential test voltage:	P → E 2650VDC for 2 sec (FN 256) P → P 2100VDC for 2 sec (FN 256) P → E 3000VDC for 2 sec (FN 256 -H) P → P 2250VDC for 2 sec (FN 256 -H)
Protection category:	IP20 IP00 (filters with connectors -28)
Overload capability:	4x rated current at switch on, 1.5x rated current for 1 minute, once per hour
Temperature range (operation and storage):	-25°C to +100°C (25/100/21)
Flammability corresponding to:	UL94V-2 or better
Design corresponding to:	UL1283, CSA22.2 No. 8 1986, EN133'200
MTBF @ 50°C/400V (Mil-HB-217F):	600,000 hours

Features and benefits

- FN 256 filters are designed specifically for applications involving asymmetric loads, ranging from industrial controls to medical electronics systems. These typically involve insufficiently filtered converters and switch-mode power supplies on different phases, causing current imbalance and significant interference problems.
- Employing single-stage filter circuits for each phase and the neutral line, FN 256 filters provide high attenuation of both symmetrical and asymmetrical interference.
- Used as a mains input filter, FN 256 filters also increase conducted immunity and thus contribute to overall system reliability.
- Choice of connection style as well as filter ratings in line with common fuse values support a fast and easy application-specific filter selection and deployment.
- A lightweight aluminium housing with a small footprint ensures that the filters can be easily accommodated on control panels and in tight power cabinets.

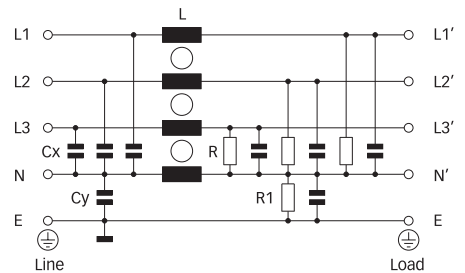

Typical electrical schematic



Typical applications

- General purpose 4-wire filtering
- High power office equipment
- Power supplies
- UPS
- Medical applications
- Electrical cabinets
- Control panels

Filter selection table

Filter*	Rated current	Leakage current**	Power loss	Input/Output connections		Weight
	@ 50°C (40°C)	@ 400VAC/50Hz	@ 25°C/50Hz			
	[A]	[mA]	[W]			
FN 256-8-46	8 (8.8)	3.4	2.7	-46		0.8
FN 256-16-46	16 (17.5)	3.4	6.0	-46		1.1
FN 256-25-47	25 (27)	3.4	11.6	-47		1.4
FN 256-36-47	36 (39)	3.4	14.8	-47		1.5
FN 256-64-52	64 (70)	3.4	18.4	-52		2.2
FN 256-80-...	80 (88)	3.4	18.8		-28***	4.5
FN 256-120-...	120 (131)	5.0	25.1		-28***	6.1
FN 256-160-...	160 (175)	6.8	30.7		-28***	8.0
FN 256-8-46-H	8 (8.8)	3.6	2.7	-46		0.8
FN 256-16-46-H	16 (17.5)	3.6	6.0	-46		1.1
FN 256-25-47-H	25 (27)	3.6	11.6	-47		1.4
FN 256-36-47-H	36 (39)	3.6	14.8	-47		1.5
FN 256-64-52-H	64 (70)	3.6	18.4	-52		2.2
FN 256-80-...-H	80 (88)	3.6	18.8		-28***	4.5
FN 256-120-...-H	120 (131)	5.4	25.1		-28***	6.1
FN 256-160-...-H	160 (175)	7.4	30.7		-28***	8.0

* To compile a complete part number, please replace the -.. with the required I/O connection style.

** Maximum leakage under normal operating conditions, based on the assumption, that all 3 phases and the neutral conductor are connected to the supply and the consumer. In this case, the current will mainly return through the neutral line, not as earth leakage.

*** Filters with -28 connections are rated for 40°C environmental temperature only.

Typical filter attenuation

Per CISPR 17; A = 50Ω/50Ω sym, B = 50Ω/50Ω asym, C = 0.1Ω/100Ω sym, D = 100Ω/0.1Ω sym

8A types

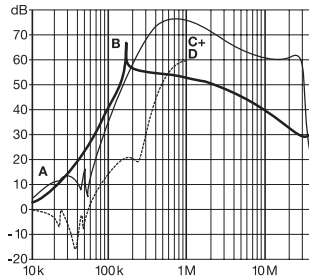

16A types

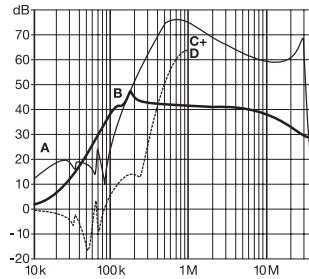

25A types

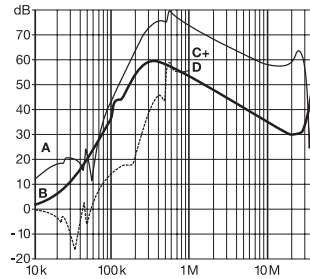

36A types

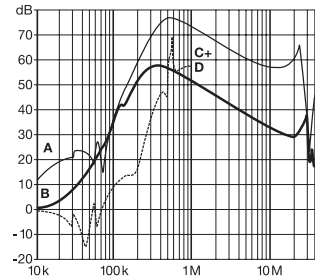

64A types

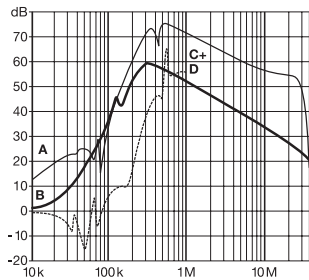

80A types

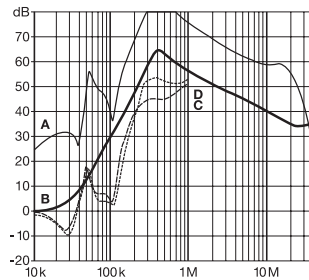

120A types

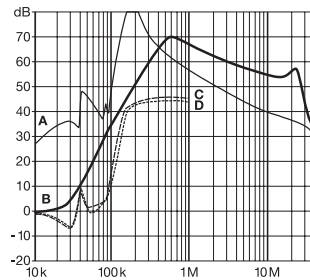

160A types

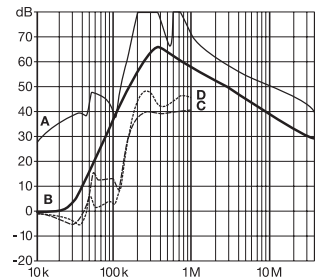

Mechanical data

8 to 64A types

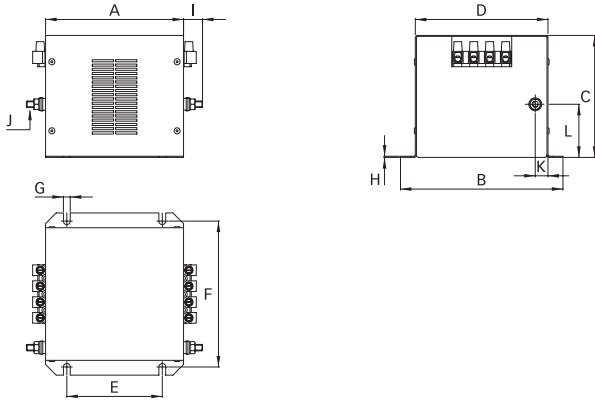

80 to 160A types (-28)

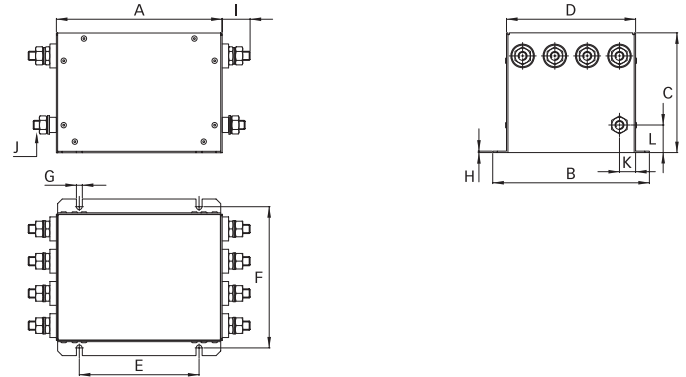

80 to 160A types (-34, -35, -40)

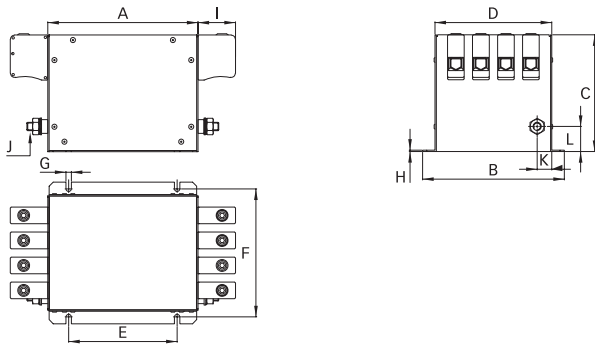

Dimensions

	8A	16A	25A	36A	64A	80A (-28)	80A (-34)	120A (-28)	120A (-35)	160A (-28)	160A (-40)
A	120	120	130	130	140	160	160	180	180	200	200
B	143	143	153	153	153	170	170	170	170	170	170
C	80	80	115	115	125	110	110	130	140	130	160
D	115	115	125	125	125	140	140	140	140	140	140
E	80	80	90	90	100	110	110	130	130	150	150
F	127.5	127.5	137.5	137.5	137.5	153.5	153.5	153.5	153.5	153.5	153.5
G	6.5	6.5	6.5	6.5	6.5	6.5	6.5	6.5	6.5	6.5	6.5
H	1	1	1	1	1.5	1.5	1.5	1.5	1.5	1.5	1.5
I	18	18	18	18	18	30	39	30	45	30	49.5
J	M6	M6	M6	M6	M6	M10	M10	M10	M10	M10	M10
K	12	12	13	13	13	17.5	17.5	17.5	17.5	17.5	17.5
L	33	33	50	50	50	30	30	30	30	30	30

All dimensions in mm; 1 inch = 25.4mm

Tolerances according: ISO2768 / EN22768

Filter input/output connector cross sections

	-28 (M10)	-34	-35	-40	-46	-47	-52
Solid wire	n/a	35mm ²	50mm ²	95mm ²	10mm ²	16mm ²	25mm ²
Flex wire	n/a	25mm ²	50mm ²	95mm ²	6mm ²	10mm ²	16mm ²
AWG type wire	n/a	AWG 2	AWG 1/0	AWG 4/0	AWG 10	AWG 8	AWG 4
Recommended torque	17 - 18Nm	4.0 - 4.5Nm	7 - 8Nm	17 - 20Nm	0.7 - 0.8Nm	1.9 - 2.2Nm	1.9 - 2.2Nm

Please visit www.schaffner.com to find more details on filter connectors.