

mm inch

## FEATURES

- **High sensitivity:**  
2 Form C: 140 mW power consumption (single side stable type)  
4 Form C: 280 mW power consumption (single side stable type)
- **Surge voltage withstand: 1500 V FCC Part 68**
- **Sealed construction allows automatic washing**
- **Self-clinching terminal also available**
- **M.B.B. contact types available**

## SPECIFICATIONS

### Contact

		Standard (B.B.M) type		M.B.B.type
		2 Form C	4 Form C	2 Form D
Arrangement		2 Form C	4 Form C	2 Form D
Initial contact resistance, max. (By voltage drop 6 V DC 1A)		50 mΩ		
Contact material		Gold-clad silver		
Rating	Nominal switching capacity (resistive load)	1 A 30 V DC 0.5 A 125 V AC		1 A 30 V DC
	Max. switching power (resistive load)	30 W, 62.5 V A		30 W
	Max. switching voltage	110 V DC, 125 V AC		110 V DC
	Max. switching current	1 A		
	Min. switching capacity (Reference value) <sup>#1</sup>	10 μA 10 mV DC		
Nominal operating power	Single side stable	140 mW (3 to 12 V DC) 200 mW (24 V DC) 300 mW (48 V DC)	280 mW (3 to 24 V DC) 400 mW (48 V DC)	200 mW
	1 coil latching	100 mW (3 to 12 V DC) 150 mW (24 V DC)	200 mW	—
	2 coil latching	200 mW (3 to 12 V DC) 300 mW (24 V DC)	400 mW	—
Expected life (min. operations)	Mechanical (at 180 cpm)	10 <sup>8</sup>		10 <sup>7</sup>
	Electrical (at 20 cpm) (1 A 30 V DC resistive) (0.5 A 125 V AC resistive)	2 × 10 <sup>5</sup>	10 <sup>5</sup>	—

### Note:

#1 This value can change due to the switching frequency, environmental conditions, and desired reliability level, therefore it is recommended to check this with the actual load. (SX relays are available for low level load switching [10V DC, 10mA max. level])

### Remarks

- \* Specifications will vary with foreign standards certification ratings.
- \*1 Measurement at same location as "Initial breakdown voltage" section.
- \*2 By resistive method, nominal voltage applied to the coil; contact carrying current: 1 A.
- \*3 Nominal voltage applied to the coil, excluding contact bounce time.
- \*4 Nominal voltage applied to the coil, excluding contact bounce time without diode.
- \*5 Half-wave pulse of sine wave: 11 ms; detection time: 10 μs.
- \*6 Half-wave pulse of sine wave: 6 ms.
- \*7 Detection time: 10 μs.

### Characteristics

		Standard (B.B.M) type	M.B.B.type
		Initial insulation resistance*1	
Initial breakdown voltage	Between open contacts	750 Vrms for 1 min. (Detection current: 10 mA)	300 Vrms for 1 min. (Detection current: 10 mA)
	Between contact and coil	1,000 Vrms for 1 min. (Detection current: 10 mA)	
	Between contact sets	1,000 Vrms for 1 min. (Detection current: 10 mA)	
FCC surge voltage between open contacts		1,500 V	
Operate time [Set time] <sup>*3</sup> (at 20°C)		Max. 3 ms [Max. 3 ms]	
Release time [Reset time] <sup>*4</sup> (at 20°C)		Max. 3 ms [Max. 3 ms]	
M.B.B. time*8		—	Min. 10 μs.
Temperature rise*2 (at 20°C)		Max. 50°C	
Shock resistance	Functional*5	Min. 490 m/s <sup>2</sup> {50G}	
	Destructive*6	Min. 980 m/s <sup>2</sup> {100G}	
Vibration resistance	Functional*7	176.4 m/s <sup>2</sup> {18G}, 10 to 55 Hz at double amplitude of 3 mm	
	Destructive	294 m/s <sup>2</sup> {30G}, 10 to 55 Hz at double amplitude of 5 mm	
Conditions for operation, transport and storage*9 (Not freezing and condensing at low temperature)	Ambient temperature	-40°C to +70°C -40°F to +158°F	-40°C to +50°C -40°F to +122°F
	Humidity	5 to 85% R.H.	
Unit weight	2 Form C:	Approx. 1.5 g .053 oz	
	4 Form C:	Approx. 3 g .106 oz.	—

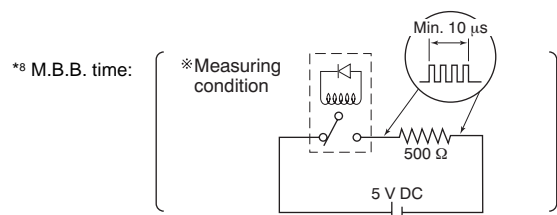

\*9 Refer to 6. Conditions for operation, transport and storage mentioned in [AMBIENT ENVIRONMENT](#) (p. 19, Relay Technical Information).

## ORDERING INFORMATION

EX. TQ 2 H — L2 — 2M — 3V

Contact arrangement	Terminal shape	Operating function	MBB function	Coil voltage (DC)
2: 2 Form C 4: 4 Form C	Nil: Standard PC board terminal H: Self-clinching terminal	Nil: Single side stable L: 1 coil latching L2: 2 coil latching	Nil: Standard (B.B.M.) type 2M: 2M.B.B. type	3, 4.5, 5, 6, 9, 12, 24, 48* V

\*48 V coil type: Single side stable only

Notes: 1. AgPd stationary contact types available for high resistance against contact sticking.

When ordering, please add suffix "-3" like TQ2-12V-3.

2. M.B.B. contact types are available only for TQ2 type.

## TYPES AND COIL DATA (at 20°C 68°F)

## 1. Standard (B.B.M.) type

## 2 Form C type

## 1. Single side stable

Part No.		Nominal voltage, V DC	Pick-up voltage, V DC (max.)	Drop-out voltage, V DC (min.)	Nominal operating current, mA (±10%)	Coil resistance, Ω (±10%)	Nominal operating power, mW	Max. allowable voltage, V DC
Standard PC board terminal	Self-clinching terminal							
TQ2-3 V	TQ2H-3 V	3	2.25	0.3	46.7	64.3	140	4.5
TQ2-4.5 V	TQ2H-4.5 V	4.5	3.38	0.45	31.1	144.6	140	6.7
TQ2-5 V	TQ2H-5 V	5	3.75	0.5	28.1	178	140	7.5
TQ2-6 V	TQ2H-6 V	6	4.5	0.6	23.3	257	140	9
TQ2-9 V	TQ2H-9 V	9	6.75	0.9	15.5	579	140	13.5
TQ2-12 V	TQ2H-12 V	12	9	1.2	11.7	1,028	140	18
TQ2-24 V	TQ2H-24 V	24	18	2.4	8.3	2,880	200	36
TQ2-48 V	TQ2H-48 V	48	36	4.8	6.25	7,680	300	57.6

## 2. 1 Coil latching

Part No.		Nominal voltage, V DC	Set voltage, V DC (max.)	Reset voltage, V DC (min.)	Nominal operating current, mA (±10%)	Coil resistance, Ω (±10%)	Nominal operating power, mW	Max. allowable voltage, V DC
Standard PC board terminal	Self-clinching terminal							
TQ2-L-3 V	TQ2H-L-3 V	3	2.25	2.25	33.3	90	100	4.5
TQ2-L-4.5 V	TQ2H-L-4.5 V	4.5	3.38	3.38	22.2	202.5	100	6.7
TQ2-L-5 V	TQ2H-L-5 V	5	3.75	3.75	20	250	100	7.5
TQ2-L-6 V	TQ2H-L-6 V	6	4.5	4.5	16.7	360	100	9
TQ2-L-9 V	TQ2H-L-9 V	9	6.75	6.75	11.1	810	100	13.5
TQ2-L-12 V	TQ2H-L-12 V	12	9	9	8.3	1,440	100	18
TQ2-L-24 V	TQ2H-L-24 V	24	18	18	6.3	3,840	150	36

## 3. 2 Coil latching

Part No.		Nominal voltage, V DC	Set voltage, V DC (max.)	Reset voltage, V DC (min.)	Nominal operating current, mA (±10%)	Coil resistance, Ω (±10%)	Nominal operating power, mW	Max. allowable voltage, V DC
Standard PC board terminal	Self-clinching terminal							
TQ2-L2-3 V	TQ2H-L2-3 V	3	2.25	2.25	66.7	45	200	4.5
TQ2-L2-4.5 V	TQ2H-L2-4.5 V	4.5	3.38	3.38	44.4	101.2	200	6.7
TQ2-L2-5 V	TQ2H-L2-5 V	5	3.75	3.75	40	125	200	7.5
TQ2-L2-6 V	TQ2H-L2-6 V	6	4.5	4.5	33.3	180	200	9
TQ2-L2-9 V	TQ2H-L2-9 V	9	6.75	6.75	22.2	405	200	13.5
TQ2-L2-12 V	TQ2H-L2-12 V	12	9	9	16.7	720	200	18
TQ2-L2-24 V	TQ2H-L2-24 V	24	18	18	12.5	1,920	300	28.8

Notes: 1. Specified value of the pick-up, drop-out, set and reset voltage is with the condition of square wave coil pulse.

2. Standard packing: Tube: 50 pcs.; Case: 1,000 pcs.

3. In case of 5 V transistor drive circuit, it is recommend to use 4.5 V type relay.

4. AgPd stationary contact types available for high resistance against contact sticking. When ordering, please add suffix "-3" like TQ2-12V-3.

**4 Form C type****1. Single side stable**

Part No.		Nominal voltage, V DC	Pick-up voltage, V DC (max.)	Drop-out voltage, V DC (min.)	Nominal operating current, mA ( $\pm 10\%$ )	Coil resistance, $\Omega$ ( $\pm 10\%$ )	Nominal operating power, mW	Max. allowable voltage, V DC
Standard PC board terminal	Self-clinching terminal							
TQ4-3 V	TQ4H-3 V	3	2.25	0.3	93.8	32	280	4.5
TQ4-4.5 V	TQ4H-4.5 V	4.5	3.38	0.45	62.2	72.3	280	6.7
TQ4-5 V	TQ4H-5 V	5	3.75	0.5	56.2	89	280	7.5
TQ4-6 V	TQ4H-6 V	6	4.5	0.6	46.5	129	280	9
TQ4-9 V	TQ4H-9 V	9	6.75	0.9	31.1	289	280	13.5
TQ4-12 V	TQ4H-12 V	12	9	1.2	23.3	514	280	18
TQ4-24 V	TQ4H-24 V	24	18	2.4	11.7	2,056	280	36
TQ4-48 V	TQ4H-48 V	48	36	4.8	8.3	5,760	400	57.6

**2. 1 Coil latching**

Part No.		Nominal voltage, V DC	Set voltage, V DC (max.)	Reset voltage, V DC (min.)	Nominal operating current, mA ( $\pm 10\%$ )	Coil resistance, $\Omega$ ( $\pm 10\%$ )	Nominal operating power, mW	Max. allowable voltage, V DC
Standard PC board terminal	Self-clinching terminal							
TQ4-L-3 V	TQ4H-L-3 V	3	2.25	2.25	66.6	45	200	4.5
TQ4-L-4.5 V	TQ4H-L-4.5 V	4.5	3.38	3.38	44.4	101.2	200	6.7
TQ4-L-5 V	TQ4H-L-5 V	5	3.75	3.75	40	125	200	7.5
TQ4-L-6 V	TQ4H-L-6 V	6	4.5	4.5	33.3	180	200	9
TQ4-L-9 V	TQ4H-L-9 V	9	6.75	6.75	22.2	405	200	13.5
TQ4-L-12 V	TQ4H-L-12 V	12	9	9	16.7	720	200	18
TQ4-L-24 V	TQ4H-L-24 V	24	18	18	8.3	2,880	200	36

**3. 2 Coil latching**

Part No.		Nominal voltage, V DC	Set voltage, V DC (max.)	Reset voltage, V DC (min.)	Nominal operating current, mA ( $\pm 10\%$ )	Coil resistance, $\Omega$ ( $\pm 10\%$ )	Nominal operating power, mW	Max. allowable voltage, V DC
Standard PC board terminal	Self-clinching terminal							
TQ4-L2-3 V	TQ4H-L2-3 V	3	2.25	2.25	133	22.5	400	4.5
TQ4-L2-4.5 V	TQ4H-L2-4.5 V	4.5	3.38	3.38	88.9	50.6	400	6.7
TQ4-L2-5 V	TQ4H-L2-5 V	5	3.75	3.75	80	62.5	400	7.5
TQ4-L2-6 V	TQ4H-L2-6 V	6	4.5	4.5	66.6	90	400	9
TQ4-L2-9 V	TQ4H-L2-9 V	9	6.75	6.75	44.4	202.5	400	13.5
TQ4-L2-12 V	TQ4H-L2-12 V	12	9	9	33.3	360	400	18
TQ4-L2-24 V	TQ4H-L2-24 V	24	18	18	16.7	1,440	400	36

Notes: 1. Specified value of the pick-up, drop-out, voltage is with the condition of square wave coil pulse.

2. Standard packing: Tube: 25 pcs.; Case: 500 pcs.

3. In case of 5 V transistor drive circuit, it is recommend to use 4.5 V type relay.

4. 1 coil latching and 2 coil latching types are also available by request. Please consult us for details.

5. AgPd stationary contact types available for high resistance against contact sticking. When ordering, please add suffix "-3" like TQ2-12V-3.

**2. M.B.B. type****Single side stable**

Part No.		Nominal voltage, V DC	Pick-up voltage, V DC (max.)	Drop-out voltage, V DC (min.)	Nominal operating current, mA ( $\pm 10\%$ )	Coil resistance, $\Omega$ ( $\pm 10\%$ )	Nominal operating power, mW	Max. allowable voltage, V DC
Standard PC board terminal	Self-clinching terminal							
TQ2-2M-3 V	TQ2H-2M-3 V	3	2.4	0.3	66.7	45	200	4.5
TQ2-2M-4.5 V	TQ2H-2M-4.5 V	4.5	3.6	0.45	44.4	101	200	6.7
TQ2-2M-5 V	TQ2H-2M-5 V	5	4	0.5	40	125	200	7.5
TQ2-2M-6 V	TQ2H-2M-6 V	6	4.8	0.6	33.3	180	200	9
TQ2-2M-9 V	TQ2H-2M-9 V	9	7.2	0.9	22.2	405	200	13.5
TQ2-2M-12 V	TQ2H-2M-12 V	12	9.6	1.2	16.7	720	200	18
TQ2-2M-24 V	TQ2H-2M-24 V	24	19.2	2.4	8.3	2,880	200	36

Notes: 1. Specified value of the pick-up, drop-out, set and reset voltage is with the condition of square wave coil pulse.

2. Standard packing: Tube: 50 pcs.; Case: 1,000 pcs.

3. In case of 5 V transistor drive circuit, it is recommend to use 4.5 V type relay.

4. AgPd stationary contact types available for high resistance against contact sticking. When ordering, please add suffix "-3" like TQ2-12V-3.

1) 2 Form C, 2 Form D



Standard PC board terminal

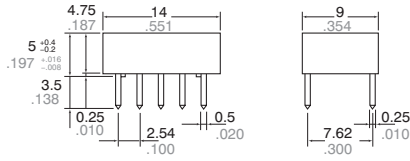

PC board pattern (Copper-side view)

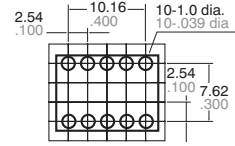

Tolerance:  $\pm 0.1 \pm 0.04$

Self-clinching terminal

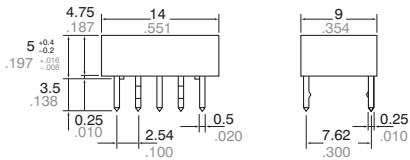

Schematic (Bottom view)

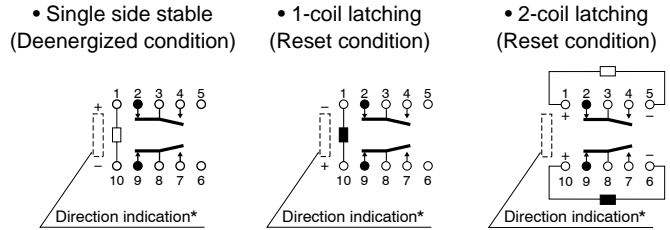

General tolerance:  $\pm 0.3 \pm 0.012$

\*Orientation stripe typical-located on top of relay

2) 4 Form C



Standard PC board terminal

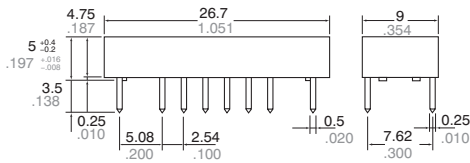

PC board pattern (Copper-side view)

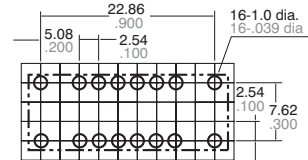

Tolerance:  $\pm 0.1 \pm 0.04$

Self-clinching terminal

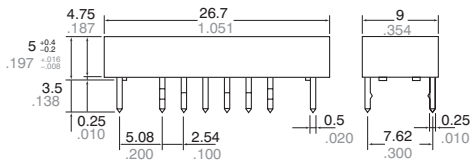

Schematic (Bottom view)

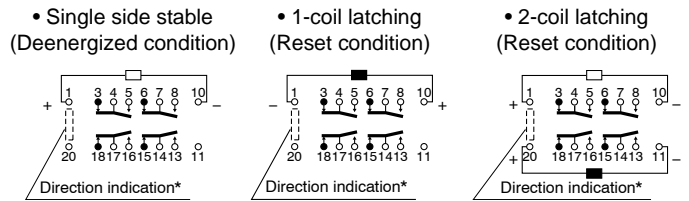

General tolerance:  $\pm 0.3 \pm 0.012$

\*Orientation stripe typical-located on top of relay

**REFERENCE DATA**

1. Maximum switching capacity

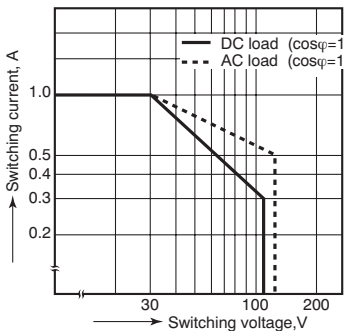

2. Life curve

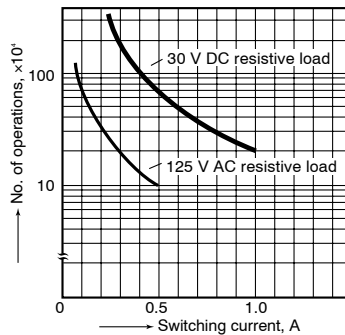

3. Mechanical life

Tested sample: TQ2-12V, 10 pcs.

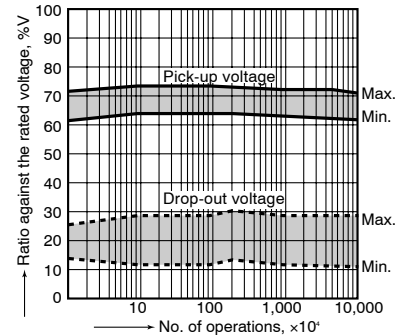

4.-(1) Electrical life (DC load)

Tested sample: TQ2-12V, 6 pcs.  
Condition: 1 A 30 V DC resistive load, 20 cpm  
Change of pick-up and drop-out voltage

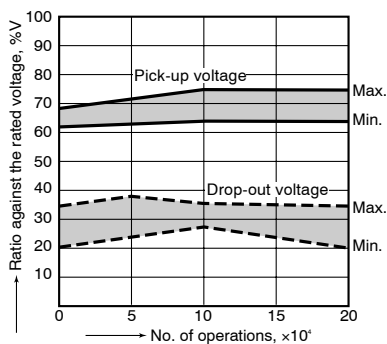

Change of contact resistance

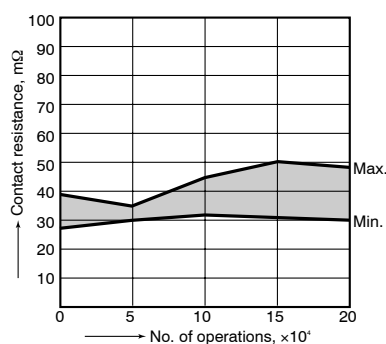

4.-(2) Electrical life (AC load)

Tested sample: TQ2-12V, 6 pcs.  
Condition: 0.5 A 125 V AC resistive load, 20 cpm  
Change of pick-up and drop-out voltage

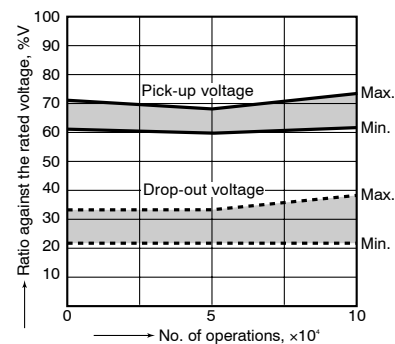

Change of contact resistance

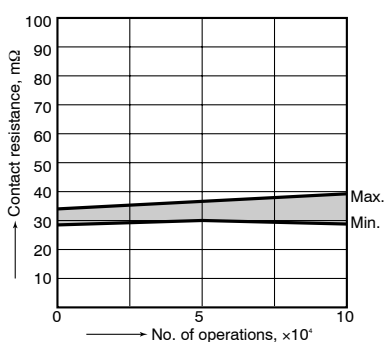

5.-(1) Coil temperature rise (2C)

Tested sample: TQ2-12V  
Measured portion: Inside the coil  
Ambient temperature: 30°C 86°F

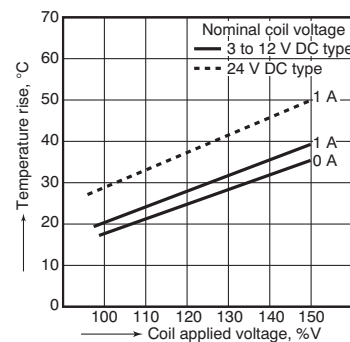

5.-(2) Coil temperature rise (4C)

Tested sample: TQ4-12V  
Measured portion: Inside the coil  
Ambient temperature: 30°C 86°F

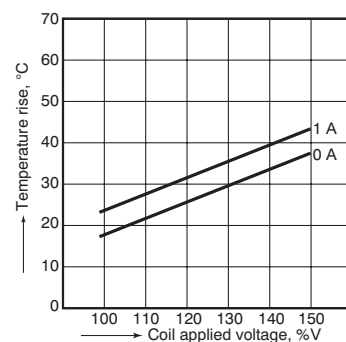

6.-(1) Operate/release time characteristics

Tested sample: TQ2-12V, 10 pcs.

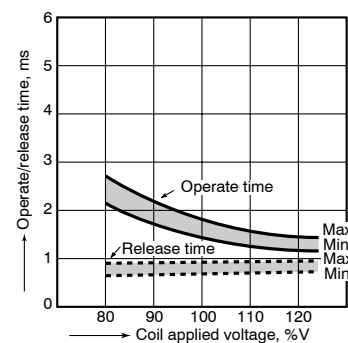

6.-(2) Operate/release time characteristics

Tested sample: TQ4-12V, 10 pcs.

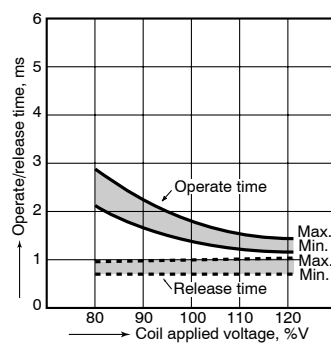

7. Distribution of pick-up and drop-out voltages

Tested sample: TQ2-12V, 50 pcs.

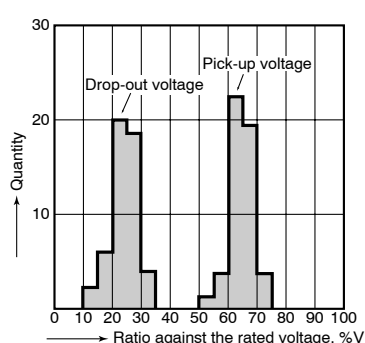

8. Distribution of set and reset voltage

Tested sample: TQ2-L2-12V, 35 pcs.

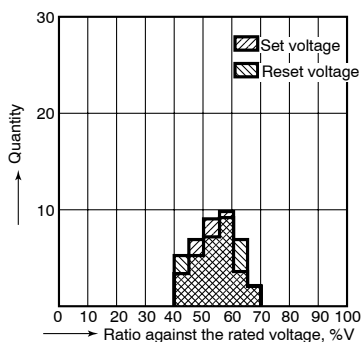

9. Ambient temperature characteristics

Tested sample: TQ2-12V, 5 pcs.

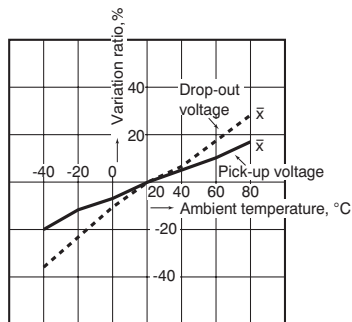

10. Distribution of contact resistance

Tested sample: TQ2-12V, 30 pcs. (30×4 contacts)

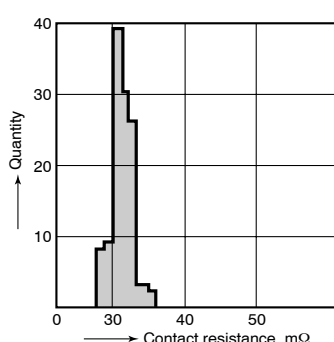

11.-(1) High-frequency characteristics  
Isolation characteristics

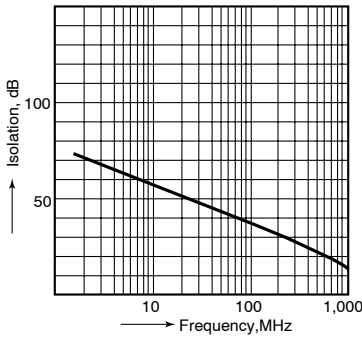

11.-(2) High-frequency characteristics  
Insertion loss characteristics

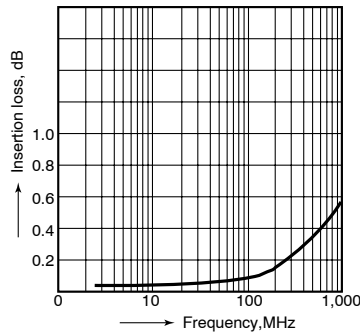

11.-(3) High-frequency characteristics  
V.S.W.R.

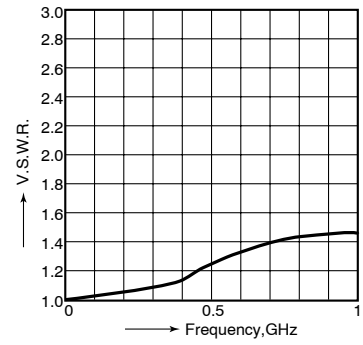

12.-(1) Malfunctional shock (single side stable)  
Tested sample: TQ2-12V, 6 pcs.

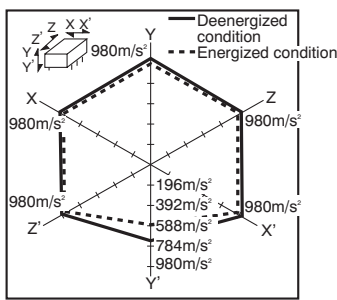

12.-(2) Malfunctional shock (latching)  
Tested sample: TQ2-L-12V, 6 pcs.

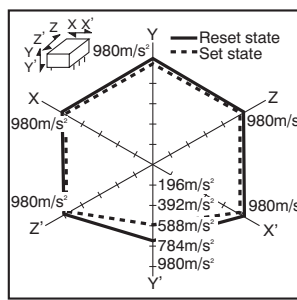

13.-(1) Influence of adjacent mounting

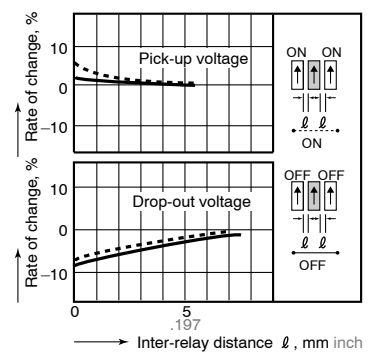

13.-(2) Influence of adjacent mounting

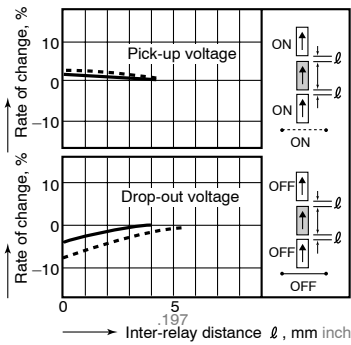

13.-(3) Influence of adjacent mounting

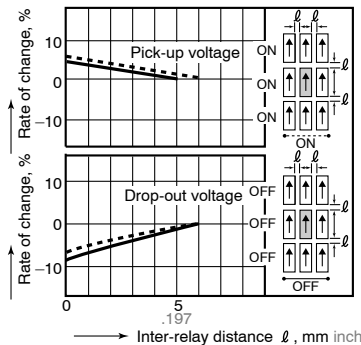

14.-(1) Contact reliability  
(1 mA 5 V DC resistive load)  
Tested sample: TQ2-12V  
Condition: Detection level 10 W

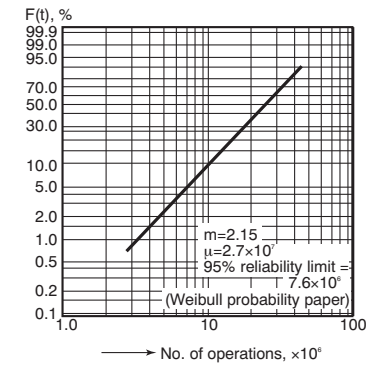

14.-(2) Contact reliability  
(100 μA 5 V DC resistive load)  
Tested sample: TQ2-12V  
Condition: Detection level 100 Ω

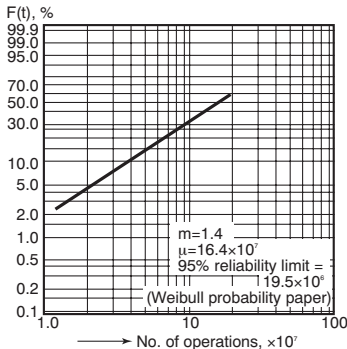

15. Actual load test (35 mA 48 V DC wire spring relay load)

Circuit

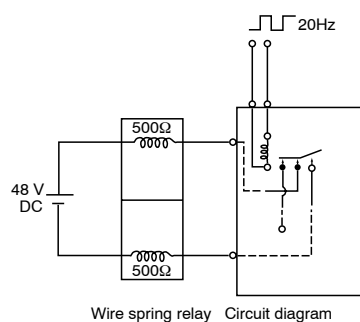

Change of pick-up and drop-out voltage

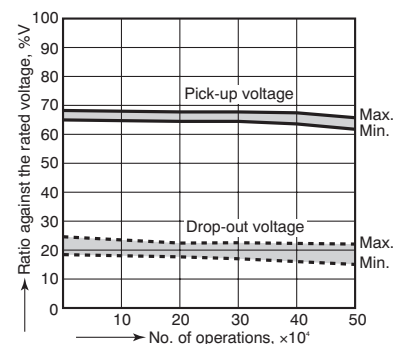

Change of contact resistance

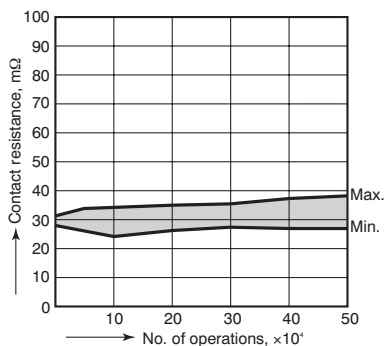

16. 0.1 A 53 V DC resistive load test  
Change of pick-up and drop-out voltage

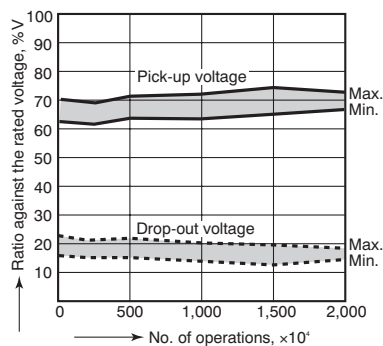

Change of contact resistance

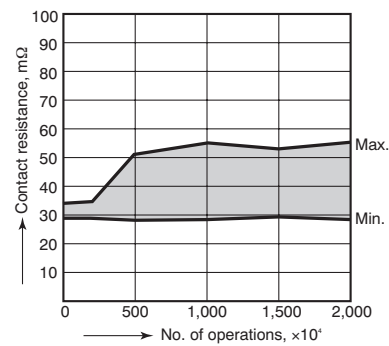

17.-(1) Distribution of M.B.B. time

Sample: TQ2-2M-5V, 85 pcs.

Terminal Nos. 2-3-4: ON

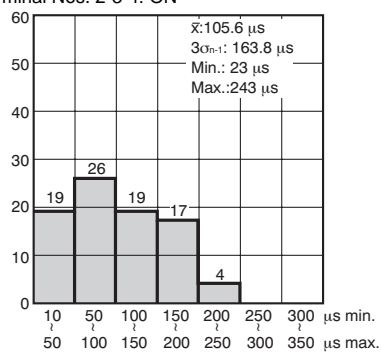

Terminal Nos. 2-3-4: OFF

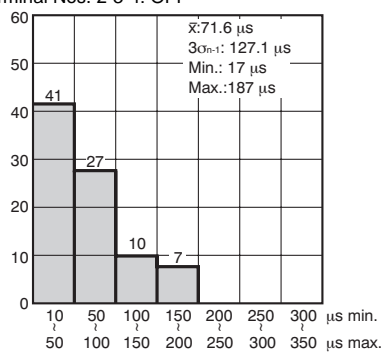

17.-(2) Distribution of M.B.B. time

Sample: TQ2-2M-5V, 85 pcs.

Terminal Nos. 7-8-9: ON

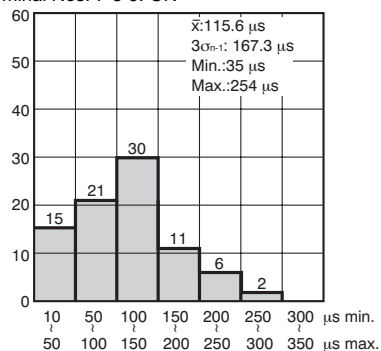

Terminal Nos. 7-8-9: OFF

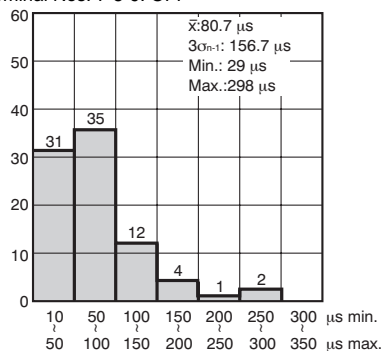

For Cautions for Use, see [Relay Technical Information](#).