



















- 1 
- 2 
- 3 
- 4 
- 5 
- 6 
- 7 
- 8 
- 9 
- 10 
- 11 
- 12 
- 13 
- 14 
- 15 
- 16 
- 17 
- 18 

## BASE

Glass-fibre reinforced polyamide based (PA) technopolymer, black colour, matte finish.

## ARTICULATED STEM

Threaded zinc-plated steel with regulation hexagon.

## STANDARD EXECUTIONS

- LV.A: without no-slip disk.
- LV.A-AS: with NBR rubber no-slip disk, hardness 70 Shore A, supplied assembled to the base.

## FEATURES

The special knurling under the lower lip of the base provides excellent stability and grip when using the levelling element without no-slip disk even on surfaces that are not perfectly flat.

The particular assembling system of the no-slip disk to the base assures a perfect anchoring, preventing separation even in case of impact during transport or of adhesion (sticking) to the floor (see No-slip disks on page 1137).

## ORDER INFORMATION

The levelling elements are supplied unassembled to make carriage and storage easier. The components (base and stem) are supplied in separate packing: less volume taken and better protection from scratches and dirt.

To order bases and stems separately, see:

- table of possible combinations Bases/Stems (see page 1144)
- the codes of the Bases (see page 1139)
- the codes of the Stems (see page 1142).

## ACCESSORIES ON REQUEST

Zinc-plated steel nut (see Nuts NT, on page 1137).



ELESA Original design

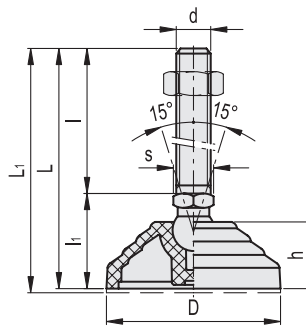

## LV.A

## LV.A-AS

Code	Description	Code	Description	D	d	L	L1#	l	li	h	s	Articulation ∅	Max. limit stati load* [N]	#	#
303121	LV.A-60-14-M8x43	307121	LV.A-60-14-AS-M8x43	60	M8	76	79	43	33	24	14	14	14000	62	81
303125	LV.A-60-14-M8x68	307125	LV.A-60-14-AS-M8x68	60	M8	101	104	68	33	24	14	14	14000	74	93
303221	LV.A-60-14-M10x43	307221	LV.A-60-14-AS-M10x43	60	M10	76	79	43	33	24	14	14	14000	71	90
303225	LV.A-60-14-M10x68	307225	LV.A-60-14-AS-M10x68	60	M10	101	104	68	33	24	14	14	14000	83	102
303231	LV.A-60-14-M10x98	307231	LV.A-60-14-AS-M10x98	60	M10	131	134	98	33	24	14	14	14000	97	116
303321	LV.A-60-14-M12x43	307321	LV.A-60-14-AS-M12x43	60	M12	76	79	43	33	24	14	14	14000	81	100
303325	LV.A-60-14-M12x68	307325	LV.A-60-14-AS-M12x68	60	M12	101	104	68	33	24	14	14	14000	98	117
303331	LV.A-60-14-M12x98	307331	LV.A-60-14-AS-M12x98	60	M12	131	134	98	33	24	14	14	14000	119	138
303421	LV.A-60-14-M14x68	307421	LV.A-60-14-AS-M14x68	60	M14	101	104	68	33	24	14	14	14000	123	139
303431	LV.A-60-14-M14x98	307431	LV.A-60-14-AS-M14x98	60	M14	131	134	98	33	24	14	14	14000	144	160
303441	LV.A-60-14-M14x148	307441	LV.A-60-14-AS-M14x148	60	M14	181	184	148	33	24	14	14	14000	227	243
303521	LV.A-60-14-M16x68	307521	LV.A-60-14-AS-M16x68	60	M16	101	104	68	33	24	16	14	14000	142	161
303525	LV.A-60-14-M16x108	307525	LV.A-60-14-AS-M16x108	60	M16	141	144	108	33	24	16	14	14000	194	213
303541	LV.A-60-14-M16x148	307541	LV.A-60-14-AS-M16x148	60	M16	181	184	148	33	24	16	14	14000	246	265
303561	LV.A-60-14-M16x168	307561	LV.A-60-14-AS-M16x168	60	M16	201	204	168	33	24	16	14	14000	272	291

\* The max static load is the value above which the load applied to the element may cause some plastic material breakage, in particular conditions of use. Obviously, a factor that takes into consideration the importance and the safety level of the specific application must be applied to this value.

# Data with no-slip disk mounted.



LVA		LVA-AS												Max. limit stati load* [N]		⚖️ #	
Code	Description	Code	Description	D	d	L	Lt#	l	lt	h	s	Articulation ∅					
303621	LVA-60-24-M16x58	307621	LVA-60-24-AS-M16x58	60	M16	101	104	58	43	24	24	24	18000	205	224		
303625	LVA-60-24-M16x98	307625	LVA-60-24-AS-M16x98	60	M16	141	144	98	43	24	24	24	18000	256	275		
303641	LVA-60-24-M16x138	307641	LVA-60-24-AS-M16x138	60	M16	181	184	138	43	24	24	24	18000	306	325		
303661	LVA-60-24-M16x158	307661	LVA-60-24-AS-M16x158	60	M16	201	204	158	43	24	24	24	18000	333	352		
303725	LVA-60-24-M20x98	307725	LVA-60-24-AS-M20x98	60	M20	141	144	98	43	24	24	24	18000	326	345		
303741	LVA-60-24-M20x138	307741	LVA-60-24-AS-M20x138	60	M20	181	184	138	43	24	24	24	18000	405	424		
303761	LVA-60-24-M20x158	307761	LVA-60-24-AS-M20x158	60	M20	201	204	158	43	24	24	24	18000	444	463		
303781	LVA-60-24-M20x198	307781	LVA-60-24-AS-M20x198	60	M20	241	244	198	43	24	24	24	18000	527	546		
303825	LVA-60-24-M24x98	307825	LVA-60-24-AS-M24x98	60	M24	141	144	98	43	24	24	24	18000	424	443		
303861	LVA-60-24-M24x158	307861	LVA-60-24-AS-M24x158	60	M24	201	204	158	43	24	24	24	18000	596	615		
303881	LVA-60-24-M24x198	307881	LVA-60-24-AS-M24x198	60	M24	241	244	198	43	24	24	24	18000	714	733		
304005	LVA-70-14-M8x43	308005	LVA-70-14-AS-M8x43	70	M8	71	74	43	28	19	14	14	14000	60	80		
304011	LVA-70-14-M8x68	308011	LVA-70-14-AS-M8x68	70	M8	96	99	68	28	19	14	14	14000	72	92		
304021	LVA-70-14-M10x43	308021	LVA-70-14-AS-M10x43	70	M10	71	74	43	28	19	14	14	14000	69	89		
304025	LVA-70-14-M10x68	308025	LVA-70-14-AS-M10x68	70	M10	96	99	68	28	19	14	14	14000	81	101		
304031	LVA-70-14-M10x98	308031	LVA-70-14-AS-M10x98	70	M10	126	129	98	28	19	14	14	14000	95	115		
304061	LVA-70-14-M12x43	308061	LVA-70-14-AS-M12x43	70	M12	71	74	43	28	19	14	14	14000	79	99		
304065	LVA-70-14-M12x68	308065	LVA-70-14-AS-M12x68	70	M12	96	99	68	28	19	14	14	14000	96	116		
304071	LVA-70-14-M12x98	308071	LVA-70-14-AS-M12x98	70	M12	126	129	98	28	19	14	14	14000	117	137		
304075	LVA-70-14-M14X68	308075	LVA-70-14-AS-M14X68	70	M14	96	99	68	28	19	14	14	14000	118	138		
304081	LVA-70-14-M14X98	308081	LVA-70-14-AS-M14X98	70	M14	126	129	98	28	19	14	14	14000	139	159		
304085	LVA-70-14-M14X148	308085	LVA-70-14-AS-M14X148	70	M14	176	179	148	28	19	14	14	14000	222	242		
304101	LVA-70-14-M16x68	308101	LVA-70-14-AS-M16x68	70	M16	96	99	68	28	19	16	14	14000	140	160		
304105	LVA-70-14-M16x108	308105	LVA-70-14-AS-M16x108	70	M16	136	139	108	28	19	16	14	14000	192	212		
304111	LVA-70-14-M16x148	308111	LVA-70-14-AS-M16x148	70	M16	176	179	148	28	19	16	14	14000	244	264		
304115	LVA-70-14-M16x168	308115	LVA-70-14-AS-M16x168	70	M16	196	199	168	28	19	16	14	14000	270	290		
304121	LVA-80-14-M8x43	308121	LVA-80-14-AS-M8x43	80	M8	76	79	43	33	24	14	14	16000	83	109		
304125	LVA-80-14-M8x68	308125	LVA-80-14-AS-M8x68	80	M8	101	104	68	33	24	14	14	16000	95	121		
304221	LVA-80-14-M10x43	308221	LVA-80-14-AS-M10x43	80	M10	76	79	43	33	24	14	14	16000	92	118		
304225	LVA-80-14-M10x68	308225	LVA-80-14-AS-M10x68	80	M10	101	104	68	33	24	14	14	16000	104	130		
304231	LVA-80-14-M10x98	308231	LVA-80-14-AS-M10x98	80	M10	131	134	98	33	24	14	14	16000	118	144		
304321	LVA-80-14-M12x43	308321	LVA-80-14-AS-M12x43	80	M12	76	79	43	33	24	14	14	16000	102	128		
304325	LVA-80-14-M12x68	308325	LVA-80-14-AS-M12x68	80	M12	101	104	68	33	24	14	14	16000	119	145		
304331	LVA-80-14-M12x98	308331	LVA-80-14-AS-M12x98	80	M12	131	134	98	33	24	14	14	16000	140	166		
304421	LVA-80-14-M14X68	308421	LVA-80-14-AS-M14X68	80	M14	101	104	68	33	24	14	14	16000	141	167		
304431	LVA-80-14-M14X98	308431	LVA-80-14-AS-M14X98	80	M14	131	134	98	33	24	14	14	16000	162	188		
304441	LVA-80-14-M14X148	308441	LVA-80-14-AS-M14X148	80	M14	181	184	148	33	24	14	14	16000	245	271		
304521	LVA-80-14-M16x68	308521	LVA-80-14-AS-M16x68	80	M16	101	104	68	33	24	16	14	16000	163	189		
304525	LVA-80-14-M16x108	308525	LVA-80-14-AS-M16x108	80	M16	141	144	108	33	24	16	14	16000	215	241		
304541	LVA-80-14-M16x148	308541	LVA-80-14-AS-M16x148	80	M16	181	184	148	33	24	16	14	16000	267	293		
304561	LVA-80-14-M16x168	308561	LVA-80-14-AS-M16x168	80	M16	201	204	168	33	24	16	14	16000	293	319		
304621	LVA-80-24-M16x58	308621	LVA-80-24-AS-M16x58	80	M16	101	104	58	43	24	24	24	18000	225	251		
304625	LVA-80-24-M16x98	308625	LVA-80-24-AS-M16x98	80	M16	141	144	98	43	24	24	24	18000	276	302		
304641	LVA-80-24-M16x138	308641	LVA-80-24-AS-M16x138	80	M16	181	184	138	43	24	24	24	18000	326	352		
304661	LVA-80-24-M16x158	308661	LVA-80-24-AS-M16x158	80	M16	201	204	158	43	24	24	24	18000	353	379		
304725	LVA-80-24-M20x98	308725	LVA-80-24-AS-M20x98	80	M20	141	144	98	43	24	24	24	18000	346	372		
304741	LVA-80-24-M20x138	308741	LVA-80-24-AS-M20x138	80	M20	181	184	138	43	24	24	24	18000	425	451		
304761	LVA-80-24-M20x158	308761	LVA-80-24-AS-M20x158	80	M20	201	204	158	43	24	24	24	18000	464	490		
304781	LVA-80-24-M20x198	308781	LVA-80-24-AS-M20x198	80	M20	241	244	198	43	24	24	24	18000	547	573		
304825	LVA-80-24-M24x98	308825	LVA-80-24-AS-M24x98	80	M24	141	144	98	43	24	24	24	18000	444	470		
304861	LVA-80-24-M24x158	308861	LVA-80-24-AS-M24x158	80	M24	201	204	158	43	24	24	24	18000	616	642		
304881	LVA-80-24-M24x198	308881	LVA-80-24-AS-M24x198	80	M24	241	244	198	43	24	24	24	18000	734	760		

\* The max static load is the value above which the load applied to the element may cause some plastic material breakage, in particular conditions of use. Obviously, a factor that takes into consideration the importance and the safety level of the specific application must be applied to this value.

# Data with no-slip disk mounted.

Levelling elements and supports

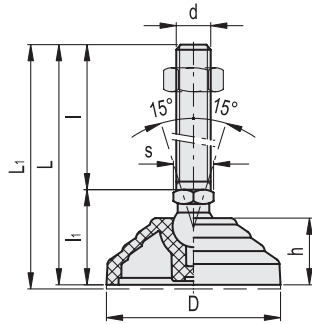
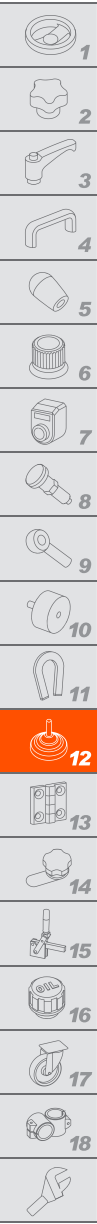

LVA

LV.A-AS

Code	Description	Code	Description	D	d	L	L1#	l	l1	h	s	Articulation ∅	Max. limit stati load* [N]	⚖️	⚖️#
305451	LVA-100-14-M8x43	309451	LV.A-100-14-AS-M8x43	100	M8	76	79	43	33	24	14	14	18000	91	146
305453	LVA-100-14-M8x68	309453	LV.A-100-14-AS-M8x68	100	M8	101	104	68	33	24	14	14	18000	103	158
305461	LVA-100-14-M10x43	309461	LV.A-100-14-AS-M10x43	100	M10	76	79	43	33	24	14	14	18000	100	155
305463	LVA-100-14-M10x68	309463	LV.A-100-14-AS-M10x68	100	M10	101	104	68	33	24	14	14	18000	112	167
305465	LVA-100-14-M10x98	309465	LV.A-100-14-AS-M10x98	100	M10	131	134	98	33	24	14	14	18000	126	181
305471	LVA-100-14-M12x43	309471	LV.A-100-14-AS-M12x43	100	M12	76	79	43	33	24	14	14	18000	110	165
305473	LVA-100-14-M12x68	309473	LV.A-100-14-AS-M12x68	100	M12	101	104	68	33	24	14	14	18000	127	182
305475	LVA-100-14-M12x98	309475	LV.A-100-14-AS-M12x98	100	M12	131	134	98	33	24	14	14	18000	148	203
305477	LVA-100-14-M14X68	309477	LV.A-100-14-AS-M14X68	100	M14	101	104	68	33	24	14	14	18000	149	204
305479	LVA-100-14-M14X98	309479	LV.A-100-14-AS-M14X98	100	M14	131	134	98	33	24	14	14	18000	170	225
305480	LVA-100-14-M14X148	309480	LV.A-100-14-AS-M14X148	100	M14	181	184	148	33	24	14	14	18000	253	308
305481	LVA-100-14-M16x68	309481	LV.A-100-14-AS-M16x68	100	M16	101	104	68	33	24	16	14	18000	171	226
305483	LVA-100-14-M16x108	309483	LV.A-100-14-AS-M16x108	100	M16	141	144	108	33	24	16	14	18000	223	278
305485	LVA-100-14-M16x148	309485	LV.A-100-14-AS-M16x148	100	M16	181	184	148	33	24	16	14	18000	275	330
305487	LVA-100-14-M16x168	309487	LV.A-100-14-AS-M16x168	100	M16	201	204	168	33	24	16	14	18000	301	356
305521	LVA-100-24-M16x58	309521	LV.A-100-24-AS-M16x58	100	M16	101	104	58	43	24	24	24	25000	251	305
305525	LVA-100-24-M16x98	309525	LV.A-100-24-AS-M16x98	100	M16	141	144	98	43	24	24	24	25000	302	356
305541	LVA-100-24-M16x138	309541	LV.A-100-24-AS-M16x138	100	M16	181	184	138	43	24	24	24	25000	352	406
305561	LVA-100-24-M16x158	309561	LV.A-100-24-AS-M16x158	100	M16	201	204	158	43	24	24	24	25000	379	433
305625	LVA-100-24-M20x98	309625	LV.A-100-24-AS-M20x98	100	M20	141	144	98	43	24	24	24	25000	372	426
305641	LVA-100-24-M20x138	309641	LV.A-100-24-AS-M20x138	100	M20	181	184	138	43	24	24	24	25000	451	505
305661	LVA-100-24-M20x158	309661	LV.A-100-24-AS-M20x158	100	M20	201	204	158	43	24	24	24	25000	490	544
305681	LVA-100-24-M20x198	309681	LV.A-100-24-AS-M20x198	100	M20	241	244	198	43	24	24	24	25000	573	627
305725	LVA-100-24-M24x98	309725	LV.A-100-24-AS-M24x98	100	M24	141	144	98	43	24	24	24	25000	470	524
305761	LVA-100-24-M24x158	309761	LV.A-100-24-AS-M24x158	100	M24	201	204	158	43	24	24	24	25000	642	696
305781	LVA-100-24-M24x198	309781	LV.A-100-24-AS-M24x198	100	M24	241	244	198	43	24	24	24	25000	760	814
306521	LVA-125-24-M16x58	310221	LV.A-125-24-AS-M16x58	125	M16	125	128	58	67	46	24	24	28000	386	512
306525	LVA-125-24-M16x98	310225	LV.A-125-24-AS-M16x98	125	M16	165	168	98	67	46	24	24	28000	437	563
306541	LVA-125-24-M16x138	310241	LV.A-125-24-AS-M16x138	125	M16	205	208	138	67	46	24	24	28000	487	613
306561	LVA-125-24-M16x158	310261	LV.A-125-24-AS-M16x158	125	M16	225	228	158	67	46	24	24	28000	514	640
306625	LVA-125-24-M20x98	310325	LV.A-125-24-AS-M20x98	125	M20	165	168	98	67	46	24	24	28000	507	633
306641	LVA-125-24-M20x138	310341	LV.A-125-24-AS-M20x138	125	M20	205	208	138	67	46	24	24	28000	586	712
306661	LVA-125-24-M20x158	310361	LV.A-125-24-AS-M20x158	125	M20	225	228	158	67	46	24	24	28000	625	751
306681	LVA-125-24-M20x198	310381	LV.A-125-24-AS-M20x198	125	M20	265	268	198	67	46	24	24	28000	708	834
306725	LVA-125-24-M24x98	310425	LV.A-125-24-AS-M24x98	125	M24	165	168	98	67	46	24	24	28000	605	731
306761	LVA-125-24-M24x158	310461	LV.A-125-24-AS-M24x158	125	M24	225	228	158	67	46	24	24	28000	777	903
306781	LVA-125-24-M24x198	310481	LV.A-125-24-AS-M24x198	125	M24	265	268	198	67	46	24	24	28000	895	1021

\* The max static load is the value above which the load applied to the element may cause some plastic material breakage, in particular conditions of use. Obviously, a factor that takes into consideration the importance and the safety level of the specific application must be applied to this value.

# Data with no-slip disk mounted.