

Light



The right lighting can make all the difference to the atmosphere of a home, office or outdoor space. That's why GET has put a great deal of thought into a range of lighting luminaires that are both aesthetically pleasing and easy to install.

For indoor use, choose between mood enhancing, decorative luminaires and more functional fittings for kitchens, bathrooms and commercial spaces.

And why stay indoors on a warm summer evening, when external lighting will create the perfect al fresco environment? GET's range of outdoor lighting solutions can illuminate gardens, walkways and doorways – or offer a little extra security.

New for this edition are fire rated downlighters and T4 mini batten fluorescent fittings.

Indoor	120-141
Downlighters	120-130
Fire rated	121
Die cast	122
Pressed	123
Shower lights	122
Die cast with floating glass	124
Transformers	125
Recessed wall and ceiling	126-127
T4 mini batten	129
Cabinet and undershelf lighting	130
Bathroom range	131-134
Wall and ceiling	132
Shaver lights	133
Shower lights	134
Decorative range	135-139
GU10 Spotlights	136
GU10 Flat plate	137
Compact fluorescents	137
G9 Spotlight	138
Wall and Ceiling	139
Fluorescent battens & diffusers	140-141
Battens	141
Diffusers	141
Reflectors	141
Outdoor	142-157
Amenity	142-144
Drums	143
Bulk head and bricklights	144
Flood lighting	144
Low voltage	145-154
Ezclick system	146
LED decklights	147
Tall post lights	148
Pagoda, spotlights + postlights	148
Decklights, spotlights + bollards	149
Stone effect post lights	150
6 sided lanterns	150
Stone effect novelty	151
Caplights + stormlights	152
Lanterns + halo postlights	153
Pagoda postlights	154
Mains voltage	155-157
Tall postlights	156
Stainless steel posts	156
Steel + copper lanterns	156
Traditional + modern style lanterns	157
Lamps	158-164
Incandescent	159-160
Halogen	160-162
Energy saving	163
Compact fluorescent	163
T4 + T5 miniature fluorescent	164
Energy saving lampholder	164
Technical information	190-195

Lighting Solutions...

...for domestic,
commercial
and industrial
applications



Fire Rated Downlighters –
Page 121



Downlighters – Pages 122-123



T4 Mini Batten Luminaires –
Page 129



Cabinet Lighting – Page 130



Bathroom Lighting –
Pages 131-133



Batten Fittings - Pages 140-141



Amenity Lighting – Pages 142-144



Outdoor Low Voltage Lighting –
Pages 145-154



Energy Saving – Page 161



Lamps – Pages 158-164



new lighting products



Fire rated downlighters

The new range of fire and acoustic rated Downlights from GET is the ideal choice for commercial or domestic installations. Supplied in fixed, tilt or shower versions, in chrome, white or stainless steel finishes and available for mains or low voltage applications.

Downlighters – Page 121



Fire rated downlighters

Maintain fire resistance of load bearing floors for up to 90 minutes. Acoustic rating to BS EN ISO 140-3:1995 and 140-6:1998.

Downlighters – Page 121



T4 mini batten luminaires

Provide ambience to any kitchen work surface with GET's new range of T4 Mini Batten Fittings. Supplied in 275mm, 400mm, 500mm and 625mm versions, all mini battens can be interconnected directly or with the supplied link cable.

Mini battens – Page 129

T4 mini batten lighting

Quality mini battens to BS EN 60598 with CE and F Mark approval.

Mini battens – Page 129





Light | Indoor lighting | Downlighters

Our versatile downlighter range can add simple, understated ambience or direct accent lighting to any domestic or commercial area. With a wide choice of lamp types and finishes as well as ceiling, wall or stair models. Our luminaires will complement any interior styling.

The low voltage and GU10 ranges found on pages 122-123 have been colour matched with a choice of seven high quality finishes to complement our Ultimate wiring accessory range (see pages 20-57).

Downlighter range

Fire rated: GU10/Low voltage	Page 121
Die cast: GU10/Low voltage	Page 122
Pressed metal: GU10/Low voltage	Page 123
Die cast with floating glass: GU10/Low voltage	Page 124
This section also features:	
Transformers: Low voltage	Page 125
Wall, stair and ceiling (matt steel) LED, Low voltage, G9	Pages 126-127

Light | Indoor lighting | Downlighters

Fire rated - low voltage and mains halogen



Low voltage MR16 halogen downlighters (lamp included)



Code	Description	Qty
Fixed		
GDFLLD50C	Chrome	10
GDFLLD50W	White	10
GDFLLD50SS	Stainless steel	10

Lamp: MR16 (50W max)
Cut-out (mm): 72mm
Ceiling Depth: 100mm



Code	Description	Qty
Tilt		
GDFLLTD50C	Chrome	10
GDFLLTD50W	White	10
GDFLLTD50SS	Stainless steel	10

Lamp: MR16 (50W max)
Cut-out (mm): 83mm
Ceiling Depth: 100mm



Code	Description	Qty
Shower		
GDFLLS50C	Chrome	10
GDFLLS50W	White	10
GDFLLS50SS	Stainless steel	10

Lamp: MR16 (50W max)
Cut-out (mm): 74mm
Ceiling Depth: 100mm

Features:

- Max rating 50W when used with aluminised lamp (code HD50WM2582A). When used with non-aluminised lamps max rating of lamp must be 35W.
- Shower version rated to IP65 and can be installed in zones 1, 2 and 3 (see page 133).

Mains voltage GU10 halogen downlighters (lamp included)



Code	Description	Qty
Fixed		
GDFLGD50C	Chrome	10
GDFLGD50W	White	10
GDFLGD50SS	Stainless steel	10

Lamp: GU10 (50W max)
Cut-out (mm): 72mm
Ceiling Depth: 100mm



Code	Description	Qty
Tilt		
GDFLGTD50C	Chrome	10
GDFLGTD50W	White	10
GDFLGTD50SS	Stainless steel	10

Lamp: GU10 (50W max)
Cut-out (mm): 83mm
Ceiling Depth: 100mm



Code	Description	Qty
Shower		
GDFLGS50C	Chrome	10
GDFLGS50W	White	10
GDFLGS50SS	Stainless steel	10

Lamp: GU10 (50W max)
Cut-out (mm): 74mm
Ceiling Depth: 100mm

Features:

- Maintain fire resistance of load bearing floors for up to 90 minute ceilings to BS476 parts 20, 21 and 23
- Moisture resistant seals for fixed version
- Die cast construction c/w stirrup and enclosed terminal block
- Quick fix steel clips to ensure secure fixing
- Shower version rated to IP65
- Acoustic rating to BS EN ISO 140-3: 1995 and 140-6 1998

Light | Indoor lighting | Downlighters

Die cast metal – low voltage and mains halogen



Low voltage MR16 halogen downlighters (lamp required)

	Code	Description	Qty	
 GDLLD50C	Fixed			
	GDLLD50B	Polished brass	6	Lamp: MR16 (50W max)
	GDLLD50C	Polished chrome	6	Cut-out (mm): 60mm
	GDLLD50W	White	6	Ceiling Depth: 116mm
	GDLLD50BB	Brushed brass	6	Diameter: 80mm
	GDLLD50CB	Brushed chrome	6	
	GDLLD50BN	Black nickel	6	
	GDLLD50PN	Pearl nickel	6	
	GDLLD50SS	Stainless steel	6	
 GDLLTD50BN	Tilt			
	GDLLTD50B	Polished brass	6	Lamp: MR16 (50W max)
	GDLLTD50C	Polished chrome	6	Cut-out (mm): 65mm
	GDLLTD50W	White	6	Ceiling Depth: 116mm
	GDLLTD50BB	Brushed brass	6	Diameter: 80mm
	GDLLTD50CB	Brushed chrome	6	
	GDLLTD50BN	Black nickel	6	
	GDLLTD50PN	Pearl nickel	6	
	GDLLTD50SS	Stainless steel	6	
 GDLLW50BB	Wall wash			
	GDLLW50B	Polished brass	6	Lamp: MR16 (50W max)
	GDLLW50C	Polished chrome	6	Cut-out (mm): 110mm
	GDLLW50W	White	6	Ceiling Depth: 105mm
	GDLLW50BB	Brushed brass	6	Diameter: 127mm
	GDLLW50CB	Brushed chrome	6	
 GDLLS50B	Shower			
	GDLLS50B	Brass	1	Lamp: MR16 (50W max)
	GDLLS50C	Chrome	1	Cut-out (mm): 72.5mm
	GDLLS50W	White	1	Ceiling Depth: 100mm
	GDLLS50SS	Stainless steel	1	Diameter: 83mm
	GDLLS50BN	Black nickel	1	Suitable for use in Zone 1
	GDLLS50BS	Satin brass	1	• Shower version rated to IP65
	GDLLS50PN	Pearl nickel	1	

Mains voltage GU10 halogen downlighters (lamp included)

	Code	Description	Qty	
 GDLGD50CB	Fixed			
	GDLGD50B	Polished brass	6	Lamp: GU10 (50W max)
	GDLGD50C	Polished chrome	6	Cut-out (mm): 60mm
	GDLGD50W	White	6	Ceiling Depth: 116mm
	GDLGD50BB	Brushed brass	6	Diameter: 80mm
	GDLGD50CB	Brushed chrome	6	
	GDLGD50BN	Black nickel	6	
	GDLGD50PN	Pearl nickel	6	
	GDLGD50SS	Stainless steel	6	
 GDLGTD50PN	Tilt			
	GDLGTD50B	Polished brass	6	Lamp: GU10 (50W max)
	GDLGTD50C	Polished chrome	6	Cut-out (mm): 65mm
	GDLGTD50W	White	6	Ceiling Depth: 116mm
	GDLGTD50BB	Brushed brass	6	Diameter: 80mm
	GDLGTD50CB	Brushed chrome	6	
	GDLGTD50BN	Black nickel	6	
	GDLGTD50PN	Pearl nickel	6	
	GDLGTD50SS	Stainless steel	6	
 GDLGS50B	Shower			
	GDLGS50B	Brass	1	Lamp: GU10 (50W max)
	GDLGS50C	Chrome	1	Cut-out (mm): 72.5mm
	GDLGS50W	White	1	Ceiling Depth: 100mm
	GDLGS50SS	Stainless steel	1	Diameter: 83mm
	GDLGS50BN	Black nickel	1	Suitable for use in Zone 1
	GDLGS50BS	Satin brass	1	• Shower version rated to IP65
	GDLGS50PN	Pearl nickel	1	

Light | Indoor lighting | Downlighters

Pressed metal – low voltage and mains halogen



Low voltage MR16 downlighters (lamp required)



Code	Description	Qty
Fixed		
GDLL50B	Polished brass	6
GDLL50C	Polished chrome	6
GDLL50W	White	6
GDLL50BB	Brushed brass	6
GDLL50CB	Brushed chrome	6
GDLL50BN	Black nickel	6

Lamp:	MR16 (50W max)
Cut-out (mm):	65mm
Ceiling Depth:	116mm
Diameter:	80mm



Eyeball		
GDLL50B	Polished brass	6
GDLL50C	Polished chrome	6
GDLL50W	White	6
GDLL50BB	Brushed brass	6
GDLL50CB	Brushed chrome	6
GDLL50BN	Black nickel	6

Lamp:	MR16 (50W max)
Cut-out (mm):	95mm
Ceiling Depth:	125mm
Diameter:	110mm



Tilt		
GDLL50B	Polished brass	6
GDLL50C	Polished chrome	6
GDLL50W	White	6
GDLL50BB	Brushed brass	6
GDLL50CB	Brushed chrome	6
GDLL50BN	Black nickel	6

Lamp:	MR16 (50W max)
Cut-out (mm):	80mm
Ceiling Depth:	116mm
Diameter:	105mm

Mains voltage GU10 downlighters (lamp included)



Code	Description	Qty
Fixed		
GDLG50B	Polished brass	6
GDLG50C	Polished chrome	6
GDLG50W	White	6
GDLG50BB	Brushed brass	6
GDLG50CB	Brushed chrome	6
GDLG50BN	Black nickel	6

Lamp:	GU10 (50W max)
Cut-out (mm):	65mm
Ceiling Depth:	116mm
Diameter:	80mm



Eyeball		
GDLGE50B	Polished brass	6
GDLGE50C	Polished chrome	6
GDLGE50W	White	6
GDLGE50BB	Brushed brass	6
GDLGE50CB	Brushed chrome	6
GDLGE50BN	Black nickel	6

Lamp:	GU10 (50W max)
Cut-out (mm):	95mm
Ceiling Depth:	125mm
Diameter:	110mm



Tilt		
GDLGT50B	Polished brass	6
GDLGT50C	Polished chrome	6
GDLGT50W	White	6
GDLGT50BB	Brushed brass	6
GDLGT50CB	Brushed chrome	6
GDLGT50BN	Black nickel	6

Lamp:	GU10 (50W max)
Cut-out (mm):	80mm
Ceiling Depth:	116mm
Diameter:	105mm

Features:

- Fixed, eyeball and tilt models
- Complete with stirrup and covered terminal block, quick fit steel spring clips and a lamp retaining clip
- For use with max 50W MR16 dichroic lamp (not included) or mains voltage GU10 lamp (included)
- Individually boxed
- Dichroic lamps reflect the heat backwards to provide a cool beam while GU10 lamps reflect heat forwards
- Suitable for commercial and domestic applications

A range of pressed downlighters that are suitable for both domestic and commercial applications. The range is available in six finishes to suit a variety of interior styles and can be easily installed.



Light | Indoor lighting | Downlighters

Die cast with floating glass – low voltage and GU10



Floating glass (lamp not included)



GDLLG50B

Code	Colour	Description	Qty
GDLLG50B	Brass	Downlighter with floating glass	1
GDLLG50C	Chrome	Downlighter with floating glass	1
GDLLG50W	White	Downlighter with floating glass	1

Lamp:	MR16 (50W max)
Cut-out (mm):	65mm
Ceiling Depth:	116mm
Dimensions:	Luminaire 78mm x 78mm Floating glass 85mm x 85mm



GDLLG50W

Code	Colour	Description	Qty
GDLGG50B	Brass	Downlighter with floating glass	1
GDLGG50C	Chrome	Downlighter with floating glass	1
GDLGG50W	White	Downlighter with floating glass	1

Lamp:	GU10 (50W max)
Cut-out (mm):	65mm
Ceiling Depth:	116mm
Dimensions:	Luminaire 78mm x 78mm Floating glass 85mm x 85mm



GDLLG50C



Floating glass luminaires create a pleasant diffuse effect with some upward light component.

Features:

- Square downlighter with etched glass to diffuse the light from the lamp evenly
- Complete with stirrup and covered terminal block, quick fit steel spring clips and a lamp retaining clip
- For use with max 50W MR16 dichroic lamp (not included) or mains voltage GU10 lamp (included)
- Dichroic lamps reflect heat backwards to provide a cool beam while GU10 lamps reflect heat forwards
- Suitable for commercial and domestic applications

Light | Indoor lighting

Downlighter transformers



Transformers – Performer



GTRE105

Code	Description	Qty
GTRE65	65VA electronic dimmable transformer	1
GTRE105	105VA electronic dimmable transformer	1
GTRE150	150VA electronic dimmable transformer	1
GTRE200	200VA electronic dimmable transformer	1

Dimensions:	124(W) x 40(H) x 30(D)
Weight:	85 gms
Dimensions:	124(W) x 40(H) x 30(D)
Weight:	85 gms
Dimensions:	206(W) x 56(H) x 44(D)
Weight:	270 gms
Dimensions:	206(W) x 56(H) x 44(D)
Weight:	290 gms

- Compact installer friendly design.
- For use with GET low voltage luminaires.
- 5 year guarantee.

Transformers – Performer Plus



GTRE105P

Code	Description	Qty
GTRE65P	65VA electronic dimmable transformer	1
GTRE105P	105VA electronic dimmable transformer	1
GTRE150P	150VA electronic dimmable transformer	1
GTRE200P	200VA electronic dimmable transformer	1

Dimensions:	124(W) x 40(H) x 30(D)
Weight:	85 gms
Dimensions:	124(W) x 40(H) x 30(D)
Weight:	85 gms
Dimensions:	206(W) x 56(H) x 44(D)
Weight:	280 gms
Dimensions:	206(W) x 56(H) x 44(D)
Weight:	300 gms

- Compact installer friendly design.
- For use with GET low voltage luminaires.
- Resettable thermal cut out switch.
- Power on LED indicator.
- Unique central earthing posting system.
- 10 year guarantee.

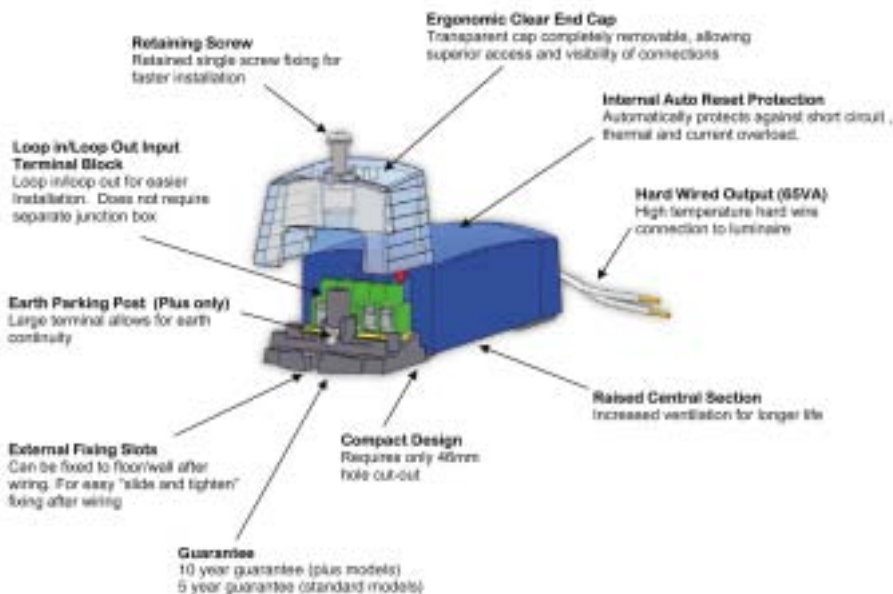

Junction box



GJBN20ASBR





Code	Description	Qty
GJBN20ASBR	59mm 20A 4 terminal junction box (designed to fit through standard cut-out)	10

Light | Indoor lighting | Downlighters

Recessed wall, ceiling and stairs







Ceiling IP54 round luminaire

Code	Description	Qty		
 GDLCRF1LB	1W LED blue	1	Lamp supplied Cut-out: 75mm diameter Mounting depth: 100mm Dimensions: 100mm diameter Requires LED driver (see LED accessories)	
 GDLCRF40G	1W LED white	1		
 GDLCRF40G	40W G9 240V round flat cover	1		Lamp: G9 halogen (not supplied) Cut-out: 75mm dia Mounting depth: 100mm Dimensions: 100mm diameter Requires LED driver (see LED accessories)
 GDLCRF50C	50W capsule 12V round flat cover	1		
GDLCRF50M	50W (max.)	1		Lamp: MR16 (not supplied) Cut-out: 75mm dia Mounting depth: 100mm Requires low voltage transformer (GET part no: GTRE65P)



Ceiling square luminaire

Code	Description	Qty	
 GDLCSF1LB	1W LED blue	1	Lamp supplied Cut-out: 77 x 77mm Mounting depth: 120mm Dimensions: 89mm x 89mm Requires LED driver (see LED accessories)
 GDLCSF50M	1W LED	1	
 GDLCSF50M	50W (max.) 12V	1	Lamp: MR16 (not supplied) Cut-out: 77 x 77mm Mounting depth: 120mm Dimensions: 89mm x 89mm Requires low voltage transformer (GET part no: GTRE65P)
 GDLCSF40G	40W 240V	1	
GDLCSF50C	50W (max.) 12V	1	Lamp: G6.35 capsule (not supplied) Cut-out: 77 x 77mm Mounting depth: 120mm Dimensions: 89mm x 89mm Requires low voltage transformer (GET part no: GTRE65P)

Features and benefits:

- Matt steel finish
- Die cast construction
- IP54 for bathroom use (round only)
- LED units in blue or white (150,000 hours life)
- Snap-fit cover plates (square units only)
- LED units feature snap-fit connectors for quick and easy installation

See page 125 for low voltage transformers.
For technical information see page 193



Contemporary recessed luminaires for walls, stairs and ceilings.

Light | Indoor lighting | Downlighters

Cover plates



Wall Square Luminaire



Code	Description	Qty
GDLWSF1LB	1W LED blue square flat cover	1
GDLWSF1LW	1W LED white square flat cover	1
GDLWSR1LB	1W LED blue square recessed cover	1
GDLWSR1LW	1W LED white square recessed cover	1

Lamp supplied
 Cut-out: Plasterboard 78mm x 72mm
 Solid wall 79mm x 115mm
 Mounting depth: 40mm
 Dimensions: 89mm x 89mm

- Requires LED driver and link cable (see LED accessories)

- Wall units supplied complete with wall mounting box



Replacement cover plates



Code	Description	Qty
GDLFCSC	Square with circles cover pattern	1
GDLFCSL	Square louvre	1
GDLFCSW	Square with window cover pattern	1
GDLFCSP	Square floating glass	1

Dimensions: 89mm x 89mm

- Interchangeable with all square wall and ceiling fittings

LED accessories



Code	Description	Qty
GDDR	LED driver – powers up to a maximum of eight individual 1W LED luminaires	1
GDLC	1.5m LED link cable Use when operating more than 1 luminaire from GDDR driver. Requires 2 cables for 2 luminaires, 3 cables for 3 luminaires, 4 cables for 4 luminaires, etc.	1

Dimensions (mm): L167 x W39 x D30



This cable is not required when operating only one luminaire.

Typical installation



Wall versions supplied complete with mounting box.



Light | Indoor Lighting

Cabinet and undershelf range

A traditional range of low voltage cabinet lighting and mains voltage striplights. Our cabinet lights are available in 3 finishes and in single or 3 piece kit formats, the kit comes complete with electronic transformer. Striplights (page 130) are available in 2 sizes with and without switch (pull and push).

New for 2007 is a range of mini batten link lights designed for under cabinet and display lighting applications. The fittings can be linked either directly or by the extension cable enabling complete flexibility.

Features and benefits

Mini batten link lighting

All mini battens can be inter connected directly or by using the link cable (supplied)

Supplied with triphosphor fluorescent tube

Available in 5 lengths

Electronic flicker free operation

Cabinet lights

Available in single or 3 piece kit

Supplied complete with G4 lamps

Electronic dimmable transformers with thermal protection supplied with kits

Luminaires supplied with removable mounting collar for surface or flush mounting

3 finishes: white, chrome and brass

Easy to fit plug and socket system

Striplights

Available in 2 sizes (221mm and 284mm)

Slimline design

With or without switch

Switched versions available with push or pull switching

Light | Indoor lighting

Mini batten link lighting



Under cupboard link lighting



Code	Description	Qty
GT4FL6W35	Mini batten link light - 6W	1
GT4FL10W35	Mini batten link light - 10W	1
GT4FL16W35	Mini batten link light - 16W	1
GT4FL20W35	Mini batten link light - 20W	1
GT4FL30W35	Mini batten link light - 30W	1
LINK500	500mm link cable	1
LINK1M	1m link cable	1

Lamp:	T4 fluorescent
Dimensions:	275mm (11")
Lamp:	T4 fluorescent
Dimensions:	400mm (16")
Lamp:	T4 fluorescent
Dimensions:	500mm (20")
Lamp:	T4 fluorescent
Dimensions:	625mm (25")
Lamp:	T4 fluorescent
Dimensions:	760mm (30")



Direct and cable link



Cable link



Direct link



Features:

- Supplied with linking cable
 - All mini battens can be interconnected directly or with link cable (supplied)
 - Electronic flicker free operation
 - Supplied with 3500K triphosphor white tube
 - Full fitting instructions and fixing kit included
- BS EN 60598

Replacement lamps



Code	Watts	Volts	Qty
T4FL6W35	6W	230V	10
T4FL10W35	10W	230V	10
T4FL16W35	16W	230V	10
T4FL20W35	20W	230V	10
T4FL30W35	30W	230V	10

Colour: White 35	Length: 11" 275mm
Colour: White 35	Length: 16" 400mm
Colour: White 35	Length: 20" 500mm
Colour: White 35	Length: 25" 625mm
Colour: White 35	Length: 30" 760mm

Light | Indoor lighting

Cabinet and undershelf range



Low voltage cabinet lights (lamp included)



GDLLC20B – Flush Mounted



GDLLC20C – Surface Mounted

Code	Description	Qty
GDLLC20B	20W Brass	1
GDLLC20C	20W Chrome	1
GDLLC20W	20W White	1

Lamps: G4 halogen capsule
 Dimensions: 70mm diameter
 28mm depth (surface mounted)
 Ceiling depth: 20mm (flush mounted)
 Weight: 187gms
 Features:
 • Frosted glass lens
 • Single lights have 1.5m cable (no connectors)
 • Removable mounting collar for surface or flush mounting
 BS EN 60598-1

Low voltage cabinet light kits (lamps included)



GDLLCK320B

Code	Description	Qty
GDLLCK320B	20W Brass kit	1
GDLLCK320C	20W Chrome kit	1
GDLLCK320W	20W White kit	1

Kit contains 3 x 20W light fittings complete with G4 halogen capsule lamps and electronic transformer
 Features:
 • Easy to fit plug and socket system
 • Dimmable electronic transformer includes overload and output short circuit protection

221mm & 284mm striplights (lamp required)



Code	Description	Qty
GSTLIT1	60W 221mm Unswitched	6
GSTLIT1PS	60W 221mm Push switch	6
GSTLIT1PU	60W 221mm Pull switch	6
GSTLIT4	60W 284mm Unswitched	6
GSTLIT4PS	60W 284mm Push switch	6
GSTLIT4PU	60W 284mm Pull switch	6

Lamps: Striplights
 Striplights utilise linear incandescent lamps and are perfect for providing complementary lighting. They are normally used under cabinets or cupboards in kitchens.
 Features:
 • Suitable for wall/ceiling mounting undershelves in kitchens etc
 • Slimline design

Shaver lights (lamp included)



GSHVLIT

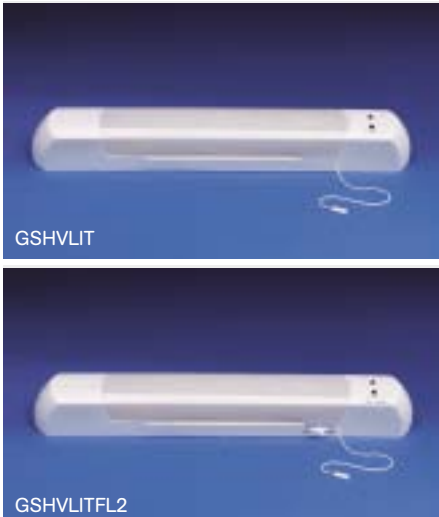

GSHVLITFL2

Code	Description	Qty
GSHVLIT	60W Tungsten single voltage 230V output	1
GSHVLIT2	60W Tungsten dual voltage 115/230V output	1
GSHVLITFL	11W Fluorescent single voltage 230V output	1
GSHVLITFL2	11W Fluorescent dual voltage 115/230V output	1

A stylish range of four shaver light units are designed to complement even the most modern of bathrooms, the soft lines ensure compatibility with any décor whilst limiting dust and dirt collection. Even light dissipation is achieved through the opal diffuser whilst also providing safe disconnection of lamp contacts (when removed for easy replacement of lamps – 60W variants only).

Careful attention has been paid for fast and easy installation including a removable back plate and terminal access for wiring even after the unit has been fixed to the wall. The range is fully certified to all of the relevant safety standards.

Lamps: Striplights
 Dimensions: 500mm(L) x 60mm(W) x 70mm(H)
 Features:
 • Stylish modern design blends with any décor
 • Opal diffuser for a softer light
 • Fitted with Earth looping terminal
 • Supplied with loose back plate for faster fixing
 • 60W fittings provide safe disconnection of lamp contact once the diffuser is removed
 • Easy connection method
 • Suitable for use in bathrooms Zone 3 (see Zone information page 117)
 • Manufactured in flame retardant polycarbonate
 • IP20
 Specifications
 • Maximum lamp rating 60W
 • Supplied pre-fitted with 284mm striplight or 11W CFL fluorescent lamp
 • Manufactured in flame retardant polycarbonate
 • Compatible with UK, Europe, Australia and USA regulations
 • Complies with BS EN 60598-2-1

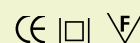

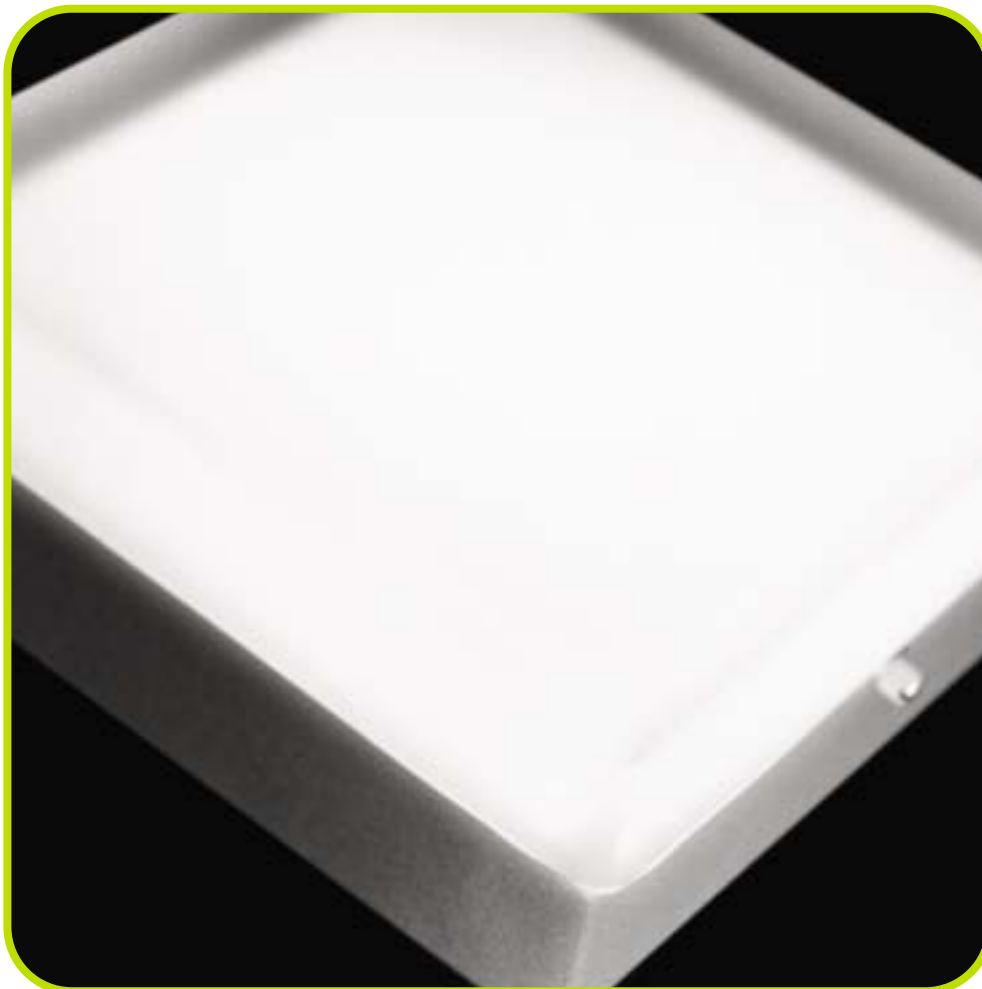

Light | Indoor Lighting

Bathroom range

Our range of bathroom fittings is designed to provide sophisticated light solutions while offering complete safety within this wet environment. Traditionally a difficult area to illuminate sympathetically, the G9 drum range offers stylish design options using etched glass diffusers to distribute light evenly. All luminaires are IP44 rated and comply with electrical and safety standards.

Features and benefits

40W G9 mains voltage halogen lamps (supplied with fittings)

Etched glass diffusers to distribute light evenly

Other lamp options include 25W SES candles

IP44 rated (suitable for use in bathrooms)

Round, square and flush fittings

Suitable for wall or ceiling mounting

This section features:

Decorative wall and ceiling luminaires IP44: G9 halogen and candle lamps

Shaver lights: 11W compact and 60W tungsten

Shower downlights IP54: Low voltage and GU10

Page 132

Page 133

Page 134

Light | Indoor lighting | Bathroom range

Decorative Wall and ceiling IP44



Decorative bathroom lights

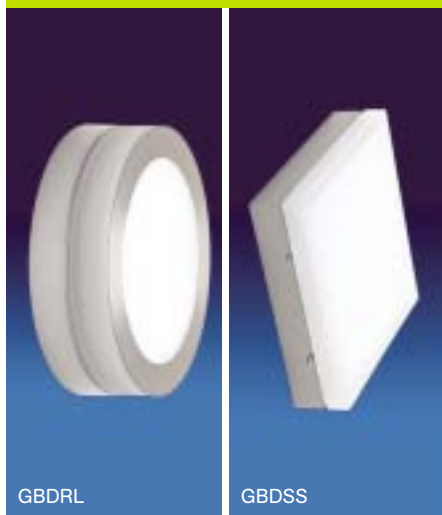

GBDRL

GBDSS



GBDRF

Code	Description	Qty
GBDRL	Round large	1
GBDRS	Round small	1
GBDSS	Square small light	1
GBDSL	Square large light	1
GBDRF	Flushlight	1

Lamp: G9 60W (included)
Dimensions: 230 dia x 68mm

Lamp: G9 25W (included)
Dimensions: 150 dia x 68mm

Lamp: G9 40W (included)
Dimensions: 150 x 150 x 60mm

Lamp: G9 60W (included)
Dimensions: 230 x 230 x 60mm

Lamps: 2 x 40W candle SES (lamp required)
Dimensions: 340 dia x 40mm

• G9 mains voltage halogen lamps supplied with fitting

☐ Double insulated

Decorative bathroom wall lights



GBDWB

Code	Description	Qty
GBDWB	Wall light	1

Lamps: 40W candle SES (lamp required)
Dimensions: 265 x 155 x 89mm

This range has been designed specifically for the bathroom. The range includes square and circular options plus a series of modern wall mounted designs.

In particular the GBDGP distributes light horizontally and a pair of these mounted either side of a mirror provides a great effect.

Features:

- All options are surface mounted
- Luminaires have a variety of finishes and use etched glass diffusers to distribute light evenly
- Other lamp options include 25W and 40W SES candles
- IP44
- Suitable for use in bathrooms in zone 2 or 3

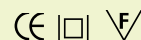

Light | Indoor lighting | Bathroom range

Shaver lights



Shaver lights (lamp included)

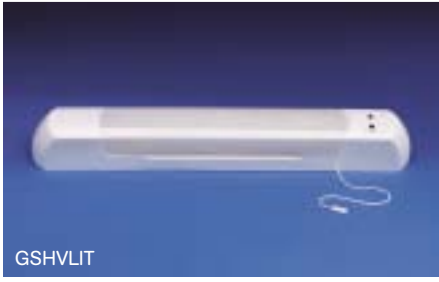

GSHVLIT

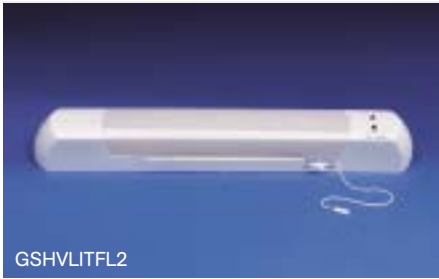

GSHVLITFL2

Code	Description	Qty
GSHVLIT	60W Tungsten single voltage 230V output	1
GSHVLIT2	60W Tungsten dual voltage 115/230V output	1
GSHVLITFL	11W Fluorescent single voltage 230V output	1
GSHVLITFL2	11W Fluorescent dual voltage 115/230V output	1

Lamps: 60W Striplights or 11W CFL fluorescent (lamps included)

Dimensions:
500mm(L) x 60mm(W) x 70mm(H)



A stylish range of four shaver light units are designed to complement even the most modern of bathrooms, the soft lines ensure compatibility with any décor whilst limiting dust and dirt collection. Even light dissipation is achieved through the opal diffuser whilst also providing safe disconnection of lamp contacts (when removed for easy replacement of lamps – 60W variants only).

Careful attention has been paid for fast and easy installation including a removable back plate and terminal access for wiring even after the unit has been fixed to the wall. The range is fully certified to all of the relevant safety standards.

Features

- Stylish modern design blends with any décor
- Opal diffuser for a softer light
- Fitted with Earth looping terminal
- Supplied with loose back plate for faster fixing
- 60W fittings provide safe disconnection of lamp contact once the diffuser is removed
- Easy connection method
- Suitable for use in bathrooms Zone 3 (see Zone information below)
- Manufactured in flame retardant polycarbonate
- IP20

Specifications

- Maximum lamp rating 60W
- Supplied pre-fitted with 284mm striplight or 11W CFL fluorescent lamp
- Manufactured in flame retardant polycarbonate
- Compatible with UK, Europe, Australia and USA regulations
- Complies with BS EN 60598-2-1

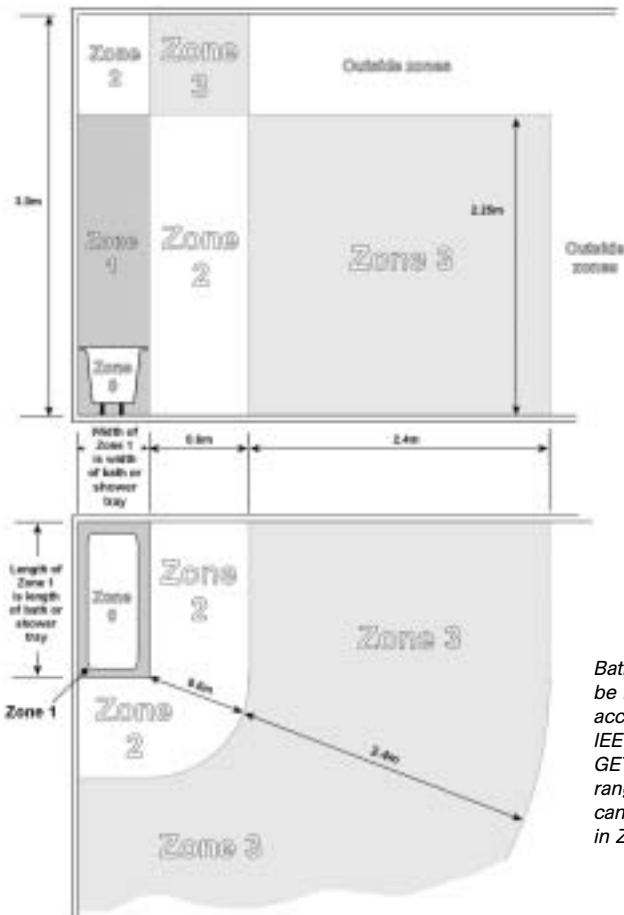

Bathroom lights must be installed in accordance with IEE regulations, GET's shaver light range is IP20 and can be installed in Zone 3.

For lighting installed in Zone 1, all luminaires must be at least IPX4, or IPX5 if water jets are used for cleaning. Mains voltage luminaires can only be used if the circuit is protected by a Residual Current Device having a rated residual operating current not exceeding 30mA. SELV (12V ac) luminaires can be used without RCD protection. The SELV source (transformer) must be located outside Zones 0, 1 and 2, e.g. in the ceiling void.

Shaver lights have concealed / protected dual voltage shutter socket



Light | Indoor lighting | Downlighters

IP54 Shower lights – low voltage and mains halogen



Low voltage MR16 halogen shower lights (lamp required)



Code	Description	Qty
GDLLS50B	50W 12V MR16 brass	1
GDLLS50C	50W 12V MR16 chrome	1
GDLLS50W	50W 12V MR16 white	1
GDLLS50SS	50W 12V MR16 stainless steel	1
GDLLS50BN	50W 12V MR16 black nickel	1
GDLLS50BS	50W 12V MR16 satin brass	1
GDLLS50PN	50W 12V MR16 pearl nickel	1

Lamp: MR16 (50W max)
 Cut-out (mm): 72.5mm
 Ceiling Depth: 100mm
 Diameter: 83mm

Suitable for use in zone1

Mains voltage GU10 halogen shower lights (lamp included)



Code	Description	Qty
GDLGS50B	50W 240V GU10 brass	1
GDLGS50C	50W 240V GU10 chrome	1
GDLGS50W	50W 240V GU10 white	1
GDLGS50SS	50W 240V GU10 stainless steel	1
GDLGS50BN	50W 240V GU10 black nickel	1
GDLGS50BS	50W 240V GU10 satin brass	1
GDLGS50PN	50W 240V GU10 pearl nickel	1

Lamp: MR16 (50W max)
 Cut-out (mm): 72.5mm
 Ceiling Depth: 100mm
 Diameter: 83mm

Features

- Suitable for use in bathrooms and shower cubicles
- Clear glass diffuser
- Also suitable for exterior use (IP54 rated), for example on porches
- Die cast construction c/w stirrup and enclosed terminal block
- For use with max 50W MR16 dichroic lamp (not included) or mains voltage GU10 lamp (included)



For lighting installed in Zone 1, all luminaires must be at least IPX4, or IPX5 if water jets are used for cleaning. Mains voltage luminaires can only be used if the circuit is protected by a Residual Current Device having a rated residual operating current not exceeding 30mA. SELV (12v ac) luminaires can be used without RCD protection. The SELV source (transformer) must be located outside Zones 0, 1 and 2, e.g. in the ceiling void.

Bathroom lights must be installed in accordance with IEE regulations, GET's shower range is IP54 rated and can be installed in zones 1, 2 or 3 as specified above (see page 133).

See page 160-161 for lamps.

See also page 126 for IP54 matt steel finish downlights in LED, G9 and low voltage versions.

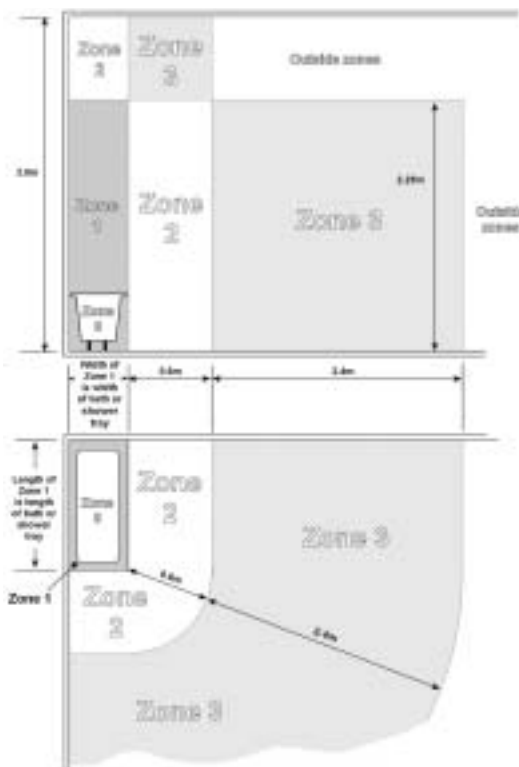

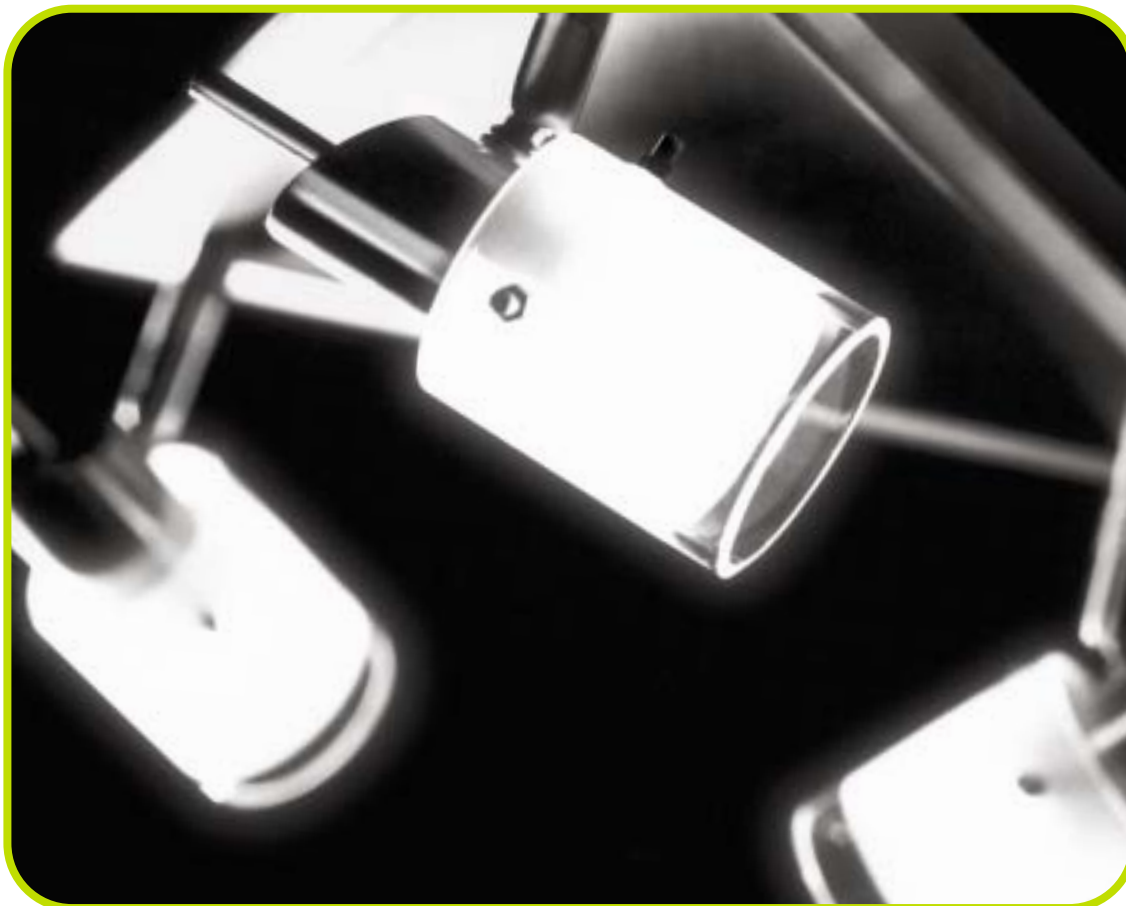

Light | Indoor lighting | Decorative range

Our new range of spotlights use G9 and GU10 mains voltage halogen lamps in three modern, highly stylish design styles: White circo, Deco and Clear circo. The key benefit of G9 lamp technology means the light head can be smaller to enhance directional control.

The wide choice of decorative fittings – from single spotlight to triple quad ceiling plates – make these ideal for domestic and display lighting applications.

Features and benefits

Fully adjustable heads provide directional light

Wide choice of stylish fittings:

- Single spotlight
- Double bar
- Triple and quad bar and ceiling plates

Three modern styles combining glass and metal

Suitable for domestic and display lighting applications

40W G9 mains voltage halogen lamps supplied with fittings

GU10 lamps supplied with fittings

Styles

White circo: pearl nickel with white circular diffusers

Deco circo: satin nickel clear cubic diffusers

Clear circo: stainless steel with circular diffusers

Light | Indoor lighting | Decorative range

GU10 spotlights



Single GU10 spotlights (lamp included)



GCSG1P50SGB

Code	Description	Qty
GCSG1P50C	Single Spot – Polished chrome	1

Lamps:	GU10
Dimensions:	80mm diameter
Weight:	0.35kg

Triple plate GU10 spotlights (lamp included)



GCSG3P50SGB

Code	Description	Qty
GCSG3P50C	Triple Plate – Polished chrome	1
GCSG3P50SGB	Triple Plate – Satin Nickel with blue glass	1

Lamps:	GU10
Dimensions:	185mm diameter
Weight:	1.27kg

Triple straight bar GU10 spotlights (lamp included)



GCSG3B50C

Code	Description	Qty
GCSG3B50C	Triple Straight Bar – Polished chrome	1
GCSG3W50SGW	Triple Wave Bar – Satin nickel with white glass	1
GCSG3W50SGB	Triple Wave Bar – Satin nickel with blue glass	1

Lamps:	GU10
Dimensions:	100mm centre plate 700mm length
Weight:	1.39kg

Quad wave bar spotlights (lamp included)



GCSG4W50SGW

Code	Description	Qty
GCSG4W50C	Quad Wave Bar – Polished chrome	1
GCSG4W50SGW	Quad Wave Bar – Satin nickel with white glass	1
GCSG4W50SGB	Quad Wave Bar – Satin nickel with blue glass	1

Lamps:	GU10
Dimensions:	100mm centre plate 820mm length
Weight:	1.79kg

Our GU10 spotlights provide a stylish, modern effect in any room. The products are offered in 3 different finishes and are available in four configurations to ensure there is a fitting to satisfy any installation.

The fittings are supplied complete with 50W GU10 lamps (replacement code HD50WGU10) and full instructions and fixing kit.

Features

- Fully adjustable heads
- Choice of single, triple or quad fittings
- Bar and plate designs
- Easy to change lamps
- Supplied complete with 50W GU10 lamps
- Manufactured to BS EN 60598-2-1



Satin nickel with frosted blue glass



Satin nickel with frosted white glass



Polished chrome

RANGE UNDER REVIEW - PLEASE CHECK AVAILABILITY

Light | Indoor lighting | Decorative range

GU10 flat plate spotlights



GU10 flat plate



GCSGF50BN



GCSGF50CB

Code	Description	Qty
GCSGF50B	GU10 flat plate – Brass	1
GCSGF50C	GU10 flat plate – Chrome	1
GCSGF50W	GU10 flat plate – White	1
GCSGF50BN	GU10 flat plate – Black nickel	1
GCSGF50PN	GU10 flat plate – Pearl nickel	1
GCSGF50CB	GU10 flat plate – Brushed chrome	1
GCSGF50BB	GU10 flat plate – Brushed brass	1

Lamps: GU10 50W max (lamps included)

Dimensions: 100mm diameter

Ceiling depth: 75mm

Cut-out: 80mm

A compact and robust range of mains voltage GU10 spotlights for ceiling mounting. The Flat Plate range offers an ideal retrofit for downlighters by utilising existing cut outs. In most cases this allows for a fast upgrade from low voltage to mains voltage GU10 and provides a modern sleek fitting in a variety of finishes.

Features:

- Fully adjustable heads provides directional light (60° max) and no dark ceilings
- Flat plate recesses up to the ceiling and is secured with spring clips
- Suitable for retail stores, DIY and display lighting applications
- Drop measurement 125mm



Compact fluorescent downlighters (lamp required)



Fixed glass



Floating glass

Code	Description	Qty
Fixed glass cover		
GD LCS126G	Single 26W with fixed glass	1
GD LCS226G	Twin 26W with fixed glass	1
Etched floating glass cover		
GD LCS126FG	Single 26W with floating glass	1
GD LCS226FG	Twin 26W with floating glass	1

Lamps: CFL fluorescent

Cut out: 180mm

Ceiling depth: 100mm

Dimensions: 210mm diameter

Weight: 1.5kg

A highly efficient low energy downlighter using horizontally mounted compact fluorescent lamps. Available in two options, either fixed or a floating glass. The floating glass helps to reflect a little of the light upwards to accent the ceiling and hide the lamp

Features:

- Electro brightened aluminium reflector
- Pre-wired separate control gear box with easy access for termination
- Switch start control gear (LPF)
- Horizontal lamp position
- Use with CFL fluorescent lamp – see page 163



Fitting c/w control gear



Light | Indoor lighting | Decorative range

G9 spotlights



G9 spot lights (lamp included)

White circo style



GCS9R2PSNF

Code	Description	Qty	Lamp	Weight	Dimensions (L x W x H)
White circo style (pearl nickel with white diffusers)					
GCS9R1PSNFS	1 x G9 Spotlight rectangular base with switch	1	G9	0.5kg	170 x 70 x 100mm (wall mounted)
GCS9R2PSNF	2 x G9 Spotlight rectangular base	1	G9	0.8kg	150 x 150 x 340mm
GCS9R3BSNF	3 x G9 Spotlight rectangular base	1	G9	0.9kg	540 x 50 x 170mm
GCS9R3PSNF	3 x G9 Spotlight round base	1	G9	1.6kg	220 dia. x 170mm

Deco style



GCS9C1PSNC

Deco style (satin nickel with clear cubic diffusers)					
GCS9C1PSNC	1 x G9 Spotlight square base with switch	1	G9	0.5kg	120 x 60 x 100mm (wall mounted)
GCS9C2BSNC	2 x G9 Spotlight bar	1	G9	0.6kg	360 x 100 x 170mm
GCS9C3BSNC	3 x G9 Spotlight bar	1	G9	0.7kg	630 x 100 x 143mm
GCS9C4PSNC	4 x G9 Spotlight square base	1	G9	1.6kg	230 x 230 x 156mm

Clear circo style



GCS9GB3PSNF

Clear circo style (stainless steel with clear circo diffusers)					
GCS9C4BSNC	4 x G9 Spotlight bar	1	G9	2.2kg	890 x 120 x 160mm
GCS9GB2BSNF	2 x G9 Spotlight glass rectangle plate	1	G9	0.7kg	400 x 90 x 170mm
GCS9GB3PSNF	3 x G9 Spotlight glass triangle plate	1	G9	1.6kg	300 x 300 x 170mm
GCS9GB3BSNF	3 x G9 Spotlight glass rectangle plate	1	G9	1.6kg	600 x 90 x 170mm
GCS9GB4PSNF	4 x G9 Spotlight glass square plate	1	G9	1.7kg	260 x 260 x 170mm

A new range of spotlights that uses the 40W G9 mains voltage Halogen lamp in three modern design styles. The G9 lamp technology means a smaller light head can be used to provide better directional control.

Features:

- Fully adjustable heads provides directional light
- 40W G9 mains voltage halogen lamps supplied with the fitting
- Available in single spotlight, double bar, triple bar and triple and quad ceiling plates the range offers a wide choice of fittings
- Three styles of fitting are available using a mixture of glass and metal
- Suitable for both domestic use and display lighting applications



Single fittings supplied with switch

Note

If using a dimmer take the total wattage of the lights and multiply by 2. Treat this as the rated load (wattage) for the dimmer e.g. if using product with 3 x 40W lamps = 120W multiply this by 2 = 240W. The dimmer should therefore be capable of handling a load of 240W.

RANGE UNDER REVIEW - PLEASE CHECK AVAILABILITY

Light | Indoor lighting | Decorative range

Ceiling flushlight and uplighter



60W flush lights (lamp required)



GFLC60B

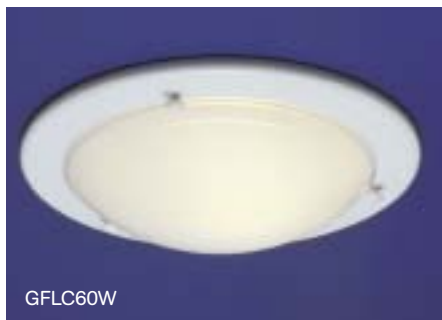

GFLC60W

Code	Description	Qty
GFLC60B	Brass effect ceiling light	1
GFLC60C	Chrome ceiling light	1
GFLC60W	White ceiling light	1

Flush lights are ideal ceiling fixtures suitable for bathrooms, offices and corridors and are available in Brass, Chrome and White.

Lamps: 60W ES
 Dimensions: 310mm diameter (max drop from ceiling 55mm)
 Weight: 0.117kg

Features:

- Suitable for wall/ceiling mounting
- Slimline design
- 60W ES fitting suitable for use with GLS/Golfball/Candle lamps
- Decorative opal glass diffuser for even light dissipation



40W mains voltage uplighter (lamp required)



GBDWO

Code	Description	Qty
GBDWO	Candle uplighter in stainless steel finish	1

This open uplighter uses a single 40W SES candle lamp and is ideal for domestic and commercial use.

Lamps: 1 x 40W SES candle
 Dimensions: (H x W x D)
 65mm x 275mm x 80mm

Weight: 0.4kg

Features:

- Wall mount only

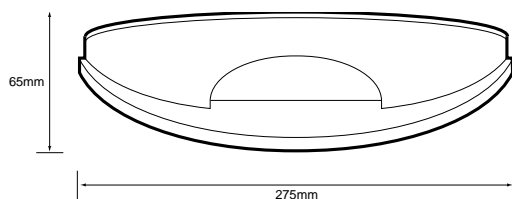

See page 159 for lamps.

RANGE UNDER REVIEW - PLEASE CHECK AVAILABILITY



Light | Indoor lighting

Fluorescent battens and diffusers

The range of fluorescent battens from GET is the ideal choice for commercial, industrial or domestic installations – combining quality, style, ease of installation and value for money.

- High impact moulded lamp holder end cap assemblies
- Powder coated steel casing for durability and enhanced rigidity
- High temperature cable for electrical safety
- High quality starter for reliability and long life
- Large terminal connectors and cable entry for ease of wiring
- Approved ballasts for long operational life and low noise emissions
- Easy fit cover tray, simply turn the twist lock at each end of the batten for fuss free installation and maintenance without the use of a tool
- High quality long life power factor correction capacitor (HPF versions)

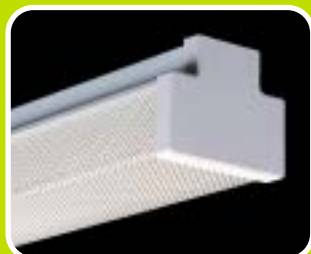

Slimline range of battens can be mounted direct to ceiling, walls or suspended by chain or conduit



The innovative design of both the round and square diffuser kits allow for installation on existing GET battens without the need to either remove or rewire the fitting



Additional accessories include square and round prismatic diffusers and reflectors



High frequency batten options for energy efficiency



Light | Indoor lighting

Fluorescent battens and diffusers



Bare batten - low power factor (complete with lamp)



Code	Description	Wattage	Qty
LP118LPF	650mm (2ft) single	18W	1
LP218LPF	650mm (2ft) twin	18W	1
LP136LPF	1225mm (4ft) single	36W	1
LP236LPF	1225mm (4ft) twin	36W	1
LP158LPF	1525mm (5ft) single	58W	1
LP258LPF	1525mm (5ft) twin	58W	1
LP170LPF	1790mm (6ft) single	70W	1
LP270LPF	1790mm (6ft) twin	70W	1

- Supplied with white 35 T8 fluorescent tubes
- Durable slim line steel construction
- Width of base 54mm
- Simple 90° turn twist toggles allow for easy access to the gear tray without the need for tools
- Large terminal blocks for fast and easy cable connection

Bare batten - high power factor (complete with lamp)



Code	Description	Wattage	Qty
LP118HPF	650mm (2ft) single	18W	1
LP218HPF	650mm (2ft) twin	18W	1
LP136HPF	1225mm (4ft) single	36W	1
LP236HPF	1225mm (4ft) twin	36W	1
LP158HPF	1525mm (5ft) single	58W	1
LP258HPF	1525mm (5ft) twin	58W	1
LP170HPF	1790mm (6ft) single	70W	1
LP270HPF	1790mm (6ft) twin	70W	1

- High quality epoxy powder coated finish
- UV stabilised, non colouring, high impact end cap assemblies
- End cap knockouts - no special tool or end cap drilling required
- Low and high power factor battens for general use
- Emergency available to order (high power factor only)

Volts: 240V



Bare batten - high frequency (complete with lamp)



Code	Description	Wattage	Qty
LP136HF	1225mm (4ft) single	36W	1
LP236HF	1225mm (4ft) twin	36W	1
LP158HF	1525mm (5ft) single	58W	1
LP258HF	1525mm (5ft) twin	58W	1
LP170HF	1790mm (6ft) single	70W	1
LP270HF	1790mm (6ft) twin	70W	1

- No visible flicker
- No audible noise
- First time starting
- Reduced running cost (typically 25% energy savings)
- Lower weight
- Easier maintenance
- Further power factor improvement
- up to 5% increase in lumen performance
- Longer lamp life
- Emergency available to order

Volts: 240V



Square diffusers

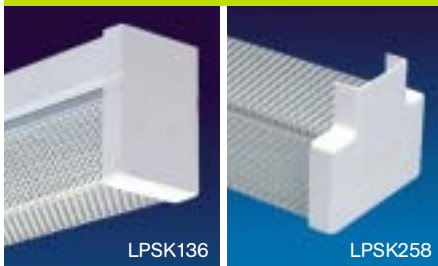

Code	Description	Qty
LPSK118	650mm (2ft) single	2
LPSK218	650mm (2ft) twin	2
LPSK136	1225mm (4ft) single	2
LPSK236	1225mm (4ft) twin	2
LPSK158	1525mm (5ft) single	2
LPSK258	1525mm (5ft) twin	2
LPSK170	1790mm (6ft) single	2
LPSK270	1790mm (6ft) twin	2

- Prismatic acrylic diffuser for low glare soft light
- No special tooling required for installation and maintenance
- For use with GET battens
- Includes lipped cover tray for snug fit which minimises insect ingress and reduces routine cleaning
- UV stabilised high impact end caps which do not allow light to penetrate

Round diffusers



Code	Description	Qty
LPDK118	650mm (2ft) single	2
LPDK218	650mm (2ft) twin	2
LPDK136	1225mm (4ft) single	2
LPDK236	1225mm (4ft) twin	2
LPDK158	1525mm (5ft) single	2
LPDK258	1525mm (5ft) twin	2

- Prismatic acrylic diffuser for low glare soft light
- No special tooling required for installation and maintenance
- For use with GET battens
- Provides lower light loss than conventional square diffusers
- UV stabilised high impact end caps which do not allow light to penetrate

Metal reflectors



Code	Description	Qty
LPRK36W	1225mm (4ft) single	4
LPRK58W	1525mm (5ft) single	4
LPRK70W	1790mm (6ft) single	4

- Suitable for single and double tube battens
- Powder coated steel for a smooth durable finish
- Broad lighting distribution
- For use with GET battens



Our outstanding range of amenity luminaires has been designed to encompass durability with good design together with excellent lighting performance.

Our products have been designed with the contractor in mind and are quick and easy to install.

A unique feature of the GET range – our drum range have a surface wiring facility as well as a hinged demountable gear tray.

The range is complemented with the introduction of high frequency models.

Light | Outdoor lighting | Amenity range

Features and benefits		Specification	
Range of ten CFL energy saving compact fluorescent fittings complete with lamps	Low level 20mm conduit entries for easy installation	IP65 rated	High quality weather resistant neoprene sealing gasket
Wall and ceiling mounting options	Unique surface wiring facility	Black and white base with four screws for improved sealing and security	Opal or Prismatic diffusers
High IP65 rating for indoor and outdoor use	Compact fluorescent lamp included with fitting for low installation and running costs	BESA box mounting	Voltage 240V
Tough UV stabilised polycarbonate body for vandal resistance	Suitable for pedestrian corridors, stairwells, subways and general amenity / security areas		Emergency options available to special order
Hinged, demountable gear tray for easy wiring	Emergency drums have an integral 3 hour battery back up		F marked
		Amenity ranges	Class 1
		Drum luminaires	Page 143
		Bukheads and bricklights,	Page 144
		Floodlights and PIRs	Page 144

Light | Outdoor lighting | Amenity range

Drum range – IP65



Compact fluorescent drums – switch start (2 pin lamp included)



GDFR28WWO



GDFS28WWP



GDFRS16WBO

Code	Description	Qty
White base		
GDFRS16WWO	16W round drum	1
GDFRS16WWP	16W round drum	1
GDFR16WWO	16W large round drum	1
GDFR16WWP	16W large round drum	1
GDFR28WWO	28W large round drum	1
GDFR28WWP	28W large round drum	1
GDFS16WWO	16W large square drum	1
GDFS16WWP	16W large square drum	1
GDFS28WWO	28W large square drum	1
GDFS28WWP	28W large square drum	1

Code	Description	Qty
Black base		
GDFRS16WBO	16W round drum	1
GDFRS16WBP	16W round drum	1
GDFR16WBO	16W large round drum	1
GDFR16WBP	16W large round drum	1
GDFR28WBO	28W large round drum	1
GDFR28WBP	28W large round drum	1
GDFS16WBO	16W large square drum	1
GDFS16WBP	16W large square drum	1
GDFS28WBO	28W large square drum	1
GDFS28WBP	28W large square drum	1

Lamp: 2 pin compact double D	
Opal diffuser	255mm diameter
Prismatic diffuser	255mm diameter
Opal diffuser	285mm diameter
Prismatic diffuser	285mm diameter
Opal diffuser	285mm diameter
Prismatic diffuser	285mm diameter
Opal diffuser	255 x 255mm
Prismatic diffuser	255 x 255mm
Opal diffuser	255 x 255mm
Prismatic diffuser	255 x 255mm



Emergency compact fluorescent drums with integral battery back-up – high frequency (4 pin lamp included)



GDFR28WWOE



GDFS28WWOE



GDFR16WBOE

Code	Description	Qty
White base		
GDFR16WWOE	16W large round drum	1
GDFR16WWPE	16W large round drum	1
GDFR28WWOE	28W large round drum	1
GDFR28WWPE	28W large round drum	1
GDFS28WWOE	28W large square drum	1
GDFS28WWPE	28W large square drum	1

Code	Description	Qty
Black base		
GDFR16WBOE	16W large round drum	1
GDFR16WBPE	16W large round drum	1
GDFR28WBOE	28W large round drum	1
GDFR28WBPE	28W large round drum	1
GDFS28WBOE	28W large square drum	1
GDFS28WBPE	28W large square drum	1

Lamp: 4 pin compact double D	
Opal diffuser	285mm diameter
Prismatic diffuser	285mm diameter
Opal diffuser	285mm diameter
Prismatic diffuser	285mm diameter
Opal diffuser	255 x 255mm
Prismatic diffuser	255 x 255mm



Features:

- Vandal resistant all-polycarbonate construction
- Hinged gear-tray for quick easy installation
- Unique easy-seal surface wiring facility
- Low-level positioned 20mm conduit entries – no conduit bending needed
- IP65 for outdoor and indoor use (including bathroom Zone 1)
- Four screw positive cover fixing to maintain IP65 integrity
- Supplied complete with 16 and 28W lamps (colour 3500K)
- BESA box fitting facility
- F marked

Emergency Luminaires:

- 3 hour self contained maintained
- 4 pin 16 and 28W 3500K lamp included

Light | Outdoor lighting | Amenity range

Bulkheads, bricklights & floodlighting



Bulkheads (lamp required)



GBH60BC



GBH100BR

Code	Description	Qty
GBH100BC	100W with clear diffuser	1
GBH100BR	100W with red diffuser	1
GBH29C	2 x 9W CFL with clear diffuser	1
GBH29CP	2 x 9W CFL with photocell and clear diffuser	1
GBH60BC	60W economy with clear diffuser	1
GBH60BCPC	60W bulkhead with cover	12

Bulkheads are a tough reliable solution to provide light for safety and security. They come with a choice of GLS and Energy Saving lamp options and also have a unit with a photocell that illuminates at a preset light level.

Lamps: BC GLS or 9W CFL energy saving

Features:

- Choice of GLS or energy saving options
- IP65
- Manufactured from die-cast aluminium
- Powder coated paint finish for extra durability
- Corrosion resistant
- Tough UV stabilised polycarbonate cover
- Choice of 20mm knockouts for cable and/or conduit entry
- Suitable for use in exterior application such as walkways and paths
- Can also use energy saving lamps (see page 163)



Photocell



GPC500C



GPC500CK

Code	Description	Qty
GPC500C	Clear electronic photocell	
GPC500CK	Clear electronic photocell kit	

Photocell kit comprises photocell head, mounting bracket and fixings.

- Electromagnetic relay
- Load: 2 x 250W HPS typical
- Max capacity: 5A/60µf
- On/off levels: 70/105 Lux (1:1.5 + VE)
- IP rating: IP65

BS 5972



40W Bricklights (lamp required)



GBL40LB

Code	Description	Qty
GBL40LB	40W louvered black	1
GBL40PB	40W plain black	1

Bricklights are a great solution to recess fittings flush to the wall for added security. The louvered option is very tough and provides a degree of vandal resistance and can be used to provide good low level lighting when mounted near paths, driveways and car park entrances.

Lamps: Decorative round, candle or energy saving

Features:

- IP44 rated
- Manufactured from die-cast aluminium
- Powder coated paint finish for extra durability
- Corrosion resistant
- Suitable for lighting paths & driveways
- Suitable for use in exterior application
- Can also use energy saving lamps (see page 163)



Floodlighting and PIRs (lamp required unless stated)



GPIRTWB



EXPIR

Code	Description	Qty
P/MINIV	150W vertical mini PIR TH floodlight c/w 150W lamp	1
GXPIRFD	500W professional 180° PIR floodlight c/w 500W lamp	1
EXPIR	500W independent PIR unit	1
MINI/FLDV	150W compact enclosed TH floodlight	1
GPIRTWB	Twin 120W PAR 38 floodlight with PIR	1

Lamps: Linear tungsten, halogen & PAR 38

- BS 4533 & BS EN 60730
- Can also use energy saving lamps (see page 163)

See page 148 for lamps.

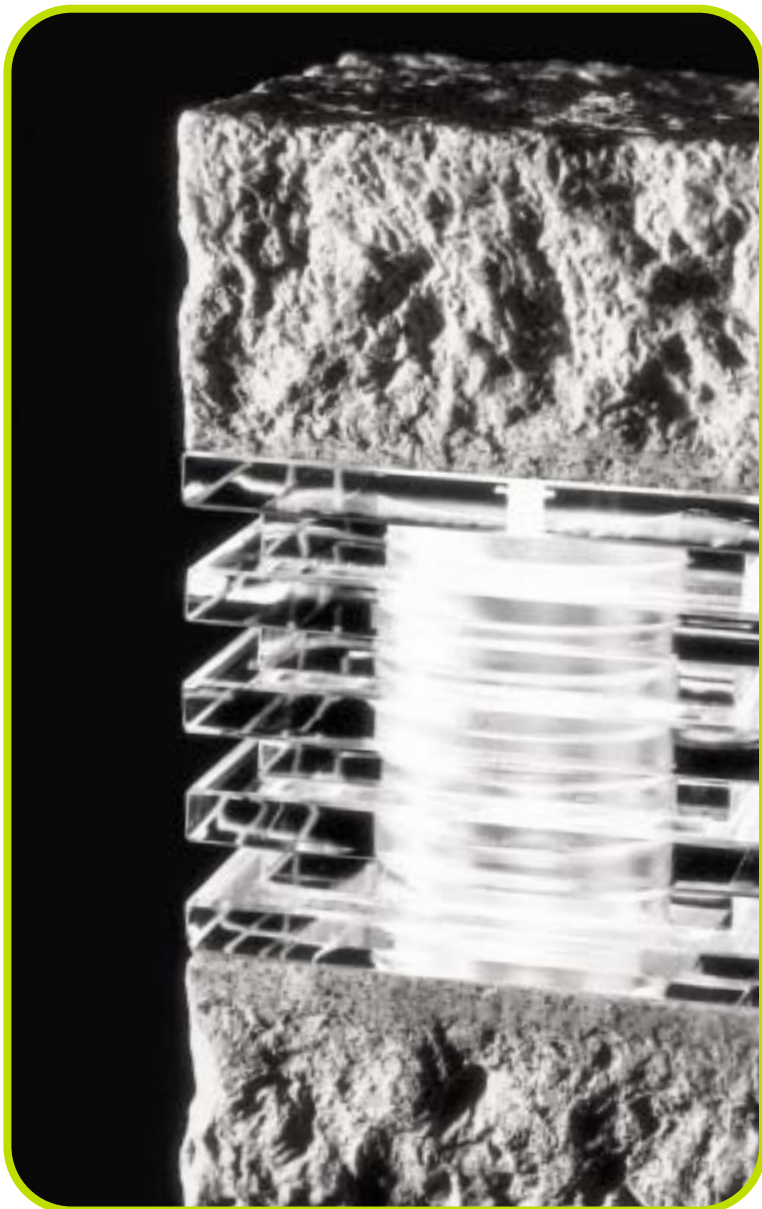

Our range of low voltage stone effect bollards and postlights with their distinct clear white light are ideal for sign-posting walkways and drives. They not only look good but are also extremely cost effective to run.

Low voltage options extend to stainless steel postlights and pagodas to add that sophisticated touch within our ever expanding range. We guarantee that whether you want a more traditional or modern fitting there are styles and finishes to suit everyone.

Light | Outdoor lighting | Low voltage

Styles available

Stone effect bollards and postlights

Die-cast cap lights and stormglass postlights

Halo postlights and Japanese lantern pagodas

Die-cast bollards

Stainless steel pagodas and postlights:

Fitted with 0.5m of SPT-1 cable

Both single units and kits are available

Suitable for decking, drives, pathways and walls

Each fitting complete with **EZClick** connector

3 year guarantee



Light | Outdoor lighting

EZClick low voltage lighting system



EZClick accessories

Step by step guide

The EZClick low voltage lighting system from GET is as simple as it sounds. No confusing wiring to be done at all. Simply connect the fittings to the low voltage cable with special connector blocks and plug in the transformer.

Step 1: Plan your design

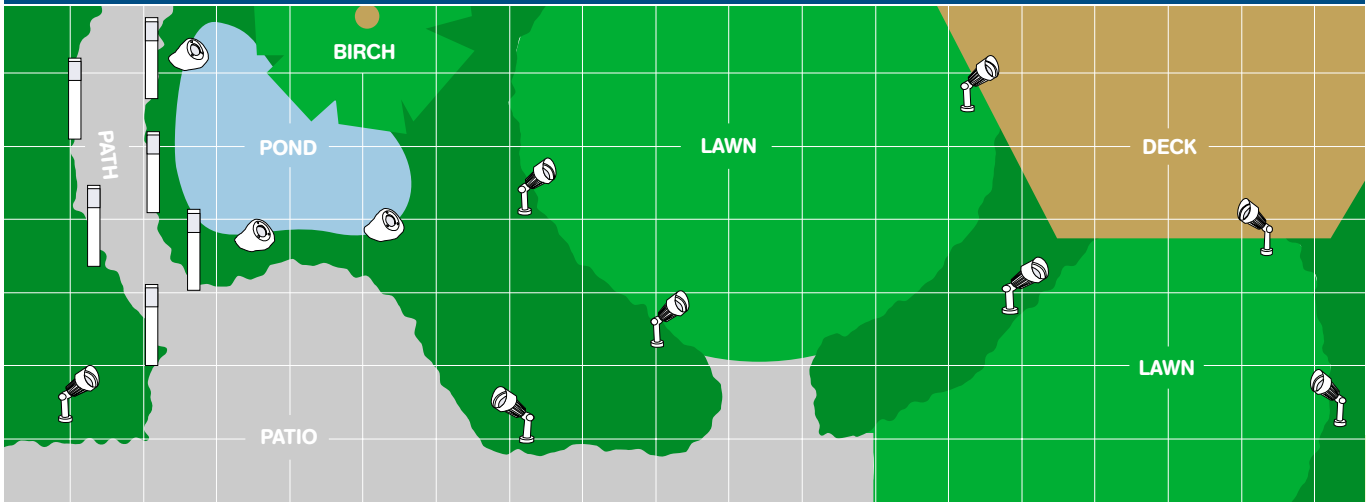

Step 2: Select your light fittings



Step 3: Select the appropriate cable length

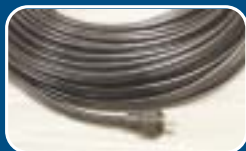

Step 4: Select an appropriate transformer by adding together the wattage of your chosen fittings

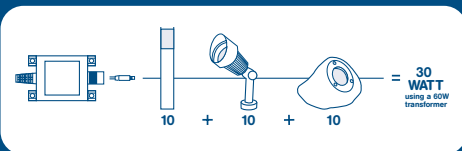

Step 5: Position fittings along the length of cable and include timer or PIR if desired



Step 6: Plug into an outdoor or indoor socket

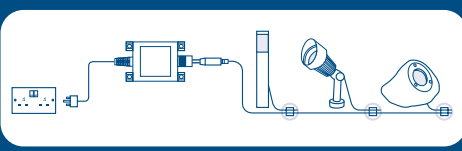

Code	Description
GGLLPT	PIR with timer (require GGLLJ32 connectors)
GGLLT	Timer (require GGLLJ32 connectors)
Transformers	
GGLLTR60	60VA Transformer with screw connector
GGLLTR105	105VA Transformer with screw connector
Cable	
GGLLC15M	15 metre SPT-1 cable
GGLLC315M	15 metres x SPT-3 cable with screw connector
GGLLC325M	25 metres x SPT-3 cable with screw connector
Lamps & accessories	
GGLLL10W	2 x 10W spare wedge lamps
GGLLL10MR11	2 x 10W MR11 lamps
EZClick connectors	
GGLLJ31	2 x garden light 3-1 connectors
GGLLJ32	2 x garden light 3-2 connectors (for use with GGLLPT & GGLLT)
GGLLJ11	2 x garden light 1-1 connectors

- Timer has 3 settings, dusk to dawn, 3 hour or PIR to provide a wide choice of possible selections

Dimensions:
102 (L) x 63 (W) x 75mm (D) 60VA
120 (L) x 80 (W) x 75mm (D) 105VA

15m cable to extend GGLLMC315M (or GGLC325M), requires 1 x GGLLJ31 connector

- Connectors use a numbering system that applies to the diameter of the SPT cable. ie a GGLLJ31 is a 3-1 connector will connect one piece of SPT3 cable to SPT1 cable

- Fully weatherproof

- IP44

Light | Outdoor lighting | LED Decklights, pebbles & sticks



LED decklight kit – 4 twin LED light units



Code	Description	Qty
GGLLEDK4W	LED decklight kit with stainless steel finish and 4 twin LED light units, 10m cable, low voltage transformer, connectors and a 25mm drill bit	1

Lamp Colour: White

Features

- LED Life of up to 100,000 hours (non replaceable)
- Operate cool - safe to touch when operating (safe for children/pets)
- Fully compatible with GET low voltage cable and transformers to add into an existing system
- Includes 12V 10VA transformer
- Up to 20 LEDs can be run on the transformer supplied
- Illuminate step edges for added safety
- Decorate your decking/flooring
- LED's are less damaging to the environment than incandescent lamps as they use up to 90% less energy



Add-on units – for use with GET LED decklight kit



Code	Description	Qty
GGLLED1W	LED decklight add-on	1
GGLLED1G	LED decklight add-on	1
GGLLED1A	LED decklight add-on	1
GGLLED1B	LED decklight add-on	1
GGLLED1R	LED decklight add-on	1

Lamp colour : White

Lamp colour : Green

Lamp colour : Amber

Lamp colour : Blue

Lamp colour : Red

Features

- Each LED uses 0.3W of power so up to 20 can be used instead of one 10W lamp in a typical low voltage installation

As used on the LED decklights

EZClick connector



White LED Pebble Kit



Code	Description	Qty
GGLLEDK10P	10 white pebble kit	1

- 12V low voltage fitting
- 10 White LED pebbles (permanently fixed to cable)
- 15m cable, pebbles spaced 0.5m apart over the last 5m
- Indoor plug in transformer included
- Suitable for indoor or outdoor use



LED Acrylic Sticks



Code	Description	Qty
GGLLEDKT	single LED acrylic stick on metal tube	1
GGLLEDK4T	LED Acrylic 4 stick kit	1

each light contains 2 bright white LED's fitted with 0.5m of SPT-1 cable approx and EZClick connector

Overall height 320mm (200mm of acrylic & 120mm of metal tube)

kit includes:

- 4 acrylic sticks, 15m SPT-1 Cable and an indoor transformer each light fitted with 0.5m of SPT-1 cable approx and EZClick connector
- Up to an additional 20 acrylic stick lights can be added to this system





Pagoda & spotlight kits

Spotlight kit



GGLLK4S

Code	Description	Qty
GGLLK4P	4 pagoda kit	1
GGLLK4S	4 spot kit	1

Pagoda kit



GGLLK4P

Pagoda and spotlight kit features:

- Kit of four fittings supplied c/w transformer and 15m SPT-2 cable
- 3 year guarantee



Stainless steel post lights

Postlight



GGLLPS10

Pagoda



GGLLLPS

Code	Description	Qty
GGLLLPS	Stainless steel pagoda	1
GGLLPRS10	Stainless steel postlight with shade rings	1
GGLLPS10	Stainless steel postlight plain	1



GGLLPRS10

Lamps: 10W wedge

Features:

- Low voltage fitting
- Suitable for decking, pathways and walls
- Lamp type: 10W Wedge lamp (postlight) and 10W JC (pagoda)
- Fitted with 0.5m of SPT - 1 cable approx and **EZClick** connector
- 3 year guarantee
- Diecast spike for use in borders, lawns and gravel drives etc.



Tall postlights



GGLMLP20

Code	Description	Qty
GGLMLP20	3 head tall postlight modern style in antique bronze finish	1

Lamps: G4 20W

Dimensions: 2005 (H) x 605mm (W)

- Includes 20W G4 lamps and a 60VA transformer located in the base of the fitting
- Easy installation (12V) requires no steel armoured cable
- Can be connected into system using **EZClick** connectors

For weights and dimensions please see technical section page 192



Light | Outdoor lighting | Low voltage

Deck lights, spotlights & bollard lights



Deck lights, spotlights & bollards

Die-cast bollard light



GGLLBPV

Die-cast spotlight



GGLLSPPB

Code	Description	Qty
GGLLDDV	Deck downlighter	1
GGLLDDB	Deck downlighter	1
GGLLDUV	Deck uplight	1
GGLLDUB	Deck uplight	1
GGLLDUS	Deck uplight	1
GGLLSPPB	Diecast spotlight	1
GGLLSPPV	Diecast spotlight	1
GGLLBPT	Diecast bollard light	1
GGLLBPB	Diecast bollard light	1
GGLLBPV	Diecast bollard light	1

Colour: Verdigris	Lamp: 10W wedge
Colour: Black	Lamp: 10W wedge
Colour: Verdigris	Lamp: 20W MR16
Colour: Black	Lamp: 20W MR16
Colour: Stainless steel	Lamp: 20W MR16
Colour: Black	Lamp: 20W MR16
Colour: Verdigris	Lamp: 20W MR16
Colour: Titanium	Lamp: 10W JC TH
Colour: Black	Lamp: 10W JC TH
Colour: Verdigris	Lamp: 10W JC TH

Downlighter



GGLLDDV

Deck uplight



GGLLDUV

Dimensions:

Downlighter: 136mm diameter

Decklighter: 105mm diameter
20mm height

Spotlight: 120 (H) x 150mm (W)

Bollard: 250 (H) x 166mm (W)

Features:

- Wall mounting
- Lamp type: 10W Wedge lamp
- Fitted with 0.5m of SPT - 1 cable approx and **EZClick** connector
- For weights and dimensions please see technical section page 192
- 3 year guarantee

Die-Cast Spotlight

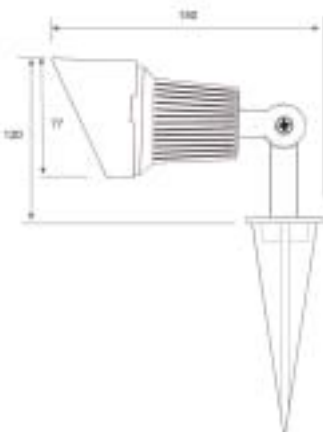

See also our LED Decklight kit on page 147. Up to 20 LED fittings can be run on the transformer supplied with the kit. Alternatively up to 20 LED fittings can be substituted for one 10W low voltage light on the circuit. They both use the **EZClick** connector and cable system.

LED decklight kit



Light | Outdoor lighting | Low voltage

Stone effect postlight & 6 sided lanterns



Stone effect postlight & bollards (includes lamp)



Code	Description	Qty
GGLLSRP	Round postlight	1
GGLLSRB	Round bollard light	1
GGLLSSTB	Square bollard with glass tier diffuser	1

- Lamps: 20W MR16
- Lamps: 10W wedge lamp
- Lamps: 20W MR16

Features:

- 12V Low voltage fitting
- Clear white halogen light
- Suitable for mounting on decking, pathways and walls
- Fitted with 0.5m of SPT - 1 cable approx and **EZClick** connector
- For weights and dimensions please see technical section page 192
- 3 year guarantee



Kit options (triple packs - includes lamps)

Code	Description	Qty
GGLL6PBK3	6 sided lantern postlight kit supplied c/w cable and transformer	3
GGLL6HB3	Crooklight kit	3
GGLL6HV3	Crooklight kit	3

- Lamps: 10W wedge
- Colour: Black

- Colour: Black
- Colour: Verdigris

- All kits contain 3 lights, 15m SPT-3 cable and a transformer
- Fitted with 0.5m of SPT - 1 cable approx and **EZClick** connector

6 sided lantern crooklights and wall light (includes lamp)



Code	Description	Qty
GGLL6PV	6 sided lantern postlight	1
GGLL6PB	6 sided lantern postlight	1
GGLL6PT	6 sided lantern postlight	1
GGLL6HV	6 sided lantern crooklight	1
GGLL6HB	6 sided lantern crooklight	1
GGLL6HT	6 sided lantern crooklight	1
GGLL6WV	6 sided lantern wall light	1
GGLL6WB	6 sided lantern wall light	1
GGLL6WT	6 sided lantern wall light	1

- Colour: Verdigris
- Colour: Black
- Colour: Titanium

- Colour: Verdigris
- Colour: Black
- Colour: Titanium

- Colour: Verdigris
- Colour: Black
- Colour: Titanium

Features:

- 12V low voltage fitting
- Manufactured from die cast alloy
- Lamp type: 10W Wedge lamp included
- Fitted with 0.5m of SPT - 1 cable approx and **EZClick** connector
- For weights and dimensions please see technical section page 192
- 3 year guarantee

Light | Outdoor lighting | Low voltage

Stone effect novelty



Stone effect low level spotlights (includes lamp)



Code	Description	Qty
GGLLSRO	Rock	1
GGLLSSH	Shell	1
GGLLSSN	Snail	1
GGLLSTU	Turtle	1
GGLLSFR	Frog	1

- Features:
- Low Voltage fitting (12V)
 - IP68 submersible to 0.5m max.
 - 10W MR11 dichroic lamp provides clear white light
 - Fitted with 0.5m of SPT-1 cable approx and **EZClick** connector
 - 3 year guarantee



Kit options (triple pack, includes lamp)



Code	Description	Qty
GGLLSROK3	3 x Rock kit supplied c/w 10m cable & transformer IP68 rated	1
GGLLSROK2	2 x Baby rock kit supplied c/w 10m cable & transformer for indoor use	1

- Baby rock features:
- Complete with 5W Halogen lamps
 - Stone effect resin finish
 - Not for outdoor use (best used in conservatories)
 - For weights and dimensions please see technical section page 192
 - 3 year guarantee

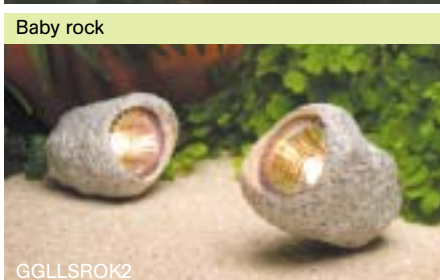

Rock kit for use directly in water features



Diecast caplights & stormglass postlights (includes lamp)

Caplight postlight



GLLCPV

Code	Description	Qty
GLLCPV	Caplight postlight	1
GLLCPB	Caplight postlight	1
GLLCPT	Caplight postlight	1
GLLCHV	Caplight crooklight	1
GLLCHB	Caplight crooklight	1
GLLCHT	Caplight crooklight	1
GLLCWV	Caplight wall light	1
GLLCWB	Caplight wall light	1
GLLCWT	Caplight wall light	1
GLLSPSB	Diecast stormglass postlight	1
GLLSPSV	Diecast stormglass postlight	1
GLLSPST	Diecast stormglass postlight	1

Lamps: 10W wedge

- Colour: Verdigris
- Colour: Black
- Colour: Titanium
- Colour: Verdigris
- Colour: Black
- Colour: Titanium
- Colour: Verdigris
- Colour: Black
- Colour: Titanium
- Colour: Black
- Colour: Verdigris
- Colour: Titanium

Features:

- Low Voltage fitting
- Manufactured from die cast alloy
- Lamp type: 10W Wedge lamp
- Fitted with 0.5m of SPT - 1 cable approx and **EZClick** connector
- For weights and dimensions please see technical section page 192
- 3 year guarantee
- IP44

Caplight crooklight



GLLCHB

Caplight wall light



GLLCWT

Storm glass postlight



GLLSPSB

Kit options (triple packs - includes lamps)

Code	Description	Qty
GLLCPB3	Caplight postlight kit	1
GLLCHB3	Caplight crooklight kit	1

- Colour: Black
- Colour: Black

- All kits contain 3 lights, 15m SPT-3 cable and a transformer
- Fitted with 0.5m of SPT - 1 cable approx and **EZClick** connector



Products are die-cast from high grade aluminium. By chemical treatment to the chrome, a better surface is obtained for the powder coating that prevents corrosion. By using UV stabilizers in the powder coating the colour will keep its original look for many years.

Light | Outdoor lighting | Low voltage Lanterns and postlights



Diecast decorative lights (includes lamp)

Halo postlight



GGLLHPV

Code	Description	Qty
GGLLHPV	Halo postlight	1
GGLLHPB	Halo postlight	1
GGLLHPT	Halo postlight	1
GGLLHPV	Japanese lantern postlight	1
GGLLHPB	Japanese lantern postlight	1
GGLLHPV	Pagoda crooklight	1
GGLLHPB	Pagoda crooklight	1

Colour: Verdigris	Lamps: 10W JC TH
Colour: Black	Lamps: 10W JC TH
Colour: Titanium	Lamps: 10W JC TH
Colour: Verdigris	Lamps: 10W wedge
Colour: Black	Lamps: 10W wedge
Colour: Verdigris	Lamps: 10W wedge
Colour: Black	Lamps: 10W wedge

Dimensions

Halo:	230 (H) x 155mm (W)
Japanese lantern:	367 (H) x 150mm (W)
Pagoda crooklight:	452 (H) x 120mm (W)

Features:

- Low Voltage Fitting
- Manufactured from die cast alloy
- Lamp type: Postlight – 10W JC crooklight
- Lamp type: Crooklight – 10W
- Fitted with 0.5m of SPT - 1 cable approx and **EZClick** connector
- For weights and dimensions please see technical section page 192
- 3 year guarantee
- IP44

Japanese lantern postlight



GGLLHPV

Pagoda Crooklight



GGLLHPV



Halo kit



GGLLHPBK3

Kit options (triple packs - includes lamps)

Code	Description	Qty
GGLLHPBK3	Halo postlight kit supplied c/w cable and transformer	1
GGLLHPV3	Halo light kit	1

Colour: Black
Colour: Verdigris

- All kits contain 3 lights, 15m SPT-3 cable and transformer
- Fitted with 0.5m of SPT - 1 cable approx and **EZClick** connector
- See above for lamp and dimension details
- IP44

Light | Outdoor lighting | Low voltage

Pagoda postlights



Die-cast decorative lights (includes lamp)

Die-cast pagoda post lights



Code	Description	Qty
GGLLKPS	pagoda post circular top	1
GGLLKPG	pagoda post circular top	1
GGLLK3RS	pagoda post 3 glass rings	1
GGLLK3RG	pagoda post 3 glass rings	1
GGLLK5RS	pagoda post 5 diecast rings	1
GGLLK5RGY	pagoda post 5 diecast rings	1
GGLLKPPS	pagoda post pyramid top	1
GGLLKPPGY	pagoda post pyramid top	1

colour: silver
 colour: granite
 colour: silver
 colour: granite
 colour: silver
 colour: grey
 colour: silver
 colour: grey

- low voltage fittings
- manufactured from die cast alloy
- each light fitted with 0.5m of SPT-1 cable approx and **EZClick** connector
- lamp type:- 10W halogen capsule
- IP44

kit options (4 light kit)

Die-cast pagoda post lights



Code	Description	Qty
GGLLK4PS	pagoda post circular top	1
GGLLK4PG	pagoda post circular top	1
GGLLK4P3RS	pagoda post 3 glass rings	1
GGLLK4P3RG	pagoda post 3 glass rings	1
GGLLK4P5RS	pagoda post 5 diecast rings	1
GGLLK4P5RGY	pagoda post 5 diecast rings	1
GGLLK4PPS	pagoda post pyramid top	1
GGLLK4PPGY	pagoda post pyramid top	1

colour: silver
 colour: granite
 colour: silver
 colour: granite
 colour: silver
 colour: grey
 colour: silver
 colour: grey

Each kit contains;

- 4 lights each fitted with 0.5m of SPT-1 cable
- 15M cable and 4 connectors
- 4 deck mounting bases and ground spikes
- 10W halogen capsule lamps
- 60VA outdoor transformer
- for weights and dimensions please see technical section page 192

2 extra lights and extra cable can be added



Light | Outdoor lighting | Mains voltage

Mains voltage exterior lanterns can offer simple, traditional styling or more dramatic, contemporary designs. Compatible with a variety of lamp types – from golf ball or candle lamps to energy saving compact fluorescent lamps – post, wall mounting or hanging options also provide the flexibility to mount these highly practical lanterns to suit your specific needs.

Features and benefits

Modern stainless steel postlights

Traditional 6 sided lanterns with glass tops to diffuse light evenly

Modern style wall, post & hanging versions

Steel & copper finishes

Tall postlights in a modern or traditional style with matching wall lights

Light | Outdoor lighting | Mains voltage

Tall postlights, wall lights & stainless steel posts



Tall postlights & wall lights (lamp required)



GGLMLPMBR

Code	Description	Qty
GGLMLPMBR	3 head tall post light modern antique bronze	1
GGLMCAB	Modern wall light antique bronze	1
GGLMCB	Modern wall light black	1
GGLMCLCAB	Traditional wall light antique bronze	1
GGLMCLB	Traditional wall light black	1

Lamps: BC GLS or BC energy saving

- Can also use energy saving lamps (see page 163)
- 3 year guarantee

- Can also use energy saving lamps (see page 163)
- 3 year guarantee

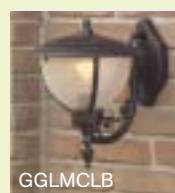

GGLMCLB

Stainless steel posts (lamp required)

Wall post



GGLMWRS

Code	Description	Qty
GGLMWRS	Stainless steel wall post	1
GGLMSPRS	Stainless steel short post	1
GGLMTPRS	Stainless steel tall post	1

Lamps: ES or energy saving

Dimensions: 340 (H) x 140mm (Dia)

Dimensions: 309 (H) x 140mm (Dia)

Dimensions: 810 (H) x 140mm (Dia)

Features:

- Lamp type: 60W Max (ES) Golfball or 11W energy saving lamp (see page 148)
- Stainless steel and glass construction
- Posts are suitable for decking, pathways and walls
- For weights and dimensions please see technical section page 192



Steel & Copper exterior lanterns (lamp required)

Hanging lantern



GGLMH999G

Code	Description	Qty
GGLMH999G	Hanging lantern	1
GGLMH999C	Hanging lantern	1
GGLMWS999G	Straight wall lantern	1
GGLMWS999C	Straight wall lantern	1

Lamps: ES, GLS, golfball or candle

Colour: Galvanised steel
Copper

Dimensions: 875 (H) inc. chain x 270mm (W)

Colour: Galvanised steel
Copper

Dimensions: 400 (H) x 270mm (W)

Straight wall lantern



GGLMWS999C

Features:

- Lamp type: 75W max (ES) GLS, Golfball or Candle lamp
- Galvanised steel / copper & glass construction
- Can also use energy saving lamps (see page 163)
- For weights and dimensions please see technical section page 192

Light | Outdoor lighting | Mains voltage Traditional & modern style lanterns



Traditional style die cast exterior lanterns (lamp required)

Hanging lantern



GGLMH640W

4 sided lantern



GLAN4SB

Code	Description	Qty
GGLMH640W	Hanging lantern	1
GGLMWU640W	Wall up lantern	1
GGLMWU640B	Wall up lantern	1
GGLMWD640W	Wall down lantern	1
GGLMWD640B	Wall down lantern	1
GGLMP640W	Post top lantern	1
GGLMP640B	Post top lantern	1
GLAN4SB	4 sided lantern	1
GLAN4SPTB	4 sided post top lantern	1
GLAN6SB	6 sided lantern	1
GLAN6SPTB	6 sided post top lantern	1

Wall up lantern



GGLMWU640B

Wall down lantern



GGLMWD640W

Post top lanterns



GLAN6SPTB

Lamps: ES, GLS, golfball, candle or energy saving

Colour: White

Colour: White

Colour: Black

Colour: White

Colour: Black

Colour: White

Colour: Black

Colour: Black

Colour: Black

Colour: Black

Traditional style lantern

- Bevelled edge glass for decorative effect
- Ideal for lighting doorways and patios
- Vandal proof construction
- Die cast construction for durability
- For use with Golfball or Candle lamps
- Weatherproof IP43
- Can also use energy saving lamps (page 163)
- Lamp type: 60W Max (ES) GLS, Golfball or Candle lamps

4-6 sided lantern features:

- Lamp type: 60W Max (ES) GLS, Golfball or Candle lamps
- Die cast and glass construction
- Can also use energy saving lamps (page 163)

Modern style die cast exterior lanterns (lamp required)

Hanging lantern



GGLMH540T

Code	Description	Qty
GGLMH540W	Hanging lantern	1
GGLMH540B	Hanging lantern	1
GGLMH540T	Hanging lantern	1
GGLMWU540W	Wall up lantern	1
GGLMWU540B	Wall up lantern	1
GGLMWU540T	Wall up lantern	1
GGLMWD540W	Wall down lantern	1
GGLMWD540B	Wall down lantern	1
GGLMWD540T	Wall down lantern	1
GGLMP540W	Post top lantern	1
GGLMP540B	Post top lantern	1
GGLMP540T	Post top lantern	1

Lamps: ES, GLS, golfball or candle

Colour: White

Colour: Black

Colour: Titanium

Dimensions: 240 (W) x 255mm (D)

Colour: White

Colour: Black

Colour: Titanium

Dimensions: 340 (H) x 240mm (W)

Colour: White

Colour: Black

Colour: Titanium

Dimensions: 400 (H) x 240mm (W)

Colour: White

Colour: Black

Colour: Titanium

Dimensions: 395 (H) x 240mm (W)

Wall up lantern



GGLMWU540B

Features:

- Lamp type: 60W max (ES) GLS, Golfball or Candle lamps
- Die cast and polycarbonate construction
- Can also use energy saving lamps (see page 164)
- For weights and dimensions please see technical section page 192



Light | Lamps range

Range overview



Incandescent (Pages 159-160)

- Universal lamp satisfying diverse lighting requirements.
- Easily dimmable
- Flexible and versatile with no need for electronic starting and control systems
- Pearl, clear and soft white
- Bayonet and screw caps



Halogen (Pages 161-162)

- Compact crisp white uniform light output
- Dimmable
- Uses energy more efficiently
- Longer life
- Small filaments give better beam control for directional light
- Mains and low voltage



Compact fluorescent (Page 163)

- Low energy consumption and maintenance
- Perfect choice for use in slim luminaires
- Suitable for up-lighting and down-lighting
- Colour temperatures – warm white 2700K and white 3500K



Striplights (Page 162)

- Double ended tubular lamp
- Suitable for use with shaver light units
- Opal or clear



Energy saving (Page 163)

- Low energy consumption and maintenance
- Retrofit designs to replace incandescent lamps
- Wide range of wattages and sizes
- Incandescent equivalent wattage listed



T4 & T5 Miniature fluorescent (Page 164)

- High energy efficiency
- Colour temperatures – cool white 3300K and white 3000K
- Wide range of wattages and lengths



Light | Lamps range

Incandescent



GLS



GLS40WCLBC

Code	Watts	Volts
GLSNL12WCLBC	nightlight 12W	240V
GLS40WCLBC	40W	240V
GLS40WPBC	40W	240V
GLS40WCLES	40W	240V
GLS40WPES	40W	240V
GLS60WCLBC	60W	240V
GLS60WPBC	60W	240V
GLS60WCLES	60W	240V
GLS60WPES	60W	240V
GLS100WCLBC	100W	240V
GLS100WPBC	100W	240V
GLS100WCLES	100W	240V
GLS100WPES	100W	240V

Cap:	Finish:
BC	Clear
BC	Clear
BC	Pearl
ES	Clear
ES	Pearl
BC	Clear
BC	Pearl
ES	Clear
ES	Pearl
BC	Clear
BC	Pearl
ES	Clear
ES	Pearl

• Universal lamps satisfying diverse lighting requirements

Candle



CNDL25WCLES

Code	Watts	Volts
CNDL25WCLBC	25W	240V
CNDL25WCLES	25W	240V
CNDL25WCLBSC	25W	240V
CNDL25WCLSES	25W	240V
CNDL40WCLBC	40W	240V
CNDL40WCLES	40W	240V
CNDL40WSWBC	40W	240V
CNDL40WCLBSC	40W	240V
CNDL40WSWSBC	40W	240V
CNDL40WCLSES	40W	240V
CNDL40WSWSES	40W	240V
CNDL60WCLBSC	60W	240V
CNDL60WCLSES	60W	240V
CNDL60WCLBC	60W	240V
CNDL60WCLES	60W	240V
CNDL60WSWBC	60W	240V

Cap:	Finish:
BC	Clear
ES	Clear
SBC	Clear
SES	Clear
BC	Clear
ES	Clear
BC	Soft white
SBC	Clear
SBC	Soft white
SES	Clear
SES	Soft white
SBC	Clear
SES	Clear
BC	Clear
ES	Clear
BC	Soft white

• Enhance any room using decorative wall or ceiling luminaires with candle lamps

Decorative round (45mm)



G4560WSWSES

Code	Watts	Volts
G4525WSWSES	25W	240V
G4525WSWBC	25W	240V
G4540WCLBC	40W	240V
G4540WSWBC	40W	240V
G4540WSWES	40W	240V
G4540WSWSBC	40W	240V
G4540WCLSES	40W	240V
G4540WSWSES	40W	240V
G4560WCLBC	60W	240V
G4560WSWBC	60W	240V
G4560WSWES	60W	240V
G4560WSWSBC	60W	240V
G4560WCLSES	60W	240V
G4560WSWSES	60W	240V

Cap:	Finish:
SES	Soft white
BC	Soft white
BC	Clear
BC	Soft white
ES	Soft white
SBC	Soft white
SES	Clear
SES	Soft white
BC	Clear
BC	Soft white
ES	Soft white
SBC	Soft white
SES	Clear
SES	Soft white

• Compact and attractive lamp designed for small decorative luminaires

Light | Lamps range

Incandescent and Halogen



Pygmy



PYG15WBC

Code	Description	Watts
PYG15WBC	appliance	15W
PYG15WSBC	appliance	15W
PYG15WSES	appliance	15W
PYG15WSEFRG	fridge	15W
PYG25WBC	appliance	25W
PYG25WSBC	appliance	25W
PYG25WSES	appliance	25W
PYG40WSESCH	cooker hood	40W
PYG40WSESOV	oven	40W

Volts: 240V

Cap: BC	Finish: Clear
Cap: SBC	Finish: Clear
Cap: SES	Finish: Clear
Cap: SES	Finish: Clear
Cap: BC	Finish: Clear
Cap: SBC	Finish: Clear
Cap: SES	Finish: Clear
Cap: SES	Finish: Clear
Cap: SES	Finish: Clear

- For use in a wide range of domestic applications such as cooker hoods, refrigerators and sewing machines.
- Highly reliable and compact in size

Striplights



Code	Watts	Volts
STRP30WCL221	30W	240V
STRP30WOP221	30W	240V
STRP30WCL284	30W	240V
STRP30WOP284	30W	240V
STRP60WCL221	60W	240V
STRP60WOP221	60W	240V
STRP60WCL284	60W	240V
STRP60WOP284	60W	240V

Length (mm): 221	Cap: S15S	Finish: Clear
Length (mm): 221	Cap: S15S	Finish: Opal
Length (mm): 284	Cap: S15S	Finish: Clear
Length (mm): 284	Cap: S15S	Finish: Opal
Length (mm): 221	Cap: S15S	Finish: Clear
Length (mm): 221	Cap: S15S	Finish: Opal
Length (mm): 284	Cap: S15S	Finish: Clear
Length (mm): 284	Cap: S15S	Finish: Opal

- For use with strip lights and shaver lights

PAR 38



PAR38FL120WES

Code	Watts	Volts
PAR38FL120WES	120	240V

Cap: ES Beam: Flood

Reflectors



R8060WES

Code	Watts	Volts
R3930WSES	30W	240V
R6340WES	40W	240V
R5040WSES	40W	240V
R8060WES	60W	240V
R6360WES	60W	240V
R80100WES	100W	240V

Cap: R39 - SES
Cap: R63 - ES
Cap: R50 - SES
Cap: R80 - ES
Cap: R63 - ES
Cap: R80 - ES

- Spotlight reflectors direct a beam of light to the desired areas
- Ideal for display lighting

Halogen capsule



HC25WFRG9

Code	Watts	Volts
Low voltage halogen capsules		
HC5WG4	5W	12V
HC10WG4	10W	12V
HC20WG4	20W	12V
HC50WM32	50W	12V
GGLLL10W	10W	12V
Mains halogen capsules		
HC25WCLG9	25W	240V
HC25WFRG9	25W	240V
HC40WCLG9	40W	240V
HC40WFRG9	40W	240V
HC60WCLG9	60W	240V
HC60WFRG9	60W	240V

Cap: G4
 Cap: G4
 Cap: G4
 Cap: G6.35
 Cap: Wedge

Cap: G9 Finish: Clear
 Cap: G9 Finish: Frosted
 Cap: G9 Finish: Clear
 Cap: G9 Finish: Frosted
 Cap: G9 Finish: Clear
 Cap: G9 Finish: Frosted

- Halogen capsules suitable for interior display use including shop windows and restaurants

Mains aluminised halogen



HPAR1640WSES

HD20WGU10

Code	Watts	Volts
HD20WGU10	20W	240V
HD35WGU10	35W	240V
HD50WGU10	50W	240V
HPAR1640WSES	40W	240V
HPAR1650WSES	50W	240V

Cap: GU10 Beam: 36°
 Cap: GU10 Beam: 36°
 Cap: GU10 Beam: 36°
 Cap: PAR16 Beam: 30°
 Cap: PAR16 Beam: 36°

- Providing crisp clean light for use in downlighters and uplighters
- Suitable for dimming
- Does not require transformer

Low voltage dichroic halogen and aluminised



Code	Watts	Volts
Dichroic		
HD20WM252	20W	12V
HD20WM251	20W	12V
HD20WM262	20W	12V
HD20WM268	20W	12V
HD20WM294	20W	12V
HD20WM269	20W	12V
HD20WM2692	20W	12V
HD35WM265	35W	12V
HD35WM266	35W	12V
HD35WM299	35W	12V
HD35WM271	35W	12V
HD35WM270	35W	12V
HD35WM281	35W	12V
HD50WM249	50W	12V
HD50WM250	50W	12V
HD50WM258	50W	12V
HD50WM2582	50W	12V
GGLLL10MR11	10W	12V

Aluminised		
HD50WM2582A	50W	12V

Cap: MR11 – GU4 Beam: 12°
 Cap: MR11 – GU4 Beam: 24°
 Cap: MR11 – GU4 Beam: 38°
 Cap: MR16 – GU5.3 Beam: 12°
 Cap: MR16 – GU5.3 Beam: 24°
 Cap: MR16 – GU5.3 Beam: 38°
 Cap: MR16 – GU5.3 Beam: 38°
 Cap: MR11 – GU4 Beam: 12°
 Cap: MR11 – GU4 Beam: 24°
 Cap: MR11 – GU4 Beam: 38°
 Cap: MR16 – GU5.3 Beam: 12°
 Cap: MR16 – GU5.3 Beam: 24°
 Cap: MR16 – GU5.3 Beam: 38°
 Cap: MR16 – GU5.3 Beam: 38°
 Cap: MR11 – GU4

Cap: MR16 - GU5.3 Beam 38°

GU4: Average rated life 3500 hours

GU5.3: Average rated life 4000 hours

M2692 & M2582: Average rated life 2000 hours

- Suitable for display lighting
- Suitable for dimming

Light | Lamps range

Halogen



Mains JTT halogen



Code	Watts	Volts
HJTT60WCLBC	60W	240V
HJTT60WCLES	60W	240V

Cap: BC Finish: Clear
 Cap: ES Finish: Clear

- Can directly replace standard lamps providing crisp clean white light
- Suitable for domestic and commercial interior use

Mains linear tungsten halogen



Code	Watts	Volts
HL100W	100W	240V
HL150W78	150W	240V
HL150W118	150W	240V
HL200W	200W	240V
HL300W	300W	240V
HL310W	300W	110V
HL500W	500W	240V
HL510W	510W	110V
HL750W	750W	240V
HL1000W	1000W	240V
HL1010W	1000W	110V
HL1500W	1500W	240V

Cap: R7s Length: 78mm
 Cap: R7s Length: 78mm
 Cap: R7s Length: 118mm
 Cap: R7s Length: 118mm
 Cap: R7s Length: 118mm
 Cap: R7s Length: 118mm
 Cap: R7s Length: 118mm
 Cap: R7s Length: 118mm
 Cap: R7s Length: 189mm
 Cap: R7s Length: 189mm
 Cap: R7s Length: 169mm
 Cap: R7s Length: 254mm

- Suitable for floodlights, up lights and displays where light and colour rendering are important
- Suitable for dimming

Mains halogen



Code	Watts	Volts
Reflector		
HR5040WSES	40W	240V
HR6360WES	60W	240V
HR8060WES	60W	240V

Cap: R50 – SES
 Cap: R63 – ES
 Cap: R80 – ES

Code	Watts	Volts
Candle		
HCNDL60WCLBC	60W	240V
HCNDL60WCLES	60W	240V

Cap: BC Finish: Clear
 Cap: ES Finish: Clear

- Mains halogen can be used to directly replace standard lamps



Light | Lamps range

Low energy



Energy saving



CFL11W827BC



CFL20W827ES

Code	Watts	Equivalent	
		GLS	Volts
CFL9W827BC	9W	40W	240V
CFL9W827ES	9W	40W	240V
CFL11W827BC	11W	60W	240V
CFL11W827ES	11W	60W	240V
CFL15W827BC	15W	75W	240V
CFL15W827ES	15W	75W	240V
CFL20W827BC	20W	100W	240V
CFL20W827ES	20W	100W	240V

Cap: BC
Cap: ES
Cap: BC
Cap: ES
Cap: BC
Cap: ES
Cap: BC
Cap: ES

Size: Standard



Colour temperature: 827 Warm white 2700K

- Average rated life 8000 hours
- Energy saving lamps are not suitable for dimming and should not be used with dimmers, electronic switches or timers as this can shorten the product life.
- Ideal for applications where the lamp is on for long periods
- High quality manufactured lamp type to suit a variety of luminaires

Tubular compact double D 2 pin



CFLDD28W8354P

Code	Watts	Volts
CFLDD16W8272P	16W	240V
CFLDD16W8352P	16W	240V
CFLDD28W8272P	28W	240V
CFLDD28W8352P	28W	240V

Colour temperature:

Cap: GR8 827 Warm white 2700K
Cap: GR8 835 White 3500K
Cap: GR8 827 Warm white 2700K
Cap: GR8 835 White 3500K



- Average rated life 8000 hours
- Not suitable for dimming

Tubular compact double D 4 pin

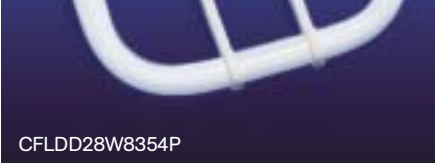

CFLDD28W8354P

Code	Watts	Volts
CFLDD16W8274P	16W	240V
CFLDD16W8354P	16W	240V
CFLDD28W8274P	28W	240V
CFLDD28W8354P	28W	240V
CFLDD38W8274P	38W	240V
CFLDD38W8354P	38W	240V

Colour temperature:

Cap: GR10 827 Warm white 2700K
Cap: GR10 835 White 3500K
Cap: GR10 827 Warm white 2700K
Cap: GR10 835 White 3500K
Cap: GR10 827 Warm white 2700K
Cap: GR10 835 White 3500K



- Can be dimmed with suitable control gear

Standard compact fluorescent



CFL11W8272P

Code	Watts	Equivalent	
		GLS	Volts
CFL9W8272P	9W	40W	240V
CFL9W8274P	9W	40W	240V
CFL9W8402P	9W	40W	240V
CFL9W8404P	9W	40W	240V
CFL11W8272P	11W	60W	240V
CFL11W8274P	11W	60W	240V
CFL11W8402P	11W	60W	240V
CFL11W8404P	11W	60W	240V
CFL13W8272P	13W	60W	240V
CFL13W8274P	13W	60W	240V
CFL13W8402P	13W	60W	240V
CFL13W8404P	13W	60W	240V
CFL18W8272P	18W	75W	240V
CFL18W8274P	18W	75W	240V
CFL18W8402P	18W	75W	240V
CFL18W8404P	18W	75W	240V
CFL26W8272P	26W	100W	240V
CFL26W8274P	26W	100W	240V
CFL26W8402P	26W	100W	240V
CFL26W8404P	26W	100W	240V

Cap	Tube	Colour temperature
2 PIN	Dual	827 Warm white 2700K
4 PIN	Quad	827 Warm white 2700K
2 PIN	Dual	840 Cool white 4000K
4 PIN	Quad	840 Cool white 4000K
2 PIN	Dual	827 Warm white 2700K
4 PIN	Quad	827 Warm white 2700K
2 PIN	Dual	840 Cool white 4000K
4 PIN	Quad	840 Cool white 4000K
2 PIN	Quad	827 Warm white 2700K
4 PIN	Quad	827 Warm white 2700K
2 PIN	Quad	840 Cool white 4000K
4 PIN	Quad	840 Cool white 4000K
2 PIN	Quad	827 Warm white 2700K
4 PIN	Quad	827 Warm white 2700K
2 PIN	Quad	840 Cool white 4000K
4 PIN	Quad	840 Cool white 4000K



- Not suitable for dimming



Replacement lamps



T4FL16W35

Code	Watts	Volts	Qty
T4FL6W35	6W	230V	10
T4FL10W35	10W	230V	10
T4FL16W35	16W	230V	10
T4FL20W35	20W	230V	10
T4FL30W35	30W	230V	10

Colour: White 35	Length: 11" 275mm
Colour: White 35	Length: 16" 400mm
Colour: White 35	Length: 20" 500mm
Colour: White 35	Length: 25" 625mm
Colour: White 35	Length: 30" 760mm

• To fit GET mini batten range see page 129

T5 miniature fluorescent tubes



T5FL6W33

Code	Watts	Volts
T5FL4W35	4W	240V
T5FL4W33	4W	240V
T5FL6W35	6W	240V
T5FL6W33	6W	240V
T5FL8W35	8W	240V
T5FL8W33	8W	240V
T5FL13W35	13W	240V
T5FL13W33	13W	240V

Colour: White 35	Length: 6" 150mm
Colour: Cool white 33	Length: 6" 150mm
Colour: White 35	Length: 9" 225mm
Colour: Cool white 33	Length: 9" 225mm
Colour: White 35	Length: 12" 300mm
Colour: Cool white 33	Length: 12" 300mm
Colour: White 35	Length: 21" 525mm
Colour: Cool white 33	Length: 21" 525mm

• Suitable for kitchens, task lighting and emergency lighting

Energy saving pendant



GESPEND613

Code	Description	Qty
GESPEND613	13W Energy saving pendant with 6" flex	1
GESPEND618	18W Energy saving pendant with 6" flex	1

Complies with Part L of the building regulations. Build properties must have a fixed proportion of lighting points suitable for compact fluorescent lamps only.

Requires 1 x 13W 4 pin compact fluorescent lamp (not supplied)
(lamp codes: CFL13W8274P/CFL13W8404P)
or
1 x 18W 4 pin compact fluorescent lamp (not supplied)
(lamp codes: CFL18W8274P/CFL18W8404P)

