

3.3V, 5V, 12V or 24V Input Voltage / 1W / 1.5kV Functional Isolated Unregulated 5V Output

DESCRIPTION

The FISM power module family is an unregulated, functional isolated, fully integrated DC/DC converter.

The module integrates the switching power stage, control circuitry, transformer and input/output capacitors.

The module requires no external components for operation thus reducing design effort and complexity to a minimum.

The FISM ensures fast time to market and low development costs.

The 1779205x11 series of the FISM family achieves typically an efficiency of 82% up to 86%.

The series is available in a SIP-4 package (11.60 x 6 x 10.16mm).

TYPICAL APPLICATIONS

- Data acquisition
- Test and measurement systems
- Interface and microcontroller supplies
- Industrial control

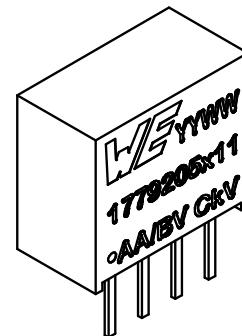

FEATURES

- 1.5kV DC functional isolation for 60s
- Continuous short-circuit protection
- Current capability up to 0.2A
- Nominal input voltage rails: 3.3V / 5V / 12V / 24V
- Output voltage: 5V unregulated
- No minimum load required
- Continuous output power: 1W
- Integrated C_{IN} , C_{OUT} and transformer
- Dynamic power boost up to 300mA for 0.5s
- Low output voltage ripple: Typ. 55mV at full load
- Output voltage accuracy: Typ. +3% / -4.3%
- Operating switching frequency:
 - 300kHz (1779205111)
 - 600kHz (1779205011, 1779205211, 1779205311)
- Operating ambient temperature range: -40°C to 105°C
- RoHS & REACH compliant
- Complies with EN55032 (CISPR-32) class B conducted and radiated emissions standard
- UL62368-1 approved

TYPICAL CIRCUIT DIAGRAM

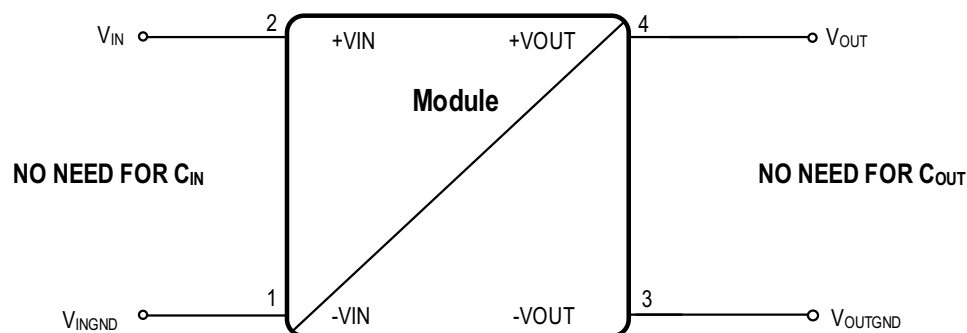

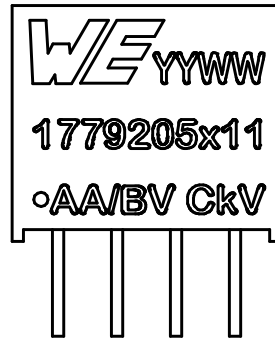

MARKING DESCRIPTION

MARKING	DESCRIPTION
WE	Würth Elektronik eiSos GmbH & Co. KG
YY	Year
WW	Calendar week
1779205X11	Ordering code
AA	Input voltage
B	Output voltage
C	Isolation voltage

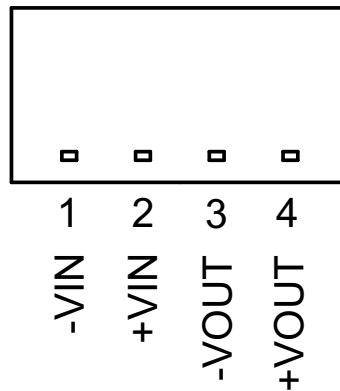

PIN DESCRIPTION

SYMBOL	NUMBER	TYPE	DESCRIPTION
-VIN	1	Power	Input ground pin
+VIN	2	Power	Input voltage pin
-VOUT	3	Power	Output ground pin
+VOUT	4	Power	Output voltage pin

ORDERING INFORMATION

ORDER CODE	PART DESCRIPTION	SPECIFICATIONS	PACKAGE	PACKAGING UNIT
1779205011	-	3.3V _{IN} / 5V _{OUT}	SIP-4	43
1779205111	-	5V _{IN} / 5V _{OUT}	SIP-4	43
1779205211	-	12V _{IN} / 5V _{OUT}	SIP-4	43
1779205311	-	24V _{IN} / 5V _{OUT}	SIP-4	43

SALES INFORMATION

SALES CONTACT
Würth Elektronik eiSos GmbH & Co. KG EMC and Inductive Solutions Max-Eyth-Str. 1 74638 Waldenburg Germany Tel. +49 (0) 7942 945 0 www.we-online.com/powermodules Technical support: powermodules@we-online.com

ABSOLUTE MAXIMUM RATINGS

Caution:

Exceeding the listed absolute maximum ratings may affect the device negatively and may cause permanent damage. These are stress ratings only, which do not imply functional operation of the device at these or any other condition beyond those indicated under Operating Conditions.

SYMBOL	PARAMETER		LIMIT		UNIT
			MIN ⁽¹⁾	MAX ⁽¹⁾	
VIN	Input pin voltage	3.3V _{IN} / 5V _{OUT} version (1779205011)	-0.4	9	V
		5V _{IN} / 5V _{OUT} version (1779205111)	-0.4	6	V
		12V _{IN} / 5V _{OUT} version (1779205211)	-0.4	25	V
		24V _{IN} / 5V _{OUT} version (1779205311)	-0.4	50	V
VOUT	Output pin voltage	3.3V _{IN} / 5V _{OUT} version (1779205011)	-0.7	16	V
		5V _{IN} / 5V _{OUT} version (1779205111)	-0.7	11	V
		12V _{IN} / 5V _{OUT} version (1779205211)	-0.7	16	V
		24V _{IN} / 5V _{OUT} version (1779205311)	-0.7	16	V
V _{ISO}	Isolation voltage input to output for 1s ⁽⁶⁾		-	3000	V
	Isolation voltage input to output, 100% tested for 60s ⁽²⁾		-	1500	V
T _{storage}	Assembled, non-operating storage temperature		-55	125	°C
V _{ESD}	ESD Voltage (HBM), according to EN61000-4-2 ⁽¹⁰⁾		-4	4	kV

OPERATING CONDITIONS

Operating conditions are conditions under which the device is intended to be functional. All values are referenced to their respective GND.

MIN and MAX limits are valid for the recommended ambient temperature range of **-40 °C to 105 °C**. Typical values represents statistically the utmost probability at following conditions: $T_A=25\text{ °C}$, $V_{IN}=3.3\text{V}$ (1779205011), $V_{IN}=5\text{V}$ (1779205111), $V_{IN}=12\text{V}$ (1779205211), $V_{IN}=24\text{V}$ (1779205311), $V_{OUT}=5\text{V}$, $I_{OUT}=\text{nominal}$ unless otherwise stated.

SYMBOL	PARAMETER	MIN ⁽¹⁾	TYP ⁽³⁾	MAX ⁽¹⁾	UNIT	
V_{IN}	Input Voltage	3.3 V_{IN} / 5 V_{OUT} version (1779205011)	2.97	3.3	3.63	V
		5 V_{IN} / 5 V_{OUT} version (1779205111)	4.5	5	5.5	V
		12 V_{IN} / 5 V_{OUT} version (1779205211)	10.8	12	13.2	V
		24 V_{IN} / 5 V_{OUT} version (1779205311)	21.6	24	26.4	V
V_{OUT}	Output Voltage	-	5	-	V	
I_{OUT}	Nominal output current ⁽⁴⁾	-	-	200	mA	
P_{OUT}	Nominal output power (without derating)	-	-	1	W	
C_{OUT_MAX}	Maximal output capacitance	-	-	470	μF	
T_a	Ambient temperature range	-40	-	105	°C	
T_{JOP}	Junction temperature range	-40	-	125	°C	

All parameters are specified after 5 minutes run-in time unless otherwise noted.

THERMAL SPECIFICATIONS

SYMBOL	PARAMETER	TYP ⁽³⁾	UNIT
T_{Case_Max}	Maximum case temperature (top side)	120	°C

ELECTRICAL SPECIFICATIONS

MIN and MAX limits are valid for the recommended ambient temperature range of **-40°C to 105°C**. Typical values represent statistically the utmost probable values at the following conditions: $T_A = 25^\circ\text{C}$, unless otherwise noted.

SYMBOL	PARAMETER	TEST CONDITIONS	MIN ⁽¹⁾	TYP ⁽³⁾	MAX ⁽¹⁾	UNIT
Output Current						
I_{MOC}	Maximum overload current		-	-	300 ⁽⁷⁾	mA
Accuracy						
V_{OUT}	Line regulation	per 1.0% change in input voltage ⁽⁸⁾	-	-	1.2	%
	Load Regulation	V_{IN} nominal, $V_{OUT} = 5V$ $I_{OUT} = 20mA$ to $200mA$	-	5	-	%
	Output voltage accuracy	V_{IN} nominal, $I_{OUT} = 200mA$	-7.5	-	8	%
	Output voltage at no load	V_{IN} nominal	-	5.5	-	V
	Output voltage ripple & noise	V_{IN} nominal, $V_{OUT} = 5V$ 20MHz BWL	-	55	-	mV _{PP}
Switching Frequency						
f_{SW}	Switching frequency	$V_{IN} = 3.3V$, $I_{OUT} =$ $200mA$ (1779205011)	-	600	-	kHz
		$V_{IN} = 5V$, $I_{OUT} = 200mA$ (1779205111)	-	300	-	kHz
		$V_{IN} = 12V$, $I_{OUT} = 200mA$ (1779205211)	-	600	-	kHz
		$V_{IN} = 24V$, $I_{OUT} = 200mA$ (1779205311)	-	600	-	kHz
Input Current						
I_{IN}	No load input current (operating, switching)	$V_{IN} = 3.3V$, $I_{OUT} = 0mA$ (1779205111)	-	11	-	mA
		$V_{IN} = 5V$, $I_{OUT} = 0mA$ (1779205111)	-	11	-	mA
		$V_{IN} = 12V$, $I_{OUT} = 0mA$ (1779205211)	-	3	-	mA
		$V_{IN} = 24V$, $I_{OUT} = 0mA$ (1779205311)	-	3	-	mA
Efficiency						
η	Efficiency	$V_{IN} = 3.3V$, $I_{OUT} = 200mA$ (1779205011)	-	83	-	%
		$V_{IN} = 5V$, $I_{OUT} = 200mA$ (1779205111)	-	85	-	%
		$V_{IN} = 12V$, $I_{OUT} = 200mA$ (1779205211)	-	85	-	%
		$V_{IN} = 24V$, $I_{OUT} = 200mA$ (1779205311)	-	82	-	%
Isolation Characteristics						
C_{ISO}	Isolation capacitance	100kHz/0.1V	-	20	-	pF
R_{ISO}	Isolation resistance	500VDC	1	-	-	GΩ

All parameters are specified after 5 minutes run-in time unless otherwise noted.

PACKAGE SPECIFICATIONS

ITEM	PARAMETER	TYP ⁽³⁾	UNIT
Case	UL94V-0 (Refer to UL approval E150608)	-	-
φ (RH)	Operating humidity	5-95	%
Weight		1.3	g
Vibration	MIL-STD-202G: 5g for 1 minute, 120 cycles each of 3 orientation, test from 10Hz-55Hz		
IP	Degree of protection according to IEC/EC 60529	X0	
Washing	Washing compatible with standard industrial water based washers.		

RELIABILITY

SYMBOL	PARAMETER	TEST CONDITIONS	TYP ⁽³⁾	UNIT
MTBF ⁽⁹⁾	Mean Time Between Failures	+25 °C: Ground Benign	5200 · 10 ³	h
		+100 °C: Ground Benign	950 · 10 ³	h

ISOLATION VOLTAGE

To verify the integrity of the isolation a test voltage is applied for a specified time across a component that is designed to provide electrical isolation. This test is known as a 'High Pot Test', 'Flash Tested', 'Withstand Voltage', 'Proof Voltage', 'Dielectric Withstand Voltage' & 'Isolation Test Voltage'.

All isolated Power Modules are 100% production tested at their stated isolation voltage. This is 1.5kVDC for 60 seconds.

The isolation test voltage indicated in this data sheet is for voltage transient immunity only. It does not allow this part to be used within a safety isolation system.

The module will function properly with several hundreds of volts applied continuously across the isolation barrier, however surrounding components must be individually analyzed to ensure proper insulation. Isolation measures must be taken in to account to prevent any user-accessible circuitry from causing harm.

DIELECTRIC TEST SETUP (HIGH POT TEST)

Connect all input and output terminals together (see figure below) before connecting the supply voltage. When testing, set the cut-off current to 1mA.

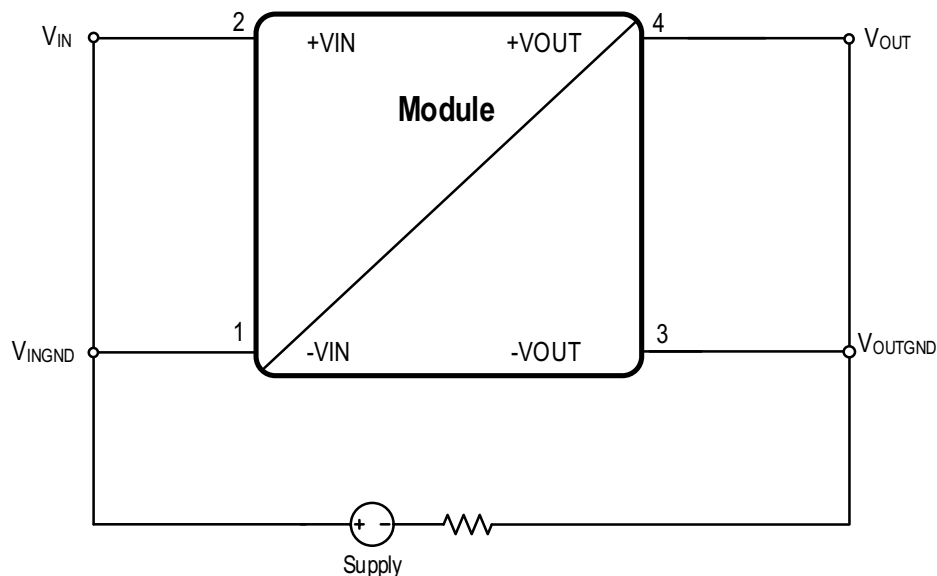

Parameters Supply Device: Current limit set 1mA, test voltage 1500 VDC, test time 60s.

REPEATED HIGH-VOLTAGE ISOLATION TESTING

A repeated high voltage test of a barrier component degrades its isolation capabilities.

The primary and secondary windings within this transformer are enameled (coated) but do not possess additional isolation. Typically, parts can withstand multiples of their stated test voltage and still perform optimally. The magnet wire coating can degrade over time due to chemical reactions that occur at high voltages. We recommend keeping high voltage isolation testing to a minimum to better protect the isolation between the windings. If repeated high voltage isolation testing is required, consider reducing the voltage by a significant amount e.g. 20% from the test voltage stated within the datasheet

These safety concerns are equally applicable to components that utilize functional isolation beyond wire coating (i.e. physical barriers or spacing).

APPROVALS

SYMBOL	STANDARD	DESCRIPTION
	62368-1, 2 nd Edition	Recognized for use as Audio/Video, Information and Communication Technology Equipment, U.S.A. (UL62368-1) and Canada (C22.2 No. 62368-1) E-File: E497615 Applicable for altitudes up to 2000m

RoHS, REACH

RoHS directive		Directive 2011/65/EU of the European Parliament and the Council of June 8th, 2011 on the restriction of the use of certain hazardous substances in electrical and electronic equipment.
REACH directive		Directive 1907/2006/EU of the European Parliament and the Council of June 1st, 2007 regarding the Registration, Evaluation, Authorization and Restriction of Chemicals (REACH).

NOTES

- (1) Min and Max limits are 100% production tested at 25°C. Limits over the operating temperature range are guaranteed through correlation using Statistical Quality Control (SQC) methods.
- (2) Test voltage as defined by the UL62368-1.
- (3) Typical numbers are valid at 25°C ambient temperature and represent statistically the utmost probability assuming the Gaussian distribution.
- (4) Depending on temperature, see thermal derating diagram ([OUTPUT POWER](#)).
- (5) Measured without heatsink, still air. (0 - 20LFM / 0 - 0.1 m/s) Test PCB 80mmx80mm horizontal orientation 35µm copper on top and bottom.
- (6) Not production tested. It is a design parameter.
- (7) Overload current, see [I_{MOC} DUTY CYCLE & I_{MOC} TEMPERATURE DERATING](#).
- (8) Within the complete V_{IN} tolerance range.
- (9) MIL-HDBK-217F; GB Ground, Benign: Non mobile, temperature and humidity controlled environments readily accessible to maintenance; includes laboratory instruments and test equipment, medical electronic equipment, business and scientific computer complexes, and missiles and support equipment in ground silos; MTBF value is referring to 1779205x11.
- (10) The human body model is a 100pF capacitor discharged through a 1.5 kΩ resistor into each pin. Test method is per JESD-22-114.

TYPICAL PERFORMANCE CURVES

If not otherwise specified, the following conditions apply: $T_A = 25^\circ\text{C}$.

RADIATED AND CONDUCTED EMISSIONS (WITH EMI INPUT FILTER)

The 1779205x11 power modules were tested in several EMC configurations to give more realistic information about implementation in the applications. The test setup is based on CISPR16 with the limit values of CISPR32.

RADIATED EMISSIONS EN55032 (CISPR-32) CLASS B COMPLIANT TEST SETUP

- Measured with layout shown in [DESIGN EXAMPLE](#) in a Fully Anechoic Room (FAR) at 3m antenna distance.
- Measurement input wire length: 160cm (80cm horizontal + 80cm vertical)
- Output wire length: 1m

CONDUCTED EMISSIONS EN55032 (CISPR-32) CLASS B COMPLIANT TEST SETUP

- Measurement input wire length: 80cm
- Output wire length: 1m

RADIATED AND CONDUCTED EMISSIONS - 1779205011

Radiated Emissions 1779205111 (3m Antenna Distance)
 $V_{IN} = 5V$, $V_{OUT} = 5V$, $I_{LOAD} = 0.2A$ with input filter
 C_F and $C_{IN} = 4.7\mu F$ (885012209048), $L_F = 1\mu H$ (7447730), $C_{OUT} = 10\mu F$
 (885012109009), $C_V = 1nF$ (885342210001)
Horizontal Vertical

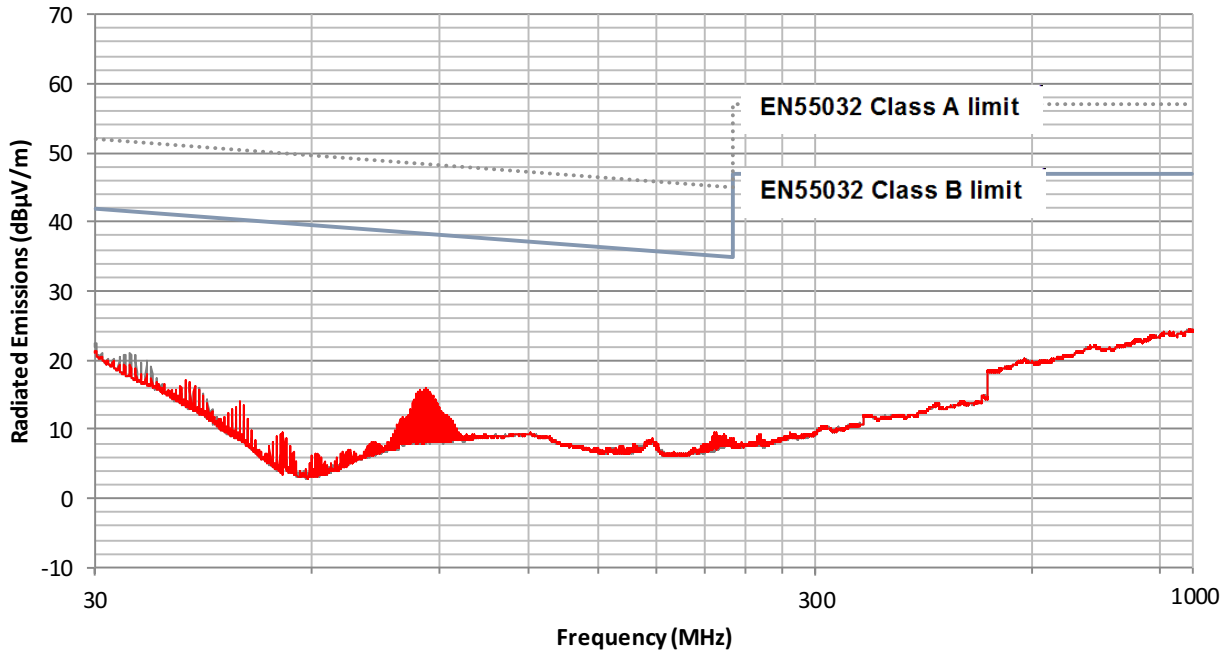

Conducted Emissions 1779205111
 $V_{IN} = 5V$, $V_{OUT} = 5V$, $I_{LOAD} = 0.2A$ with input filter
 C_F and $C_{IN} = 4.7\mu F$ (885012209048), $L_F = 1\mu H$ (7447730), $C_{OUT} = 10\mu F$
 (885012109009), $C_V = 1nF$ (885342210001)
Average Quasi peak

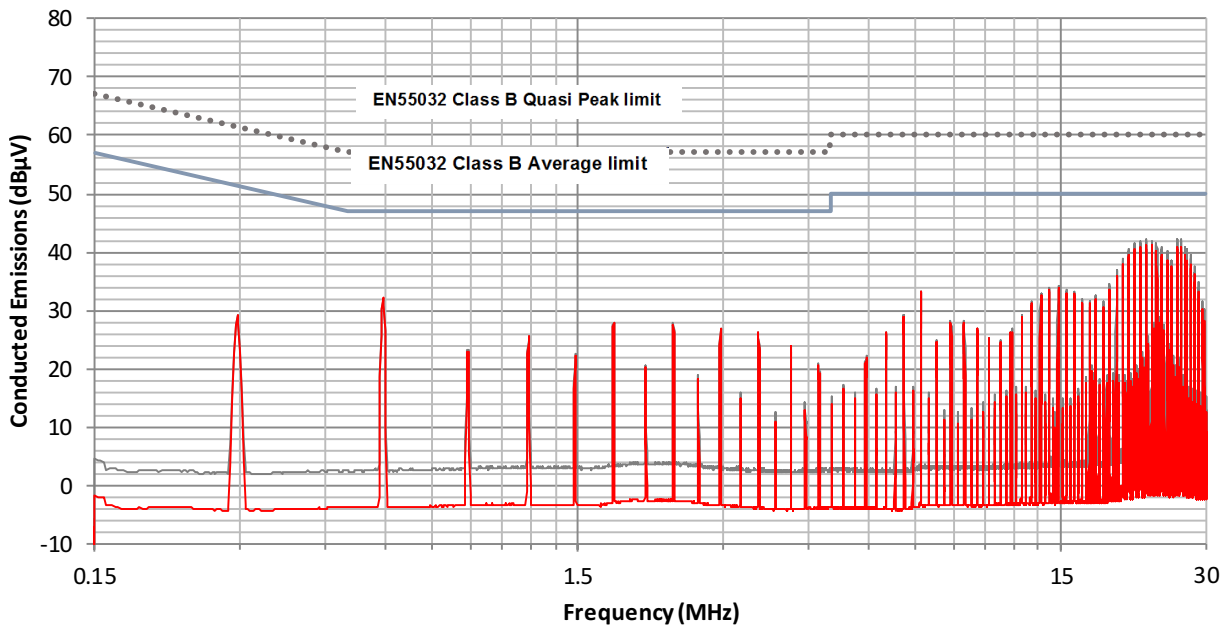

RADIATED AND CONDUCTED EMISSIONS - 1779205111

Radiated Emissions 1779205111 (3m Antenna Distance)
 $V_{IN} = 5V$, $V_{OUT} = 5V$, $I_{LOAD} = 0.2A$ with input filter
 C_F and $C_{IN} = 4.7\mu F$ (885012209048), $L_F = 1\mu H$ (7447730), $C_{OUT} = 10\mu F$
 (885012109009), $C_V = 1nF$ (885342210001)
Horizontal Vertical

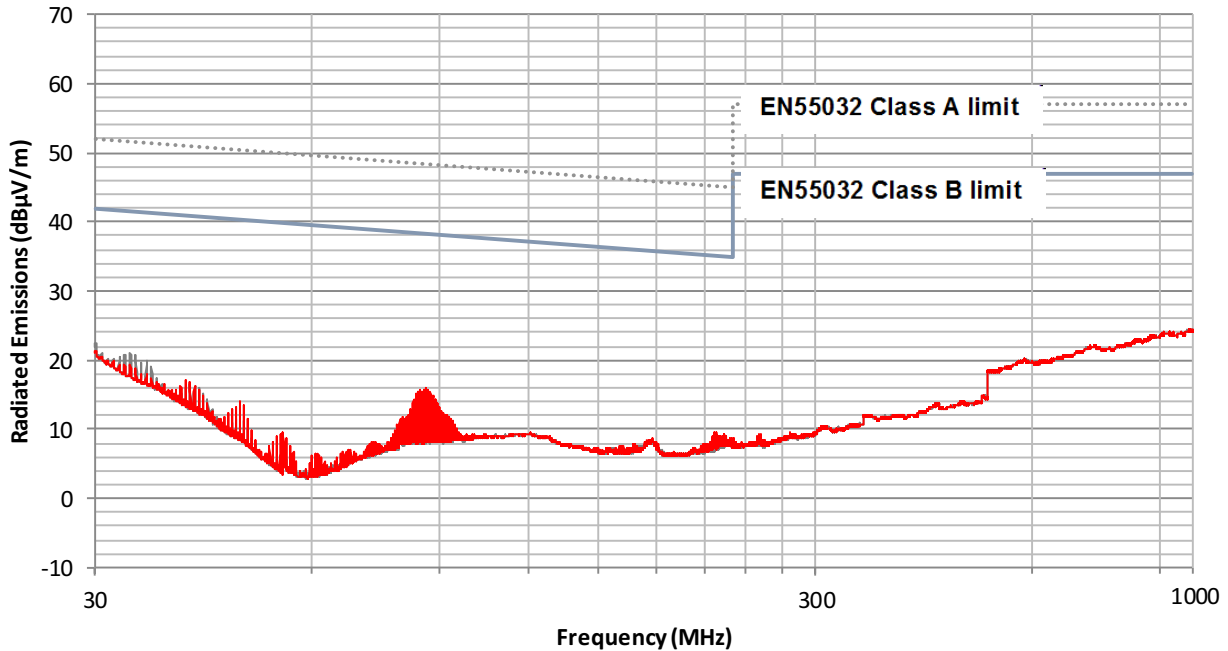

Conducted Emissions 1779205111
 $V_{IN} = 5V$, $V_{OUT} = 5V$, $I_{LOAD} = 0.2A$ with input filter
 C_F and $C_{IN} = 4.7\mu F$ (885012209048), $L_F = 1\mu H$ (7447730), $C_{OUT} = 10\mu F$
 (885012109009), $C_V = 1nF$ (885342210001)
Average Quasi peak

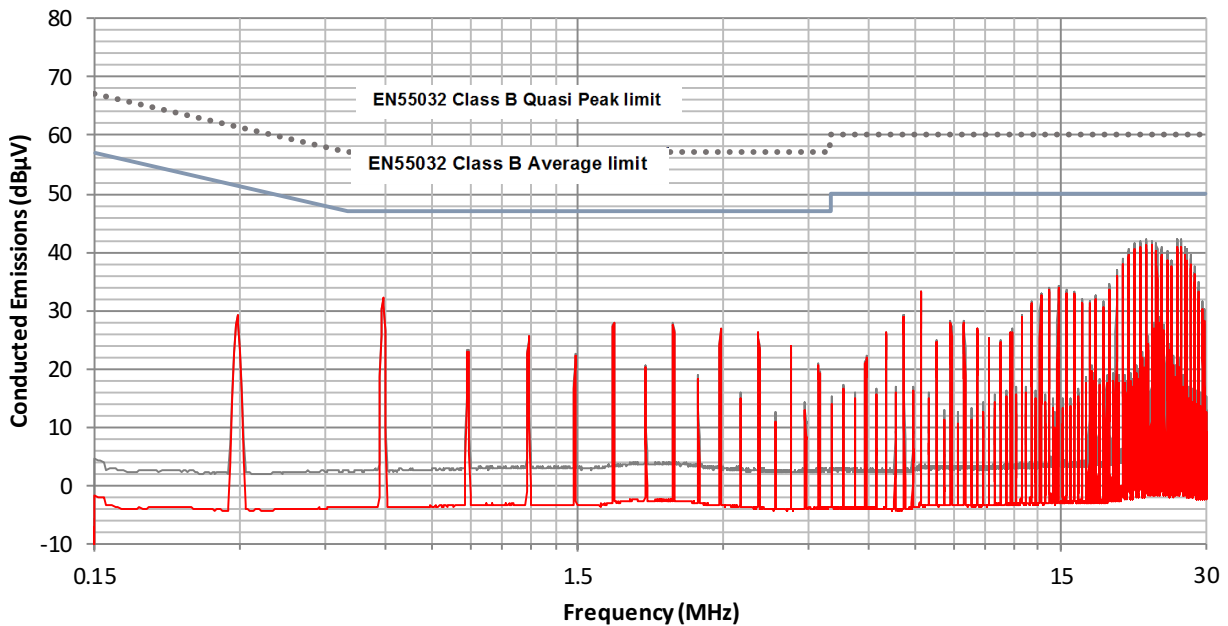

RADIATED AND CONDUCTED EMISSIONS - 1779205211

Radiated Emissions 1779205211 (3m Antenna Distance)
 $V_{IN} = 12V$, $V_{OUT} = 5V$, $I_{LOAD} = 0.2A$ with input filter
 C_F and $C_{IN} = 4.7\mu F$ (885012209048), $L_F = 1\mu H$ (7447730), $C_{OUT} = 10\mu F$
 (885012109009), $C_Y = 1nF$ (885342210001)
Horizontal **Vertical**

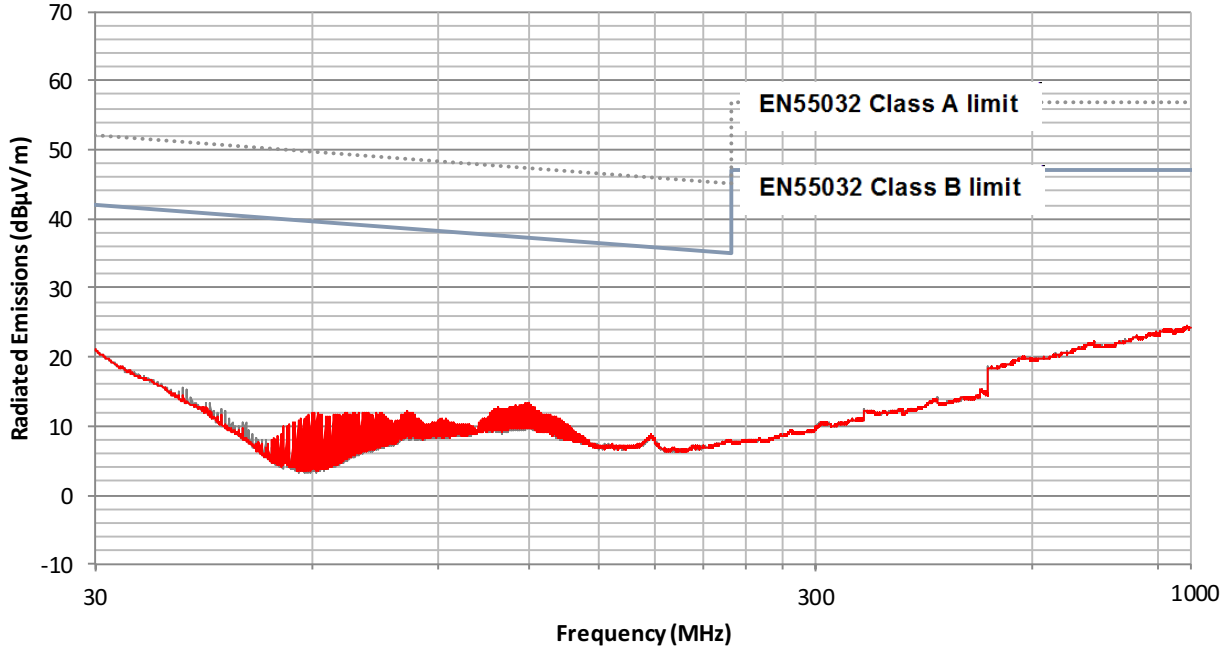

Conducted Emissions 1779205211
 $V_{IN} = 12V$, $V_{OUT} = 5V$, $I_{LOAD} = 0.2A$ with input filter
 C_F and $C_{IN} = 4.7\mu F$ (885012209048), $L_F = 1\mu H$ (7447730), $C_{OUT} = 10\mu F$
 (885012109009), $C_Y = 1nF$ (885342210001)
Average **Quasi peak**

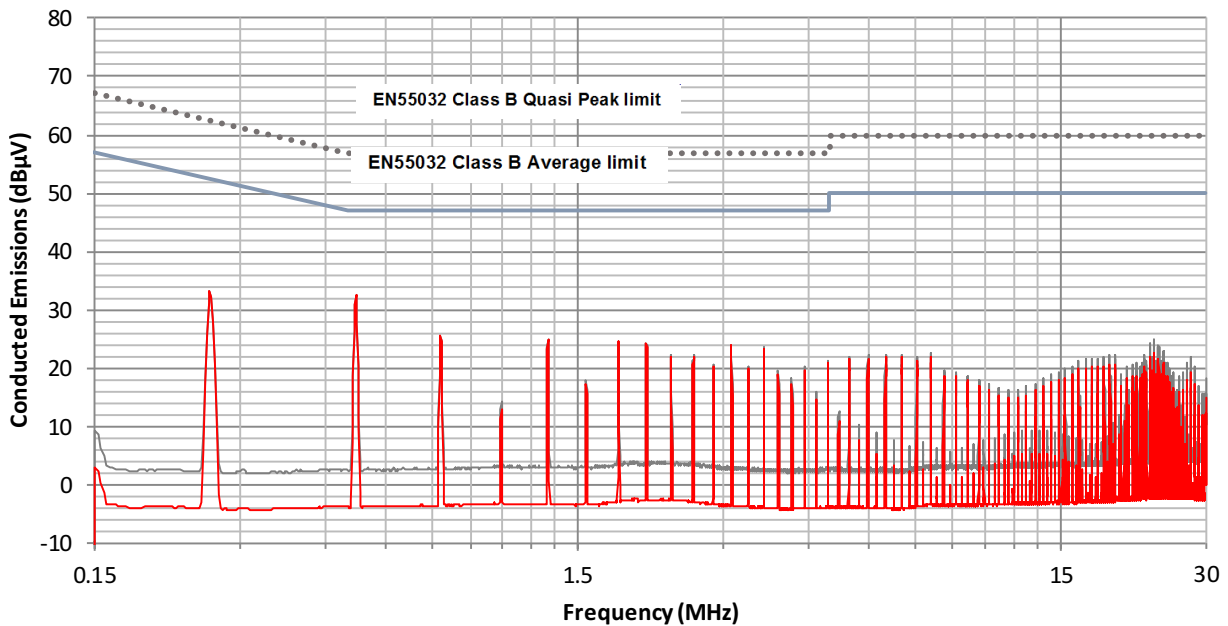

RADIATED AND CONDUCTED EMISSIONS - 1779205311

Radiated Emissions 1779205311 (3m Antenna Distance)

$V_{IN} = 24V$, $V_{OUT} = 5V$, $I_{LOAD} = 0.2A$ with input filter
 C_F and $C_{IN} = 4.7\mu F$ (885012209048), $L_F = 1\mu H$ (7447730), $C_{OUT} = 10\mu F$
 (885012109009), $C_Y = 1nF$ (885342210001)

Horizontal Vertical

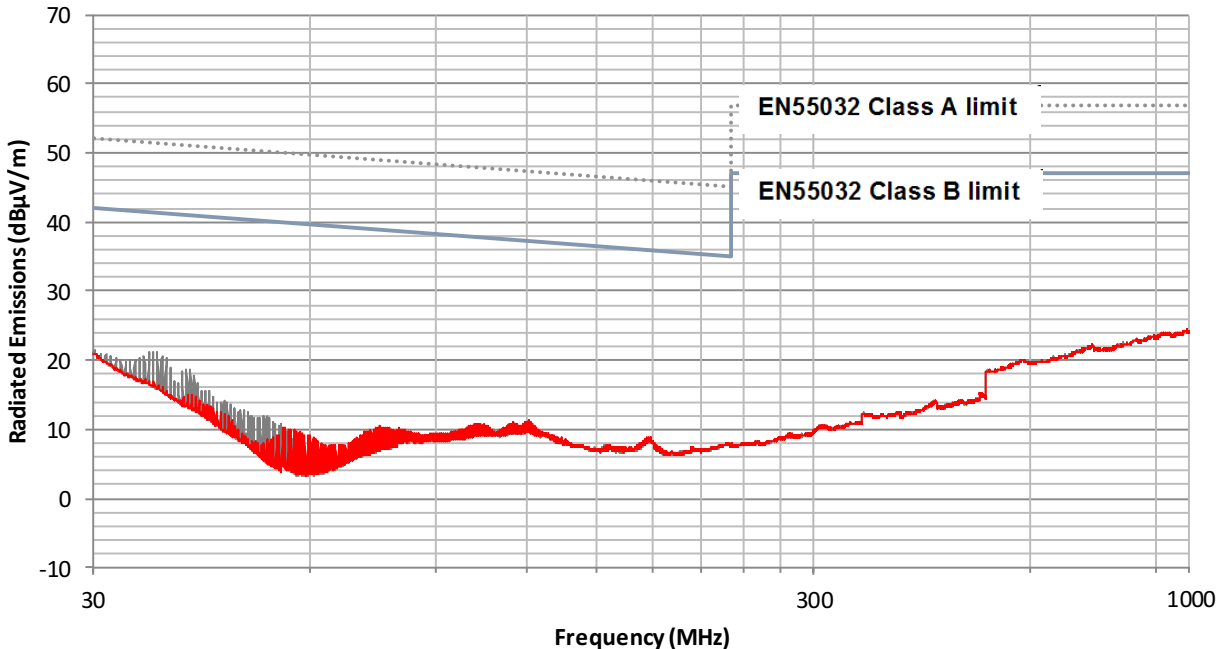

Conducted Emissions 1779205311

$V_{IN} = 24V$, $V_{OUT} = 5V$, $I_{LOAD} = 0.2A$ with input filter
 C_F and $C_{IN} = 4.7\mu F$ (885012209048), $L_F = 1\mu H$ (7447730), $C_{OUT} = 10\mu F$
 (885012109009), $C_Y = 1nF$ (885342210001)

Average Quasi peak

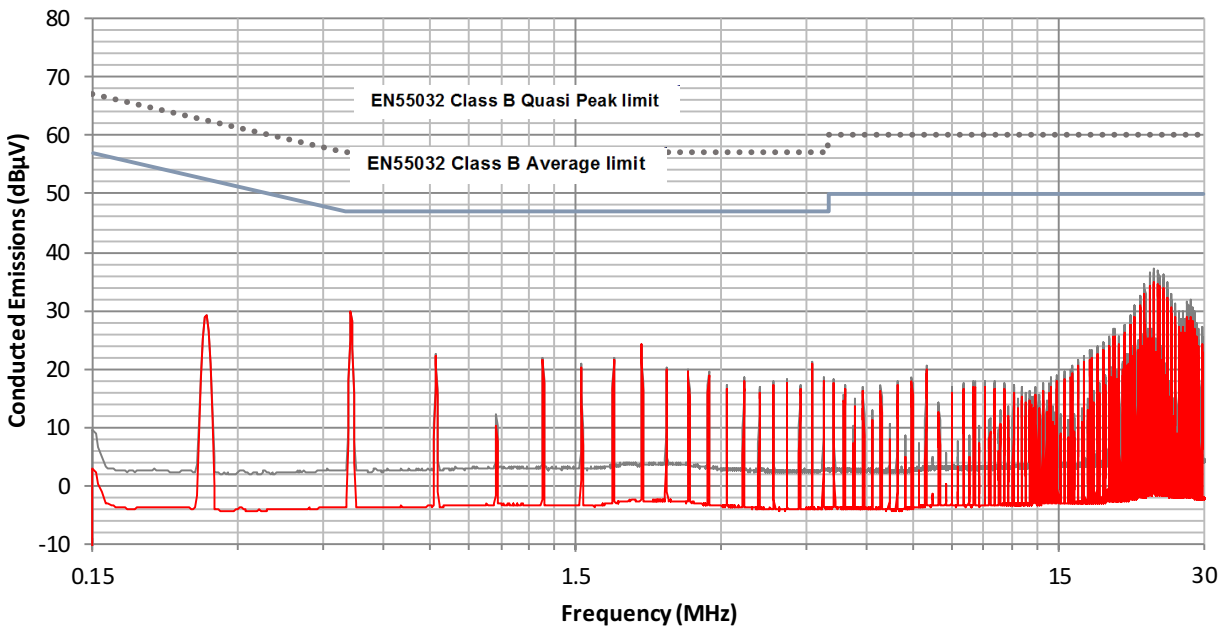

EFFICIENCY

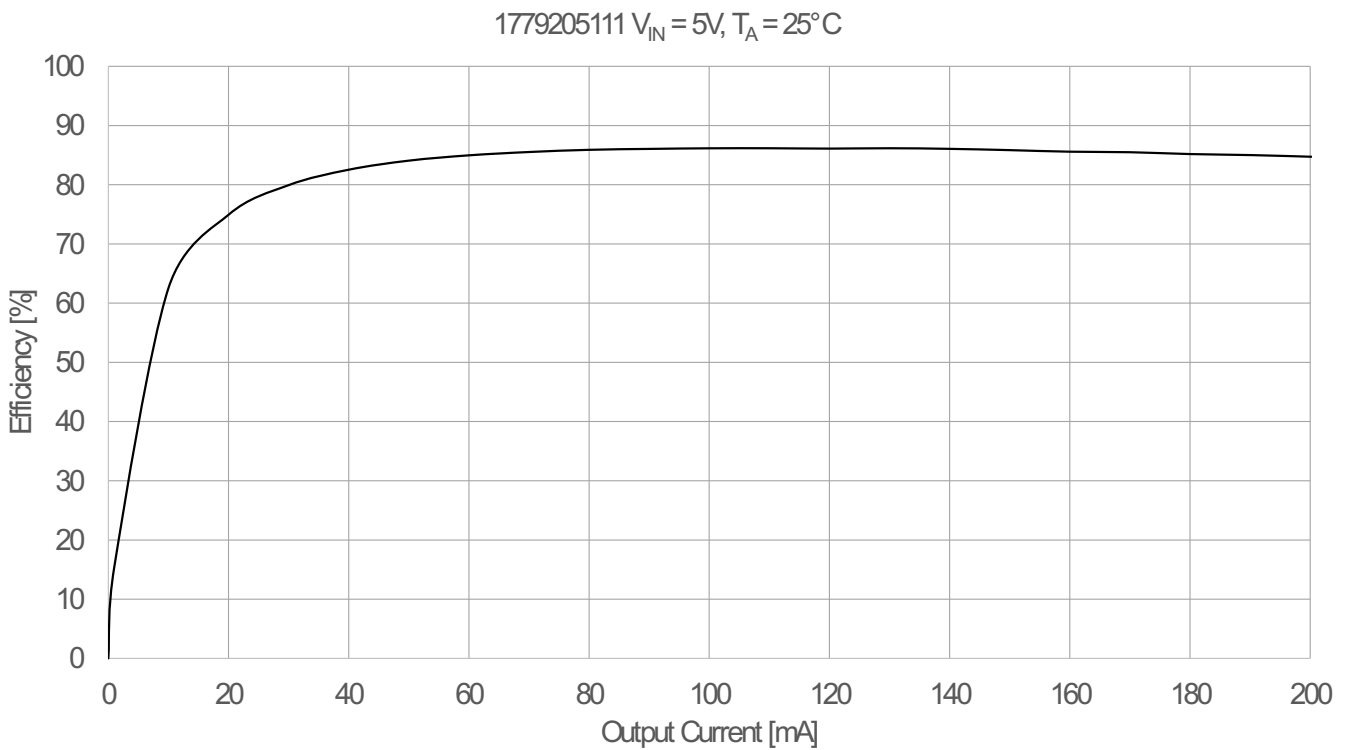
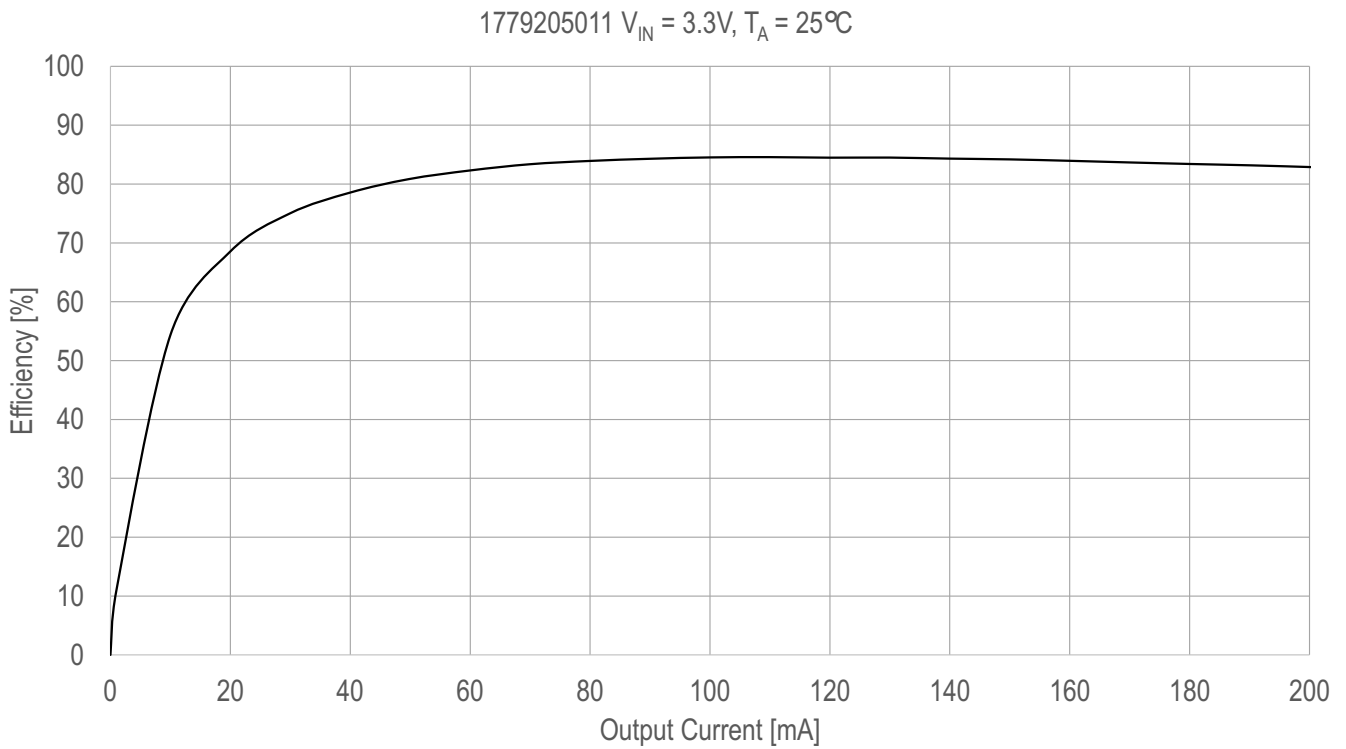

1779205211 $V_{IN} = 12V$, $T_A = 25^\circ C$

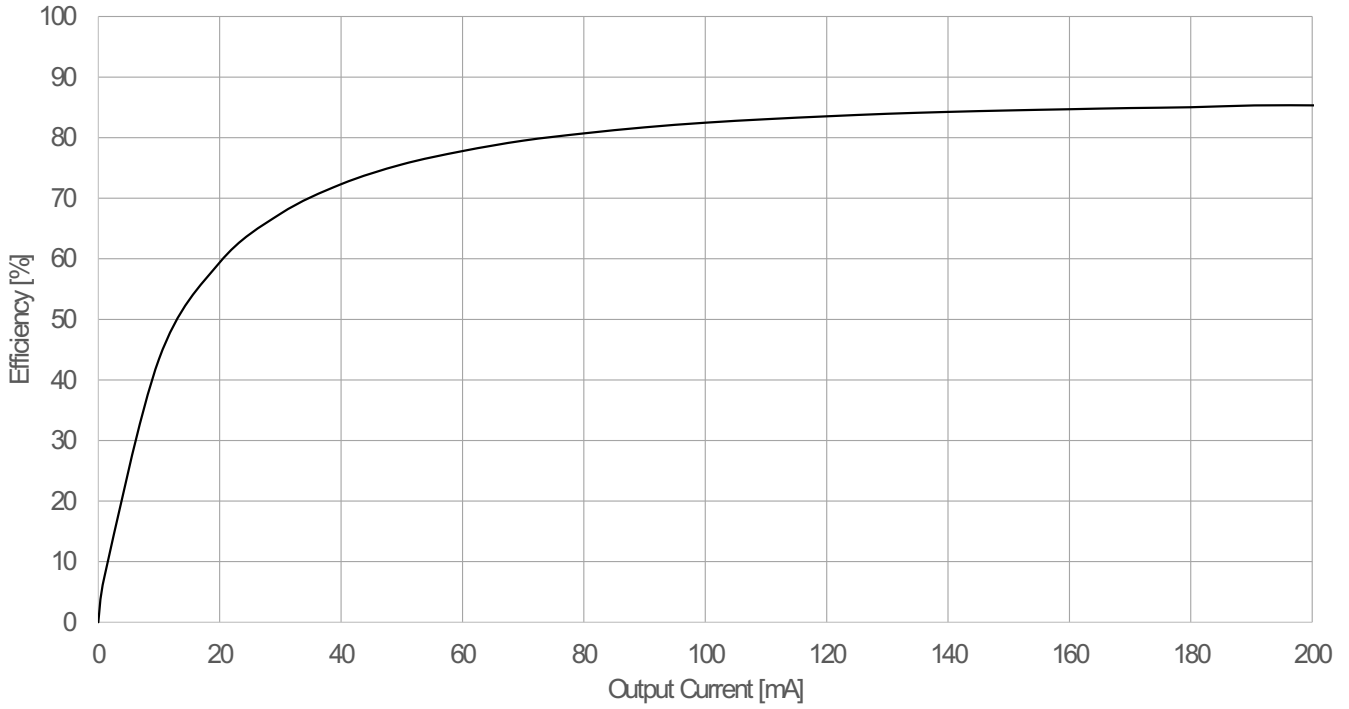

1779205311 $V_{IN} = 24V$, $T_A = 25^\circ C$

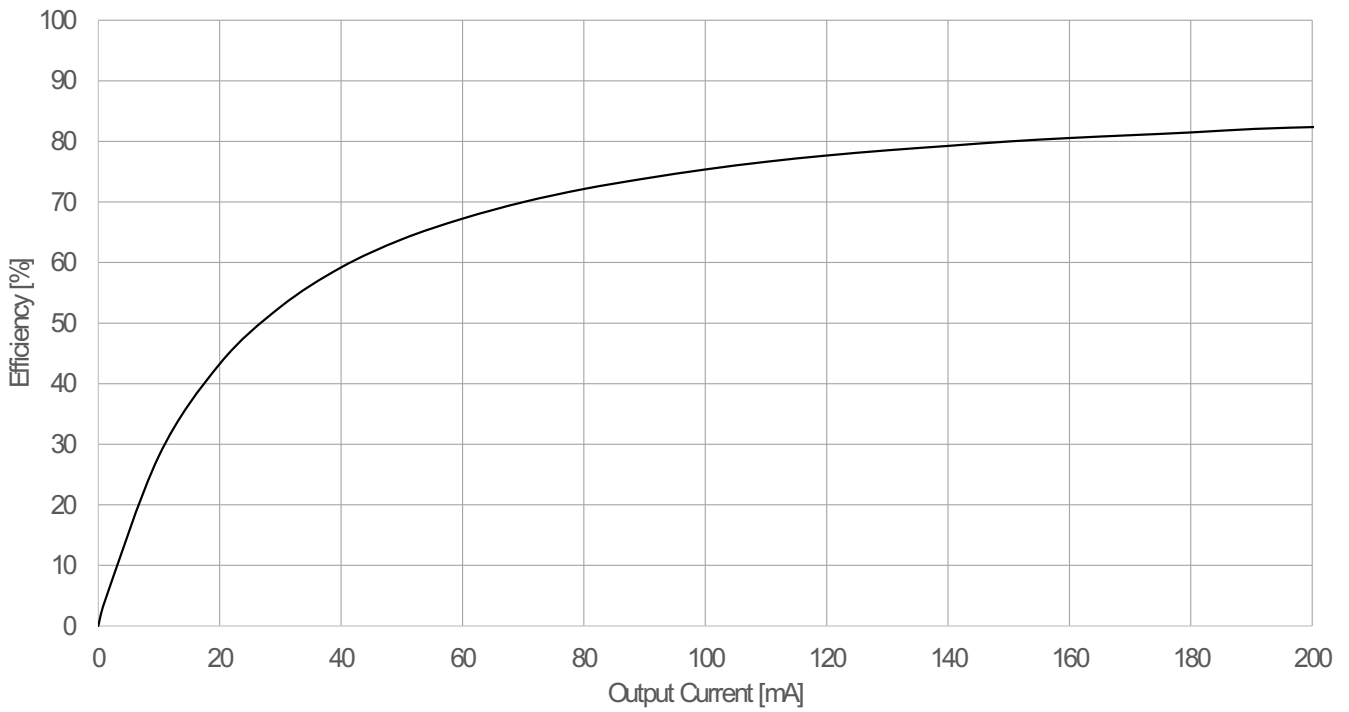

OUTPUT POWER

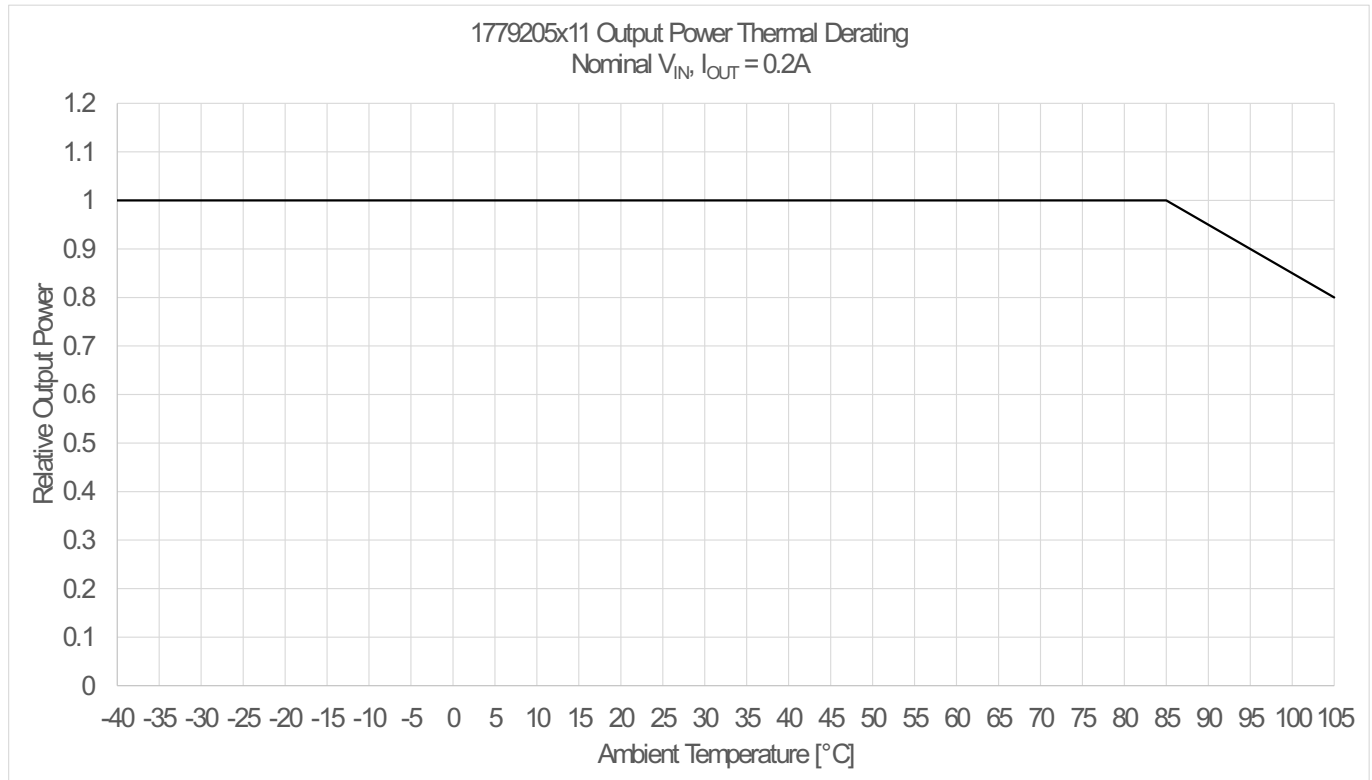

DUTY CYCLE I_{MOC}

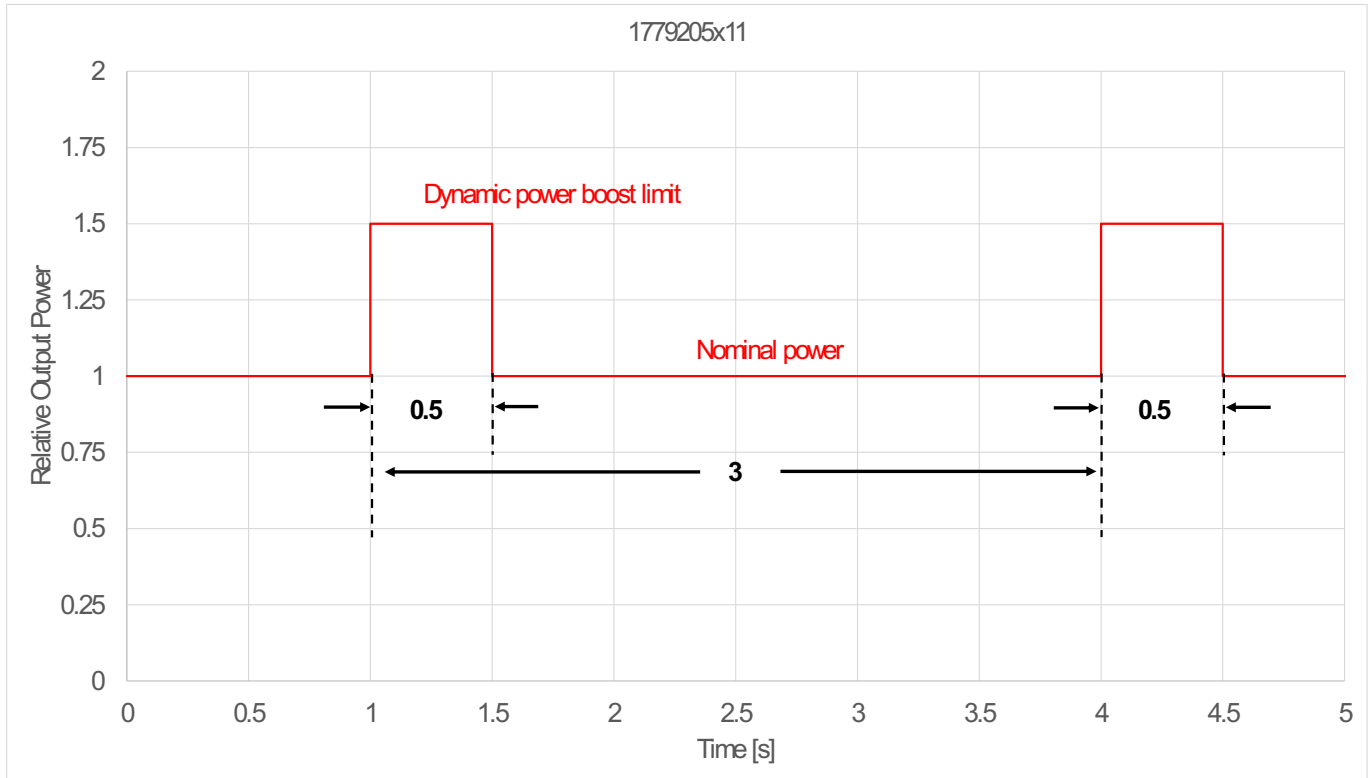

Note: The overload current of 150% I_{OUT} can be supplied for maximum 0.5s and requires a 3s recovery time till next overload event.

TEMPERATURE DERATING I_{MOC}

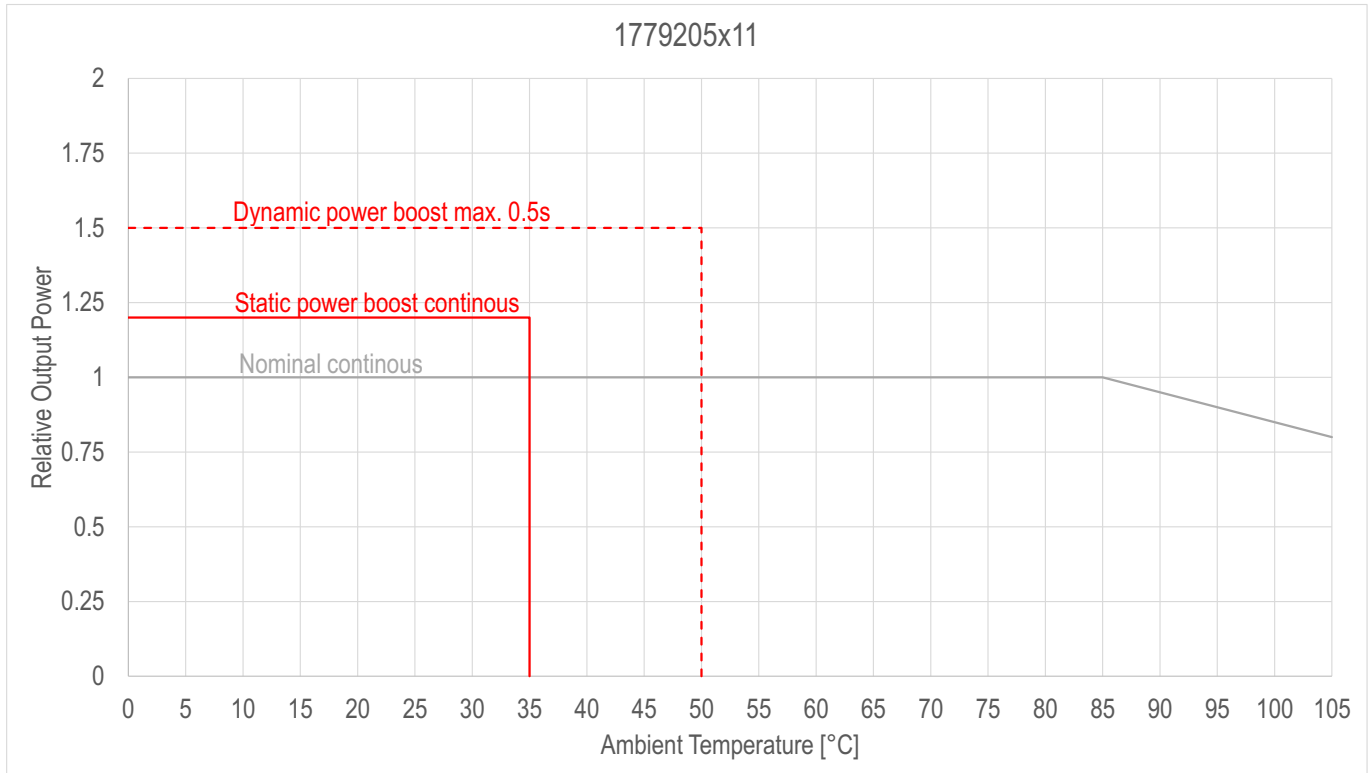

Note: Still air (0 - 20LFM / 0 - 0.1m/s), output power values are shown as relative power values

OUTPUT VOLTAGE TOLERANCE ENVELOPE

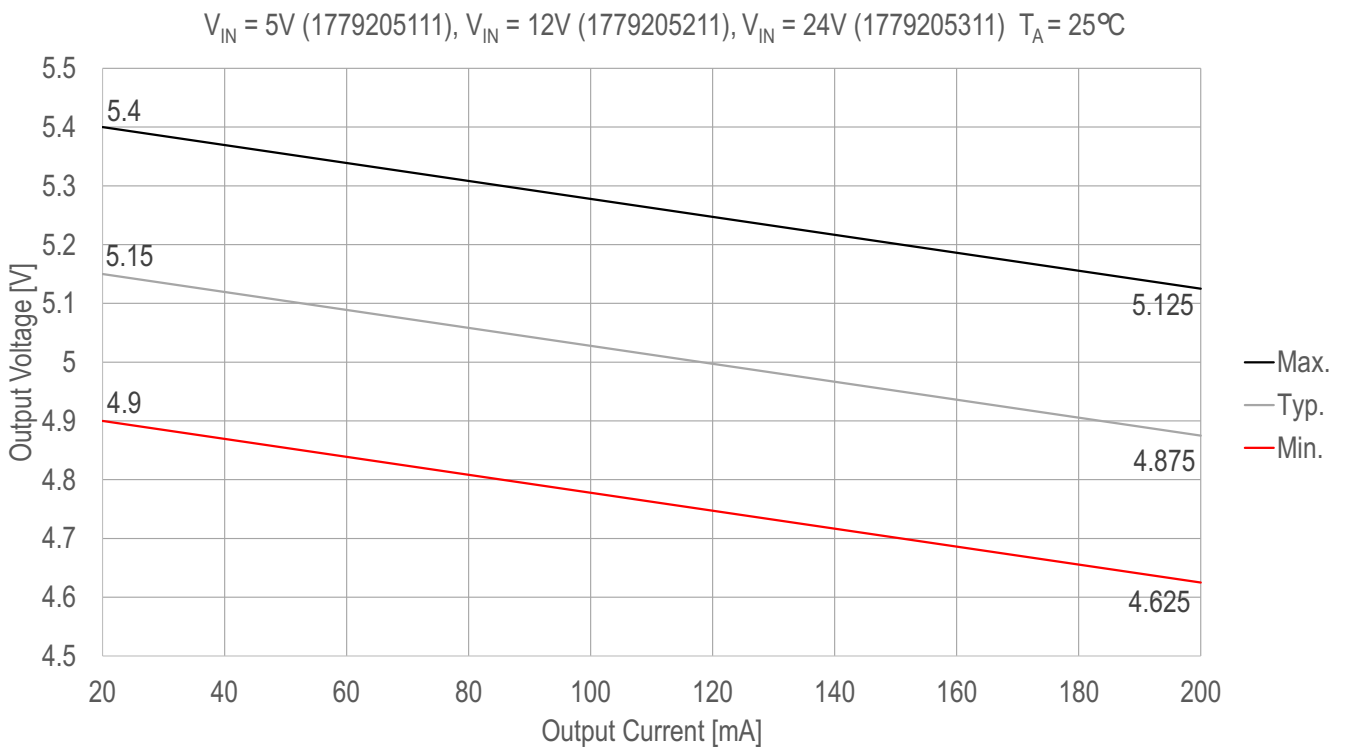
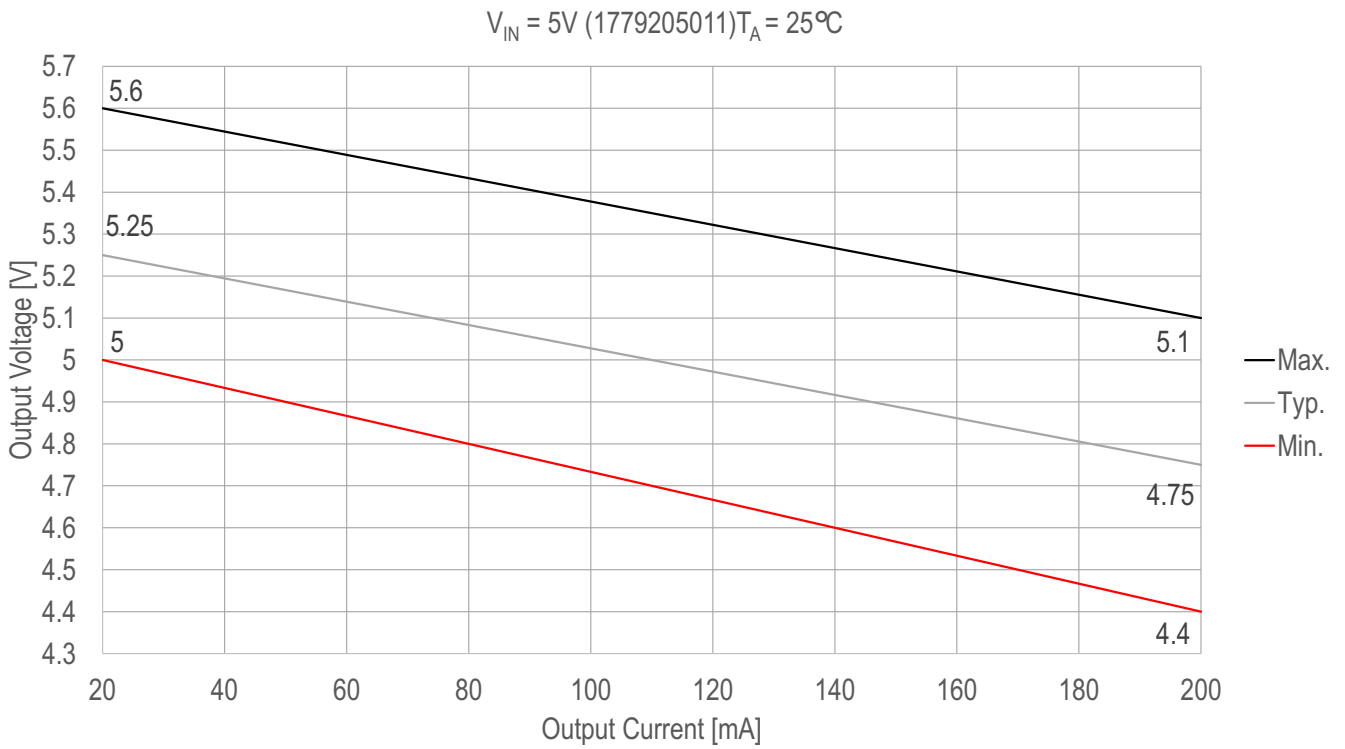

BLOCK DIAGRAM

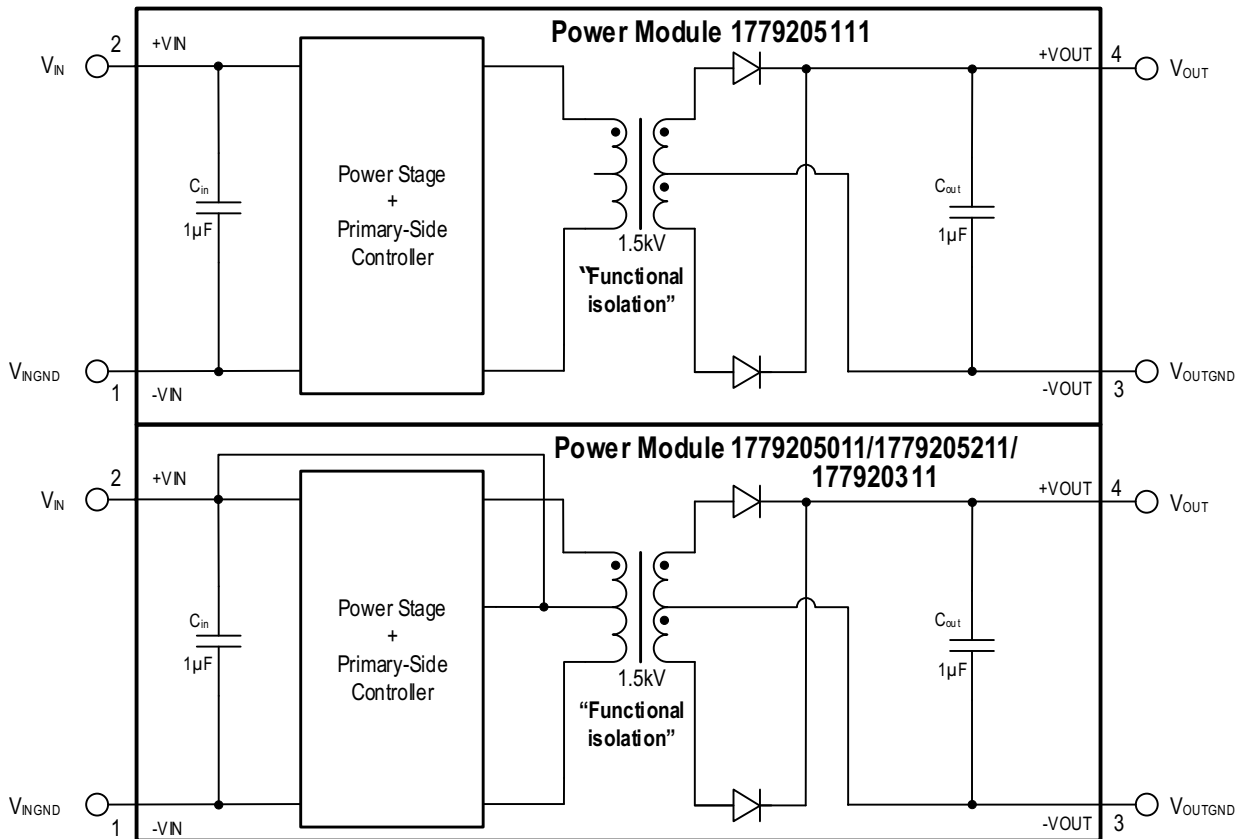

CIRCUIT DESCRIPTION

The MagI³C power module 1779205111 is based on full bridge topology whereas the MagI³C power modules 1779205011 / 1779205211 / 1779205311 are based on a push-pull converter. All modules have an integrated IC, rectifying diodes, input and output capacitors and a transformer.

Since there is no feedback path from the output to the input, the duty cycle is fixed at 50% and is independent of the load (zero load to full load). The output voltage is unregulated and defined by the turns ratio of the transformer.

PROTECTIVE FEATURES

Due to the structure of the 1779205x11 MagI³C power modules, the following protective features are **NOT** implemented:

- Over temperature protection (OTP)
- Overcurrent protection (OCP)
- Output overvoltage protection (OVP)
- Input overvoltage protection
- Input reverse polarity protection

Note: To protect the source and the MagI³C power module in abnormal conditions (e.g. secondary side overload or short circuit) a primary side input fuse (slow blow) is recommended.

Short-Circuit Protection (SCP)

The modules are continuously output short-circuit protected. The protection is realized via comparing the drain voltages of the MOSFETs to a certain internal reference. During a short circuit situation the output voltage is pulled low. The output voltage recovers to its nominal value after the error is resolved.

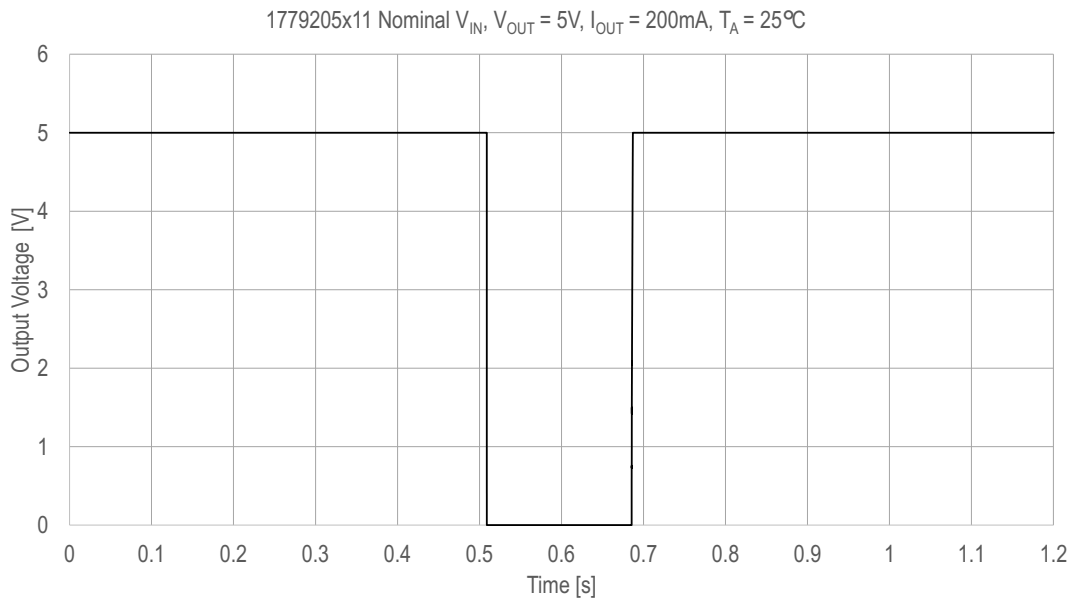

DESIGN EXAMPLE

Layout

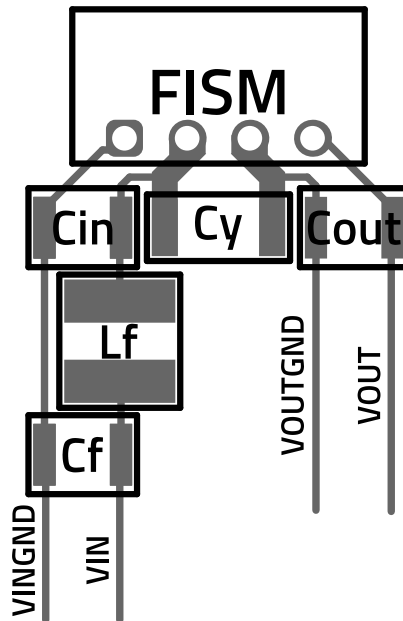

The layout above has been evaluated to provide the optimal performance in terms of transient response, efficiency, ripple and EMI. The design footprint can be reduced at the expense of performance in these parameters. The following recommendation should be followed when designing the layout:

1. The input capacitor should be placed as close as possible to the +VIN and -VIN pins of the device.
2. The output capacitor should be placed as close as possible to the +VOUT and -VOUT pins of the device.
3. The Y-capacitor should be placed as close as possible to the +VIN and -VOUT pins of the device.

Schematic

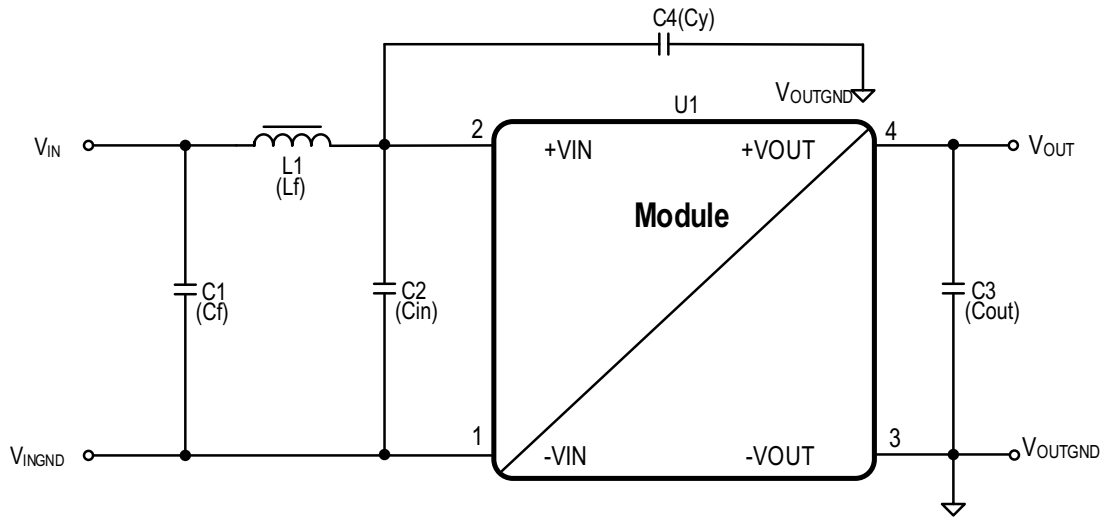

Bill of Materials

For optimal EMI performance, one filter capacitors, C1, one filter inductor, L1, one input capacitor, C2, one output capacitor, C3 and one Y-Cap, C4 are recommended. For optimal electrical performance, one input capacitor C2 and one output capacitor C3 are recommended.

Designator	Description	Function	Quantity	Order Code	Manufacturer
U1	MagI ³ C Power Module	Power supply	1	1779205x11	WE
L ₁	Filter inductor, 1μH, PD2 family, I _{SAT} = 5.72A, I _R = 4A	Input Filter	1	7447730	WE
C ₁	Ceramic chip capacitor 4.7μF/50V X7R, 1210	Input Filter	1	885012209048	WE
C ₂	Ceramic chip capacitor 4.7μF/50V X7R, 1210	Input Filter / Electrical Performance	1	885012209048	WE
C ₃	Ceramic chip capacitor 10μF/16V X7R, 1210	Output Filter / Electrical Performance	1	885012109009	WE
C ₄	Ceramic chip capacitor 1nF/2kV 1808 X7R	Y-Cap	1	885342210001	WE

TYPICAL APPLICATION

The figure below depicts a typical application for an isolated power module setup for isolated RS485 communication with the essential functional units.

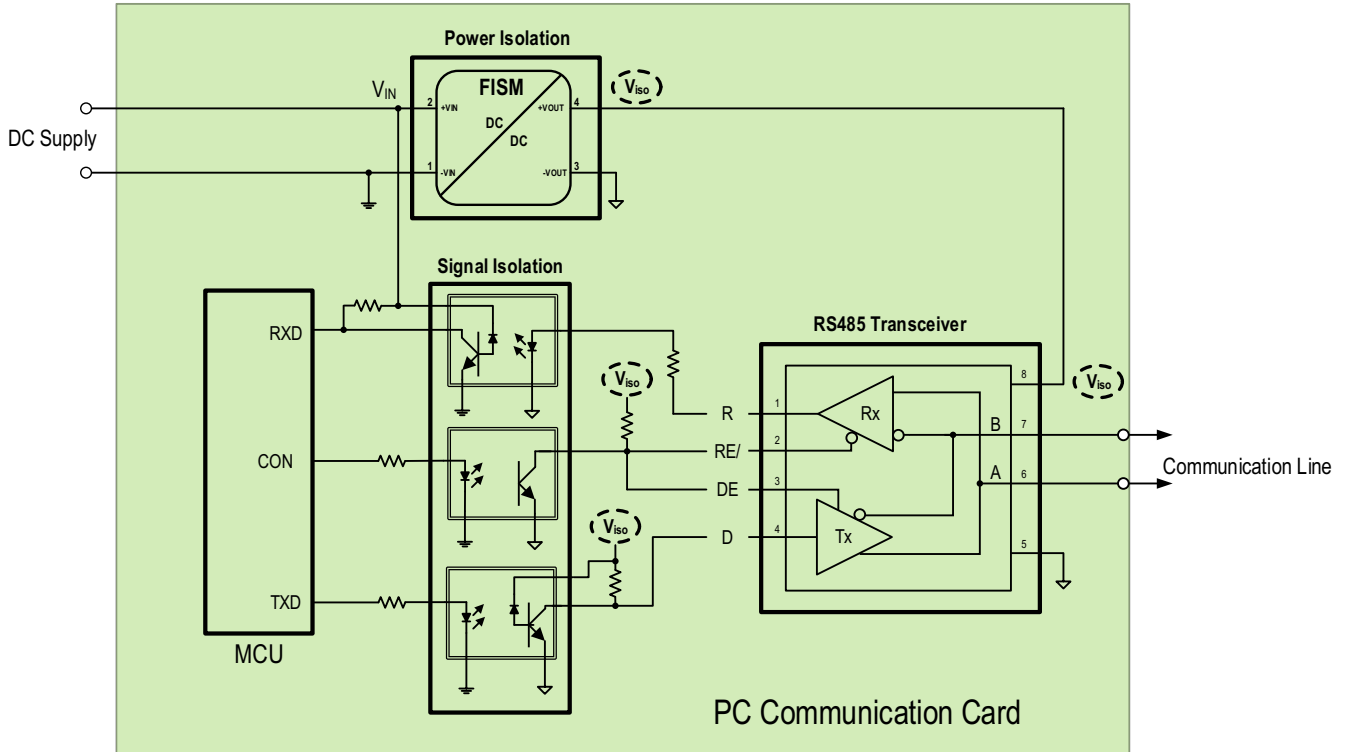

To set up an isolated communication, different functional units are required. The data for the RS485 transceiver is provided by the Micro Controller Unit (MCU), which in turn receives data from the RS485 transceiver. With the use of optocouplers the signal isolation unit can achieve galvanic isolation of the signals. A power isolation unit - a DC/DC converter power module - attains galvanic isolation of the grounds between the signal isolation unit and the transceiver unit.

The main benefit of galvanic power isolation is the prevention of faults than can propagate from the supply voltage through the bus and disturb signal lines.

APPLICATION CONSIDERATIONS

Primary side parallel connection

A standard industrial configuration is, that the power modules are supplied by a dc bus voltage. Multiple 1779205X11 can be connected to one dc bus as shown in the figure below.

The outputs must not be connected in parallel to each other and could have individual voltages V_{OUT1} and V_{OUT2} . For serial connection of the outputs see also "[Secondary side serial connection](#))".

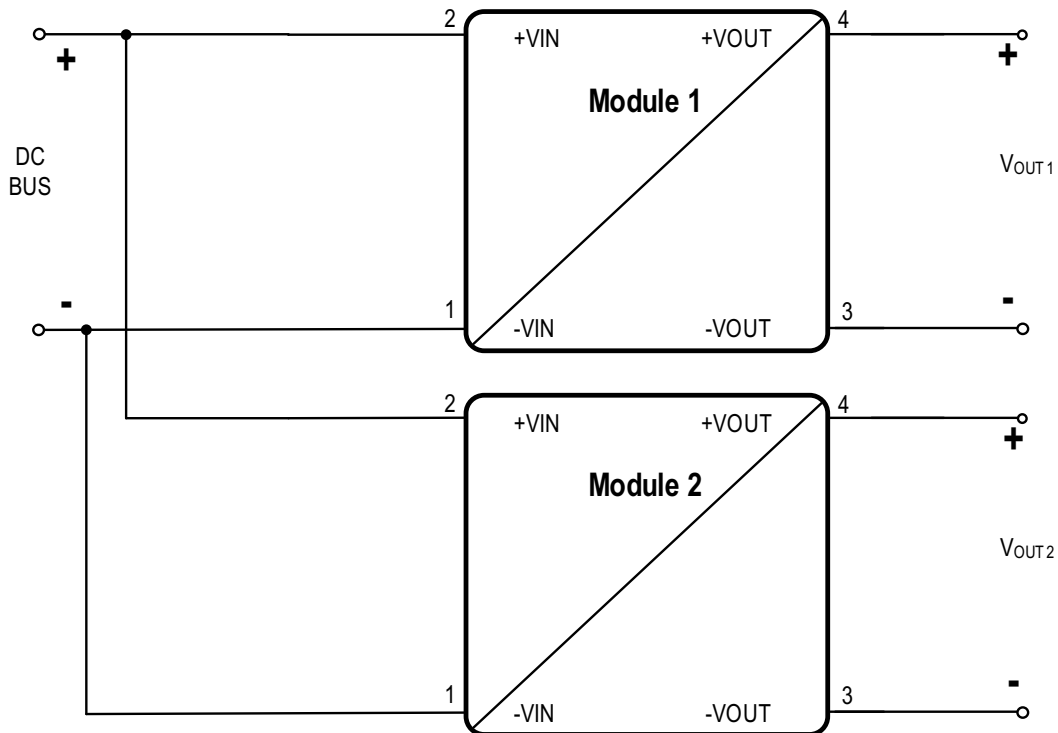

In case of using long supply lines or different wire length for each 1779205X11 it is recommended to decouple each power module with an additional LC filter (see schematic below). The decoupling LC filter is also recommended if the supplying dc bus has a high impedance so that high voltage swings at the input of each power module might be present.

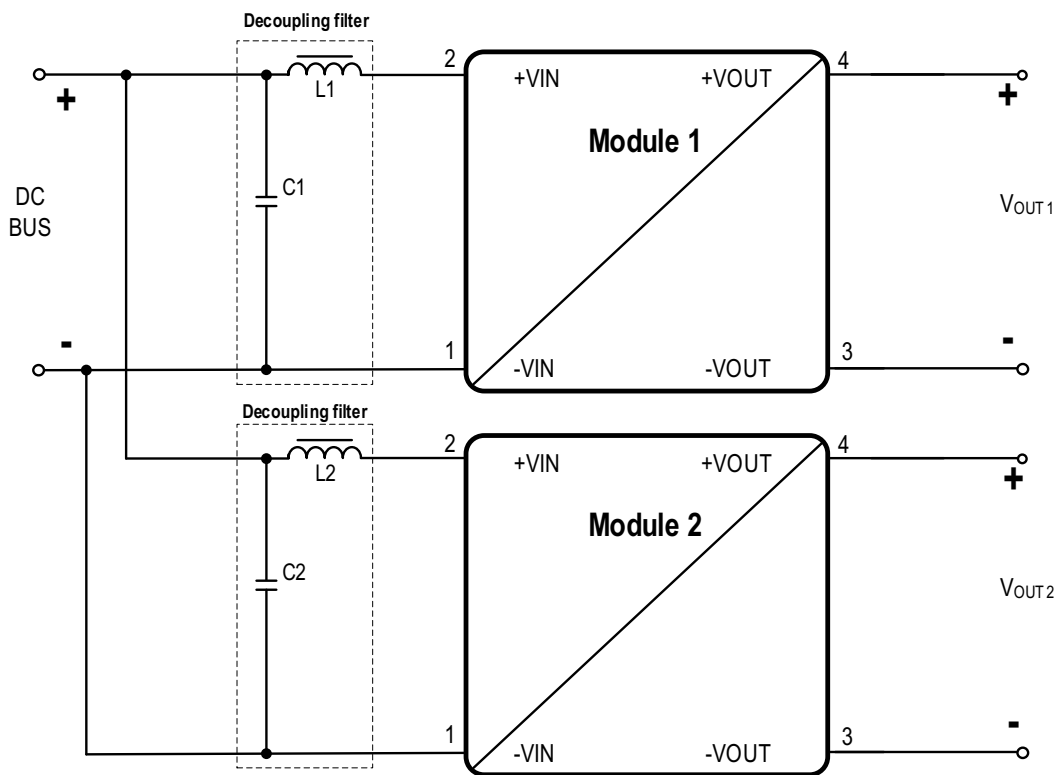

As a starting point for the decoupling filters, use the values of the reference filters - see also “[RADIATED AND CONDUCTED EMISSIONS \(WITH EMI INPUT FILTER\)](#)“. The final appropriate filter for the application has then to be evaluated under operation in the target application by checking e.g. the change of the input ripple voltage.

Secondary side serial connection

To generate higher output voltage/special rail voltages it is possible to put the outputs of the 1779205X11 in series. It is common practice to connect an additional capacitor between the +VOUT and -VOUT.

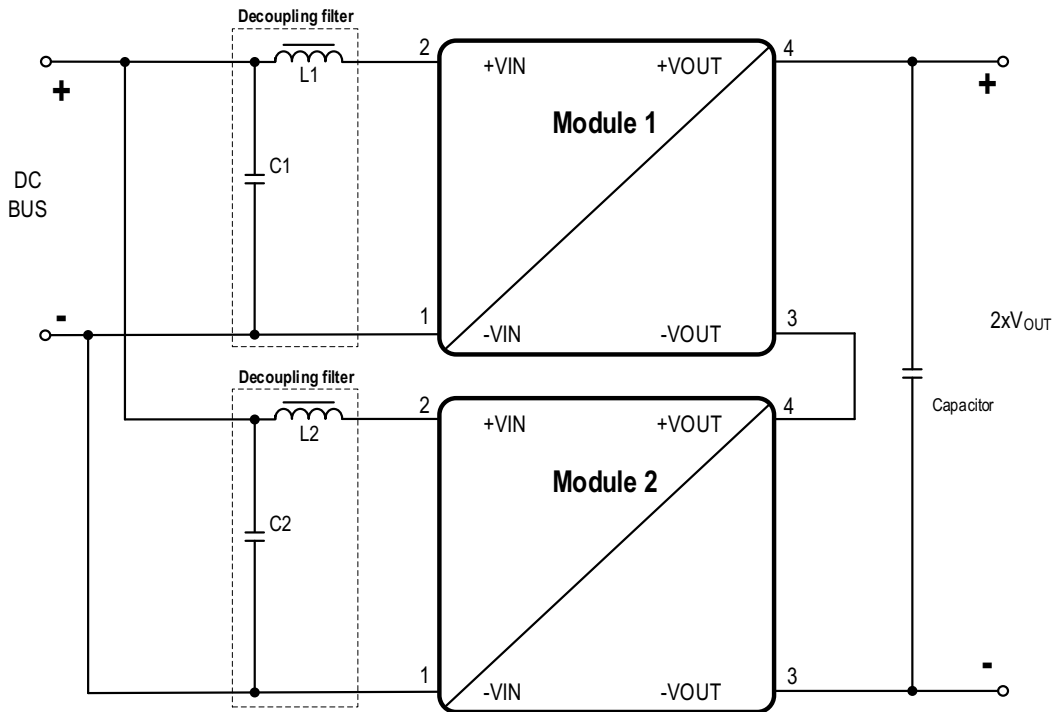

In case of using long supply lines or different line length for each 1779205X11 it is recommended to decouple each power module with an additional LC filter. The decoupling LC filter is also recommended if the supplying dc bus has a high impedance so that high voltage swings at the input of each power module could be present. As initial values, the EMI filter shown for every part number can be used. See also "[Primary side parallel connection](#)".

Generating complementary output voltages

Another common requirement in industrial applications is to provide a complementary voltage ($\pm 5V$). The circuit below shows how this target can be achieved simply by combining a 1779205X11 used in a standard configuration (delivering a positive output voltage) with a 1779205X11 in a reverse configuration. It is a common practice to connect an additional capacitor across each output voltage.

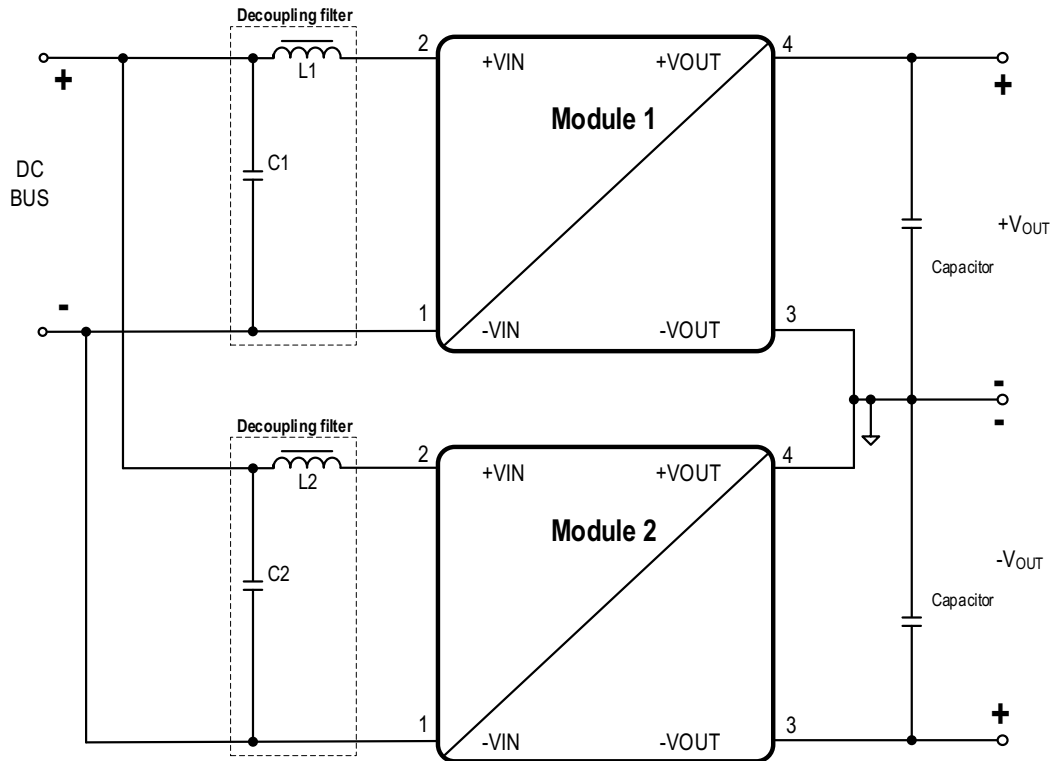

For using long supply lines or different line length for each 1779205X11 it is recommended to decouple each power module with an additional LC- filter. The decoupling LC-filter is also recommended if the supplying dc bus has a high impedance so that high voltage swings at the input of each power module could be present. As initial values, the EMI filter shown for every part number can be used. See also "[Primary side parallel connection](#)".

Reverse polarity protection

A simple way of creating an input reverse polarity protection is to place a diode in series with the plus input line. The diode blocks all negative voltages that might be applied at the plus input because of operating reverse biased. Due to the forward voltage drop of the diode the application efficiency drops.

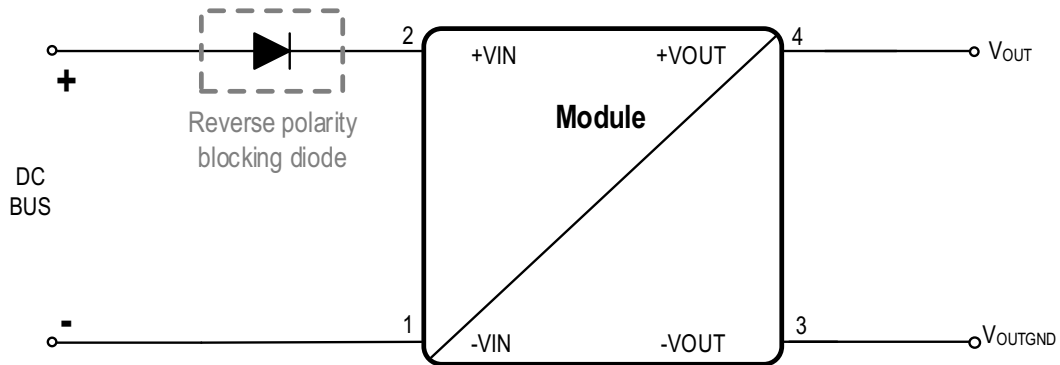

WAVE SOLDER PROFILE

Profile Feature	Old standard (Pb)	New (Pb-free)
Time within peak temperature t_p	10s	10s
Average ramp-up rate	200 °C/s	200 °C/s
Final preheat temperature T_s	130 °C/s	130 °C/s
Peak temperature T_p	+235 °C/s	+260 °C/s
Ramp-down rate	-5 °C/s	-5 °C/s
Heating rate during preheat	4 °C/s	4 °C/s

Max number of allowed cycles in wave soldering: 2 cycles

Wave Solder Diagram:

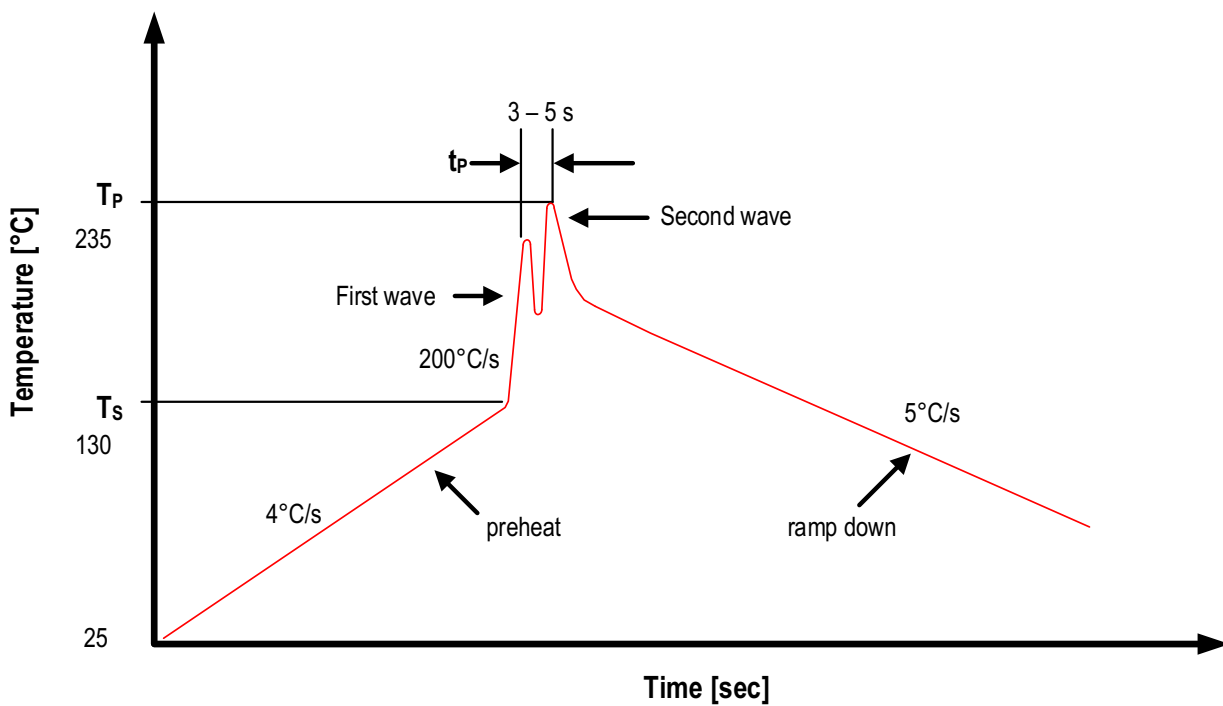

Manual Soldering

1. Maximum soldering temperature should not exceed 365 °C ± 15 °C
2. Maximum soldering time: max. 3 seconds

PHYSICAL DIMENSIONS

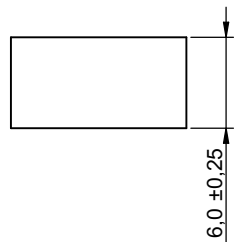
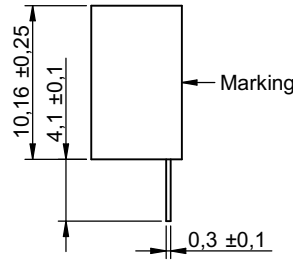
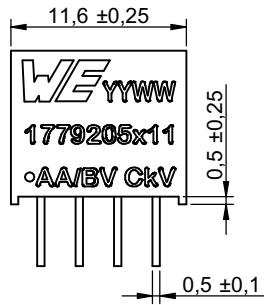
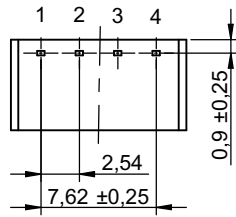

RECOMMENDED DRILL HOLES

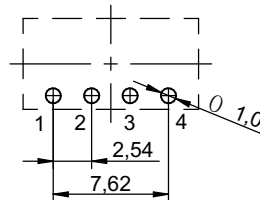

All dimensions in mm Tolerance: xx.x = ±0.5mm ; xx.xx = ±0.25mm unless otherwise noted

PACKAGING

TUBE (mm)

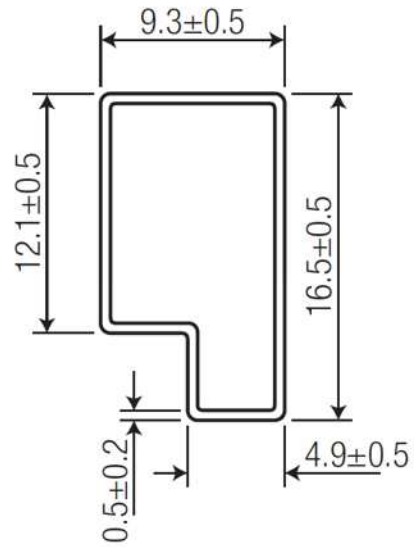

Tolerance: xx.x = ± 0.5 mm ; xx.xx = ± 0.25 mm unless otherwise noted



DOCUMENT HISTORY

Revision	Date	Description	Comment
1.0	October 2021	Initial release of data sheet	
2.0	June 2022	Extension of 3.3V version (1779205011)	

CAUTIONS AND WARNINGS

The following conditions apply to all goods within the product series of MagI³C of Würth Elektronik eiSos GmbH & Co. KG:

General:

- All recommendations according to the general technical specifications of the data-sheet have to be complied with.
- The usage and operation of the product within ambient conditions which probably alloy or harm the component surface has to be avoided.
- The responsibility for the applicability of customer specific products and use in a particular customer design is always within the authority of the customer. All technical specifications for standard products do also apply for customer specific products
- Residual washing varnish agent that is used during the production to clean the application might change the characteristics of the body, pins or termination. The washing varnish agent could have a negative effect on the long term function of the product. Direct mechanical impact to the product shall be prevented as the material of the body, pins or termination could flake or in the worst case it could break. As these devices are sensitive to electrostatic discharge customer shall follow proper IC Handling Procedures.
- Customer acknowledges and agrees that it is solely responsible for compliance with all legal, regulatory and safety-related requirements concerning its products, and any use of Würth Elektronik eiSos GmbH & Co. KG components in its applications, notwithstanding any applications-related information or support that may be provided by Würth Elektronik eiSos GmbH & Co. KG.
- Customer represents and agrees that it has all the necessary expertise to create and implement safeguards which anticipate dangerous consequences of failures, monitor failures and their consequences lessen the likelihood of failures that might cause harm and take appropriate remedial actions
- Customer will fully indemnify Würth Elektronik eiSos and its representatives against any damages arising out of the use of any Würth Elektronik eiSos GmbH & Co. KG components in safety-critical applications

Product specific:

Follow all instructions mentioned in the datasheet, especially:

- The solder profile has to comply with the technical reflow or wave soldering specification, otherwise this will void the warranty.
- All products are supposed to be used before the end of the period of 12 months based on the product date-code.
- Violation of the technical product specifications such as exceeding the absolute maximum ratings will void the warranty.
- It is also recommended to return the body to the original moisture proof bag and reseal the moisture proof bag again.
- ESD prevention methods need to be followed for manual handling and processing by machinery.

DISCLAIMER

This electronic component has been designed and developed for usage in general electronic equipment only. This product is not authorized for use in equipment where a higher safety standard and reliability standard is especially required or where a failure of the product is reasonably expected to cause severe personal injury or death, unless the parties have executed an agreement specifically governing such use. Moreover Würth Elektronik eiSos GmbH & Co. KG products are neither designed nor intended for use in areas such as military, aerospace, aviation, nuclear control, submarine, transportation (automotive control, train control, ship control), transportation signal, disaster prevention, medical, public information network etc. Würth Elektronik eiSos GmbH & Co. KG must be informed about the intent of such usage before the design-in stage. In addition, sufficient reliability evaluation checks for safety must be performed on every electronic component which is used in electrical circuits that require high safety and reliability functions or performance.

These cautions and warnings comply with the state of the scientific and technical knowledge and are believed to be accurate and reliable. However, no responsibility is assumed for inaccuracies or incompleteness.

IMPORTANT NOTES

General Customer Responsibility

Some goods within the product range of Würth Elektronik eiSos GmbH & Co. KG contain statements regarding general suitability for certain application areas. These statements about suitability are based on our knowledge and experience of typical requirements concerning the areas, serve as general guidance and cannot be estimated as binding statements about the suitability for a customer application. The responsibility for the applicability and use in a particular customer design is always solely within the authority of the customer. Due to this fact it is up to the customer to evaluate, where appropriate to investigate and decide whether the device with the specific product characteristics described in the product specification is valid and suitable for the respective customer application or not. Accordingly, the customer is cautioned to verify that the datasheet is current before placing orders.

Customer Responsibility Related to Specific, in Particular Safety-Relevant, Applications

It has to be clearly pointed out that the possibility of a malfunction of electronic components or failure before the end of the usual lifetime cannot be completely eliminated in the current state of the art, even if the products are operated within the range of the specifications. In certain customer applications requiring a very high level of safety and especially in customer applications in which the malfunction or failure of an electronic component could endanger human life or health it must be ensured by most advanced technological aid of suitable design of the customer application that no injury or damage is caused to third parties in the event of malfunction or failure of an electronic component.

Best Care and Attention

Any product-specific notes, warnings and cautions must be strictly observed. Any disregard will result in the loss of warranty.

Customer Support for Product Specifications

Some products within the product range may contain substances which are subject to restrictions in certain jurisdictions in order to serve specific technical requirements. Necessary information is available on request. In this case the field sales engineer or the internal sales person in charge should be contacted who will be happy to support in this matter.

Product R&D

Due to constant product improvement product specifications may change from time to time. As a standard reporting procedure of the Product Change Notification (PCN) according to the JEDEC-Standard we inform about minor and major changes. In case of further queries regarding the PCN, the field sales engineer or the internal sales person in charge should be contacted. The basic responsibility of the customer as per Section 1 and 2 remains unaffected.

Product Life Cycle

Due to technical progress and economical evaluation we also reserve the right to discontinue production and delivery of products. As a standard reporting procedure of the Product Termination Notification (PTN) according to the JEDEC-Standard we will inform at an early stage about inevitable product discontinuance. According to this we cannot guarantee that all products within our product range will always be available. Therefore it needs to be verified with the field sales engineer or the internal sales person in charge about the current product availability expectancy before or when the product for application design-in disposal is considered. The approach named above does not apply in the case of individual agreements deviating from the foregoing for customer-specific products.

Property Rights

All the rights for contractual products produced by Würth Elektronik eiSos GmbH & Co. KG on the basis of ideas, development contracts as well as models or templates that are subject to copyright, patent or commercial protection supplied to the customer will remain with Würth Elektronik eiSos GmbH & Co. KG. Würth Elektronik eiSos GmbH & Co. KG does not warrant or represent that any license, either expressed or implied, is granted under any patent right, copyright, mask work right, or other intellectual property right relating to any combination, application, or process in which Würth Elektronik eiSos GmbH & Co. KG components or services are used.

General Terms and Conditions

Unless otherwise agreed in individual contracts, all orders are subject to the current version of the "General Terms and Conditions of Würth Elektronik eiSos Group", last version available at www.we-online.com.