

RKT/LED

Aktor-/Sensor-Anschlussleitung, M12-Kupplung mit LED-Betriebs- und Funktionsanzeige, selbstsicherndem Schraubverschluss und angespritztem Kabel

Actuator/sensor cordset, single-ended, M12 female connector with LED operation and function indicator, self-locking threaded joint and molded cable

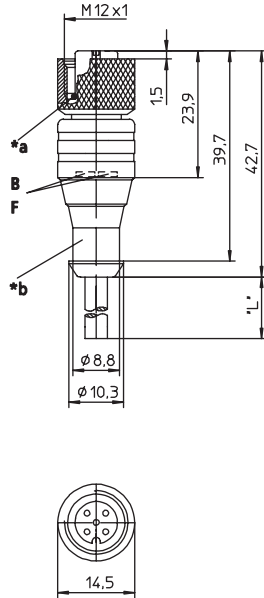

RKWT/LED

Aktor-/Sensor-Anschlussleitung, M12-Winkelkupplung mit LED-Betriebs- und Funktionsanzeige, selbstsicherndem Schraubverschluss und angespritztem Kabel

Actuator/sensor cordset, single-ended, M12 female right angle connector with LED operation and function indicator, self-locking threaded joint and molded cable

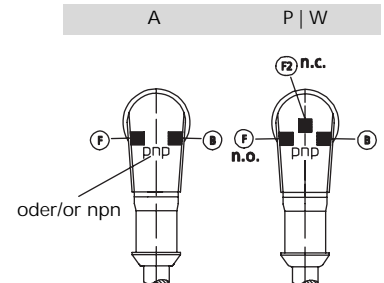
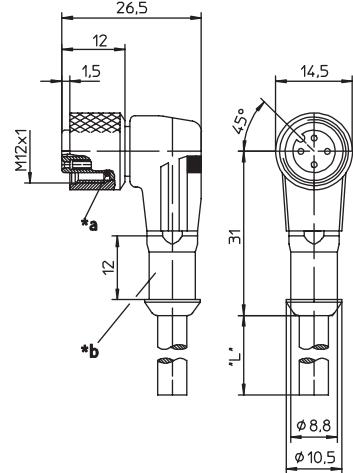

Pinbelegung Pin assignment

3-polig 3 poles

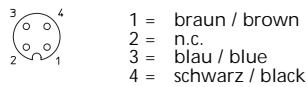

4-polig 4 poles

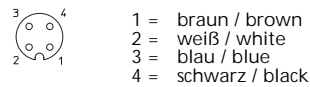

- *a O-Ring
O-ring
- *b Schutzschlauchmontage
hose mounting
- B Betriebsanzeige grün
operation indicator green
- F Funktionsanzeige gelb
function indicator yellow
- F2 Funktionsanzeige
gelb = P, weiß = W
function indicator
yellow = P, white = W

Schaltbild Wiring diagram

A pnp-Schließer /
pnp Normally open =
gelb-grün / yellow-green

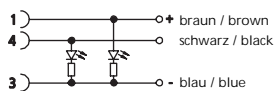

P pnp-Öffner/-Schließer /
pnp-Normally closed/open =
gelb-gelb-grün (Antivalent) /
yellow-yellow-green

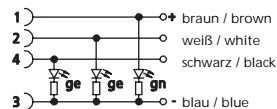

W pnp-Öffner/-Schließer /
pnp-Normally closed/open =
gelb-weiß-grün (Antivalent) /
yellow-white-green

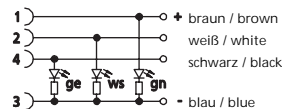

























Sonderbeschaltungen auf Anfrage / Special circuits on request

Anschlussleitungen für Aktoren, Sensoren und Verteiler Cordsets, single-ended, for actuators, sensors and distribution boxes

Technische Daten	
Umgebungstemperatur	-25°C / +80°C
Werkstoffe	
Gehäuse / Griffkörper	TPU
Kontaktträger	TPU
Kontakt	CuSn, unternickelt und 0,3 µm vergoldet
Gewindebuchse / Rändelschraube/-mutter / Sechskantschraube/-mutter / Hülse	CuZn, vernickelt
O-Ring	FKM
Mechanische Daten	
Schutzart	IP 67 Nur im verschraubten Zustand mit den dazugehörigen Gegenstücken.
Elektrische Daten	
Durchgangswiderstand	≤ 5 mΩ
Nennstrom bei 40°C	4 A
Nennspannung	10–30 V DC
Bemessungsspannung	32 V
Isolationswiderstand	> 10 ⁹ Ω
Verschmutzungsgrad	3

Technical data	
Operating temperature range	-25°C / +80°C
Materials	
Housing / Molded body	TPU
Insert	TPU
Contact	CuSn, pre-nickelated and 0.3 microns gold-plated
Receptacle shell / knurled screw/nut / hexagon screw/nut / sleeve	CuZn, nickel-plated
O-ring	FKM
Mechanical data	
Degree of protection	IP 67 Only in locked position with its proper counterparts.
Electrical data	
Contact resistance	≤ 5 mΩ
Nominal current at 40°C	4 A
Nominal voltage	10–30 V DC
Rated voltage	32 V
Insulation resistance	> 10 ⁹ Ω
Pollution degree	3

Bestellbezeichnung Designation		Polzahl Poles	Mantel Outer jacket	
RKT/LED A 4-3-06/... M	RKWT/LED A 4-3-06/... M		PVC	 
RKT/LED A 4-3-224/... M	RKWT/LED A 4-3-224/... M	3	PUR halogenfrei / halogen free	   
RKT/LED A 4-3-260/... M	RKWT/LED A 4-3-260/... M		PUR halogenfrei / halogen free schweißfunkenfest / welding spark proof	    
	RKWT/LED P 4-07/... M		PVC	
	RKWT/LED P 4-225/... M	4	PUR halogenfrei / halogen free	   
	RKWT/LED P 4-251/... M		PUR halogenfrei / halogen free schweißfunkenfest / welding spark proof	    
	RKWT/LED W 4-265/... M	4	PUR halogenfrei / halogen free	   

Standardlängen: 2 M / 5 M / 10 M
Andere Kabellängen oder Leitungsaufbauten auf Anfrage.

Standard lengths: 2 M / 5 M / 10 M
Other cable lengths or cable specifications on request.