

Kleinstsicherung, 8,5 mm, Träge T, 250 VAC, 100 A



IEC 60127-3 · 250 VAC · Träge T

**Beschreibung**

- Direkt lötlbar auf Leiterplatte
- Hohes Ausschaltvermögen

**Standards**

- IEC 60127-3/4
- UL 248-14
- CSA C22.2 no. 248.14

**Zulassungen**

- VDE Ausweisnummer: 40008838
- UL Ausweisnummer: E41599
- CSA Ausweisnummer: 51172

**Anwendungen**

- Primärschutz auf Leiterplatten
- Netzadapter für z.B. Laptops
- SMPS (Switching Mode Power Supply) für TV's und DVD's

**Referenzen****Verpackungsdetails**Zugehöriger Sicherungshalter [FMS \(250V\)](#)**Weblinks**

[pdf-Datenblatt](#), [html-Datenblatt](#), [Allgemeine Produktinformationen](#), [Zulassungen](#), [CE-Konformitätserklärung](#), [RoHS](#), [CHINA-RoHS](#), [e-Shop](#), [SCHURTER-Stock-Check](#), [Distributor-Stock-Check](#), [Detailanfrage zu Typ](#)

**Technische Daten**

Nennspannung	250 VAC
Nennstrom	0.8 - 10 A
Ausschaltvermögen	100 A
Charakteristik	Träge T
Montage	Leiterplatte, THT
Zulässige Umgebungstemp.	-40 °C bis 85 °C
Klimakategorie	40/085/21 gemäss IEC 60068-1
Material: Gehäuse	Thermoplast, UL 94V-0
Material: Anschlüsse	Kupfer, verzinkt
Einzelgewicht	0.78 g
Lagerbedingungen	0 °C bis 40 °C, max. 70% r.F.
Stempelung	Typ, Strom, Prüfspannung, Charakteristik, Prüfzeichen

Lötverfahren	Welle, Hand
Lötbarkeit	235 °C / 2 sec nach IEC 60068-2-20, Test Ta
Lötwärmebeständigkeit	260 °C / 10 sec nach IEC 60068-2-20, Test Tb
Vibrationsbeständigkeit	nach IEC 60068-2-6, Test Fc
Normalbetriebstest	1000h @ 0.60 x In @ 70 °C (nach EIA/IS-722, Test 4.4.1)
Last-/Feuchtigkeitstest	MIL-STD-202, Methode 103B 0.1*In @ 0.85 r.F. @ 85 °C
Nässe-/Widerstandstest	MIL-STD-202, Methode 106E (50 Zyklen in Wärmekammer)
Festigkeit der Anschlüsse	Zugbelastung min. 9 N (nach EIA/IS-722, Test 4.5.5)
Gehäusewiderstand	nach EIA/IS-722, Test 4.7 >100 MΩ (zw. Anschlüssen und Körper)
Mechanischer Schock	MIL-STD-202, Methode 213B (Schock 50 g, halbe Sinus-Welle, 11 ms)
Widerstandsfähigkeit gegen Lösungsmittel	MIL-STD-202, Methode 215A
Entflammbarkeit	UL 94V-0 (nach EIA/IS-722, Test 4.12)

## Abmessungen

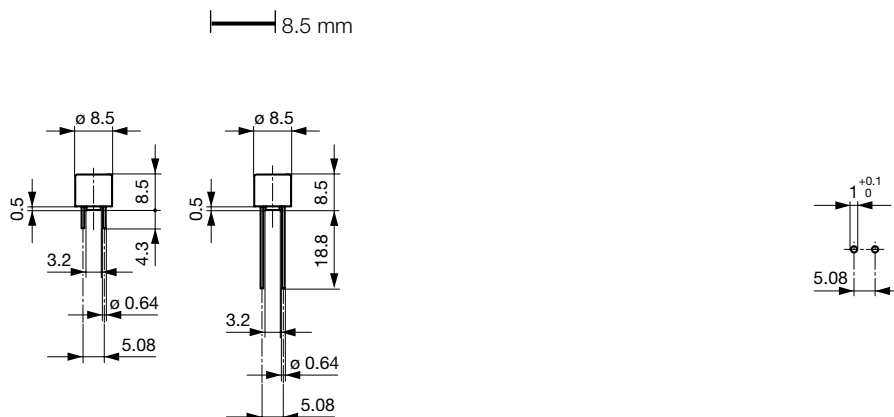

Bohrplan









## Schmelzzeiten

Nennstrom I <sub>n</sub>	1.0 x I <sub>n</sub> min.	1.5 x I <sub>n</sub> min.	2.0 x I <sub>n</sub> max.	2.1 x I <sub>n</sub> max.	2.75 x I <sub>n</sub> min.	2.75 x I <sub>n</sub> max.	4.0 x I <sub>n</sub> min.	4.0 x I <sub>n</sub> max.	10.0 x I <sub>n</sub> min.	10.0 x I <sub>n</sub> max.
0.8 A - 6.3 A	-	60 min	-	120 s	400 ms	10 s	150 ms	3 s	20 ms	150 ms
8 A - 10 A	4 h	-	60 s	-	-	-	-	-	-	-

## Varianten

S = kurze Anschlüsse  
L = lange Anschlüsse  
T = gegurtet auf Rollen

Nennstrom [A]	Nennspannung [VAC]	Ausschaltvermögen	Spannungsabfall 1.0 I <sub>n</sub> max. [mV]	Spannungsabfall 1.0 I <sub>n</sub> typ. [mV]	Verlustleistung 1.5 I <sub>n</sub> max. [mW]	Schmelzintegral 10.0 I <sub>n</sub> typ. [A <sup>2</sup> s]	DVE	VDE	UL	US C	RU	PC JET	CCC	KL	S	L	T	Bestellnummer
0.8	250	1)	160	128	430	1.5	●				●	●	●	●				0034.6914
1	250	1)	140	130	500	4.4	●				●	●	●	●				0034.6915
1.25	250	1)	130	120	600	6.3	●				●	●	●	●				0034.6916
1.6	250	1)	120	110	730	10	●				●	●	●	●				0034.6917
2	250	1)	100	85	870	16	●				●	●	●	●				0034.6918
2.5	250	1)	100	85	1000	32	●				●	●	●	●				0034.6919
3.15	250	1)	100	75	1200	57	●				●	●	●	●				0034.6920
4	250	1)	100	75	1400	77	●				●	●	●	●				0034.6921
5	250	1)	-	70	-	155					●						●	0034.6922
6.3	250	1)	-	60	-	262		●			●						●	0034.6923
8	250	1)	-	62	-	397			●								●	0034.6924
10	250	1)	-	62	-	440			●								●	0034.6925
0.8	250	1)	160	128	430	1.5	●				●	●	●	●			●	0034.6944
1	250	1)	140	130	500	4.4	●				●	●	●	●			●	0034.6945
1.25	250	1)	130	120	600	6.3	●				●	●	●	●			●	0034.6946
1.6	250	1)	120	110	730	10	●				●	●	●	●			●	0034.6947
2	250	1)	100	85	870	16	●				●	●	●	●			●	0034.6948
2.5	250	1)	100	85	1000	32	●				●	●	●	●			●	0034.6949
3.15	250	1)	100	75	1200	57	●				●	●	●	●			●	0034.6950
4	250	1)	100	75	1400	77	●				●	●	●	●			●	0034.6951
5	250	1)	-	70	-	155					●						●	0034.6952
6.3	250	1)	-	60	-	262		●			●						●	0034.6953
8	250	1)	-	62	-	397			●								●	0034.6954
10	250	1)	-	62	-	440			●								●	0034.6955
0.8	250	1)	160	128	430	1.5	●				●	●	●	●			●	0034.6974
1	250	1)	140	130	500	4.4	●				●	●	●	●			●	0034.6975
1.25	250	1)	130	120	600	6.3	●				●	●	●	●			●	0034.6976
1.6	250	1)	120	110	730	10	●				●	●	●	●			●	0034.6977
2	250	1)	100	85	870	16	●				●	●	●	●			●	0034.6978

Nennstrom [A]	Nennspannung [VAC]	Aus-schaltver-mögen	Spannungsabfall 1.0 In max. [mV]	Spannungsabfall 1.0 In typ. [mV]	Verlustleistung 1.5 I <sub>n</sub> max. [mW]	Schmelzintegral 10.0 Intyp. [A <sup>2</sup> s]									S	L	T	Bestell-Nummer
2.5	250	1)	100	85	1000	32	●		●		●	●	●	●			●	0034.6979
3.15	250	1)	100	75	1200	57	●		●		●	●	●	●			●	0034.6980
4	250	1)	100	75	1400	77	●		●		●	●	●	●			●	0034.6981
5	250	1)	-	70	-	155			●								●	0034.6982
6.3	250	1)	-	60	-	262	●		●		●						●	0034.6983
8	250	1)	-	62	-	397			●								●	0034.6984
10	250	1)	-	62	-	440			●								●	0034.6985

1) 100 A @ 250 VAC , cos φ = 1.0

**Verpackungseinheit** S = Plastiktüte (100 St.)  
 L = Kartonschachtel (100 St.)  
 T = Gegurter 36 cm Spule (750 St.)

**Zeit-Strom-Kennlinien**

