

M12 FEMALE 90°

PUR 12x0,14 black drag ch AIN 1m

M12

Female 90°

12-pole

Art.-No. 7005 - M12 Lite - (plastic hexagonal screw) on request

Plastic housings with good resistance against chemicals and oils. The resistance to aggressive media should be individually tested for your application. Further details on request. Further cable lengths on request.

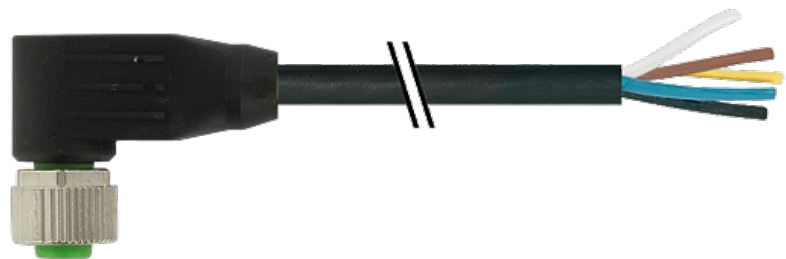
[Link to Product](#)**Illustration**

1	brown
2	blue
3	white
4	green
5	pink
6	yellow
7	black
8	gray
9	red
10	violet
11	gray/pink
12	red/blue

Female

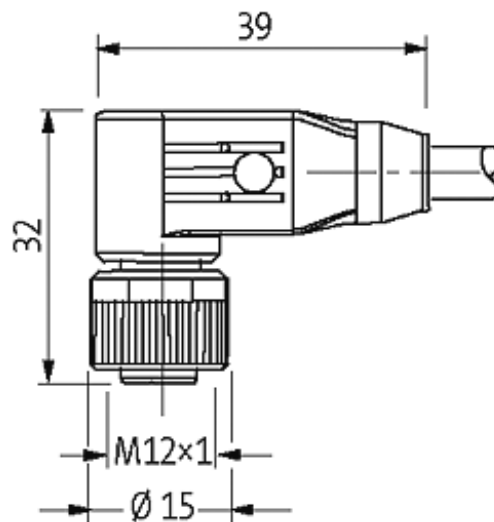
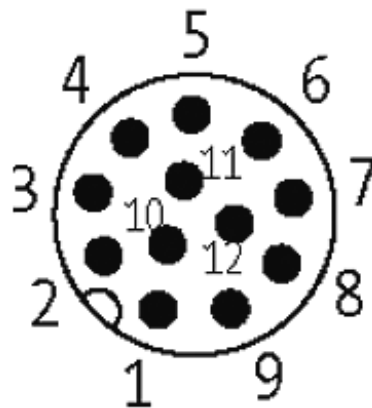

Product may differ from Image

Approvals



Form

19061

Technical Data

Operating voltage	max. 30 V AC/DC
Operating current per contact	max. 1.5 A
Locking of ports	Screw thread M12 × 1 mm (recommended torque 0.6 Nm) self-securing
Protection	IP67 inserted and tightened (EN 60529)

Cables

Cable number	705
--------------	-----

No./diameter of wires	12 × 0.14 mm ²
Wire isolation	PP (br, bl, wh, gn, pk, ye, bk, gr, rd, vi, grpk, rdbl)
C-track properties	2 Mio.
Torsion	± 180 °/m
Jacket Color	black
Shore hardness outer jacket	95 ± 5A
Material (jacket)	PUR (UL/CSA)
Outer diameter	approx. 6.0 mm
Bend radius (fixed)	5 × outer Ø
Bend radius (moving)	10 × outer Ø
Temperature range (fixed)	-40...+85 °C
Temperature range (mobile)	-25...+85 °C

Commercial data

country of origin	DE
customs tariff number	85444290
minimum order quantity	1