

Reshaping
your
world.

NORTON
SAINT-GOBAIN

ABRASIVE SOLUTIONS

INDUSTRIAL APPLICATIONS

2019



SAINT-GOBAIN

INTRODUCTION 04-12

Reshaping your world	05
Market Solutions	06
Differentiation in the range	08
Merchandising Solutions	09
Your safety is our priority	10

CUTTING & GRINDING WHEELS 13-36

Introduction	14
--------------	----

CUTTING-OFF & GRINDING WHEELS 16-29

for Metal Fabrication & Welding	16
for Rail	26
for Foundry	27
for Offshore & Oil Industry	29

CUTTING-OFF WHEELS 30-36

for Petrol Saws	30
for Chop Saws	31
for Stationary Machines	32

Technical Information	33
-----------------------	----

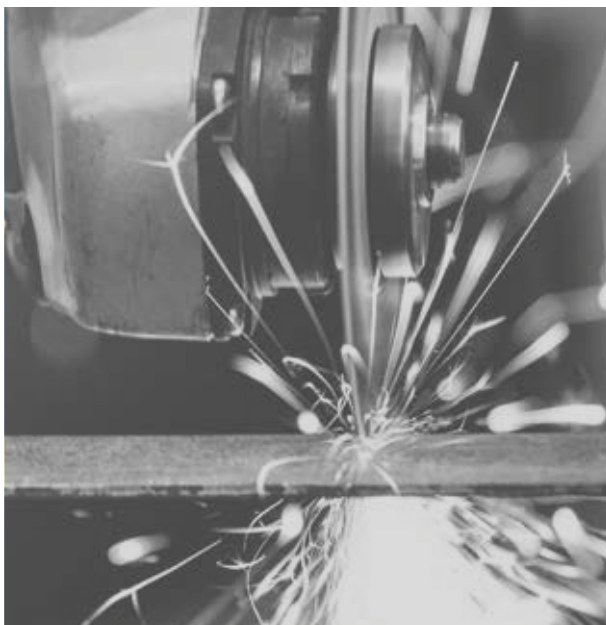

COATED ABRASIVES 37-212

Introduction	40
--------------	----

DISCS FOR ANGLE GRINDERS 45-70

Introduction	46
Fibre discs	49
Flap discs	54
Semi-flexible discs	62
Rapid Strip	63

Rapid Blend	64
Rapid Prep	66
Polishing discs	69

DISCS FOR MINI ANGLE GRINDERS 71-90

Speedlok discs	72
Mini Flap discs	77
Non-Woven Speedlok discs	80
Rapid Strip Speedlok discs	81
Rapid Blend Speedlok discs	82
Rapid Prep Speedlok discs	84
Speedlok Buffing & Polishing discs	86

DISCS FOR ORBITAL MACHINE 91-106

Norton Meshpower discs	92
Self-Grip & Beartex discs	94
Screenback discs	103
Plain discs	104
Beartex floor pads	106

WHEELS 107-142

Flap wheels	108
Convolute wheels	131
Rapid Strip wheels	136
Rapid Blend utilised wheels	138
High strength discs	140

ROLLS 143-158

Handy rolls	144
Paper & cloth rolls	148
Norton Meshpower	153
Beartex rolls	154
Rotolo Foam rolls	156

SHEETS & SPONGES 159-172

Cut sheets	160
Sheets & hand pads	163
Norton Meshpower	167
Beartex sheets & hand pads	169
Abrasive sponges	171

BELTS 173-198

File belts	174
Portable belts	180
Narrow belts	183
Rapid Prep belts	191

SPECIALTIES 199-212

Spirabands and Cones	200
Cartridge and Spiral rolls	204
Sanding stars	208

CONTENTS

BONDED ABRASIVES 213-278

Introduction 214

PRECISION GRINDING 219-248

Straight wheels 224
Straight & tapered cups 242
Dishes 245
Cylinders 246
Segments 247

MOUNTED POINTS & WHEELS 249-260

Vitrified mounted points 251
Organic mounted points 259

DRESSING STICKS & SHARPENING STONES 261-270

Dressing sticks 262
Bench & combination oil stoness 264
Abrasive & precision files 266
Abrasive slips and specialties 269

ORGANIC WHEELS & CUPS FOR SNAGGING 271-272

Snagging wheels 272
Snagging cups 272

STRAIGHT CUT-OFF WHEELS 273-266

Non-Reinforced wheels 274
Reinforced wheels 274

SUPER ABRASIVES 279-314

Introduction 280

DIAMOND & CBN GRINDING WHEELS 281-302

for Machining round tools 283
for Round tool universal grinding 287
for Sharpening saw blades 290
for Sharpening HSS saw blades 294
for General engineering 295
Diamond lapping compounds 303
Diamond files 304
Diamond Dressers 305

DIAMOND TOOLS 315-340

Introduction 316

DIAMOND BLADES 317-329

for Concrete & Reinforced Concrete 317
for Universal Building Materials 318
for Multi Materials 323
for Ceramic & Porcelain Tiles 326
for Asphalt & Abrasive Materials 329

CUP GRINDERS 330-332

for Concrete & Building Materials 330

DRILLING CORE BITS 333-338

for Concrete 333
for Universal Building Materials 336

Technical Information 338



WIRE BRUSHES & CARBIDE BURRS 341-379

Wire brushes 343
Carbide burrs 359
Bevelling tools 371
Wire wool 376



IMAGINE A WORLD SHAPED BY US - IMAGINE A WORLD WE ARE CONSTANTLY DESIGNING FOR THE BEST - IMAGINE TODAY WE ARE RESHAPING OUR WORLD TOGETHER, EVERYWHERE.

So when you rise to start your day, we have already been thinking of you and how the products we supply can deliver a material difference to shaping your world – today and tomorrow.

Saint-Gobain Abrasives brings powerful, precise and user-friendly solutions to grind, shape and finish all types of materials, across all applications everywhere around us.

To reshape our world, our customers want the smartest designs so we obsess over material sciences and technologies to design and co-develop our products with sustainability and innovation top of mind. Our customers want the right choices so we are committed to the highest standards for your safety, your comfort and your efficiency, supplying the widest portfolio of abrasives solutions.

And we cut, we shape and we finish every material for every application.

Our customers want true value partners. So focusing on our roots and our diversity, with our highly recognized Norton brand with more than 135 years of experience and with over 10,000 passionate employees, through our global network of 60 facilities in almost 30 countries across all continents, with our R&D centers in the US, Europe, China and India, our local sales professionals, application engineers, and customer services,... we dedicate ourselves to our customers and our distribution partners.

And we continually invest to optimize our supply chain and digitalize our processes, for service excellence and ultimate customer satisfaction, every day, everywhere.

We serve many market segments – Metal Fabrication, Manufacturing and Industry, Electronics and Specialties, Woodworking, Transportation, Automotive Aftermarket, Construction and Home Improvement, Energy and Environment.

At the end of the day, no matter the market, no matter the application, we're here to help your business produce results, making every day better, and reshaping your world, together.



NORTON

®

SAINT-GOBAIN

RESHAPING YOUR WORLD, TOGETHER

www.nortonabrasives.com

OUR BRAND COMMITMENTS



SERVING EVERY MARKET...





MARKET SOLUTIONS

Norton continually delivers innovative solutions across major industries – from advanced manufacturing systems to hydropower, electronics to construction, and general do-it-yourself projects to renovations. Abrasives are an integral part of reshaping your world on a daily basis: whether it's sandpaper for sanding furniture, diamond blades for cutting concrete and stone, grinding wheels for maintaining machinery and high precision grinding equipment, or vacuum discs for restoring car bodywork.

And the Norton abrasive solutions program for industrial applications addresses the needs of many markets, including:





METAL FABRICATION

At Norton, we offer abrasive solutions for rust, weld, coating and paint removal, surface blending, finishing and polishing with excellent cut rate and life. All Norton products excel in fabrication, welding, maintenance and repair operations, keeping operating cost and downtime to a minimum.



STEEL INDUSTRY

Norton abrasives for use in steel conditioning, cutting and grinding sheets, slabs, billets, bars, rounds, rolls, sheets and tubes have been designed to keep your productivity levels high and costs low. All Norton abrasives are manufactured and safety tested in accordance with the most stringent European safety standards, EN12413, ISO and oSa.



TOOLING

For precision grinding and sharpening of essential implements such as shank tools, milling tools knives and saw blades, high quality Norton diamond and cBN cups and wheels are the ultimate performance solutions to deal with the most demanding materials.



BEARING & GEARS

Norton has a full range of solutions to ensure bearings and gears are produced to the very highest standards. High performance grinding wheels with the latest innovation in bond technology; maximise efficiency and part quality. Norton profile dressers deliver a complete solution for continuous gear generation, profile grinding, bevel gear grinding, power honing.



TRANSPORTATION

From grinding and shaping to edge breaking, de-burring and finishing wings and airframes, Norton can be relied upon to deliver the highest performance. On the ground, Norton reduces operational costs and increases quality and throughput in the production of engine and body components for motorcycles, cars, trucks and trains, and for rail and track maintenance. On water, the marine industry relies on our specialist abrasives for bodywork operations.



MEDICAL

Norton abrasives produce exceptional results, helping to manufacture quality products to the most stringent requirements of the optical, medical and metallurgical industries. Highly engineered abrasive cut-off wheels, abrasive belts, non-woven de-burring / finishing wheels & belts, bonded grinding wheels and diamond & CBN tools are used throughout the production process to produce knee & hip joints, prosthetics and medical instruments.



ENERGY

The Norton Oil & Gas range is ideal for use in the manufacture and repair of upstream, midstream and downstream components, shipbuilding, oil rigs and pipelines. In addition, Norton offers complete solutions for the manufacture and maintenance of land and offshore wind turbines for OD & ID grinding, to portable cutting and finishing operations of gears and bearings, blades, vanes, seals and casings.



BUILDING & CONSTRUCTION

Norton Clipper is a one-stop shop for all cutting, drilling, grinding and sanding jobs within the building and industrial construction markets. We can equip you with the safest and highest performing construction blades, machines and abrasives that not only help to improve your personal comfort and contribute to a greener environment improve our habitat.



WOOD & FURNITURE

Whether you're a carpenter, joiner, floor liner or furniture manufacturer or restorer, Norton has a complete offering for calibration, tool sharpening and sanding and finishing applications.

...FOR MORE INFORMATION VISIT
www.nortonabrasives.com

DIFFERENTIATION IN THE RANGE

Norton offers the industry's widest selection of abrasive products to meet every customer requirement. The range is classified into three quality-tiers (good/better/best) to help you choose the right product for your specific application.

INNOVATION

Norton's innovative abrasive solutions offer outstanding productivity and versatility.

GOOD +++

Our **Good** tier products promise the highest quality you expect from the Norton name with a low initial price. These products are a great purchase to supply performance above your expectations while being a competitive choice to our budget conscious user.

BETTER ++++

Our **Better** tier products provide an excellent blend of performance and price. They may be the right fit when you can't easily measure the value of a Best tier product, but still have higher expectations for performance. You'll get your money's worth and more with the performance-to-price ratio from our Better tier.

BEST +++++

Our **Best** tier products are designed for the customer who is seeking the highest productivity at the lowest total cost. These top-of-the-range solutions mean impressive, measurable impact on your process cost. You can expect to spend less time changing abrasives and more time focusing on production when you make an investment in Best tier Norton products.

RANGE OVERVIEW

	GOOD +++	BETTER ++++	BEST +++++	INNOVATION +++++
CUTTING-OFF & GRINDING WHEELS	STARLINE	VULCAN FOUNDRY X OIL & GAS RAIL MULTI MATERIAL	OMEGA 1 2 3 ALU DIALAST	NORTON QUANTUM NORTON QUANTUM 3
COATED ABRASIVES	ALU METAL STARLINE BEARTEX RAPID STRIP BDX RAPID BLEND RAPID PREP RAPID POLISH RAPID FINISH	NORZON VULCAN VORTEX RAPID BLEND VORTEX RAPID PREP X-TREME PRO PRO FILM	NORTON QUANTUM GREENLYTE NORSTAR BLAZE RAPID STRIP BLAZE RED HEAT PRO PLUS BLUEFIRE NORZON VIKING SG MESHPOWER RED-X	NORTON QUANTUM
BONDED ABRASIVES	38A 19A 32A A 39A 37A	SGA/SGB 38A VS3 GF	NQ SG VS3 3SG/SSG	NQ VS3
DIAMOND TOOLS	CLASSIC	PRO	EXTREME	-
SUPER ABRASIVES	B49	B99	AZTEC IV ECO LINE	-

MERCHANDISING SOLUTIONS

We have a complete set of Norton branded displays to help showcase our products in all environments, plus off the shelf point-of-sale graphics that can also be tailored to customer requirements whether that's for cutting, grinding, stock removal, or surface preparation and finishing.



DISPLAY KITS

- The complete kit comes with all components needed to create a full display for any product range.
- Kit contains: Base x1, pegboards x4, header x1, shelf x1, display bar with 5 pins x1, legs x2, pegs x35
- Accessories can be ordered separately if required.

DISPLAY KIT TYPES	PK QTY	NORTON	CLIPPER
Kit with light	1	410076979	410048416
Kit with light (UK plug)	1	410058121	410050915
Kit without light	1	410076980	410048415

ACCESSORIED	PK QTY	NORTON	CLIPPER
Header with light	1		
Header without light	1		
Shelf	1	MTO	MTO
Drill motor hooks x2	1		
Euro hooks x35	1		
Core Drill hook	1		

PORTABLE DISPLAY FOR CUTTING-OFF & GRINDING WHEELS

- Kit contains: Unit x1, header x1, pins x22, side panels x2
- H: 1740mm x W: 380mm x D: 580mm

DESCRIPTION	PK QTY	ART NO.
Portable stand	1	410090016



POINT-OF-SALE GRAPHICS

Graphic templates can be adapted to suit your requirements. For information about tailored designs please contact your local sales representative

EXAMPLE TEMPLATES

SURFACE PREPARATION & FINISHING



MATERIAL REMOVAL



CUTTING & GRINDING



YOUR SAFETY IS OUR PRIORITY

Abrasive safety starts with us. Your safety is our first priority so all Norton products are manufactured in accordance with the most rigorous European and International health, safety and environmental norms. We understand your environment is tough and demanding, risks and expectations are high, you risk life and limb every time you pick up a machine to cut, grind or sand. That's why we'll always make sure our products perform to the highest standard, safely. Not only that, we give great importance to maintaining safe working conditions for our own employees throughout the production process.

oSa®

The Organisation for the Safety of Abrasives

As a member of oSa, we position ourselves amongst quality manufacturers with the highest safety levels and we're proud to carry the trademark. Through a stringent monitoring and audit system year after year, we maintain our reputation as a reliably safe and responsible producer of quality abrasives. We conform to European and International standards, EN12413, EN13236 and EN13743 for bonded, diamond and coated products and ISO 9001, 14001 and OHSAS 18001 for our manufacturing sites. This is not just because it's a legal requirement, it's also because we care. Opt for the oSa® trademark; tested quality products of the highest safety level.

FEPA

The Federation of European Producers of Abrasives

As a member of the FEPA association, we're always up to date with the latest technical, legal and scientific regulatory frameworks, meaning we're always one step ahead. Together with oSa, FEPA pursues the objective of supporting both the currently attained safety standards and further future developments.

Our Commitment to Employees and Sustainability

As a global leader, and aligned with our business values and vision, our operational policies and practices underpin our commitment to employees and sustainability, which include: pursuing an ambitious policy to constantly improve workplace health & safety; continuously encouraging the personal development of our employees; being a responsible and sustainable player internationally and within our local communities; minimizing the environmental footprint of our operations with five clear priorities; continuously developing eco-valORIZED products bringing additional value to our customers.



The mark of responsible forestry

For more information on our commitment to employees and sustainability, and for detailed safety advice please visit our website www.norton-abrasives.com. You can also find helpful tips and Do's & Don'ts on Safety in each of the product sections throughout the catalogue.





HORTON
SAINT-SAIN

Reshaping
your
world.



DISCOVER MORE FROM
OUR EXPERTS AT:

www.nortonabrasives.com

NORTON

SAINT-GOBAIN®



NORTON

SAINT-GOBAIN®

CUTTING-OFF &
GRINDING WHEELS

CUTTING-OFF & GRINDING WHEELS

Introduction 14

CUTTING-OFF & GRINDING WHEELS 16-29

for Metal Fabrication & Welding 16

for Rail 26

for Foundry 27

for Offshore & Oil Industry 29

CUTTING-OFF WHEELS

for Petrol Saws 30

for Chop Saws 31

for Stationary Machines 32

Technical Information 33

CUTTING-OFF & GRINDING WHEELS

INTRODUCTION

The Norton range of Cutting-off and Grinding Wheels for portable and fixed machines provide superior performance in the most stringent working environment. The product range includes state-of-the-art solutions for Cutting-off, Grinding, and Surface Finishing operations on any materials related to industrial fabrication markets. Norton, the industry's most comprehensive Cutting-off and Grinding product line.



UNDERSTANDING THE PRODUCT

- 1 Best quality tier
- 2 Application material
- 3 Diameter x Thickness x Hole
- 4 Product specification
- 5 Maximum peripheral speed
- 6 Machine cutting or grinding
- 7 Product code
- 8 OSA certification
- 9 EN12413

PRODUCT SELECTION GUIDE

GRINDING WHEELS FOR ANGLE GRINDERS



Highly recommended ●

MATERIALS	NORTON QUANTUM3	OMEGA	VULCAN	STARLINE	1-2-3	ALU	FOUNDRY X	DIALAST	OIL & GAS
	+++++	+++++	++++	+++	+++++	++++	++++	+++++	++++
Steel / construction steel	●	●	●	●	●		●		●
Low alloy	●	●	●	●	●		●		●
High alloy	●	●		●					●
Thin sheets, plates, profiles	●	●	●						●
Stainless steel / inox	●	●	●		●				●
Cast iron							●		
Non ferrous						●			
Titanium	●		●			●			
Stone concrete			●						
Tiles ceramics			●						

PRODUCT SELECTION GUIDE

CUTTING-OFF WHEELS FOR ANGLE AND STRAIGHT GRINDERS

Highly recommended ●



MATERIALS	NEW NORTON QUANTUM3	OMEGA	VULCAN	STARLINE	1-2-3	ALU	FOUNDRY X	DIALAST	OIL & GAS	RAIL	MULTI MATERIAL
	+++++	+++++	++++	+++	+++++	++++	++++	++++	++++	++++	++++
Steel / construction steel	●	●	●	●	●		●	●	●	●	●
Low alloy	●	●	●	●			●		●	●	●
High alloy	●	●							●		
Thin sheets, plates, profiles	●	●	●	●					●		●
Stainless steel / inox	●	●	●						●		●
Cast iron							●	●			
Non ferrous						●					●
Titanium	●					●					●
Stone concrete											●
Tiles ceramics											●
Rail hard grade										●	
Rail medium grade										●	
Rail soft grade										●	
Glass ceramics PVC											●

NORTON
SAINT-GOBAIN®

QUANTUM 3

- 1 OPERATOR COMFORT...**
Reduced hand fatigue from less cutting vibration.
- 2 LESS GRINDING TIME...**
A sharper wheel for the highest metal removal & faster cutting action.
- 3 LESS DOWNTIME & WASTE...**
From longer wheel life, using fewer wheels.

UTG
ULTRA THIN GRINDING





CUTTING-OFF & GRINDING WHEELS FOR METAL FABRICATION & WELDING

The use of abrasives in secondary steel industries is vast; from ship building and production of domestic appliances, automotive and construction components, special profiles, pipes and electrical goods to maintenance and repair of equipment, tools and machines.

NORTON QUANTUM **+++++** INNOVATION ULTIMATE TECHNOLOGY

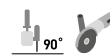
- Premium aggressive NorZon Heavy Duty grain
- Revolutionary Patent Pending Bond Technology
- No other wheel lasts longer
- Lowest total abrasive costs
- High metal removal rate



	TYPE	DIA (mm)	TxB (mm)	SPEC	PK QTY	ART NO.	PRICE	
CUTTING-OFF WHEELS								
	TYPE 41	115	1,0x22,23	ZA 60 ZZ	25	66252836338	£000.00	
				1,3x22,23	ZA 60 ZZ	25	66252836897	£000.00
				1,6x22,23	ZA 46 ZZ	25	66252836339	£000.00
		125	1,0x22,23	ZA 60 ZZ	25	66252836340	£000.00	
			1,3x22,23	ZA 60 ZZ	25	66252836898	£000.00	
			1,6x22,23	ZA 46 ZZ	25	66252836341	£000.00	
	TYPE 42	180	1,6x22,23	ZA 46 ZZ	25	66252837989	£000.00	
			230	1,9x22,23	ZA 46 ZZ	25	66252837990	£000.00
			115	0,8x22,23	ZA 60 ZZ	25	66252840228	£000.00
		125	0,8x22,23	ZA 60 ZZ	25	66252838243	£000.00	



NEW NORTON QUANTUM3 ULTRA THIN CUTTING-OFF WHEELS

+++++ INNOVATION



- Cutting performance taken to a new level in comfort, life and speed.
- For precision, speed and the most accurate cut with reduced vibration levels, helping you to cut more comfortably for longer.

- Ceramic grains give this wheel it's unique character. 1,3mm for ultimate speed and comfort. 1,6mm for absolute stability and longest life.
- Delivers best in class performance on Steel and Stainless Steel.



	TYPE	DIA (mm)	TxB (mm)	SPEC	PK QTY	ART NO.	PRICE
	TYPE 41	115	1,3x22,23	NQ 60 ZZ	25	66253371348	£000.00
			1,6x22,23	NQ 46 ZZ	25	66253371349	£000.00
	125	1,3x22,23	NQ 60 ZZ	25	66253371351	£000.00	
		1,6x22,23	NQ 46 ZZ	25	66253371352	£000.00	

NEW NORTON QUANTUM3 CUTTING-OFF WHEELS

+++++ INNOVATION



- Greater wheel thickness for a more robust cut.
- Ceramic grain provides a fast, sharp cut time and time again.
- Incomparable speed in rough cutting applications on black steel.

- Ideal for large steel projects, shipyards, steel construction and general engineering.



	TYPE	DIA (mm)	TxB (mm)	SPEC	PK QTY	ART NO.	PRICE
	TYPE 42	125	2.5x22.23	NQ 24 P	25	66252832258	£000.00
			180	2.5x22.23	NQ 24 P	25	66252845041

HOW WILL IT BENEFIT YOU?

OPERATOR COMFORT

with reduced hand fatigue from less cutting vibration

LESS CUTTING TIME

with a sharper disc in two thicknesses for speed and life

LESS DOWNTIME & WASTE

with longer disc life using fewer discs







EXPERIENCE EXTRASMOOTH CUTTING ACTION, THANKS TO OUR PREMIUM CERAMIC GRAIN.

CUTTING-OFF & GRINDING WHEELS FOR METAL FABRICATION & WELDING

NORTON QUANTUM3 **+++++** INNOVATION
GRINDING WHEELS

- Self sharpening ceramic grain technology for high material removal and less grinding time
- More comfortable to use with reduced hand fatigue from less cutting vibration
- Longer wheel life means less downtime and waste, fewer wheels needed
- Offers true savings in grinding processes

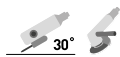

	TYPE	DIA (mm)	TxB (mm)	SPEC	PK QTY	ART NO.	PRICE
GRINDING WHEELS							
 	 TYPE 27	115	7,0x22,23	NQ 24 P	10	66253371361	£000.00
		125	7,0x22,23	NQ 24 P	10	66253371362	£000.00
		150	7,0x22,23	NQ 24 P	10	66253371363	£000.00
		180	7,0x22,23	NQ 24 P	10	66253371364	£000.00
		230	7,0x22,23	NQ 24 P	10	66253371365	£000.00
  							
		125	7,0x22,23	NQ 24 N	10	66252839321	£000.00
		230	7,0x22,23	NQ 24 N	10	66252839322	£000.00



NORTON QUANTUM3
ULTRA THIN GRINDING WHEELS

- Fast grinding formula, gets the job done faster
- Improved grinding control ensures precise grinding accuracy
- Get to work in hard to reach areas like corners and grooves
- Smoother feel, reduced fatigue and improve operator comfort
- Boost the amperage on cordless grinders due to light weight / fast cutting



	TYPE	DIA (mm)	TxB (mm)	SPEC	PK QTY	ART NO.	PRICE
COMBINATION WHEELS							
 TYPE 27		115	4,2x22,23	NQ 24 R	20	66253371356	£000.00
		125	4,2x22,23	NQ 24 R	20	66253371357	£000.00
		150	4,2x22,23	NQ 24 R	20	66253371358	£000.00
		180	4,2x22,23	NQ 24 R	20	66253371359	£000.00
		230	4,2x22,23	NQ 24 R	20	66253371360	£000.00

NORTON
 SAINT-GOBAIN
QUANTUM3
+++++ INNOVATION
COMBO
CERAMIC ADVANTAGE
 Metal, Steel, Stahl, Metallo, Inox, Stainless
 125 x 4,2 x 22,23
 NQ24R - BF27
 MAX: 12,250 rpm / 80 m/s
 Made in EU
 66253371357
 EN 12413
 4791629938

UTG
ULTRA THIN GRINDING

OMEGA **+++++**

- High performance aluminium oxide grain for fast and high material removal
- Superior bond system holds the grain for long wheel life, resulting in less wheel usage
- Ideal for heavy industrial use on all hard steel types and alloys



CUTTING-OFF WHEELS							
	TYPE	DIA (mm)	TxB (mm)	SPEC	PK QTY	ART NO.	PRICE
	TYPE 41 	115	1,0x22,23	A 60 W	25	66253370025	£000.00
			1,6x22,23	A 46 W	25	66253370026	£000.00
		125	1,0x22,23	A 60 W	25	66253370029	£000.00
			1,6x22,23	A 46 W	25	66253370030	£000.00
		150	1,6x22,23	A 46 W	25	66253370033	£000.00
	TYPE 41 	115	2,0x22,23	A 36 W	25	66253370027	£000.00
				A 36 W	25	66253370028	£000.00
		125	2,0x22,23	A 36 W	25	66253370031	£000.00
				A 36 W	25	66253370032	£000.00
		180	2,0x22,23	A 36 W	25	66253370035	£000.00
230		2,0x22,23	A 36 W	25	66253370037	£000.00	
			A 36 W	25	66253370039	£000.00	
TYPE 42 		115	2,5x22,23	A 36 W	25	66253370040	£000.00
				A 36 W	25	66253370041	£000.00
				A 36 W	25	66253370043	£000.00
	A 36 W			25	66253370044	£000.00	



COMBINATION WHEELS							
	TYPE	DIA (mm)	TxB (mm)	SPEC	PK QTY	ART NO.	PRICE
	TYPE 27 	125	4,0x22,23	A 24 S	10	66253370042	£000.00



GRINDING WHEELS							
	TYPE	DIA (mm)	TxB (mm)	SPEC	PK QTY	ART NO.	PRICE
	TYPE 27 	115	7,0x22,23	A 24 S	10	66253370045	£000.00
		125	7,0x22,23	A 24 S	10	66253370046	£000.00
		150	7,0x22,23	A 24 S	10	66253370047	£000.00
		180	7,0x22,23	A 24 S	10	66253370048	£000.00
		230	7,0x22,23	A 24 S	10	66253370050	£000.00

CUTTING-OFF & GRINDING WHEELS FOR METAL FABRICATION & WELDING

VULCAN

- Great price versus performance ratio
- Longer wheel life
- The general purpose range of cutting-off and grinding wheels



METAL
INOX



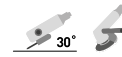

	TYPE	DIA (mm)	TxB (mm)	SPEC	PK QTY	ART NO.	PRICE
CUTTING-OFF WHEELS							
		115	1,0x22,23	A 60 S	25	66252925431	£000.00
			1,6x22,23	A 46 S	25	66252925432	£000.00
			2,0x22,23	A 30 S	25	66252925437	£000.00
			2,5x22,23	A 30 S	25	66252925442	£000.00
			3,0x22,23	A 30 S	25	66252925447	£000.00
		125	1,0x22,23	A 60 S	25	66252925433	£000.00
			1,6x22,23	A 46 S	25	66252925434	£000.00
			2,0x22,23	A 30 S	25	66252925438	£000.00
			2,5x22,23	A 30 S	25	66252925443	£000.00
			3,0x22,23	A 30 S	25	66252925448	£000.00
		150	2,0x22,23	A 30 S	25	66252925439	£000.00
			2,5x22,23	A 30 S	25	66252925444	£000.00
		180	1,6x22,23	A 46 S	25	66252925435	£000.00
			2,0x22,23	A 30 S	25	66252925440	£000.00
			2,5x22,23	A 30 S	25	66252925445	£000.00
			3,0x22,23	A 30 S	25	66252925449	£000.00
		230	1,9x22,23	A 46 S	25	66252925436	£000.00
			2,0x22,23	A 30 S	25	66252925441	£000.00
		2,5x22,23	A 30 S	25	66252925446	£000.00	
		3,0x22,23	A 30 R	25	66252840202*	£000.00	
		3,0x22,23	A 30 S	25	66252925450	£000.00	
	100	3,2x22,23	A 30 S	25	66252835417*	£000.00	
	115	2,5x22,23	A 30 S	25	66252925490	£000.00	
		3,2x22,23	A 30 S	25	66252925494	£000.00	
	125	2,5x22,23	A 30 S	25	66252925491	£000.00	
		3,2x22,23	A 30 S	25	66252925495	£000.00	
	150	3,2x22,23	A 30 S	25	66252925496	£000.00	
	180	2,5x22,23	A 30 S	25	66252925492	£000.00	
		3,2x22,23	A 30 S	25	66252925497	£000.00	
	230	2,5x22,23	A 30 S	25	66252925493	£000.00	
		3,2x22,23	A 30 S	25	66252925498	£000.00	

* Made-to-order



METAL INOX



	TYPE	DIA (mm)	TxB (mm)	SPEC	PK QTY	ART NO.	PRICE
GRINDING WHEELS							
  TYPE 27		100	6,4x16,0	A 30 S	10	66252926667*	€000.00
		115	4,0x22,23	A 30 S	10	66252925518*	€000.00
			6,4x22,23	A 30 S	10	66252925522	€000.00
		125	4,0x22,23	A 30 S	10	66252925519	€000.00
			6,4x22,23	A 30 S	10	66252925523	€000.00
			8,0x22,23	A 30 S	10	66252925524	€000.00
		150	6,4x22,23	A 30 S	10	66252925525	€000.00
		180	10,0x22,23	A 30 S	10	66252925528	€000.00
			4,0x22,23	A 30 S	10	66252925520	€000.00
			6,4x22,23	A 30 S	10	66252925526	€000.00
			8,0x22,23	A 30 S	10	66252925527	€000.00
		230	4,0x22,23	A 30 S	10	66252925521	€000.00
			6,4x22,23	A 30 S	10	66252925529	€000.00
			8,0x22,23	A 30 S	10	66252925530	€000.00

* Made-to-order



VULCAN FAST CUT

- For use on low power machines
- Medium and hard steel types



METAL INOX



	TYPE	DIA (mm)	TxB (mm)	SPEC	PK QTY	ART NO.	PRICE
GRINDING WHEELS							
  TYPE 27		115	6,4x22,23	A 30 P	10	66252830803	€000.00
		125	6,4x22,23	A 30 P	10	66252830804	€000.00
		180	6,4x22,23	A 30 P	10	66252830805	€000.00
			8,0x22,23	A 30 P	10	66252830806*	€000.00
		230	6,4x22,23	A 30 P	10	66252830807	€000.00

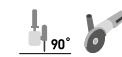

* Made-to-order

VULCAN



INOX



	TYPE	DIA (mm)	TxB (mm)	SPEC	PK QTY	ART NO.	PRICE
CUTTING-OFF WHEELS							
  TYPE 41		115	1,0x22,23	A 60 T Inox	25	66252833400	€000.00
			1,6x22,23	A 46 T Inox	25	66252833401	€000.00
		125	1,0x22,23	A 60 T Inox	25	66252833402	€000.00
			1,6x22,23	A 46 T Inox	25	66252833403	€000.00
			2,5x22,23	A 30 S Inox	25	66252833409	€000.00
		150	1,6x22,23	A 46 T Inox	25	66252833404	€000.00
		180	1,6x22,23	A 46 T Inox	25	66252833405	€000.00
		230	1,9x22,23	A 46 T Inox	25	66252833406	€000.00
			2,5x22,23	A 30 S Inox	25	66252925427	€000.00
	 TYPE 42		115	2,5x22,23	A 30 S Inox	25	66252925486*
		125	2,5x22,23	A 30 S Inox	25	66252925487	€000.00
		230	2,5x22,23	A 30 S Inox	25	66252925489	€000.00

CUTTING-OFF & GRINDING WHEELS FOR METAL FABRICATION & WELDING



	TYPE	DIA (mm)	TxB (mm)	SPEC	PK QTY	ART NO.	PRICE
GRINDING WHEELS							
	TYPE 27 	115	6,4x22,23	A 30 S Inox	10	66252925513	£000.00
		125	6,4x22,23	A 30 S Inox	10	66252925514	£000.00
		180	6,4x22,23	A 30 S Inox	10	66252925516	£000.00
		230	6,4x22,23	A 30 S Inox	10	66252925517	£000.00



	TYPE	DIA (mm)	TxB (mm)	SPEC	PK QTY	ART NO.	PRICE
CUTTING-OFF WHEELS							
	TYPE 41 	115	3,0x22,23	C 30 R	25	66252925452	£000.00
		125	3,0x22,23	C 30 R	25	66252925453	£000.00
		230	3,0x22,23	C 30 R	25	66252925456	£000.00
	TYPE 42 	115	3,2x22,23	C 30 R	25	66252925500	£000.00
125		3,2x22,23	C 30 R	25	66252925501	£000.00	
180		3,2x22,23	C 30 R	25	66252925502*	£000.00	
		230	3,2x22,23	C 30 R	25	66252925503	£000.00

* Made-to-order



	TYPE	DIA (mm)	TxB (mm)	SPEC	PK QTY	ART NO.	PRICE
GRINDING WHEELS							
	TYPE 27 	115	6,4x22,23	C 30 R	10	66252925533	£000.00
		125	6,4x22,23	C 30 R	10	66252925534	£000.00
		180	6,4x22,23	C 30 R	10	66252925535	£000.00
		230	6,4x22,23	C 30 R	10	66252925537	£000.00



STARLINE

- General trade product
- Complete range of most used products

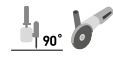

	TYPE	DIA (mm)	TxB (mm)	SPEC	PK QTY	ART NO.	PRICE
CUTTING-OFF WHEELS							
	TYPE 41	115	1,0x22,23	A 60 R	25	66252837243	£000.00
		115	1,0x22,23	A 60 R - SET**	10	66252837575*	£000.00
	TYPE 41	125	1,0x22,23	A 60 R	25	66252837245	£000.00
		125	1,0x22,23	A 60 R - SET**	10	66252837576	£000.00
	TYPE 41	180	1,6x22,23	A 46 R	25	66252837246	£000.00
		180	1,6x22,23	A 46 R - SET**	10	66252837577*	£000.00
	TYPE 41	230	2,0x22,23	A 36 R	25	66252837248	£000.00

** Minimum order quantity - 20 sets
* Made-to-order



	TYPE	DIA (mm)	TxB (mm)	SPEC	PK QTY	ART NO.	PRICE
CUTTING-OFF WHEELS							
	TYPE 41	115	2,5x22,23	A 30 P	25	66252837249*	£000.00
		125	2,5x22,23	A 30 P	25	66252837250	£000.00
		180	2,5x22,23	A 30 P	25	66252837251	£000.00
		230	2,5x22,23	A 30 P	25	66252837253	£000.00
	TYPE 42	115	3,0x22,23	A 30 P	25	66252837275*	£000.00
		125	3,0x22,23	A 30 P	25	66252837276	£000.00
		180	3,0x22,23	A 30 P	25	66252837277	£000.00
		230	3,0x22,23	A 30 P	25	66252837278	£000.00

* Made-to-order



	TYPE	DIA (mm)	TxB (mm)	SPEC	PK QTY	ART NO.	PRICE
GRINDING WHEELS							
	TYPE 27	115	6,0x22,23	A 24 Q	10	66252837263	£000.00
		125	6,0x22,23	A 24 Q	10	66252837264	£000.00
		180	6,0x22,23	A 24 Q	10	66252837268	£000.00
		230	6,0x22,23	A 24 Q	10	66252837269	£000.00

NORTON
SAINT-GOBAIN

123
ALL IN ONE

+++++

A46S - BF27
MAX: 12,250 rpm
80 m/s

ACIER, STAHL, ACCIAIO, S, INOX

SAINT-GOBAIN Abrasives,
Rue de l'Ambassadeur,
78702 Conflans,
France

46803

90° 30° 15°

METAL INOX

1-2-3
THE ALL IN ONE SOLUTION

- Cut, grind and finish with one wheel
- No lost time due to wheel changing
- Fine grit for a good, uniform finish
- Three layers of reinforcement for maximum safety in use

TYPE	DIA (mm)	TxB (mm)	SPEC	PK QTY	ART NO.	PRICE
COMBINATION WHEELS						
TYPE 27	115	2,2x22,23	A 46 S	25	66252829704	€000.00
	125	2,2x22,23	A 46 S	25	66252921592	€000.00

NORTON
SAINT-GOBAIN

MULTI MATERIAL

+++++

C46T - BF41
MAX: 12,250 rpm
80 m/s

ALU METAL INOX
STONE C.TILES PVC

SAINT-GOBAIN Abrasives
European Headquarters
Rue de l'Ambassadeur -
B.P. 8, 78702 Conflans
Cedex France

66298

90°

MULTI MATERIAL

- One wheel for all materials
- No lost time due to wheel changing
- The easy choice in general trade
- Quick, comfortable and versatile

TYPE	DIA (mm)	TxB (mm)	SPEC	PK QTY	ART NO.	PRICE
CUTTING-OFF WHEELS						
	115	1,0x22,23	C 60 T	25	66252833258	€000.00
		1,6x22,23	C 46 T	25	66252828951	€000.00
TYPE 41	125	1,0x22,23	C 60 T	25	66252918924	€000.00
		1,6x22,23	C 46 T	25	66252828952	€000.00
	180	1,6x22,23	C 46 T	25	66252926730	€000.00
	230	1,9x22,23	C 46 T	25	66252918925	€000.00

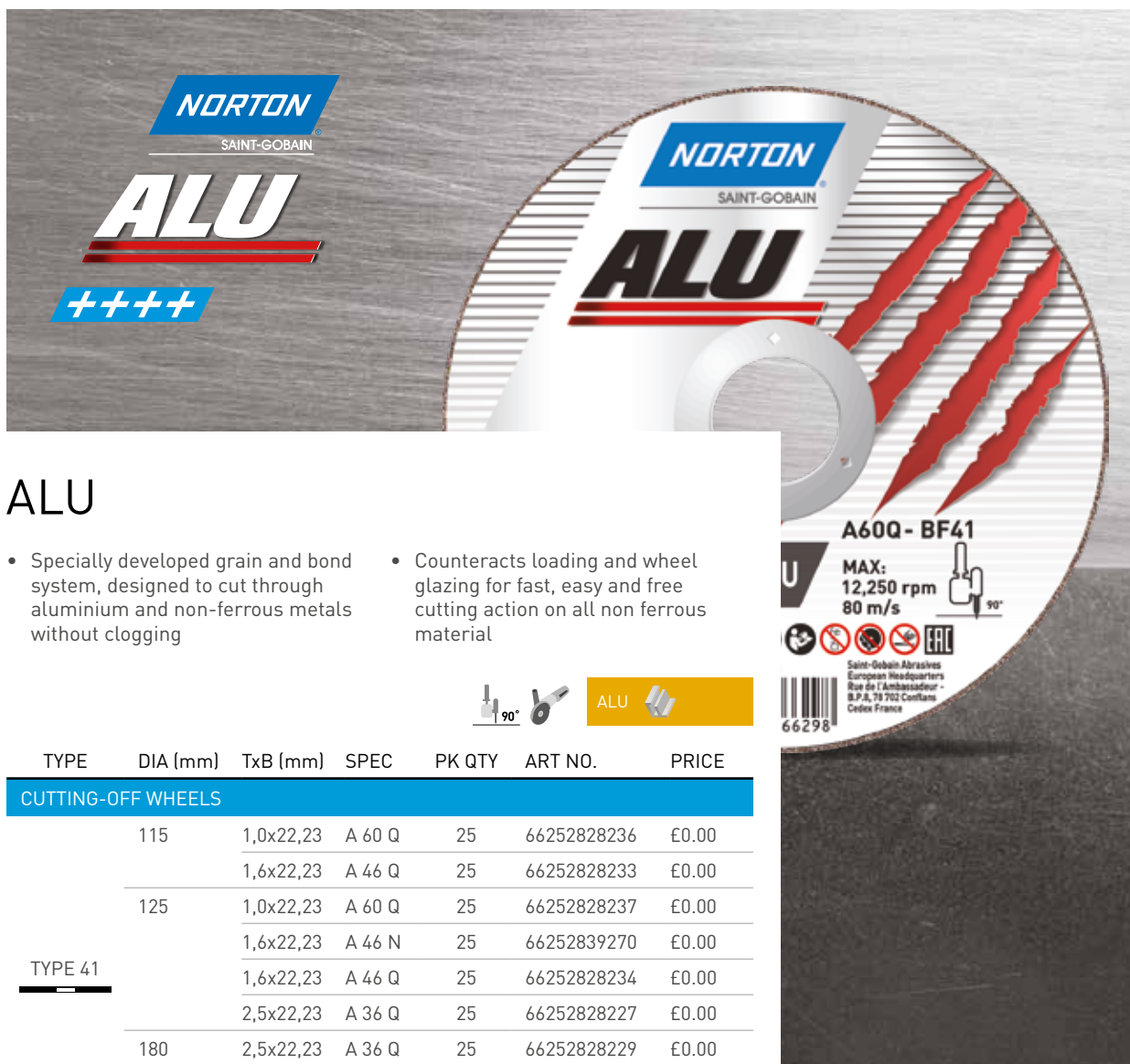

NORTON
SAINT-GOBAIN
ALU
++++

NORTON
SAINT-GOBAIN
ALU

A60Q - BF41

U

MAX:
12,250 rpm
80 m/s

90°

66298

Saint-Gobain Abrasives
European Headquarters
Rue de l'Ambassadeur -
B.P.8, 78 702 Conflans
Cedex France

• Specially developed grain and bond system, designed to cut through aluminium and non-ferrous metals without clogging



• Counteracts loading and wheel glazing for fast, easy and free cutting action on all non ferrous material

ALU

- Specially developed grain and bond system, designed to cut through aluminium and non-ferrous metals without clogging
- Counteracts loading and wheel glazing for fast, easy and free cutting action on all non ferrous material



ALU

TYPE	DIA (mm)	TxB (mm)	SPEC	PK QTY	ART NO.	PRICE
CUTTING-OFF WHEELS						
TYPE 41 	115	1,0x22,23	A 60 Q	25	66252828236	€0.00
		1,6x22,23	A 46 Q	25	66252828233	€0.00
	125	1,0x22,23	A 60 Q	25	66252828237	€0.00
		1,6x22,23	A 46 N	25	66252839270	€0.00
		1,6x22,23	A 46 Q	25	66252828234	€0.00
		2,5x22,23	A 36 Q	25	66252828227	€0.00
180	2,5x22,23	A 36 Q	25	66252828229	€0.00	
230	1,9x22,23	A 46 N	25	66252839271	€0.00	
	1,9x22,23	A 46 Q	25	66252828235	€0.00	
TYPE 42 	230	3,0x22,23	A 36 Q	25	66252828231	€0.00

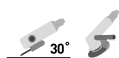

ALU

TYPE	DIA (mm)	TxB (mm)	SPEC	PK QTY	ART NO.	PRICE
GRINDING WHEELS						
TYPE 27 	125	7,0x22,23	A 36 Q	10	66252828228	€0.00
	180	7,0x22,23	A 36 Q	10	66252828230	€0.00
	230	7,0x22,23	A 36 Q	10	66252828232	€0.00



CUTTING-OFF & GRINDING WHEELS FOR RAIL

The Norton Rail range provides high performance wheels for demanding operations. Rail cutting requires precision, speed and power and Norton Rail is a complete program of cutting wheels suitable for any rail type (subway, tram, train) and any rail cutting machine with a clamping device (electrical and petrol).

NEW NORTON QUANTUM3 RAIL **+++++** INNOVATION

- The safest product to use in rail currently
- Norton Quantum3 Rail is your first ever Ceramic Grain Rail cutting wheel, giving it speeds beyond comparison
- No burning, clean quick cutting
- Life and Speed combined, do the job is less time and with less effort



	TYPE	DIA (mm)	TxB (mm)	SPEC	PK QTY	ART NO.	PRICE
CUTTING-OFF WHEELS							
	TYPE 41	356	4.0x25,4	NQ24Q	10	66252845406	£000.00

RAIL **+++++** INNOVATION

- For a precise, straight and fast cut on rail, tram and subway track
- Low vibration, consistent performance throughout wheel life
- Hard, medium and soft wheels available
- High quality cut to help generate a perfect weld



	TYPE	DIA (mm)	TxB (mm)	SPEC	PK QTY	ART NO.	PRICE
CUTTING-OFF WHEELS							
	TYPE 41	350	4,0x25,4	ZA 24 Q Zirconia	10	66252830924	£000.00
		400	4,0x25,4	ZA 24 Q Zirconia	10	66252833665	£000.00

RAIL **++++**

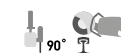

	TYPE	DIA (mm)	TxB (mm)	SPEC	PK QTY	ART NO.	PRICE
CUTTING-OFF WHEELS							
	TYPE 41	350	4,0x25,4	ZA 24 T Zirconia	10	66252832744	£000.00
			4,0x25,4	A 24 T Hard	10	66252829588	£000.00
			4,0x25,4	A 24 P Soft	10	66252828620	£000.00
			4,0x25,4	A 24 Q Medium	10	66252833554	£000.00
			400	4,0x25,4	A 24 P Soft	10	66252919130



CUTTING-OFF & GRINDING WHEELS FOR FOUNDRY

Cast iron used in foundry applications requires a specific type of cutting and grinding wheel to achieve a quick and clean cut. Norton Foundry X has been designed to remove the maximum material in the shortest time. Premium zirconia grains and heavy reinforcements ensure that Norton Foundry X performs on the most powerful machines and under pressure in the toughest circumstances.



FOUNDRY X **++++**

- Coarse zirconia grain for rough applications in the toughest environment
- Comfortable to use thanks to reduced vibration, a highly stable wheel
- The quickest way to cut castings on both electrical and high frequency grinders



METAL INOX
CAST IRON



	TYPE	DIA (mm)	TxB (mm)	SPEC	PK QTY	ART NO.	PRICE
	TYPE 41 	230	2,5x22,23	ZA24R FOUNDRY X	25	66252839355	£000.00
			2,5x22,23	ZAC24S FOUNDRY X	25	66252839350	£000.00
			3,4x22,23	ZAC24S FOUNDRY X	25	66252839351	£000.00
	TYPE 42 	125	3,4x22,23	ZA30S FOUNDRY X	25	66252839391	£000.00
			230	2,5x22,23	ZA24R FOUNDRY X	25	66252839356
		3,4x22,23		ZA20T FOUNDRY X Hard	25	66252839347	£000.00
		3,4x22,23		ZA30S FOUNDRY X Medium	25	66252839348	£000.00
		3,4x22,23		ZA24R FOUNDRY X Soft	25	66252839349	£000.00



METAL INOX
CAST IRON





	TYPE	DIA (mm)	TxB (mm)	SPEC	PK QTY	ART NO.	PRICE
COMBINATION WHEELS 	TYPE 27	230	4,0x22,23	ZA30S FOUNDRY X	25	66252839352	£000.00
			4,5x22,23	ZA30S FOUNDRY X	25	66252839354	£000.00

CUTTING-OFF & GRINDING WHEELS FOR FOUNDRY

FOUNDRY X **++++**

- New 180mm and 230mm Foundry X wheels are made with 4 layers of reinforcement to work under the highest side pressure without the risk of breakage
- For use on High Frequency machines for use in enduring applications in the toughest environments



	TYPE	DIA (mm)	TxB (mm)	SPEC	PK QTY	ART NO.	PRICE
GRINDING WHEELS							
		125	7,0x22,23	ZA24T LONG LIFE	10	66253371176	£000.00
		180	7,0x22,23	ZA24T LONG LIFE	10	66253371162	£000.00
			7,0x22,23	ZA20R COMFORT	10	66253370493	£000.00
		230	7,0x22,23	AC24Q FOUNDRY X	10	66252839353	£000.00
			7,0x22,23	ZA24T LONG LIFE	10	66253371175	£000.00
			7,0x22,23	ZA20R COMFORT	10	66252842546	£000.00



HF
OPTIMISED FOR HIGH FREQUENCY ANGLE GRINDERS

High Frequency machines will not reduce in revolutions when grinding pressure is increased. When using high pressure on standard or non-reinforced wheels and machines, the risk of wheel breakage is high. Also, under low pressure, non-reinforced wheels can show cracks due to fatigue within the abrasive running at high revolutions. High Frequency reinforced grinding wheels ensure safe working conditions in all circumstances.



DIALAST **++++** INNOVATION

- Long product life reduces downtime and wheel changes, reducing cost and increasing throughput
- Reduces dust and debris as fewer sparks are generated, minimising clean-up
- Diamond grit brazed to the face of the steel core decreases the risk of breakage for safer grinding



	TYPE	DIA (mm)	BORE (mm)	SPEC	PK QTY	ART NO.	PRICE
COMBINATION WHEELS							
		180	22,23	T27 G36	1	70184602080	£000.00
			22,23	T27 G50	1	70184602078	£000.00
		230	22,23	T27 G36	1	70184602081	£000.00
			22,23	T27 G50	1	70184602079	£000.00



	TYPE	DIA (mm)	BORE (mm)	SPEC	PK QTY	ART NO.	PRICE
GRINDING WHEELS							
		115	22,23	T29 G24	1	70184602070	£000.00
			22,23	T29 G50	1	70184602074	£000.00
		125	22,23	T29 G24	1	70184602071	£000.00
			22,23	T29 G50	1	70184602075	£000.00
		180	22,23	T29 G24	1	70184602072	£000.00
			22,23	T29 G50	1	70184602076	£000.00
		230	22,23	T29 G24	1	70184602073	£000.00
			22,23	T29 G50	1	70184602077	£000.00



CUTTING-OFF & GRINDING WHEELS FOR OFFSHORE & OIL INDUSTRY

The Norton Oil & Gas range has been specially designed for the most demanding applications and off-shore environments. The range is characterized by safety, performance and reliability.



OIL & GAS **++++**

- Long wheel life even in extreme, high pressure applications
- High material removal on high alloys and special steels
- Improved user comfort and supreme safety for use in maintenance and repair applications in off-shore and oil industries



METAL
INOX





	TYPE	DIA (mm)	TxB (mm)	SPEC	PK QTY	ART NO.	PRICE
	TYPE 41 	115	1,0x22,23	A 60 T	25	66252844792	€000.00
		125	1,0x22,23	A 60 T	25	66252844794	€000.00
			1,6x22,23	A 46 T	25	66252844795	€000.00
			2,5x22,23	A 46 T	25	66252844910	€000.00
		180	1,6x22,23	A 46 T	25	66252844796	€000.00
			2,5x22,23	A 46 T	25	66252844911	€000.00
		230	1,9x22,23	A 36 T	25	66252844797	€000.00
			2,5x22,23	A 36 T	25	66252844912	€000.00



METAL
INOX





	TYPE	DIA (mm)	TxB (mm)	SPEC	PK QTY	ART NO.	PRICE
	TYPE 27 	125	7,0x22,23	A 24 Q	25	66252844789	€000.00
		180	7,0x22,23	A 24 Q	25	66252844790	€000.00
		230	7,0x22,23	A 24 Q	25	66252844791	€000.00



METAL
INOX



	TYPE	DIA (mm)	TxB (mm)	SPEC	PK QTY	ART NO.	PRICE
	TYPE 27 	125	4,0x22,23	A 24 T	25	66252844815	€000.00
		180	4,0x22,23	A 24 T	25	66252844835	€000.00



CUTTING-OFF WHEELS FOR PETROL SAWS

Norton's cutting wheels for petrol saws provide high value and high performance in construction and demolition.

VULCAN **++++**

- General purpose cutting-off wheels for all petrol saw applications
- Straight, fast cutting throughout long wheel life



	TYPE	DIA (mm)	TxB (mm)	SPEC	PK QTY	ART NO.	PRICE
	TYPE 41	300	3,5x20,0	A 30 S	10	66252925457	£000.00
			3,5x22,23	A 30 S	10	66252925458*	£000.00
			3,5x25,4	A 30 S	10	66252925459*	£000.00

* Made-to-order

NORLINE **++++**

- Large diameter wheels for cutting steel, stone, brick and concrete
- Straight, fast cutting throughout long wheel life



	TYPE	DIA (mm)	TxB (mm)	SPEC	PK QTY	ART NO.	PRICE
	TYPE 41	350	3,8x20,0	A 24 T	10	66252829915	£000.00
			3,8x22,23	A 24 T	10	66252829916	£000.00





CUTTING-OFF WHEELS FOR CHOP SAWS

Norton's cutting wheels for chop saws provide high value and high performance in construction, fabrication, foundry and maintenance industries.

VULCAN

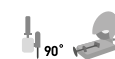
- Clean and straight cutting on portable chop saws and fixed machines
- Mechanical reinforcement for cutting metal and inox safely



	TYPE	DIA (mm)	TxB (mm)	SPEC	PK QTY	ART NO.	PRICE
CUTTING-OFF WHEELS							
		300	2,8x25,4	A 30 S	10	66252925460*	€000.00
		350	3,0x25,4	A 30 S	10	66252925462	€000.00
	TYPE 41		3,0x32,0	A 30 S	10	66252925463*	€000.00
		400	3,2x25,4	A 30 S	10	66252925464*	€000.00
			3,2x32,0	A 30 S	10	66252925465*	€000.00

* Made-to-order



CUTTING-OFF WHEELS FOR STATIONARY MACHINES

Norton's cutting wheels for stationary machines provide high value and high performance in construction, fabrication and foundry industries.

VULCAN **++++**

- Long wheel life with quick and free cutting
- Cuts without burning, blueing or splintering the metal
- Use under constant power in heavy cut-off applications
- Double, full external mechanical reinforcement for excellent safety and stability



	TYPE	DIA (mm)	TxB (mm)	SPEC	PK QTY	ART NO.	PRICE
CUTTING-OFF WHEELS							
		350	4,0x32,0	C 30 R	10	66252925483	£000.00
		400	4,5x32,0	C 30 R	10	66252925484	£000.00
		300	3,0x32,0	A 30 S	10	66252925466	£000.00
			3,0x32,0	A 30 S	10	66252925475	£000.00
			3,5x32,0	A 30 S	10	66252925468	£000.00
		350	3,5x25,4	A 30 S	10	66252925469	£000.00
			3,5x32,0	A 30 S	10	66252925470	£000.00
		400	4,0x25,4	A 30 S	10	66252925472	£000.00
			4,0x25,4	A 30 S	10	66252925477	£000.00
			4,0x32,0	A 30 S	10	66252925473	£000.00
			4,0x32,0	A 30 S	10	66252925478	£000.00
			4,5x32,0	A 30 S	10	66252925474	£000.00

STARLINE

- Dedicated for steel
- Good price/quality ratio
- Stable cut

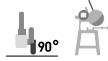



METAL 

	TYPE	DIA (mm)	TxB (mm)	SPEC	PK QTY	ART NO.	PRICE
CUTTING-OFF WHEELS							
		300	3,0x32,0	A 30 R	10	66252843841	£000.00
	TYPE 41	350	3,5x32,0	A 30 R	10	66252843842	£000.00
		400	4,0x32,0	A 30 R	10	66252843843	£000.00



TECHNICAL INFORMATION

SHAPE SPECIFICATION SYSTEM

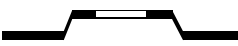
BF 27	BF 41	BF 42
		
DEPRESSED CENTRE GRINDING WHEELS	FLAT CUTTING-OFF WHEELS	DEPRESSED CENTRE CUTTING-OFF WHEELS
Available in diameters 76-230mm for hand-held machines.	Available in diameters 50-400mm for hand-held machines & 250-400mm for stationary machines.	Available in diameters 76-230mm for hand-held machines.
Application: grinding	Application: cutting-off	Application: cutting-off

METAL RING WITH VALIDITY DATE

V = VALIDITY DATE (PRODUCTION QUARTER + 3 YEAR)











V01	V04	V07	V10
1st quarter	2nd quarter	3rd quarter	4th quarter

EXAMPLE:

V04/2021 indicates production in the 2nd quarter of 2018 and advised usage before the 2nd quarter of 2021

PERSONAL PROTECTION

Safety goggles, ear defenders, safety gloves, dust masks and, if conditions are severe, additional face protection. Leather aprons and safety shoes must be worn.

- 
Mouth Protection
- 
Wear Gloves
- 
Eye Protection
- 
Ear Protection
- 
Read Instructions
- 
Damaged Wheel – Do Not Use
- 
Do not Grind
- 
Dry
- 
Do not use free handed

GENERAL PRECAUTIONS

Safety instructions provided by the machine manufacturers must be followed. Where fitted, all guards, covers and hoods must be in place on the machine during grinding, and should not be modified in any way. Abrasives should not be used near inflammable material or in an environment where there is a risk of explosion.



Sparks should be directed away from the face and body, if possible towards the floor. Dust extraction equipment must be used whenever it is available. The instructions for use given by the abrasive manufacturer must be followed e.g. 'Not to be used without a support', or 'Not to be used for wet grinding'. The workpiece must be firmly fixed before grinding starts. Check all abrasives visually before use and make certain that the product is suitable for the application. No modifications should be made to abrasive products after delivery.

When using a portable grinder always switch it off and allow the spindle to stop completely before putting the tool down.

OPERATING SPEEDS

Norton products are designed and tested for certain applications and operating speeds. Choose a wheel suitable for the application material. Suitable materials are indicated on the wheel label. Before mounting the grinding or cutting-off wheel on the machine, ensure that the operating speed of the machine does not exceed the maximum operating speed as it is marked on the product.

WHEEL DIAMETER (mm)	SPEED CONVERSION FOLLOWING EN 12413	
	MAXIMUM OPERATING SPEED (RPM) for resinoid bonded cutting-off & grinding wheels in handheld and stationary operations	
	80	100
50/51	30600	38200
63/65	24300	30250
76	20150	25150
100/102	15300	19100
115	13300	16650
125	12250	15300
150/152	10200	12700
180	8500	10650
230	6650	8350
250/254	6150	7650
300/305	5100	6400
350/356	4400	5500
400/406	3850	4800

SAFETY ADVICE

DOs

Always handle & store wheels carefully. Cutting-off wheels should be stacked horizontally & flat, preferably on a steel base plate. Depressed centre wheels should be placed on top of each other or stored in the original packaging
Always visually inspect all wheels before mounting for possible damage in transit
Always use a safety guard & ensure that it is correctly positioned & securely fitted. It should cover at least one half of the wheel & protect the operator in the unlikely event of a wheel breakage. NON-REINFORCED CUTTING-OFF WHEELS SHOULD ONLY BE USED ON FIXED MACHINES & SHOULD BE CORRECTLY GUARDED.
Always switch 'OFF' the power at supply source &/or remove the plug from the socket before changing the wheel
Always ensure that the spindle speed of the machine does not exceed the operating speed marked on the wheel
Always use the correct wheel mounting flanges & ensure that they are undamaged, clean & free from burrs
SEE EN 12413
Allow newly mounted wheels to run at operating speed, with the guard in place, for a reasonable time before cutting or grinding
Always wear EYE PROTECTION
Always wear appropriate safety clothing such as DUST MASK, GLOVES, EAR PROTECTION, OVERALLS & SAFETY SHOES
Always have machine speeds checked regularly, especially after maintenance or repair. Machines fitted with speed control devices (Governors), must be properly maintained at all times
Check tension of driving belts, where fitted, on a regular basis. Belts must be kept tight to ensure full power transmission.
Always secure the workpiece firmly while it is being cut or ground
Put portable machines in suitable cradles, when not being used, to avoid damage to the wheel
Always use a portable machine in a comfortable position, where the workpiece is well balanced & the machine is well supported
Grind at an angle above 30 degrees to the workpiece with a depressed centre grinding wheel
Keep the working area around cutting & grinding operations clear. It is very dangerous if an operator trips & falls with an operating machine in his hands

DON'Ts

Handle wheels roughly
Use non-reinforced cutting-off wheels on portable machines
Store wheels in a damp atmosphere or in extreme temperatures
Mount a damaged wheel
Tighten the mounting nut or locking flange excessively. To do so can distort the flanges
Force a wheel onto a machine spindle
Use mounting flanges which are incorrect, damaged, dirty or burred
Use blotters with depressed centre wheels less than or equal to 406mm (EN 12413)
Use a machine which is not in good mechanical condition
Use a machine without a wheel guard
Use wheels without proper ventilation or dust protection equipment
Apply side pressure to cutting-off wheels. You should not bend the wheel
Stop the wheel by applying pressure to the periphery or face. Always switch the machine off & allow the wheel to stop revolving
Allow the wheel to be trapped or pinched in the cut
Apply excessive pressure onto the wheel so that the driving motor slows down
Grind on the side of cutting-off wheels or depressed centre wheels below 4,0mm thickness
Drop or lower a portable machine by the cable or airline onto the floor. A wheel can be easily cracked, if it is put down hard, by the weight of the machine. This is a common cause of wheel breakage
Grind with a depressed centre grinding wheel at an angle below 30 degrees to the workpiece
Use a machine in a position where you do not have full control of the machine & you are not well balanced



NORTON

SAINT-GOBAIN®

COATED

COATED ABRASIVES

Introduction	40	WHEELS	107-142
DISCS FOR ANGLE GRINDERS	45-70	Flap wheels	108
Introduction	46	Convolute wheels	131
Fibre discs	49	Rapid Strip wheels	136
Flap discs	54	Rapid Blend unitised wheels	138
Semi-flexible discs	62	High strength discs	140
Rapid Strip	63	ROLLS	143-198
Rapid Blend	64	Handy rolls	144
Rapid Prep	66	Paper & cloth rolls	148
Polishing discs	69	Norton Meshpower	153
DISCS FOR MINI ANGLE GRINDERS	71-90	Beartex rolls	154
Speedlok discs	72	Rotolo Foam rolls	156
Mini Flap discs	77	SHEETS & SPONGES	199-172
Non-Woven Speedlok discs	80	Cut sheets	160
Rapid Strip Speedlok discs	81	Sheets & hand pads	163
Rapid Blend Speedlok discs	82	Norton Meshpower	167
Rapid Prep Speedlok discs	84	Beartex sheets & hand pads	169
Speedlok Buffing & Polishing discs	86	Abrasive sponges	171
DISCS FOR ORBITAL MACHINE	91-106	BELTS	173-198
Norton Meshpower discs	92	File belts	174
Self-Grip & Beartex discs	94	Portable belts	180
Screenback discs	103	Narrow belts	183
Plain discs	104	Rapid Prep belts	191
Beartex floor pads	106	SPECIALTIES	199-212
		Spirabands and Cones	200
		Cartridge and Spiral rolls	204
		Sanding stars	208

INDEX BY PRODUCT

DISCS FOR ANGLE GRINDERS

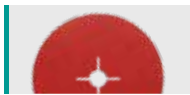

FIBRE DISCS
49



FLAP DISCS
54



RIGHT ANGLE GRINDER
APPLICATION KITS
59



CURVED FLAP DISCS
61



SEMI-FLEXIBLE DISCS
62



RAPID STRIP DISCS
63

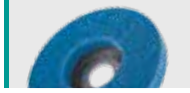

RAPID BLEND DISCS
64



RAPID PREP DISCS
66



POLISHING DISCS
69

DISCS FOR MINI ANGLE GRINDERS



MINI ANGLE GRINDER
SPEEDLOK DISCS
72



MINI ANGLE GRINDER
MINI FLAP DISCS
77



MINI ANGLE GRINDER
NON-WOVEN SPEEDLOK DISCS
80



MINI ANGLE GRINDER
RAPID STRIP SPEEDLOK DISCS
81



MINI ANGLE GRINDER
RAPID BLEND SPEEDLOK DISCS
82



MINI ANGLE GRINDER
RAPID PREP SPEEDLOK DISCS
84



MINI ANGLE GRINDER
SPEEDLOK BUFFING & POLISHING
86



MINI RIGHT ANGLE
GRINDER TOOLS & KITS
89

DISCS FOR ORBITAL MACHINE



MESHPOWER DISCS
92



SELF-GRIP &
BEARTEX DISCS
94



SCREENBACK DISCS
103



PLAIN DISCS
104

WHEELS



FLAP WHEELS
108



PNEUMATIC DIE GRINDER
GRINDING TOOLS AND KITS
119



CONVOLUTE WHEELS
131



RAPID STRIP WHEELS
136



RAPID BLEND
UNITISED WHEELS
138



HIGH STRENGTH DISCS
140

ROLLS



HANDY ROLLS
144



PAPER & CLOTH ROLLS
148

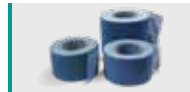

NORTON MESHPOWER
153



BEARTEX ROLLS
154



ROTOLO BEARTEX &
FOAM ROLLS
156

SHEETS & SPONGES



CUT SHEETS
160



SHEETS & HAND PADS
163

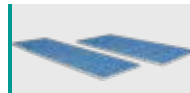

NORTON MESHPOWER
167



ABRASIVE SPONGES
171

BELTS



FILE BELTS
174



PORTABLE BELTS
180

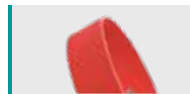

NARROW BELTS
183

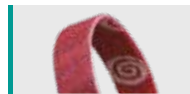

RAPID PREP BELTS
191

SPECIALTIES



SPIRABANDS & CONES
200



CARTRIDGE &
SPIRAL ROLLS
204



SANDING STARS
209

INDEX BY MACHINE TYPE

ANGLE GRINDER

Fibre Discs	49
Flap Discs	54
Semi Flexible Discs	62
Stripping & Cleaning	63
Blending	64
Finishing & Polishing	69



MINI GRINDER

Speedlok Discs	72
Mini Flap Discs	77
Stripping & Cleaning	81
Blending	82
Surface Preparation	84
Polishing	86

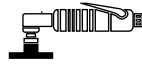

DIE GRINDER

Accessories for Die Grinder	89
Spindle Mounted Flap Wheels	108
Rapid Blend Unitised Wheels	138
Specialties	199



DISC SANDERS

Introduction	64
Self-Grip Discs	95
Beartex Self-Grip Discs	100
Backup Pads	101



ORBITAL STRAIGHT SHEET SANDER/SANDING BLOCK

Self-Grip Paper Rolls	148
Norton Meshpower Rolls	153
Beartex Rolls	154
Cut Sheets	160



HAND SANDING

Handy Rolls	144
Paper Rolls	148
Cloth Rolls	148
Rotolo Foam Rolls	156
Sheets & Hand Pads	163
Norton Meshpower Sheets	167
Beartex Sheets & Hand Pads	169
Abrasive Sponges	171



FILE BELT MACHINE

File Belts	174
Beartex Surface Blending File Belts	191



PORTABLE BELT SANDER

Portable Belts	180
----------------	-----



BACKSTAND MACHINE

Narrow Belts for Metal	184
Narrow Belts for Wood	189
Surface Blending Belts	194

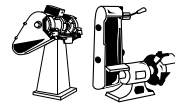

BENCH/PEDESTAL GRINDER

Flange Mounted Flap Wheels	127
Beartex Flange Mounted Flap Wheels	129
Rapid Finish Convolute Wheels	131
Convolute Wheels	131
High Strength Discs	140

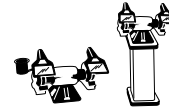

SATINEX MACHINE

Flap Wheels for Satinex Machines	123
Beartex wheels for Satinex Machines	125

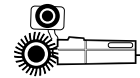

PRODUCTS FOR WALL, FLOOR & CEILING SANDING

Screenback Discs for Wall & Ceiling Sanding	103
Plain Discs	104
Beartex Floor Pads	106



SHOE REPAIR

Belts	176
Cones	200



GLASS APPLICATIONS

Portable Belts	180
Cloth Belts	189



† To help better describe the abrasive fixing system we have changed the name from 'NorGrip' to 'Self-Grip'.

INTRODUCTION

The Norton coated abrasive and Beartex product offering encompasses a complete range of belts, discs, rolls, sheets and flap wheels for all your polishing, welding, maintenance and repair operations needs.

This extensive product range includes products designed for all types of application, including heavy stock removal, dimensioning, grinding, deburring, cleaning, blending, polishing and finishing operations.

UNDERSTANDING THE PRODUCT

R	9	2	9
BACKING	PRINCIPAL ABRASIVE	COATED	RANDOM

BACKING

- A** - Light Paper
- F** - Fibre
- G** - Heavy Paper
- H** - Heavy Paper
- K** - Cloth
- Q** - Various
(e.g. Screenback & Film)
- R** - Cloth
- S** - Combination
- T** - Waterproof Paper
- U** - Norax
- W** - Special (Cork)

PRINCIPAL ABRASIVE

- 1** - Aluminium Oxide
- 2** - Aluminium Oxide
- 3** - Aluminium Oxide
- 4** - Silicon Carbide
- 6** - Emery
- 7** - Flint
- 8** - Zirconia Alumina
- 9** - SG - Ceramic
Aluminium Oxide

COATED

- Odd Number - Open coat
- Even number - Closed coat

RANDOM

Differentiates different products within the same product group

BACKING TYPES

Whether paper, cloth, vulcanised fibre or polyester film, the backing must be smooth enough for uniform adhesive coating, strong enough to withstand grinding pressures and flexible enough to conform to contours if necessary.

ABRASIVE TYPES

The ideal abrasive grain offers maximum resistance to point wear, yet fractures before serious dulling occurs, thereby satisfying both stock removal and finishing requirements.

ABRASIVE BONDS

There are two main types of adhesives in use, one based on animal glue, and the more common based on synthetic heat hardenable resins. The adhesive is applied with a minimum of two bonding applications. The first, or maker, coat adheres the abrasive grain to the backing ensuring proper anchoring and orientation. After drying, or curing, the second, or sizer, coat is applied. The sizer adhesive, united with the maker bond, provides final grain anchoring and the proper total adhesive level for the finished product.

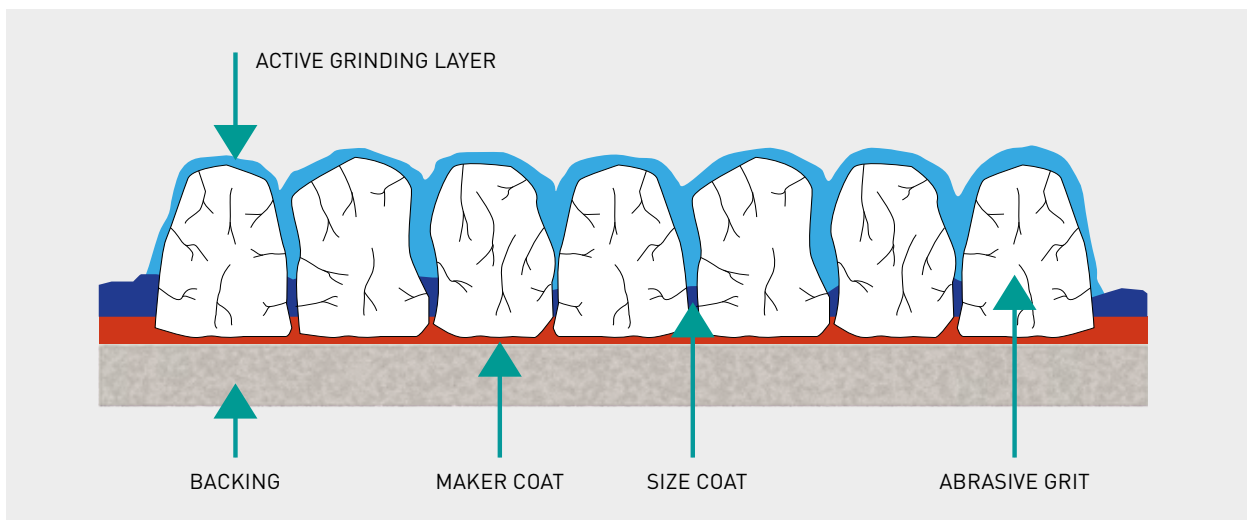

ABRASIVE GRAIN DISTRIBUTION

There are two types of abrasive grain coverage on the backing:

- Openly spaced distribution where between 30% and 60% of the backing is covered leaving large spaces between each abrasive grain. It is used in operations where the grinding swarf would otherwise 'load' or clog the surface, reducing cutting efficiency and shortening the coated abrasive life
- Closely packed grain distribution is where the grain completely covers the backing. The greater number of abrading points in a given area leads to faster stock removal. It is recommended where loading is not a problem and where smoother surface finishes are desired



OPEN COAT
(1/3 LESS GRAIN THAN CLOSED)

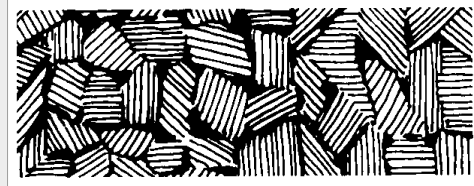

CLOSED COAT





SPECIAL COATED SURFACE TREATMENT NO-FIL TREATMENT

In order to provide even further resistance to loading, some Opencoat paper products are given a special surface treatment of zinc stearate after the sizing operation. Such products are ideal for sanding between sealer coats on furniture, sanding after primer coats on automobiles,

removing varnish from wood, and numerous other operations where conventional abrasive products fail prematurely due to loading.

Norton's trademark for products utilising this treatment is No-Fil.

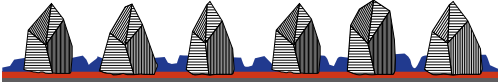
ABRASIVE GRAIN TYPES

GRAIN TYPE	BOND / TOUGHNESS	STRUCTURE	PROPERTIES / WEAR PROPERTIES
SILICONE CARBIDE (SIC)	Very hard / less tough	Crystalline	Sharp-edged, brittle, highly friable / micro wear 
ALUMINIUM OXIDE	Hard / tough	Crystalline, irregular	Wedge-shaped, block grain, even wear 
ZIRCONIA ALUMINA	Hard / very tough	Crystalline, even	Wedge-shaped, block, drop formed grit / micro wear, self-sharpening 
CERAMIC ALUMINIUM OXIDE	Hard / very tough	Micro crystalline	Sharp-edged, pointed grit / micro wear, self sharpening 

COATED ABRASIVES

NATURAL ABRASIVES

Emery is a natural composite of corundum and iron oxide. The particles are blocky in shape and tend to cut slowly, thereby producing a polishing action on the material being abraded. Used for general maintenance

and polishing of metals and in very fine grits for highly technical polishing, such as preparing metallurgical specimens requiring very close tolerances. Emery products are black in colour.

SYNTHETIC ABRASIVES

- Aluminium oxide is tough and well adapted to grinding high tensile materials, such as carbon steel, alloy steels, tough bronze and hard woods. Wherever toughness (ability to resist fracturing) is the main consideration, aluminium oxide out performs all other coated abrasive grains
- Silicon carbide is the hardest and sharpest of the minerals used in coated abrasives. Its hardness and sharpness make it the ideal abrasive for sanding non-ferrous metals (aluminium, brass, bronze, magnesium, titanium, etc.), rubber, glass, plastics, fibrous woods, enamel and other relatively soft materials. Silicon carbide is superior to any other abrasive in its ability to penetrate and cut faster under light pressure
- Zirconia alumina has a unique self-sharpening characteristic which gives it long life on rugged stock removal operations. Zirconia alumina is well suited for heavy grinding of metals and planing of wood, because the controlled fracturing of the grain continuously produces sharp, new abrading points
- Ceramic aluminium oxide is a long-lasting, tough, dense abrasive due to its micro structure. The extremely small micron size particles break off during grinding, producing multiple new cutting edges. As it stays sharp, especially when used in medium and high pressure operations, it cuts at a higher rate than other abrasives. Recommended for use on forged and carbon steels, high nickel and cobalt alloys.



BACKING TYPES

Whether paper, cloth, vulcanised fibre, a combination or polyester film, the backing must be smooth enough for uniform adhesive coating, strong enough to withstand grinding pressures and flexible enough to conform to contours (if necessary). For reasons of economy, the least expensive backing compatible with the job requirements should be selected.

PAPER

The standard paper weights used in coated abrasives are indicated by a letter code which appears immediately after the grit size on the finished product backing. Briefly stated, the lighter the backing, the greater the degree of flexibility; the heavier the backing, the greater the resistance to tearing.

A-WEIGHT (70gms)

Light and flexible, A-weight is used primarily for hand finishing operations both wet and dry. Grits 80 and finer.

C-WEIGHT (120gms)

Stronger and less flexible than A-weight. This backing is chosen for hand sanding, dry or wet, and for use on small portable power sanders. Intermediate through fine sanding. Grits 60 through 180.

D-WEIGHT (150gms)

Stronger and less flexible than C-weight. This backing is also chosen for hand sanding and for use on small portable power sanders. Coarse through intermediate sanding. Grits 36 through 80.

E-WEIGHT (220gms)

Stronger and less flexible than D-weight, this backing is used primarily on roll, belt and disc applications where high resistance to tearing is needed.

F-WEIGHT (300gms)

The strongest, least flexible paper backing utilised. Used for crankshaft lapping rolls, tannery industry belts and rolls, and NorZon belts only.

FIBRE

Fibre backings, made of multiple layers of impregnated paper, are very hard and strong, yet provide sufficient flexibility for the intended applications. 0,8mm thick fibre has the greatest strength of any backing used for coated abrasives. This backing is used on resin bonded fibre discs designed for heavy duty portable grinding applications

COMBINATION

Combination backing, constructed by laminating light cloth and stiff E-weight paper, is used where resistance to tearing and breaking is a requirement. Primarily utilised on products designed for chipboard/MDF sanding.

CLOTH

Cloth backings are more durable than paper, offer greater resistance to tearing, and tolerate continual bending and flexing during use. Norton use traditional woven cloth in the manufacture of their coated abrasives. The backing has construction and finishing characteristics designed to make it ideally suited to a specific application. The standard cloth weights used in coated abrasives are indicated by a letter code which appears immediately after the grit size on the finished product backing.

J-WEIGHT

The lightest and most flexible cloth backing, this backing is used where finish and uniformity of the surface are more important than stock removal. Ideal for finishing, blending and where flexibility and conformity are required, such as contour work or curved surfaces.

X-WEIGHT

Stronger and relatively stiff when compared to J-weight, this backing is used on products designed for coarse grit stock removal applications through fine grit finishing and polishing. Consistent productivity, relatively good finishes and long product life are characteristics of products made on X-weight backings.

Y-WEIGHT

Stronger and more resistant to longitudinal splitting than regular drills cloth, Y-weight backing is used on products designed for severe applications, such as narrow belt grinding of hand tools and wide belts sanding of lumber and particleboard dimensioning

FILM

Polyester is used as the backing media for Norton's range of precision graded microfinishing products. Film backings can be used wet or dry and have excellent resistance to chemical attack, while being tear resistant and durable.

INTRODUCTION TO BEARTEX NON-WOVEN PRODUCTS

Beartex consists of a backing in “non-woven” nylon fibers evenly impregnated with abrasive granules through the binding action of synthetic resins. This structure forms a “three-dimensional” abrasive material. Since this product was created as a finishing tool for operations where no material need be removed, it is particularly suitable for buffing-up purposes or to reduce the roughness of a

surface: BearTex begins to act when other abrasive tools have terminated their work. In all those situations where a buffing, cleaning or finishing operation is required, the BearTex product is decidedly a must.

UNDERSTANDING THE NON-WOVEN CAP CODE SYSTEM

RapidFinish Convolute S/C (Silicon Carbide) FINE		C	4	4	15
MARKETING PRODUCT NAME	MARKETING CAP CODE FAMILY	TYPE OF MATERIAL	GRAIN	GRADE	INTERNAL DIFFERENTIATION
Bear-Tex	Flat Stock	F	0 - No Grain	0 - No Grit	Consecutive numbers used for internal differentiation
Rapid Blend-Unified	Utitized / Unified	U	1 - A/O White	1 - Extra Coarse	
Rapid Strip	Rapid Strip	R	2 - A/O Brown	2 - Coarse	
Rapid Prep-Surface Conditioning	SCM Surface Conditioning Material / Blending	S	4 - S/C	3 - Med.	
Rapid Finish-Convolute	Convolute	C	5 - Garnet	4 - Fine	
Floor pads	Floor Maintenance	JF	7 - Diamond 9 - Ceramic	5 - Very Fine 6 - Ultra Fine 7 - Super Fine 8 - Micro Fine	

USED WET OR DRY, BEARTEX PRODUCTS OFFER THE FOLLOWING ADVANTAGES:

- A predictably consistent, uniform finish
- Minimum smearing and discolouration of the work-piece as heat is dissipated through the open mesh of the product
- Increased productivity through savings in time
- Ability to automate operations
- Reduced operator training
- Less maintenance required
- Greater safety than other methods
- Conformability to irregular surfaces

These advantages make Beartex products an excellent alternative to bristle brushes, set-up wheels, greaseless compounds, and steel wool. Operators quickly learn the techniques of using Beartex products to produce eye catching finishes.

BEARTEX PRODUCTS CAN BE USED ON A WIDE VARIETY OF SURFACES

- Aluminium
- Chromium
- Tantalum
- Fibreglass
- Brass
- Stainless Steel
- Ceramics
- Wood
- Copper
- Zinc
- Glass
- Plywood
- Nickel
- Titanium
- Plastic

APPLICATIONS INCLUDE

- Deburring
- Blending
- Defuzzing plywood
- Decorative finishes
- Cleaning
- Polishing
- Dulling laminates
- Scrubbing
- Highlighting
- Imparting satin
- Scouring
- Deflashing plastics
- Removing raised wood fibres



NORTON

SAINT-GOBAIN

COATED
ABRASIVES

DISCS FOR ANGLE GRINDERS

Introduction	46	Semi-flexible discs	62
Fibre discs	49	Rapid Strip	63
Flap discs	54	Rapid Blend	64
Curved flap discs	61	Rapid Prep	66
		Polishing discs	69



COATED ABRASIVE DISCS FOR ANGLE GRINDERS

Norton has a complete range of high performance Flap and Fibre discs available in premium performance Norton SG ceramic aluminium oxide, zirconia alumina, silicon carbide, and aluminium oxide abrasives. For everything from heavy-to-medium stock removal, to fine finishing, to light blending and polishing, coated abrasive Flap and Fibre discs are available in many shapes, abrasive grains, specialty coatings and backing configurations to meet many application needs.

From within our range you will find the perfect Coated disc for every Performance/Price Level, supported by a wide range of Accessories to optimise your choice.

We have provided Selection Guides and charts to help you find the right product for your needs and don't forget our new Innovations highlighted throughout this powerful range. We also included SPEC Checks to provide you with helpful hints and tips when using the products.

WHY CHOOSE FLAP DISCS?

Flap discs are a versatile abrasive tools that can be used for applications ranging from stock removal to blending.

FLAP DISCS VS. GRINDING WHEELS

- Faster stock removal
- Smoother finish, no gouging
- Cooler cutting, less glazing
- Lightweight, easier to control
- Less vibration, less operator fatigue
- Reduced noise

FLAP DISCS VS. FIBER DISCS

- 20X longer life, reduced abrasive cost
- Fewer disc changes, reduced labour cost
- More consistent finish
- No back-up pad required
- Easier storage, no curling
- Reduced loading
- Use flap discs one grit size coarser than fibre discs, except in 40 grit.



NON-WOVEN DISCS FOR ANGLE GRINDERS

Non-woven discs for angle grinders have three components: strong synthetic fibre mesh and quality abrasives, bonded together by a smear-resistant adhesive. Rapid Strip discs have an open web construction that enables aggressive cutting action while maintaining a cool, non-loading surface. Rapid Blend discs have a unitized construction with varying weave – from open to tighter – for deburring and finishing. Rapid Prep discs have a more open weave that excels in surface preparation and cleaning. Each product provides excellent cutting action while improving surface finish.

WHY CHOOSE NON-WOVEN DEPRESSED CENTRE DISCS?

NON-WOVEN RIGHT ANGLE DISCS VERSUS FIBRE DISCS, WIRE BRUSHES AND DEPRESSED CENTRE WHEELS

- Deburring, blending and finishing with one product to reduce the number of steps
- Provides a controlled, sustained finish
- Prevents undercutting and gouging
- Provides a cooler grinding action to lessen the chance of warping or discolouration
- Ideal when loading is an issue, on fibreglass, adhesives and soft metals
- For stripping coatings and paint off of hard materials like concrete, cement and stone
- Less vibration and quieter for high operator acceptance
- Provides an alternative to wire brushes

RECOMMENDATION GUIDE FOR NON-WOVEN DISCS ON ANGLE GRINDER

APPLICATION	HIGHEST PRODUCTIVITY. LOWEST TOTAL COST	EXCELLENT BLEND OF PERFORMANCE & PRICE	CONSISTENT PERFORMANCE. LOW INITIAL PRICE
	+++++	++++	+++
Removing scale and coarse welding marks	Blaze Rapid Strip Ceramic extra coarse	-	
Removing coatings, epoxy/glue, paint		-	
Removing rust, oxidation, corrosion and residue		-	Rapid Strip S/C extra coarse
Removing parting lines and seams on fiberglass parts		-	
Removing paint/graffiti from concrete/stone		-	
Removing weld marks and weld splatter	-		Rapid Prep A/O coarse
Stainless steel deburring and cleaning	-	Vortex Rapid Blend 5A medium	Rapid Prep A/O coarse
Removing small flashings and parting lines	-		Rapid Prep A/O coarse
Surface preparation before coatings/plating	-	Vortex Rapid Prep A/O medium	Rapid Prep A/O medium
Light cleaning	-	Vortex Rapid Prep A/O medium	Rapid Prep A/O medium
Cleaning and preparing welds	-	Vortex Rapid Prep A/O fine	Rapid Prep A/O fine
Removing blemishes after welding stainless steel	-	Vortex Rapid Prep A/O fine	Rapid Prep A/O fine
Blending and finishing all metal parts	-	Vortex Rapid Prep A/O very fine	Rapid Blend NEX 2SF
Creating decorative finishes on stainless steel	-	Vortex Rapid Prep A/O very fine	Rapid Blend NEX 2SF
Final finishing and polishing	-	Vortex Rapid Prep A/O very fine	Rapid Blend NEX 2SF
Final finishing/polishing where high conformability is needed	-	-	Rapid Blend NEX 2SF





FIBRE DISCS FOR ANGLE GRINDERS

From rapid weld grinding to blending and finishing, Norton has a complete range of high performance fibre discs available in premium performance Norton SG ceramic aluminium oxide, zirconia alumina, silicon carbide, and aluminium oxide abrasives.

PRODUCT SELECTION GUIDE

Highly recommended ●
Recommended ○



MATERIALS	NORTON QUANTUM F996	NORZON F827	METAL F100
	++++	++++	+++
Stainless steel, inox	●	○	
Titanium, inconel & super alloys	●	○	
Carbon, construction & mild steel	●	●	○
Cast iron	○	●	○
Non-ferrous metal (brass/aluminium)		○	○
Hard wood		●	○

PRODUCT COMPARISON CHART

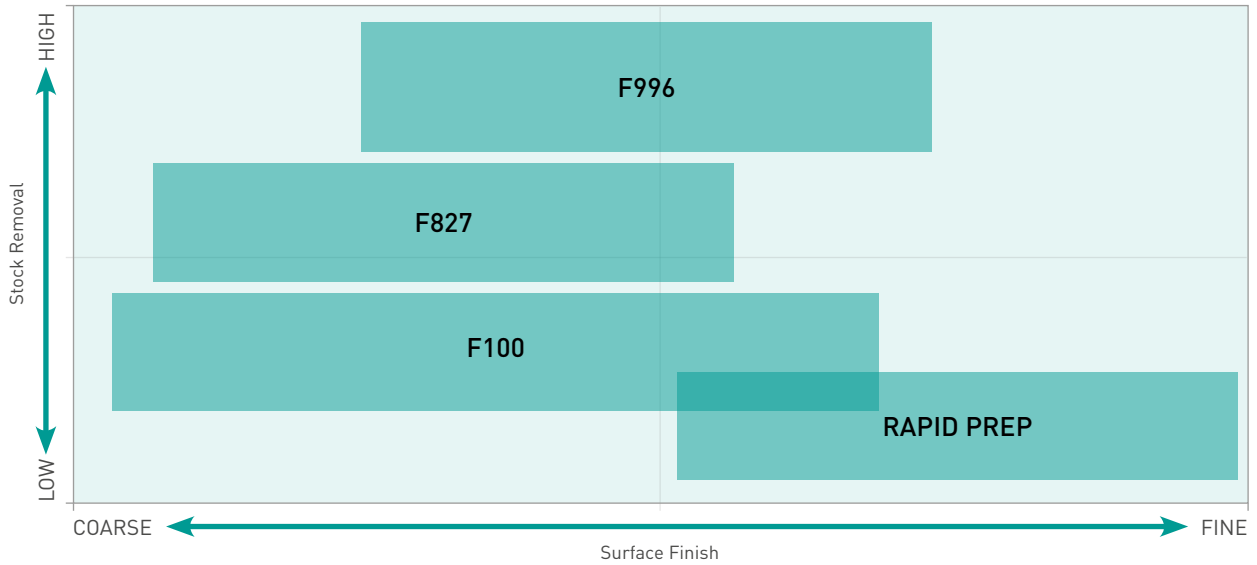

NORTON QUANTUM F996 **+++++**

- Ideal for cool grinding on stainless steel and heat-resistant steels
- Especially suitable for heavy duty applications
- Exceptionally high material removal & long life
- Generates an excellent surface finish



Grinding on stainless generates a considerable amount of heat; always use a Norton Quantum disc with 'supersize' layer, a grinding aid added to the disc to reduce heat generation and improve cut and finish quality. Typically, a coarse grit disc is used when grinding MIG welds and a finer grit disc is used when grinding TIG welds.

SIZE (mm)	GRIT	PK QTY	ART NO.	PRICE
115x22	36	25	66623327494	£000.00
	50	25	66623327496	£000.00
	60	25	66623327497	£000.00
	80	25	66623327499	£000.00
	120	25	66623327500	£000.00
125x22	36	25	66623327501	£000.00
	50	25	66623327502	£000.00
	60	25	66623327503	£000.00
	80	25	66623327504	£000.00
	120	25	66623327505	£000.00
NEW SIZE 150x22	36	25	66623381328	£000.00
	60	25	66623399637	£000.00
180x22	80	25	66261138545	£000.00
	36	25	66623327506	£000.00
	50	25	66623327507	£000.00
	60	25	66623327508	£000.00
	80	25	66623327509	£000.00
	120	25	66623327510	£000.00

NORZON F827

- High stock removal rate for rough grinding and deburring of steel and stainless steel
- High & regular cut rate at medium pressures
- Norzon abrasive with self-sharpening effect
- Excellent price-performance ratio



	SIZE (mm)	GRIT	PK QTY	ART NO.	PRICE
	115x22	24	25	69957360048	£000.00
		36	25	63642539615	£000.00
		50	25	69957360053	£000.00
		60	25	63642539616	£000.00
		80	25	63642539617	£000.00
		120	25	63642533055	£000.00
	125x22	24	25	63642539619	£000.00
		36	25	63642536483	£000.00
		50	25	63642539620	£000.00
		60	25	69957360057	£000.00
		80	25	63642539622	£000.00
		100	25	63642536484	£000.00
	180x22	24	25	63642533062	£000.00
		36	25	63642533063	£000.00
		50	25	63642533064	£000.00
		60	25	63642533065	£000.00
		80	25	63642533066	£000.00
		120	25	63642533068	£000.00



Using a supersized disc is not necessary on carbon steel due to less heat generated than that produced on stainless steel. Mild steels are much softer so the abrasive disc will last longer. Norton Norzon fibre discs are the better choice for carbon steel.

F100 METAL

- Versatile abrasive fibre discs for processing steel and metal alloys
- Increased stock removal rate for rough grinding and deburring
- Tough & versatile aluminium oxide abrasive
- Wide selection of grit sizes and diameters



	SIZE (mm)	GRIT	PK QTY	ART NO.	PRICE
	115 x 22	16	25	66623385735	£000.00
		24	25	66623385738	£000.00
		36	25	66623385741	£000.00
		40	25	66623385745	£000.00
		50	25	66623385747	£000.00
		60	25	66623385748	£000.00
		80	25	66623385750	£000.00
		100	25	66623385751	£000.00
		120	25	66623385757	£000.00
			125 x 22	16	25
24	25			66623385764	£000.00
36	25			66623385768	£000.00
40	25			66623385770	£000.00

FIBRE DISC BACK-UP PADS FOR ANGLE GRINDERS

SIZE (mm)	GRIT	PK QTY	ART NO.	PRICE
125 x 22	50	25	66623385773	£000.00
	60	25	66623385775	£000.00
	80	25	66623385776	£000.00
	100	25	66623385778	£000.00
	120	25	66623385779	£000.00
180 x 22	16	25	66623385755	£000.00
	24	25	66623385758	£000.00
	36	25	66623385760	£000.00
	40	25	66623385752	£000.00
	50	25	66623385793	£000.00
	60	25	66623385749	£000.00
	80	25	66623385746	£000.00
	100	25	66623385744	£000.00
	120	25	66623385739	£000.00



AIR COOLED BACK-UP PADS

- For tougher grinding operations
- Hard pad with cooling ribs for improved disc life
- Grits 16+ and finer

SIZE (mm)	THREAD	DENSITY	MAX. RPM	PK QTY	ART NO.	PRICE
115	M14	Rigid	13300	1	69957382821	£000.00
125	M14	Rigid	12200	1	69957382823	£000.00
180	M14	Rigid	8500	1	69957382824	£000.00
	5/8	Rigid	8500	1	63642588243	£000.00



NYLON FIBREGLASS REINFORCED BACK-UP PADS

- The curved ribs keep the pad and abrasive cooler while retaining a level of flexibility across the pad.
- For tougher grinding operations
- Conforms ISO 15636
- Grits 36+ and finer

SIZE (mm)	THREAD	DENSITY	MAX. RPM	PK QTY	ART NO.	PRICE
115	M14	Hard	13300	5	66623376727	£000.00
125	M14	Hard	12200	5	66623376821	£000.00
	5/8	Hard	12200	5	66623377068	£000.00
150	M14	Hard	10200	5	69957309184	£000.00
180	M14	Hard	8500	5	66623376822	£000.00
	5/8	Hard	8500	5	66623377069	£000.00



NYLON BACK-UP PADS

- For universal use
- Conforms to ISO 15636
- Grits 60+ and finer

SIZE (mm)	THREAD	DENSITY	MAX. RPM	PK QTY	ART NO.	PRICE
115	M14	Hard	13300	5	69957382828	£000.00
	M14	Medium	13300	5	69957382825	£000.00
125	M14	Hard	12200	5	69957382829	£000.00
	M14	Medium	12200	5	69957382826	£000.00
180	M14	Hard	8500	5	69957382830	£000.00
	5/8	Medium	8500	5	63642588345	£000.00
	M14	Medium	8500	5	69957382827	£000.00



FIBRE DISC BACK-UP PAD DENSITY GUIDE



RIGID suitable for tough grinding operations & where very high stock removal is required such as chamfering.



HARD DENSITY suitable for coarse applications and higher stock removal such as chamfering, welded seam or deburring work.



MEDIUM DENSITY suitable for medium/fine applications such as edge rounding or surface grinding.



FLAP DISCS FOR ANGLE GRINDERS

Norton flap discs are engineered for light stock removal, edge chamfering, deburring, blending and finishing, reducing processing time and lowering total abrasive costs. Flap discs cut faster and provide a better finish than fibre discs while having the added benefit of longer life thanks to the flap construction.

PRODUCT SELECTION GUIDE

Highly recommended ●
Recommended ○



MATERIALS	N QUANTUM MP R928	N QUANTUM R996	NORSTAR QC RX22/R822	VULCAN R842	VULCAN R265D	STARLINE R82A/B
	+++++	+++++	+++++	++++	++++	+++
Stainless steel, inox & duplex	●	●	○	○		
Inconel, titanium & super alloys	●	●	○	○		
Carbon, construction & mild steels	●	●	●	●	●	○
Cast Iron	○		●	●	●	●
Non-ferrous metal (brass/aluminium)					○	●
Hard & soft wood					●	●

DISC SHAPES

TYPE 29 CONICAL



- For both contoured surfaces & edge work
- Angled flaps provide greater contact when removing stock on flat surfaces
- The best choice for fast stock removal

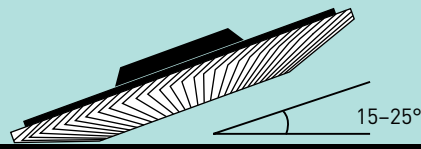

TYPE 27 FLAT



- For use on flat surfaces
- Best choice for blending & finishing

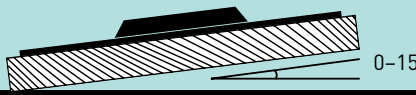



NORTON QUANTUM MAXIMUM PERFORMANCE R928

Norton Quantum R928 pink high performance flap discs, with polycotton cloth backing and ceramic grain, provide an improved cut rate and product life compared to both premium zirconium discs and ceramic products in the market, thanks to its high density configuration.

These discs also feature an additional supersize layer for cooler cutting, reducing heat generation during use for better part quality first and every time.

Norton Quantum R928 is ideal for fast grinding when used at medium pressure on stainless steel or harder metals.



Grinding on stainless steel generates a considerable amount of heat; always use a Norton Quantum disc with 'supersize' layer, a grinding aid added to the disc to reduce heat generation and improve cut and finish quality. Typically, a coarse grit disc is used when grinding MIG welds where a finer grit disc is used when grinding TIG welds.



FIBRE GLASS BACKED	SIZE (mm)	GRIT	PK QTY	CONICAL	
	115 x 22	40	10	66261143333	£000.00
		60	10	66261143336	£000.00
		80	10	66261143337	£000.00
		120	10	66261143338	£000.00
	125 x 22	40	10	66261143339	£000.00
		60	10	66261143340	£000.00
		80	10	66261143341	£000.00
		120	10	66261143343	£000.00
	180 x 22	40	10	66261143344	£000.00
		60	10	66261143345	£000.00
		80	10	66261143346	£000.00
		120	10	66261143347	£000.00



For heavy & fast material removal, has long life



Perfect for fast edge chamfering and de-burring



Supersize layer for a cooler cut & reduced heat generation during use, providing better part quality and no burn marks

FLAP DISCS FOR ANGLE GRINDERS

NORTON QUANTUM R996 **+++++**

- Ideal for cool grinding on stainless steel
- Extremely aggressive ceramic grain for noticeably faster cut rate
- Strong polyester backing for demanding work on edges
- Especially suitable for high pressure applications on high power angle grinders

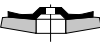
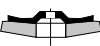

FIBRE GLASS BACKED	SIZE (mm)	GRIT	PK QTY	ART NO.	PRICE
	115x22 	40	10	66254461027	£000.00
		60	10	66254461029	£000.00
		80	10	66254461031	£000.00
	125x22 	40	10	66254445878	£000.00
		60	10	66254445879	£000.00
		80	10	66254461033	£000.00

NORSTAR QUICK CUT RX22/R822 **+++++**

- Ideal for cool grinding on carbon steel or stainless steel
- Aggressive stock removal with less pressure, reduces heat generation
- Suitable for medium pressure applications
- Special flap configuration with premium SG ceramic aluminium oxide & Norzon zirconia alumina abrasive blend

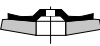
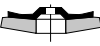

FIBRE GLASS BACKED	SIZE (mm)	GRIT	PK QTY	ART NO.	PRICE
	115x22 	40	10	63642534667	£000.00
		60	10	63642534668	£000.00
		80	10	63642534669	£000.00
		120	10	63642534670	£000.00
	125x22 	40	10	63642563571	£000.00
		60	10	63642568611	£000.00
		80	10	63642549404	£000.00
		120	10	63642550474	£000.00



The special double flap construction, combining premium SG ceramic aluminium oxide & Norzon zirconia alumina abrasive flaps, delivers aggressive stock removal with less pressure, even on medium power angle grinders.







VULCAN R842 **++++**

- Versatile product for rough grinding and deburring on steel and stainless steel
- Self-sharpening zirconium abrasive grain
- High & regular cut rate at medium and low pressures
- Excellent price-performance ratio



FIBRE GLASS BACKED

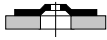

SIZE (mm)	GRIT	PK QTY	ART NO.	PRICE
115 x 22 	40	10	63642502311	£000.00
	60	10	63642502312	£000.00
	80	10	63642502313	£000.00
	120	10	63642502314	£000.00
125 x 22 	40	10	63642502315	£000.00
	60	10	63642502317	£000.00
	80	10	63642502318	£000.00
	120	10	63642502326	£000.00
150 x 22 	40	10	63642502327	£000.00
	60	10	63642502328	£000.00
	80	10	63642502329	£000.00
180 x 22 	40	10	63642502341	£000.00
	60	10	63642502343	£000.00
	80	10	63642502345	£000.00
115 x 22 	40	10	63642502331	£000.00
	60	10	63642502332	£000.00
125 x 22 	40	10	63642502335	£000.00
	60	10	63642502336	£000.00
	80	10	63642502337	£000.00



Using a supersized disc is not necessary on carbon steel as less heat is generated than that produced on stainless steel. Mild steels are much softer so the abrasive disc will last longer. Norton Norzon fibre discs are the better choice for carbon steel.



FLAP DISCS FOR ANGLE GRINDERS

VULCAN R265D

- Versatile product for rough grinding and deburring on steel and non-ferrous metals
- Fast initial cut rate especially on carbon steel
- Tough and durable aluminum oxide abrasive grain
- Good material removal on low or medium power angle grinders



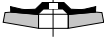
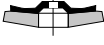
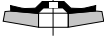

FIBRE GLASS BACKED	SIZE (mm)	GRIT	PK QTY	ART NO.	PRICE	
	 115x22	40	10	63642589240	£000.00	
		60	10	63642589241	£000.00	
		80	10	63642589242	£000.00	
	 125x22	40	10	63642589243	£000.00	
		60	10	63642589253	£000.00	
		80	10	63642589254	£000.00	
	 180x22	60	10	63642589255	£000.00	
		80	10	63642589256	£000.00	
		120	10	66623398833	£000.00	
			60	10	66623398835	£000.00
			80	10	66623398823	£000.00
			120	10	66623398824	£000.00

STARLINE R82A/B

- Versatile abrasive flap discs for processing steel and metal alloys
- High stock removal in rough grinding and Deburring
- Tough & versatile aluminium oxide abrasive
- Wide selection of grit sizes and diameters

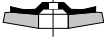

FIBRE GLASS BACKED	SIZE (mm)	GRIT	PK QTY	ART NO.	PRICE
	 115x22	40	10	66254492267	£000.00
		60	10	66254492268	£000.00
		80	10	66254492270	£000.00
		120	10	66254492269	£000.00
	 125x22	40	10	66254492271	£000.00
		60	10	66254492272	£000.00
		80	10	66254492273	£000.00
		120	10	66254492274	£000.00



For an equivalent finish, always use a flap disc one grit size coarser than with a fibre disc



NEW 4 STEP KIT FOR RIGHT ANGLE GRINDERS FROM CUTTING-OFF TO WELD SEAM REMOVAL

An assortment of Norton abrasive discs for angle grinders, of the most popular grades for cutting-off, cleaning, beveling and weld seam removal on carbon steel applications.

KIT CONTENTS	ITEM ART NO.	PK QTY	KIT ART NO.	PRICE
Norton Quantum3 cutt-off wheel NQ60ZZ-125x1.3x22.23-T41	66253371351	25		
Blaze Rapid Strip disc 125x22 R9101 AOXC	66623303916	10		
Norzon Fibre disc 125x22 P36	63642536483	25	69957366032	£000.00
Vulcan Zirconia flap discs 125x22 P60	63642502317	10		
Nylon fibreglass reinforced Back-up pad for fibre discs 125 M14	66623376821	1		
Norton professional tool bag: Polybag 600D 38x23x28cm	-	1		

WELD PREPARATION AND FINISHING IN 4 STEPS (CARBON STEEL)



STEP 1 CUTTING-OFF

Norton Quantum3 cutting-off wheels are easy to use, easy to steer and deliver consistent results. No dust, no smell so the process is more comfortable.

Norton Quantum3 is a very comfortable disc to use, offering the longest life on the market.



STEP 2 CLEANING

Blaze Rapid Strip discs are best used at a 10-15° angle to quickly eliminate unwanted coatings and corrosion, with minimal stock removal. It's a truly versatile product, as you can achieve a more aggressive action as you increase the pressure. It's comfortable to use without damaging or gouging components.

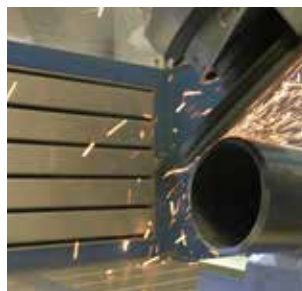

STEP 3 BEVELLING

Norton Norzon F827 Fibre discs in P36 combined with a hard serrated back-up pad is the best option. It'll remove material quickly, and the flat contact area makes it easy to control and help generate the required angle.



STEP 4 WELD SEAM REMOVAL

After welding use a Norton Vulcan R842 in grit P60 to quickly remove the weld seam and generate a finish ready for paint or other surface coatings.



NEW 3 STEP KIT FOR RIGHT ANGLE GRINDERS FROM WELD REMOVAL TO A BRIGHT FINISH

An assortment of Norton abrasive discs for angle grinders, of the most popular grades for stock removal, blending & refining and finishing on stainless steel applications.



KIT CONTENTS	ITEM ART NO.	PK QTY	KIT ART NO.	PRICE
Quantum flap discs 125x22 P60	66254445879	10		
Rapid Prep discs 125x22 Coarse	66623378975	25		
Rapid Blend discs 125x12x22 Fine	66254496320	10	69957366033	£000.00
Medium plain non-woven back-up pad 125 M14	69957382841	1		
Norton professional tool bag: Polybag 600D 38x23x28cm	-	1		

WELD REMOVAL TO A COMMERCIAL FINISH IN 3 STEPS (STAINLESS STEEL)



STEP 1 STOCK REMOVAL

Norton Quantum flap disc in grit P60 is ideal for weld and stock removal. Flap discs are particularly suited to this application as the constant erosion of the backing allows new, sharper grain to be exposed during use, offering longer product life. As the backing is softer than that of a fibre disc, the surface finish will be better, reducing the number of further steps.



STEP 2 BLENDING & REFINING

Vortex Rapid Prep (SCM) Discs are comfortable to use with finer finishing capabilities. Discs are best used at an angle of 10-15° preventing scratch patterns. A coarse grade disc is used to enable us to refine the finish from step 2.



STEP 3 FINISHING

Rapid Blend NEX-2SF has excellent final finishing capabilities and imparts an extremely fine, bright and shiny surface. It's best used at a 10-15° angle and needs to be moved slowly across the workpiece, using just the weight of the angle grinder for pressure. Also try NEX-3SF spec for more durability when flexibility and comfortability is less of a concern. For best results and to avoid burn use at 6000 to 7000 rpm.

NORTON

SAINT GOBAIN

QUANTUM

++++ INNOVATION



NEW CURVED FLAP DISCS FOR ANGLE GRINDERS

The unique shape of the abrasive flaps work at 90 degree angle to the work piece when grinding with disc periphery. It's the ultimate solution for grinding curves, corners and difficult to access areas.

NORTON QUANTUM CURVED PERFORMANCE

- Awkward grinding jobs are a thing of the past thanks to new Norton flap discs which feature an angled edge.
- Sharp zirconia grain cuts fast through metal, making discs not only easy to use, but also practical, durable and hard wearing.
- Each flap is molded to an upward pointing curve designed to easily access to hard to reach contours, corners and T-joints. Achieve excellent results even at low pressure due to the ability of the disc to adapt to the geometry of the workpiece.



METAL
INOX



DIM DxB (mm)	GRIT	PK QTY	ART NO.	PRICE
125 x 22	40	6	69957365404	£000.00
	60	6	69957365405	£000.00
	80	6	69957365406	£000.00
	120	6	69957365407	£000.00



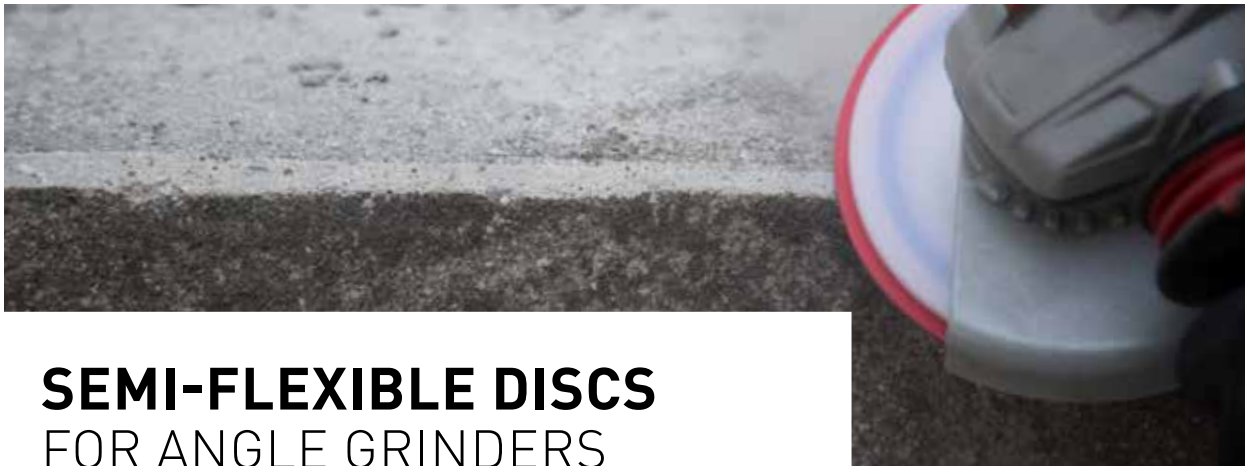

SEMI-FLEXIBLE DISCS FOR ANGLE GRINDERS

Semi-flexible discs are made by coating heavy duty fibre with multiple layers of a special resin bonded abrasive. They are commonly used to clean stone, the hulls of ships & boats, to remove rust from large surfaces and coatings and removing glue or mastic.

CP FLEX **++++**

- Semi flexible black silicon carbide discs for use on marble, granite, concrete, fibreglass & cast irons
- Ideal for use in construction markets for aggressive grinding, leveling and cleaning of surface perfections



	SIZE (mm)	GRIT	PK QTY	ART NO.	PRICE
	 125 x 22	16	25	66261083476	£000.00
		24	25	7660719292	£000.00
		36	25	7660719293	£000.00
		60	25	7660719294	£000.00
		80	25	7660719295	£000.00
	 180 x 22	16	25	66261083479	£000.00
		24	25	7660719296	£000.00
		36	25	7660719297	£000.00
		60	25	7660719298	£000.00
		80	25	7660719299	£000.00

NYLON BACK-UP PADS

- For universal use
- Conforms to ISO 15636

SIZE (mm)	THREAD	DENSITY	MAX. RPM	PK QTY	ART NO.	PRICE
125	M14	Hard	12200	5	69957382829	£000.00
180	M14	Hard	8500	5	69957382830	£000.00

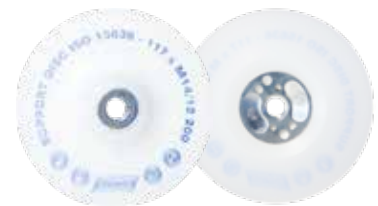







RAPID STRIP DEPRESSED CENTRE DISCS FOR ANGLE GRINDERS

Non-woven discs have three components: strong synthetic fibre mesh, quality abrasive, and a smear-resistant adhesive. Rapid Strip discs have an open web construction for aggressive cutting action while maintaining a cool, non-loading surface. The thick, strong synthetic fibers and extra coarse silicon carbide grain make light work of removing rust, weld splatter, scale and other surface contaminants. Use before and after welding for preparing and cleaning the surface.

BLAZE RAPID STRIP **+++++** DPC TYPE 27 & TYPE 29 CONICAL

- Best choice for removal of surface rust & residue, corrosion, light weld splatter, dirt, mill scale & other similar surface contaminants
- Blaze lasts up to twice as long as other ceramic discs thanks to the Norton SG grain
- Leaves a thoroughly cleaned surface that ensures excellent adhesion for subsequent processes such as coating, painting and soldering
- Extremely versatile; stiff enough to withstand aggressive use, soft enough to prevent gouging and rework. Apply pressure to strip or remove coatings; use lighter pressure to finish like a surface finishing disc



SHAPE	DIAxH (mm)	CAP CODE	PK QTY	MAX RPM	ART NO.	PRICE
	115x22	R9101	10	12000	66623303783	£000.00
	125x22	R9101	10	11000	66623303916	£000.00
	178x22	R9101	10	8000	66623303920	£000.00
	125x22	R9101	10	12000	66261118630	£000.00

RAPID STRIP **+++** DPC TYPE 27

- A general purpose disc for removing coatings on a variety of materials
- Nylon fibers, flexible resin technology and extra coarse abrasive grain for aggressive cut and long life
- Effective cleaning, ensuring excellent adhesion in subsequent processes such as coating, painting and soldering
- Will not load on sticky coatings, adhesives, and soft metals, or snag and shed like a fibre disc



	DIAxH (mm)	CAP CODE	PK QTY	MAX RPM	ART NO.	PRICE
STRIPPA R4104 S	115x22	R4104	5	11000	63642585732	£000.00
	125x22	R4104	5	8500	63642585749	£000.00
RAPID STRIP R4101 H	115x22	R4101	10	12000	66261009649	£000.00
	125x22	R4101	10	12000	66261030655	£000.00

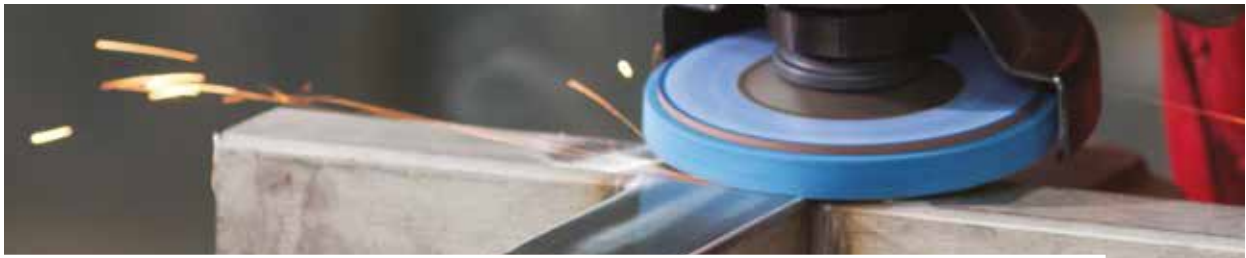

RAPID BLEND DEPRESSED CENTRE DISCS FOR ANGLE GRINDERS

Non-woven discs have three components: strong synthetic fibre mesh, quality abrasive and a smear-resistant adhesive. Rapid Blend discs have a unitized construction with varying weave, from open to tighter, for deburring to finishing applications. Can be used in sequence with fibre and flap discs to blend and impart a good finish in one or two operations.

BLAZE RAPID BLEND **++++**

DPC TYPE 27 (OPEN)

- Blaze ceramic grain for Increased cutting power and life, with ability to remove process steps
- Versatile thin web product with aggressive cutting on small blending applications
- Cuts faster than standard Rapid Blend products, with minimal effect on finish





SHAPE	DIAxTxH (mm)	CAP CODE	GRADE	PK QTY	MAX RPM	ART NO.	PRICE
	125x6x22	U9101	EXTRA COARSE	10	12000	77696067121	£000.00

VORTEX RAPID BLEND **++++**

DPC TYPE 27 & TYPE 29 CONICAL

- For light weld bead and weld splatter removal, heavy deburring and finishing applications
- 2 in 1 action: can cut like an 80 grit flap disc & finishes similar to a Rapid Blend (NEX 2SF) disc
- High-performance engineered grain provides aggressive, fast stock removal, reduced cycle times and increased part quality
- Twice the wheel life of conventional unified wheels, with minimal shedding
- Can be used in place of, or in sequence with, fibre and flap discs for improved part quality wide range of sizes and specs for various applications. Undersized backing plate gives longer usable diameter









SHAPE	DIM DIAxTxH (mm)	CAP CODE	GRADE	PK QTY	MAX RPM	ART NO.	PRICE
	115x12x22	U2305	VORTEX 5AM	10	12000	66254429268	£000.00
	125x12x22	U2305	VORTEX 5AM	10	12000	66254496323	£000.00
	115x12x22	U2305	VORTEX 3AM	10	7500	66623392701	£000.00
	125x12x22	U2305	VORTEX 3AM	10	7500	66623392718	£000.00
	125x6x22	U2305	VORTEX 5AM	10	12000	77696067103	£000.00
	125x6x22	U2305	VORTEX 3AM	10	12000	77696067110	£000.00
	125x12x22	U2305	VORTEX 5AM	10	12000	63642531710	£000.00
	125x12x22	U2305	VORTEX 3AM	10	7500	63642531717	£000.00

RAPID BLEND **+++**

NEX DPC TYPE 27 & TYPE 29 CONICAL

- A unitized construction with varying weave from open structure for deburring to tighter for finishing
- Fine silicon carbide & flexible density unitised construction for a smooth, controlled blending/finishing application
- Cuts more freely and with less heat than competitor products
- Fast finish achieved with a wide range of products to suit a variety of finish requirements
- Undersized backing plate gives longer usable diameter

SHAPE	DIAxTxB (mm)	CAP CODE	GRADE	PK QTY	MAX RPM	ART NO.	PRICE
		U4401	NEX2SF	10	12000	66261020546	£000.00
		U4401	NEX3SF	10	12000	66254461726	£000.00
		U2401	NEX2AF	10	12000	66261020547	£000.00
		U2301	NEX2AM	10	12000	66261020548	£000.00
		F2303	HSMA	10	12000	66261020549	£000.00
		U4401	NEX2SF	10	12000	66254496320	£000.00
		U4401	NEX3SF	10	12000	77696067125	£000.00
		U4401	NEX2SF	10	12000	77696067118	£000.00
		U4401	NEX3SF	10	12000	77696067119	£000.00
		U4401	NEX2SF	10	12000	63642531722	£000.00
		U4401	NEX3SF	10	12000	63642531723	£000.00

HSMA = High Strength Disc



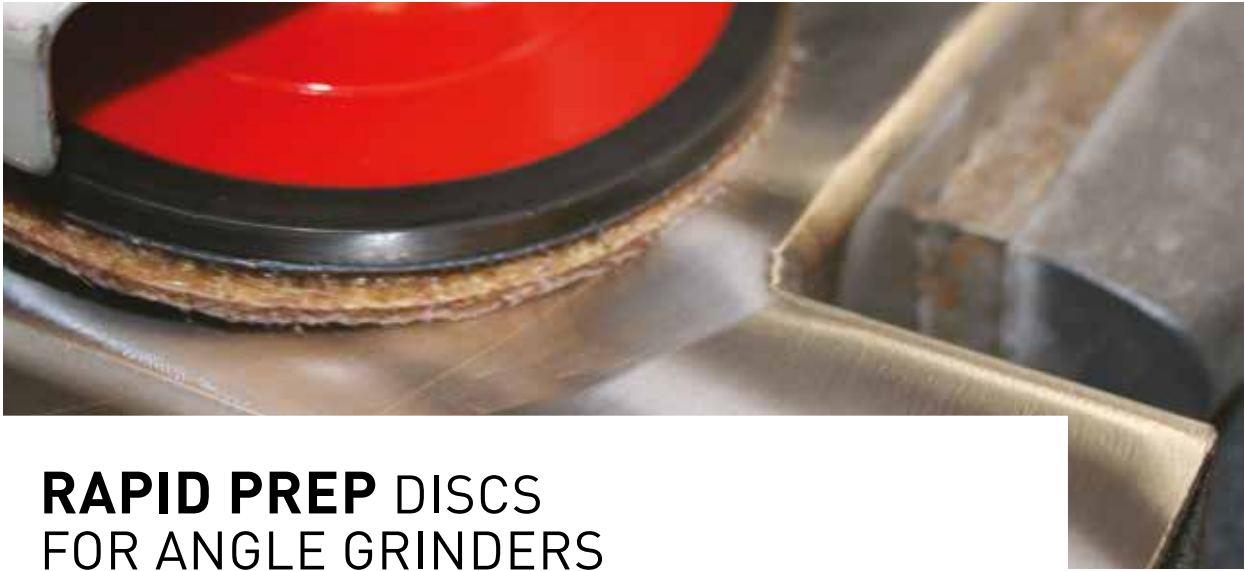

RAPID PREP DISCS FOR ANGLE GRINDERS

Non-woven discs have three components: strong synthetic fibre mesh, quality abrasives, and a smear-resistant adhesive. Rapid Prep discs have an open weave that excels in surface preparation and cleaning applications, thanks to a coating system that reduces smearing and resists loading. Each disc combines the cutting speed of a coarse grit with the finish of a fine and so provides the lowest total cost of consumable tooling per workpiece. The thick layer of grain throughout the product extends the life of the disc.

VORTEX RAPID PREP **++++**

SCM SELF-GRIP WITH REMOVABLE 22mm CENTRE HOLE

- Vortex grain technology combines the cutting speed of coarse grits with the finish of fine grits
- Durable product for blending, finishing, cleaning, and light deburring
- Most consistent cutting and finishing surface conditioning products on the market
- Clean Bond technology - smear free, does not load on aluminium or soft metals
- Achieve a burr-free, paintable finish in fewer steps without damaging the base material



	DIA (mm)	CAP CODE	GRADE	PK QTY	ART NO.	PRICE
	115	S2103	Extra coarse	25	66623378971	£000.00
		S2203	Coarse	25	66623378974	£000.00
		S2303	Medium	25	66623378977	£000.00
		S2403	Fine	25	66623333607	£000.00
		S2503	Very fine	25	66623378980	£000.00
	125	S2103	Extra coarse	25	66623378972	£000.00
		S2203	Coarse	25	66623378975	£000.00
		S2303	Medium	25	66623378978	£000.00
		S2403	Fine	25	66623333609	£000.00
		S2503	Very fine	25	66623378981	£000.00
	178	S2103	Extra coarse	25	66623378973	£000.00
		S2203	Coarse	25	66623378976	£000.00
		S2303	Medium	25	66623378979	£000.00
		S2403	Fine	25	66623334955*	£000.00
		S2503	Very fine	25	66623334969*	£000.00

* Made-to-order

VORTEX RAPID PREP

SCM FLAP DISCS

- Layers of Surface Conditioning Material (SCM) in a variety of grades for quick blending and finishing
- Longer life and durability with smear free cut & finish with one disc
- Three dimensional non-woven abrasive fabric layers containing high performance Vortex grain with Clean Bond™ technology
- Ideal for cleaning, light deburring and processing TIG welded seams on stainless steel

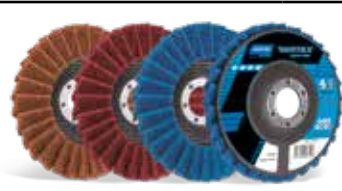
BLENDING	DIM DIAxTxH (mm)	CAP CODE	GRADE	PK QTY	MAX RPM	ART NO.	PRICE
	115x22	S2203	Coarse	10	12200	66261130726	£000.00
		S2303	Medium	10	12200	66261130773	£000.00
		S2403	Fine	10	12200	66261130776	£000.00
		S2503	Very fine	10	12200	66261130777	£000.00
	125x22	S2203	Coarse	10	12200	66261130779	£000.00
		S2303	Medium	10	12200	66261130780	£000.00
		S2403	Fine	10	12200	66261130781	£000.00
		S2503	Very fine	10	12200	66261130782	£000.00

RAPID PREP

SCM (A0) SELF-GRIP WITH REMOVABLE 22mm CENTRE HOLE

- Achieve a burr-free, ready to paint finish in fewer steps without damaging the base material
- General purpose product for blending, finishing, cleaning, and light deburring
- Use with self-grip back up pads with locating centre pin

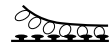

	DIA (mm)	CAP CODE	GRADE	PK QTY	ART NO.	PRICE
	115	S2108	Extra coarse	25	66623378983	£000.00
		S2208	Coarse	25	66623378984	£000.00
		S2308	Medium	25	66623378987	£000.00
		S2408	Fine	25	66623378990	£000.00
		S2508	Very fine	25	66623379028	£000.00
	125	S2108	Extra coarse	25	66623378982	£000.00
		S2208	Coarse	25	66623378985	£000.00
		S2308	Medium	25	66623378988	£000.00
		S2408	Fine	25	66623378991	£000.00
		S2508	Very fine	25	66623379029	£000.00

RAPID PREP SURFACE BLENDING DISCS FOR ANGLE GRINDER

SURFACE BLENDING DISCS

FIBRE BACKED

- Fibre backing provides greater durability and life on demanding applications including edge work



DIA (mm)	CAP CODE	GRADE	TYPE	PK QTY	ART NO.	PRICE
115	S2211	Coarse FB*	DSB	20	63642557510	£000.00
125	S2211	Coarse FB*	DSB	20	63642557721	£000.00
150	S2211	Coarse FB*	DSB	10	63642557727	£000.00

FB* = Fibre backed and with 22mm hole (for a stiffer, higher performing disc)

BACK-UP PADS (SELF-GRIP) WITH LOCATING CENTRE PIN

- Easy location of disc onto centre pin reduces vibration

DIA (mm)	DENSITY	ATTACHMENT	PK QTY	ART NO.	PRICE
115	Medium	M14	1	77696076935	£000.00
125	Medium	M14	1	77696076941	£000.00
178	Medium	M14	1	63642575296	£000.00

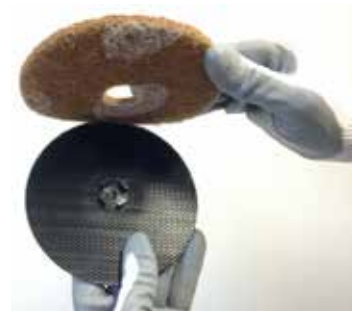

BACK-UP PADS (SELF-GRIP)

DIA (mm)	DENSITY	ATTACHMENT	PK QTY	ART NO.	PRICE
115	Medium	M14	1	69957382846	£000.00
	Medium	5/8	1	63642595937	£000.00
125	Medium	M14	1	69957382841	£000.00
	Medium	5/8	1	63642595938	£000.00
150	Medium	M14	1	69957382843	£000.00
	Medium	5/8	1	63642595939	£000.00
178	Medium	M14	1	69957382844	£000.00
	Medium	5/8	1	63642595940	£000.00





POLISHING DISCS FOR ANGLE GRINDERS

Final scratch removal and imparting a high quality shine are often the last stages in a fabrication process and polishing is easy with Norton BearTex and Rapid Polish discs. Whether you're working on aluminium or stainless steel, Norton has a solution for you.

BEARTEX FLAP DISC

- Beartex fleece discs with open mesh construction
- Two types available, plain & interleaved
- Conforms easily to surface contours and shapes
- For use on a number of metals



DIAXB (mm)	CAP CODE	GRADE	TYPE	PK QTY	MAX RPM	ART NO.	PRICE
115x22	F2504	Very fine A	XFLD (Plain)	10	4900	66254481898	£000.00
	F2504	Very fine A with P120	XIFD (Mixed)	10	4900	66623311000	£000.00

Optimum performance when run at slower speeds on a variable speed power tool.

RAPID POLISH

- Type 29 felt wool polishing pad
- Use with or without polishing compound
- Smooth, scratch free result
- For a professional, mirror shine



DIAXB (mm)	CAP CODE	GRADE	TYPE	PK QTY	MAX RPM	ART NO.	PRICE
115x22	F0005	Felt	XFLD (Plain)	10	8500	66254481899	£000.00
125x22	F0005	Felt	XFLD (Plain)	10	7700	63642573692	£000.00

Optimum performance when run at slower speeds on a variable speed power tool.

INDUSTRIAL POLISHING COMPOUND BLOCKS

	COLOUR	WxLxH (mm)	FINISH	GUIDE	PK QTY	ART NO.	PRICE
	Brown	55x160x38	Pre-polishing	Cleaning very dirty material (alu & non ferrous)	1	7660739107	£000.00
	Green	55x160x38	Gloss	Aluminium & stainless steel	1	7660739108	£000.00
	White	55x160x38	Super high gloss	Polishing stainless steel, alu & non-ferrous	1	7660739109	£000.00
	Blue	55x160x38	General high gloss	All metals & hard plastics	1	7660739112	£000.00

NOTES

Blank lined area for notes.



NORTON

SAINT-GOBAIN®

COATED
ABRASIVES

DISCS FOR MINI ANGLE GRINDERS

Speedlok discs	72	Rapid Blend Speedlok Discs	82
Mini Flap Discs	77	Rapid Prep Speedlok Discs	84
Non-Woven Speedlok Discs	80	Speedlok Buffing & Polishing Discs	86
Rapid Strip Speedlok Discs	81		



SPEEDLOK DISCS FOR MINI ANGLE GRINDERS

The tool-free fastening system enables quick disc changes to maximize productivity and minimise downtime. Ideal for light to medium pressure grinding, blending & finishing on small or difficult to access areas including tool and mold construction, automotive, aeronautical & aerospace industry and equipment and pressure vessel construction. The SpeedLok fastener makes it quick & easy to change. Disc locks securely to back-up pad, no slipping or release caused by heat. The two button attachment systems (TR or TS) ensures the disc is properly centered and vibration free. These discs optimize stock removal, surface finish, thermal load of the workpiece and tool wear. SpeedLok discs achieve their best performance at a recommended speed of 15-35m/s.

PRODUCT SELECTION GUIDE

Highly recommended ●
Recommended ○

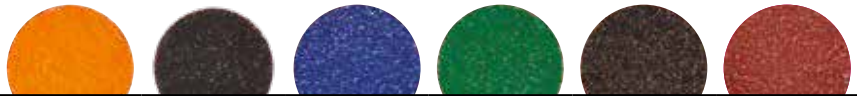

MATERIALS	BLAZE R980P	NEW RED HEAT R983	X-TREME R884P	X-TREME + R801	X-TREME S R422	BDX ARY/ARX19
	+++++	+++++	++++	++++	++++	+++
Stainless steel, inox	●	●		○		
Titanium, inconel & super alloys	●	●		○		
Carbon, construction & mild steel	●	●	●	●		○
Cast iron	○	○	●	●		○
Non-ferrous metal (brass/aluminium)			○			○
Hard wood			●		●	○
Soft wood					○	○
Composite materials					●	○
Stone, concrete					●	○
Glass, plastic					●	○

QUICK CHANGE DISC ATTACHMENTS & TIPS



TS ATTACHMENT
[Type 2 – SL2]
A turn-on/turn-off style fastener



TR ATTACHMENT
[Type 3 – SL3]
Twist on & twist off in 2½ turns



TIP Avoid gouging on contours by using a smaller size holder than the diameter of the discs, such as 38mm holder for 50mm.



MEDIUM



HARD

TIP Select a hard back-up pad for more aggressive applications.

PRODUCT COMPARISON CHART

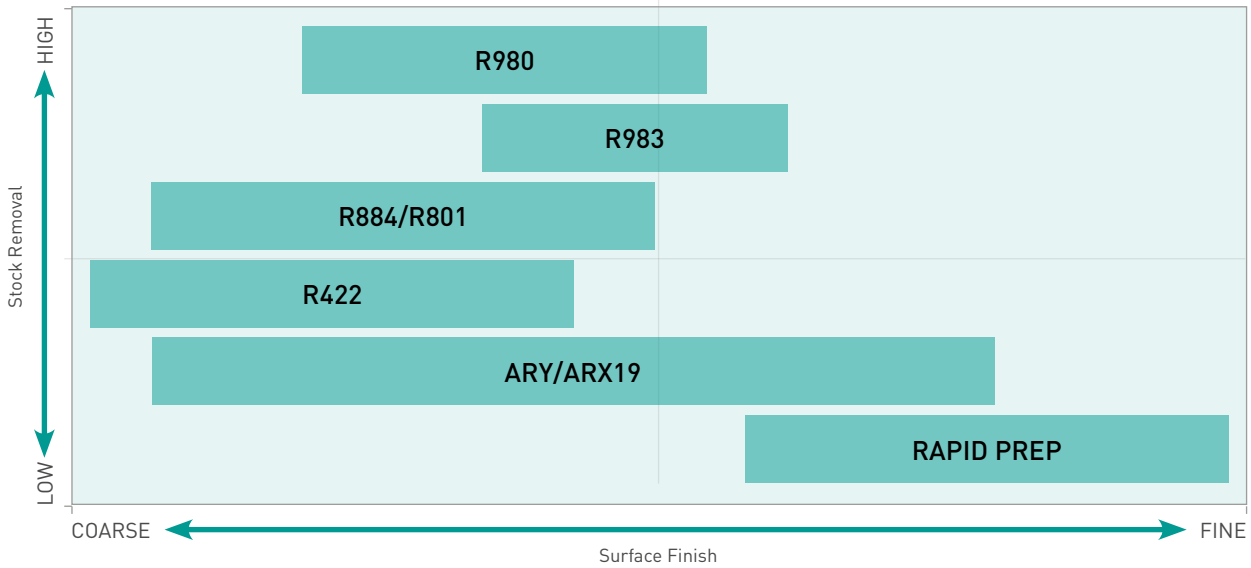

BLAZE R980P **+++++**

- The best choice for part cut & finish on stainless steel, inconels, chromium cobalt, titanium and extremely hard materials
- Provides the coolest cut and significantly faster cut rates
- Aggressive disc removes all defects quickly
- For the greatest durability, longest life, and edge-fray resistance on tough applications and stainless steel



SIZE (mm)	GRIT	MAX. RPM	PK QTY	TR ATTACHMENT		TS ATTACHMENT	
				Part No.	Price	Part No.	Price
25	36	11500 - 26800	100	66261094895	£000.00	-	-
	50	11500 - 26800	100	66254402096	£000.00	-	-
	60	11500 - 26800	100	66261038811	£000.00	-	-
38	36	7600 - 17600	50	63642597033	£000.00	69957390693	£000.00
	50	7600 - 17600	50	63642597034	£000.00	69957390694	£000.00
	60	7600 - 17600	50	63642597037	£000.00	69957390695	£000.00
	80	7600 - 17600	50	63642597038	£000.00	69957390696	£000.00
50	36	5700 - 13400	50	63642597039	£000.00	69957390698	£000.00
	50	5700 - 13400	50	63642597045	£000.00	69957390699	£000.00
	60	5700 - 13400	50	63642597050	£000.00	69957390700	£000.00
	80	5700 - 13400	50	63642597052	£000.00	69957390701	£000.00
	120	5700 - 13400	50	66261136868	£000.00	66261136986	£000.00
75	36	3800 - 8900	50	63642597053	£000.00	69957390702	£000.00
	50	3800 - 8900	50	63642597057	£000.00	69957390703	£000.00
	60	3800 - 8900	50	63642597060	£000.00	69957390704	£000.00
	80	3800 - 8900	50	63642597062	£000.00	69957390705	£000.00
	120	3800 - 8900	50	66261136980	£000.00	-	-



Grinding on stainless generates a considerable amount of heat; always use a Norton Blaze disc with a supersize layer to reduce heat build up and improve cut quality. Typically, a coarse grit disc is used when grinding MIG welds and a finer grit disc is used when grinding TIG welds.

SPEEDLOK DISCS FOR MINI ANGLE GRINDERS

BLAZE F980 FIBRE **+++++**

- The Best choice for very tough applications
- Heaviest fibre backing for greater stock removal, longer life and edge-fray resistance



METAL INOX



SIZE (mm)	GRIT	MAX. RPM	PK QTY	TR ATTACHMENT	
				Part No.	Price
	50	36	5700 - 13400	25	66261058704 £000.00
	50	50	5700 - 13400	25	66261058705 £000.00
	60	5700 - 13400	25	66261058706 £000.00	
75	36	3800 - 8900	25	66261058708 £000.00	
	50	3800 - 8900	25	66261058709 £000.00	
	60	3800 - 8900	25	66261058711 £000.00	

NEW RED HEAT R983 **+++++**

- High performance ceramic discs, laminate free for extra flexibility when working on curves and contours
- New advanced grain formulation & improved backing for excellent cut rate and longer life
- For use in medium pressure applications



METAL INOX



SIZE (mm)	GRIT	MAX. RPM	PK QTY	TR ATTACHMENT		TS ATTACHMENT	
				Part No.	Price	Part No.	Price
	50	36	5700 - 13400	50	66261151081 £000.00	66261151028	£000.00
	50	50	5700 - 13400	50	66261151082 £000.00	66261151036	£000.00
	60	5700 - 13400	50	66261151083 £000.00	66261151038	£000.00	
	80	5700 - 13400	50	66261148410 £000.00	66261151044	£000.00	
	120	5700 - 13400	50	66261151084 £000.00	66261151046	£000.00	
75	36	3800 - 8900	50	66261151085 £000.00	-	-	
	50	3800 - 8900	50	66261151086 £000.00	-	-	
	60	3800 - 8900	50	66261151087 £000.00	-	-	
	80	3800 - 8900	50	66261151088 £000.00	-	-	
	120	3800 - 8900	50	66261151089 £000.00	-	-	

X-TREME R884P **+++++**

- The better choice for use on hard steels, carbon steel, welds and wood
- Provides aggressive cut and longer life than competitor zirconia alumina discs
- Versatile, self-sharpening zirconia alumina plus grain for high stock removal rate on rough grinding and deburring of steel and stainless steel
- Advanced grain coating results in longer life and faster cut rate



FERR. NON FERROUS, INOX



SIZE (mm)	GRIT	MAX. RPM	PK QTY	TR ATTACHMENT		TS ATTACHMENT	
				Part No.	Price	Part No.	Price
	38	36	7600 - 17600	50	-	63642549604	£000.00
	50	7600 - 17600	50	-	66261138622	£000.00	
	60	7600 - 17600	50	-	63642549607	£000.00	
	80	7600 - 17600	50	-	63642549606	£000.00	
50	36	5700 - 13400	50	63642560882	£000.00	63642549747	£000.00
	50	5700 - 13400	50	69957389455	£000.00	69957360306	£000.00
	60	5700 - 13400	50	63642556396	£000.00	63642549748	£000.00



SIZE (mm)	GRIT	MAX. RPM	PK QTY	TR ATTACHMENT		TS ATTACHMENT	
50	80	5700 - 13400	50	63642560884	£000.00	63642549749	£000.00
	120	5700 - 13400	50	63642560885	£000.00	66261115917	£000.00
75	36	3800 - 8900	50	63642560886	£000.00	63642549605	£000.00
	50	3800 - 8900	50	69957389465	£000.00	69957360307	£000.00
	60	3800 - 8900	50	63642560887	£000.00	63642539858	£000.00
	80	3800 - 8900	50	63642560888	£000.00	69957360313	£000.00
	120	3800 - 8900	50	66261137003	£000.00	66261137005	£000.00

X-TREME+ R801

- For demanding grinding applications, the supersize grinding aid facilitates a cooler cut on stainless steel, titanium and other exotic alloys, improving part quality & finish
- Heavy Y-weight polyester backing provides excellent durability and grain adhesion
- Premium, self-sharpening zirconia alumina plus grain with ensures the disc remains sharper for longer, increasing usage time and driving down overall process cost
- High removal rate when used on stainless steel



SIZE (mm)	GRIT	MAX. RPM	PK QTY	TR ATTACHMENT		TS ATTACHMENT	
50	36	5700 - 13400	50	63642556405	£000.00	63642556399	£000.00
	50	5700 - 13400	50	63642587202	£000.00	63642587194	£000.00
	60	5700 - 13400	50	63642556407	£000.00	63642556403	£000.00
	80	5700 - 13400	50	63642587207	£000.00	63642587203	£000.00
	120	5700 - 13400	50	63642587208	£000.00	63642587204	£000.00
75	36	3800 - 8900	50	63642587245	£000.00	-	-
	50	3800 - 8900	50	63642587246	£000.00	-	-
	60	3800 - 8900	50	63642556411	£000.00	-	-
	80	3800 - 8900	50	63642587247	£000.00	-	-
	120	3800 - 8900	50	63642587248	£000.00	-	-



X-TREME S R422

- A great choice for brass, non-ferrous materials, stone, glass and fibre reinforced plastics
- Ideal solution for grinding titanium and non-ferrous aircraft and engine parts
- Sharp premium silicon carbide abrasive for a good cut rate through the life of the disc
- Good material removal in both low or medium pressure applications



SIZE (mm)	GRIT	MAX. RPM	PK QTY	TR ATTACHMENT	
50	60	5700 - 13400	50	66261137014	£000.00
	80	5700 - 13400	50	66261137025	£000.00
	120	5700 - 13400	50	66261137028	£000.00
75	60	3800 - 8900	50	66261137015	£000.00
	80	3800 - 8900	50	66261137026	£000.00
	120	3800 - 8900	50	66261137029	£000.00



SPEEDLOK DISCS FOR MINI ANGLE GRINDERS



BDX ARY19

- For hard to grind materials that require an economical option
- Aggressive cut and longer life than other aluminum oxide discs
- Good cut rate and improved life on moderately-demanding applications
- Resistant to edge wear and fraying



FERR. NON FERR.
WOOD



SIZE (mm)	GRIT	MAX. RPM	PK QTY	TR ATTACHMENT 		TS ATTACHMENT 	
				Part No.	Price	Part No.	Price
38	60	7600 - 17600	50	63642586628	£000.00	63642586596	£000.00
	80	7600 - 17600	50	63642586629	£000.00	63642586607	£000.00
	120	7600 - 17600	50	63642586631	£000.00	63642586608	£000.00
	180	7600 - 17600	50	63642586633	£000.00	63642586609	£000.00
	320	7600 - 17600	50	66261137058	£000.00	63642586617	£000.00
50	36	5700 - 13400	50	63642586683	£000.00	63642586651	£000.00
	60	5700 - 13400	50	69957389332	£000.00	63642586656	£000.00
	80	5700 - 13400	50	63642586687	£000.00	63642586660	£000.00
	120	5700 - 13400	50	63642586689	£000.00	63642586671	£000.00
	180	5700 - 13400	50	63642586691	£000.00	63642586675	£000.00
	320	5700 - 13400	50	63642586695	£000.00	63642586681	£000.00
75	60	3800 - 8900	50	63642586731	£000.00	63642586699	£000.00
	80	3800 - 8900	50	63642586733	£000.00	63642586705	£000.00
	120	3800 - 8900	50	63642586735	£000.00	63642586708	£000.00
	180	3800 - 8900	50	63642586738	£000.00	63642586712	£000.00
	320	3800 - 8900	50	66261137060	£000.00	63642586718	£000.00



Our most versatile SpeedLok disc. Traditional aluminium oxide discs are a good starting specification for general purpose grinding.

MADE-TO-ORDER PRODUCT AVAILABILITY

CAP CODE	GRAIN / GRIT	24	36	40	50	60	80	100	120	150	180	240	320
Blaze R980P	Ceramic with supersize	•	•	•	•	•	•	•	•				
Xtreme R884P	Zirconia	•	•		•	•	•		•				
Xtreme + R801	Zirconia with supersize		•	•	•	•	•	•	•				
Xtreme S R422	Silicon carbide		•	•	•	•	•	•	•	•			
BDX ARY19	Aluminium oxide	•	•	•	•	•	•	•	•	•	•	•	•

• Available

MINIMUM ORDER QUANTITY

SIZE (mm)	MINIMUM ORDER QUANTITY	SIZE (mm)	MINIMUM ORDER QUANTITY
25	500 pieces	50	250 pieces
38	500 pieces	75	250 pieces



MINI FLAP DISCS FOR MINI ANGLE GRINDERS

Ideal for weld dressing on small and difficult to access areas as well as general stock removal, deburring, flashing, blending and finishing. Mini flap discs have long life and minimize downtime by increasing productivity.

The SpeedLok fastener makes it quick & easy to change discs by locking securely to the back-up pad, so no slipping or release is caused by heat build-up. The TR button attachment systems ensure the disc is properly centered and vibration free. Best performance is achieved at a recommended speed of 30-40m/s. This optimises stock removal, surface finish, thermal load of the workpiece & tool wear.

PRODUCT SELECTION GUIDE

Highly recommended ●
Recommended ○



	BLAZE +++++	X-TREME ++++	BDX +++
Stainless steel, inox & duplex	●	○	
Inconel, titanium & super alloys	●	○	
Carbon steel, construction steel & mild steel	●	●	○
Cast iron	○	●	○
Non-ferrous metal (brass/aluminium)		●	○
Hard & soft wood		●	○

PRODUCT COMPARISON CHART

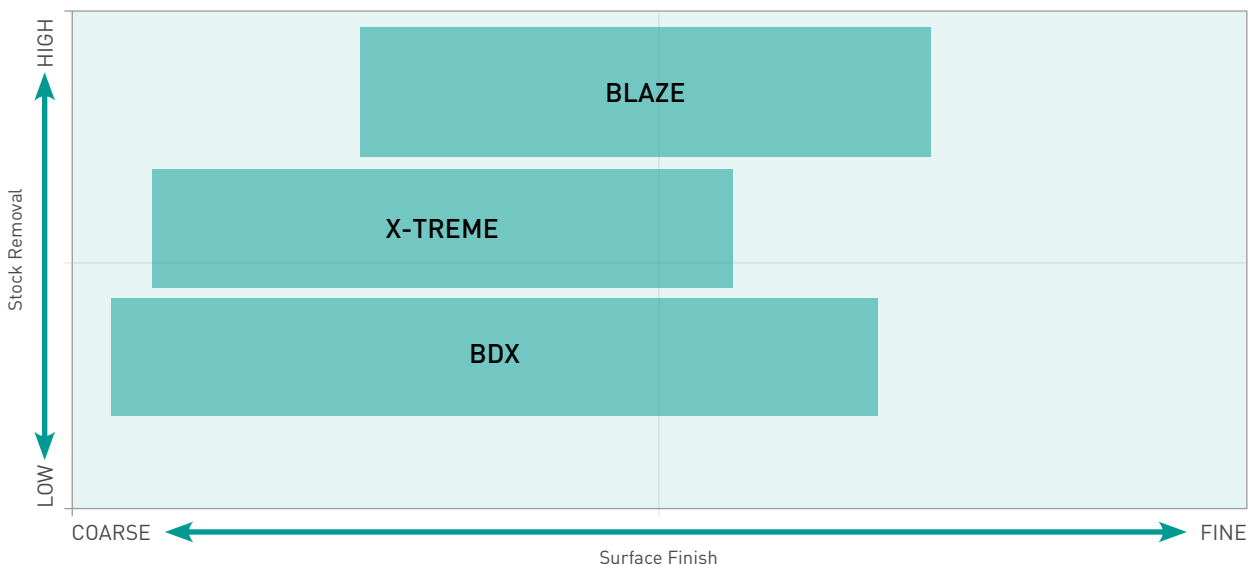

MINI FLAP DISCS FOR MINI ANGLE GRINDERS

BLAZE R980P

- For stainless steel and super alloys
- Provides longer life compared to any mini flap disc when used on stainless, titanium & super alloys
- Extremely aggressive ceramic grain for noticeably faster cut rate
- Supersize layer for a cooler cut and reduced heat generation during use, providing better part quality and no burn marks



METAL
INOX



	SIZE (mm)	GRIT	MAX. RPM	PK QTY	TR ATTACHMENT 	BACK-UP PAD
	50	36	11500 - 15000	10	66261120103	63642556629
		40	11500 - 15000	10	66261120104	
		60	11500 - 15000	10	66261120109	
		80	11500 - 15000	10	66261120110	
	75	36	7500 - 10000	10	66261120111	63642556629
		40	7500 - 10000	10	66261120112	
		60	7500 - 10000	10	66261120116	
		80	7500 - 10000	10	66261120117	



Grinding on stainless generates a considerable amount of heat; always use a Norton Blaze mini-flap disc with supersize layer (cooling aid) to reduce heat generation and improve cut and finish. Typically, a coarse grit disc is used when grinding MIG welds and a finer grit disc is used when grinding TIG welds.



X-TREME R828

- Ideal for carbon steel and welds
- Strong zirconia alumina plus for high stock removal rate on rough grinding and deburring of steel and stainless steel
- Delivers aggressive cut rate and longer life on carbon steel and welds
- Prevents loading on aluminum and other soft materials



FERR. NON
FERROUS, INOX



	SIZE (mm)	GRIT	MAX. RPM	PK QTY	TR ATTACHMENT 	BACK-UP PAD
	50	40	11500 - 15000	10	66261180892	63642556629
		60	11500 - 15000	10	66261180893	
		80	11500 - 15000	10	66261180894	
	75	40	7500 - 10000	10	63642527476	63642556629
		60	7502 - 10000	10	66261180904	
		80	7503 - 10000	10	63642527482	



FLEXI FLAP

Also available in mini flexi-flap disc, which adapts to contours and corners. The flexible cloth and disc construction is ideal for an improved finish and operator comfort during use.

SIZE (mm)	GRIT	MAX. RPM	PK QTY	TR ATTACHMENT 	BACK-UP PAD
50	40	11500 - 15000	10	66261180889	63642556629
	60	11500 - 15000	10	66261180890	
	80	11500 - 15000	10	66261180891	

BDX R766

- A good choice for aluminum, carbon steel & difficult-to-grind materials that require an economical option
- For longer life and faster cut rate on moderately demanding applications
- For aggressive cut and longer life than competitor aluminum oxide discs



FERR. NON
FERROUS



	SIZE (mm)	GRIT	MAX. RPM	PK QTY	TR ATTACHMENT 		BACK-UP PAD
	50	40	11500 - 15000	10	66261119970	£000.00	63642556629
		60	11500 - 15000	10	66261119973	£000.00	
		80	11500 - 15000	10	66261119975	£000.00	
		120	11500 - 15000	10	66261119976	£000.00	
	75	40	7500 - 10000	10	66261119979	£000.00	63642556629
		60	7500 - 10000	10	66261119980	£000.00	
		80	7500 - 10000	10	66261119981	£000.00	
		120	7500 - 10000	10	66261119982	£000.00	

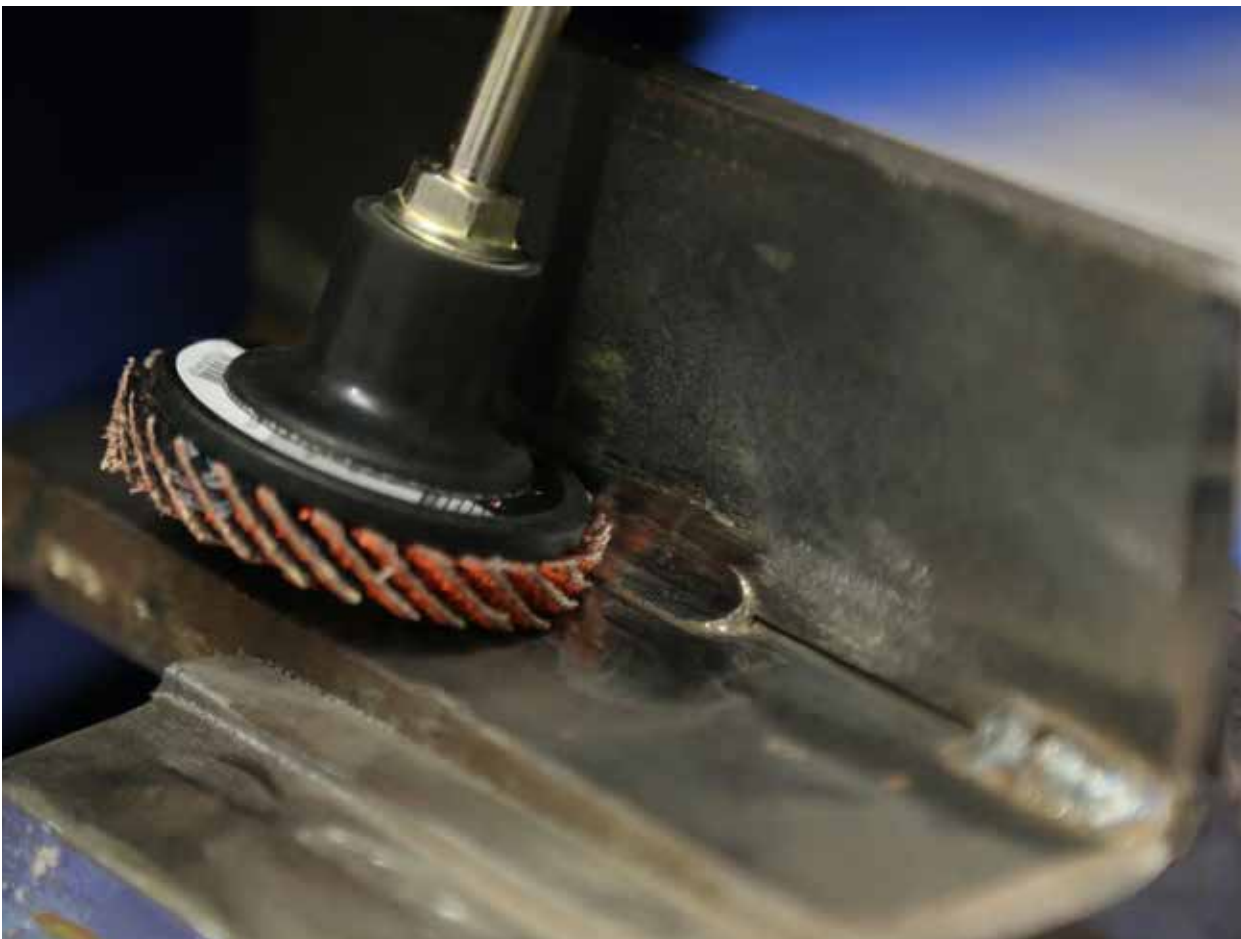



NON-WOVEN SPEEDLOK DISCS FOR MINI ANGLE GRINDERS

Norton non-woven SpeedLok quick-change discs are a combination of strong synthetic mesh and quality abrasives, bonded together by a smear-resistant adhesive. The open construction of the non-woven material enables aggressive cutting action and improved surface finish while maintaining its non-loading properties.

PRODUCT SELECTION GUIDE

Highly recommended ●
Recommended ◐

	RAPID STRIP	VORTEX RAPID BLEND	VORTEX RAPID PREP	RAPID PREP	RAPID BLEND NEX
	+++++	++++	++++	+++	+++
Scale	●				
Stock removal	●	◐			
Heavy deburring	◐	●			
Light deburring		●	◐		
Light finishing			●	◐	●
Blending			●	◐	◐
Finishing			◐	●	●

← MOST AGGRESSIVE
LEAST CONFORMABLE

→ LEAST AGGRESSIVE
MOST CONFORMABLE





RAPID STRIP SPEEDLOK DISCS FOR MINI ANGLE GRINDERS

An open web construction for an aggressive cut without loading. The thick, strong synthetic fibers and extra coarse silicon carbide grain make light work of removing rust, weld splatter & scale. Use before and after welding for preparing and cleaning the surface.

BLAZE RAPID STRIP **++++**

- Ideal for removing coatings on a variety of surfaces
- With ceramic alumina grain, disc lasts 2x longer than competitor
- Cleans surface thoroughly for excellent adhesion of coatings, painting and soldering
- Withstands aggressive use whilst preventing gouging





DIA (mm)	CAP CODE	GRADE	MAX. RPM	PK QTY	TR ATTACHMENT 	TR+ ATTACHMENT 
50	R9101	X Coarse SG	20000	25	66623303912 £000.00	-
75	R9101	X Coarse SG	15000	25	66261096557 £000.00	-
100	R9101	X Coarse SG	8000	5	-	66261137035 £000.00

Use with TR+ Holder

RAPID STRIP **+++**

- General purpose, for removing coatings
- Cleans surface thoroughly for excellent adhesion of coatings, painting and soldering
- Extra-coarse abrasive grain for aggressive performance
- Anti-loading even on sticky coatings, adhesives, and soft metals



DIA (mm)	CAP CODE	GRADE	MAX. RPM	PK QTY	TR RAPID STRIP 	TR STRIPPA 
50	R4101	X Coarse S	20000	10	63642588173 £000.00	-
	R4104	X Coarse S	20000	10	-	63642556605 £000.00
75	R4101	X Coarse S	15000	10	63642588175 £000.00	-
	R4104	X Coarse S	15000	10	-	63642556624 £000.00

Use with TR+ Holder

TR+ RAPID STRIP 

100	R4101	X Coarse SG	8000	5	63642585751 £000.00
-----	-------	-------------	------	---	---------------------



RAPID BLEND SPEEDLOK DISCS FOR MINI ANGLE GRINDERS

From material removal to final smear free finish with just one disc! With their uniquely compact design, Rapid Blend discs are ideal for quick deburring, edge breaking, blending, cleaning and polishing. Can be used in sequence with fibre discs and flap discs when removing surface defects, conditioning grindlines and general light stock removal.

VORTEX RAPID BLEND OPEN STRUCTURE

- Soft and open density of nylon fibre impregnated with patented grain technology and advanced resin system prevents loading, even on aluminium
- Special resin chemistry resists shedding when used on sharp edges, making it ideal for deburring, no smearing
- Longer life than other surface blending discs (up to 8x) means fewer disc changes for less down time and increased productivity



DIAxT (mm)	CAP CODE	GRADE	MAX. RPM	PK QTY	TR ATTACHMENT 
25x6	U2311	Medium	35100	100	66254497806 £000.00
38x6	U2311	Medium	30100	80	66254497807 £000.00
50x6	U2311	Medium	22000	25	66254497067 £000.00
75x6	U2311	Medium	18000	25	66254497068 £000.00

VORTEX RAPID BLEND CLOSED STRUCTURE

- Closely closed structure of grain and bond provides fast stock removal, reduced cycle time and excellent part quality
- Thick nylon web holds the grain in place to provide the most consistent performance for the whole life of the disc
- Special curing process ensures the disc will not break down in heavy deburring applications
- Discs maintain form holding for use on all surfaces, shapes and contours



	DIAxT (mm)	CAP CODE	GRADE	MAX. RPM	PK QTY	TR ATTACHMENT	
	50x6	U2305	3AM	22000	60	66254428237	£000.00
		U2305	5AM	22000	60	66254413660	£000.00
		U2305	7AM	22000	60	66254433510	£000.00
	75x3	U2305	5AM	18000	40	66261093556	£000.00
		U2305	7AM	18000	40	66261090909	£000.00
	75x6	U2305	3AM	18000	40	66254428238	£000.00
		U2305	5AM	18000	40	66254413661	£000.00
		U2305	7AM	18000	40	66254406395	£000.00

RAPID BLEND NEX

- Strong mesh, abrasive and smear resistant adhesive provides aggressive cut and good surface finish without loading
- Abrasive is distributed through the entire disc (top, bottom and sides) so all three faces can be used
- Versatile, comfortable and easy to use without risk of change to workpiece geometry.
- Excellent for light deburring of flashing & threads, blending alloys, polishing & finishing. Can be preformed. Holds shape
- Bright finish on stainless steel with improved 2SF and 3SF specification



	DIA (mm)	CAP CODE	GRADE	MAX. RPM	PK QTY	TR ATTACHMENT	
	50	U2301	2 A Medium	22000	10	63642585684	£000.00
		U2301	6 A Medium	22000	10	63642585725	£000.00
		U4401	2 S Fine	22000	10	63642585677	£000.00
		U4401	3 S Fine	22000	10	66254473613	£000.00
		U2401	4 A Fine	22000	10	63642585679	£000.00
		75	U2301	2 A Medium	18000	10	63642585697
	U2301	6 A Medium	18000	10	63642585726	£000.00	
	U4401	2 S Fine	15000	10	63642585691	£000.00	
	U4401	3 S Fine	15000	10	66254473614	£000.00	
	U2401	4 A Fine	15000	10	63642585695	£000.00	





RAPID PREP SPEEDLOK DISCS FOR MINI ANGLE GRINDERS

Non-woven discs have three components: strong synthetic fibre mesh, quality abrasives, and a smear-resistant adhesive. Rapid Prep discs have an open weave that excels in surface preparation and cleaning applications, thanks to a coating system that reduces smearing and resists loading. Each disc combines the cutting speed of a coarse grit with the finish of a fine and so provides the lowest total cost of consumable tooling per workpiece. The thick layer of grain throughout the product extends the life of the disc.

VORTEX RAPID PREP^{SCM}

- For cleaning and conditioning, gain higher material removal, longer life and consistent, smear-free finishes, even on high nickel content alloys
- Proprietary engineered Vortex aluminum oxide abrasive grain and coating method combine maximum cutting speed with the consistent finish of finer grades to reduce process times by 50%+ by combining multiple grit sequences into 1 step
- Up to 4x longer life than competitor products, material removal level is maintained throughout disc life, reducing the need for rework & reducing total consumable cost
- The Clean Bond™ resin system ensures surfaces stay smear-free, even on alloys with high nickel content, aluminium and soft metals, loading is prevented





	DIA (mm)	CAP CODE	GRADE	PK QTY	TR ATTACHMENT 	
	50	S2103	Extra coarse	50	66623378336	£000.00
		S2203	Coarse	50	66623378340	£000.00
		S2303	Medium	50	66623378342	£000.00
		S2403	Fine	50	66623378345	£000.00
		S2503	Very fine	50	66623378347	£000.00
		75	S2103	Extra coarse	25	66623378337
S2203	Coarse		25	66623378341	£000.00	
S2303	Medium		25	66623378343	£000.00	
S2403	Fine		25	66623378346	£000.00	
S2503	Very fine		25	66623378348	£000.00	

Other sizes and grades available MTO

RAPID PREP_{A/O SCM}

- For general purpose cleaning and conditioning, gain high material removal, long life and consistent, smear-free finishes, even on high nickel content alloys
- The layer of grain throughout the product extends life as the grain does not sit on top of fibres
- Flexible backing enables the disc to conform to contours
- The Clean Bond™ resin system ensures surfaces stay smear-free, even on alloys with high nickel content, aluminium and soft metals, loading is prevented



	DIA (mm)	CAP CODE	GRADE	PK QTY	TR ATTACHMENT 	
	50	S2108	Extra coarse	50	66623378355	£000.00
		S2208	Coarse	50	66623378359	£000.00
		S2308	Medium	50	66623378363	£000.00
		S2408	Fine	50	66623378366	£000.00
		S2508	Very fine	50	66623378372	£000.00
	75	S2108	Extra coarse	25	66623378356	£000.00
		S2208	Coarse	25	66623378360	£000.00
		S2308	Medium	25	66623378364	£000.00
		S2408	Fine	25	66623378382	£000.00
		S2508	Very fine	25	66623378373	£000.00



SPEEDLOK BUFFING & POLISHING DISCS FOR MINI ANGLE GRINDERS

Final scratch removal and imparting a high quality shine are often the last stages in a fabrication process and polishing is easy with Norton BearTex buffing discs and Rapid Polish discs. Whether you're working on aluminium or stainless steel, in intricate or hard to reach areas Norton has a solution for you.

HIGH STRENGTH BUFFING DISC

- Tough, yet conformable, resists tearing on burrs and sharp edges
- Follows contours and awkward profiles easily.
- Premium aluminium oxide grain for aggressive blending and cleaning without smearing
- Ideal for rust/oxide or coating removal, pipe ID and OD polishing, casting cleaning, highlighting (antiquing), contaminant removal, removal of handling marks, gasket removal, cleaning and blending of surface imperfections, prepping prior to soldering, removal of filling materials, cleaning angles and odd shapes.
- Will not stretch or shed



DIA (mm)	CAP CODE	GRADE	PK QTY	TR ATTACHMENT 
50	F2303	Medium A	50	63642585924 £000.00
	F2506	Very Fine A	50	08834163987 £000.00
75	F2303	Medium A	50	08834164065 £000.00
	F2506	Very Fine A	50	63642585932 £000.00

RAPID POLISH

- Polishing is the final stage in the process, to achieve a glossy, high shine finish
- Use on all metals including stainless steel & aluminium
- Removes fine scratches
- Impart a high quality mirror shine



DIA (mm)	GRADE	PK QTY	TR ATTACHMENT 
50	Medium A	50	63642587165 £000.00
75	Medium A	50	63642587167 £000.00



TR ATTACHMENT 





TS ATTACHMENT 



TR+ ATTACHMENT 

RUBBER BACK-UP PADS FOR MINI ANGLE GRINDER

6mm SPINDLE

SIZE (mm)	DENSITY	MAX. RPM	PK QTY	TR ATTACHMENT 	TS ATTACHMENT 
25	Medium	38100	1	63642556628 £000.00	7660718963 £000.00
38	Medium	25100	1	63642556629 £000.00	7660707032 £000.00
50	Medium	19000	1	7660717817 £000.00	63642501157 £000.00
	Hard	19000	1	63642586931 £000.00	63642586926 £000.00
75	Medium	12800	1	63642556631 £000.00	7660707384 £000.00
	Hard	12800	1	66254401460 £000.00	63642586932 £000.00

PLASTIC BACK-UP PADS FOR MINI ANGLE GRINDER

TR+ ATTACHMENT (TR+ - SL4)

- Plastic back-up pad with 6mm spindle for 100mm Speedlok TR+ discs

SIZE (mm)	DENSITY	MAX. RPM	PK QTY	TR+ ATTACHMENT 
100	Hard	15000	1	63642586196 £000.00



Medium density suitable for medium/fine applications such as edge rounding or surface grinding.
Hard density suitable for coarse applications and higher stock removal such as chamfering, welded seam or deburring work.

SPEEDLOK BUFFING & POLISHING DISCS FOR MINI ANGLE GRINDERS

BACK-UP PADS FOR ANGLE GRINDERS TR ATTACHMENT (TYPE 3-SL3)

- Back-up pad with M14 thread

SIZE (mm)	DENSITY	MAX. RPM	PK QTY	TR ATTACHMENT	
75	Medium	11200	1	63642587305	£000.00
	Hard	11200	1	63642557133	£000.00



ANGLE GRINDER ADAPTOR

- Adapts the standard quick change back-up pad for use on an angle grinder
- Suitable for use with rubber back-up pads
- Female M14, male thread 1/4 - 20 UNC

TYPE	DENSITY	MAX. RPM	PK QTY	ART NO.	PRICE
M14 Adaptor	Metal	12000	1	63642587997	£000.00



To use a standard rubber back-up pad on an angle grinder, unscrew the 6mm shaft and insert the adaptor M14 - 1/4"

HOW TO USE A MINI DISC ADAPTOR ON AN ANGLE GRINDER



1 Remove the metallic spindle and screw the adaptor to use the rubber back-up directly on the angle grinder.



2 Adapt your 3/8" - 24 or 5/8" - 11 right angle grinder to a Type II or Type III back-up pad.



For hard to reach areas



For curves and corners



For small surface areas



MINI RIGHT ANGLE DIE GRINDER GRINDING TOOLS AND KITS

Norton offers mini tools for grinding and sanding to make life easier in detailed, hard to reach applications. Use with Norton SpeedLok discs for surface preparation and defect removal on curves, contours and tight areas.

MINI RIGHT ANGLE ANGLE GRINDER **+++**

50mm (2") MAX RPM 22,000 (0.45 HP)

- Designed for use with the quick-change back-up pad and SpeedLok and mini flap discs.
- Use with 38mm and 50mm quick change sanding discs and spindle mounted sanding specialties only. The accessories must have a rated speed greater than the speed marked on the tool



EXHAUST DIRECTION	THROTTLE TYPE	HORSEPOWER	AIR CONSUMPTION (L/MIN)	COLLET CHUNK	TOOL WEIGHT	ART NO.	PRICE
Rear	Level	0,45	85	6mm	0,74 kg	66261177765	£000.00



**SPEC
CHECK**

Air tools require regular lubrication throughout the life of the tool. The air motor and bearing use compressed air to power the tool. Because moisture in compressed air will rust the air motor, it must be lubricated daily.

An inline oiling device is recommended.

Before using the machine add 1-2 drops of oil in the machine air inlet.



This is an **UNGUARDED** tool and should **NEVER** be used with cut-off discs or other bonded abrasive grinding wheels. Never use any product that has a MAX RPM rating less than the RPM marked on the tool.

NORTON MINI RIGHT ANGLE DIE GRINDER **STARTER KIT**

COMPATIBLE WITH 50mm (2") DISCS

MAX RPM 22,000 (0.45 HP)

- An assortment of 45 abrasive SpeedLok discs, of the most popular grades for stripping, deburring and surface blending, and the new Norton mini right angle die grinder



KIT CONTENTS	ITEM ART NO.	PK QTY	KIT ART NO.	PRICE
50mm (2") NORTON MINI RIGHT ANGLE DIE GRINDER: MAX RPM 22,000 (0.45 HP)	66261177765	1		
NORTON TOOL BAG: POLYESTER 600D, SIZE:56x31x45cm	-	1		
DIR ZMD 2"x0" R9101 NOR AOXC SL3 OR BZR+	66623303912	10	69957300298	£000.00
SPE ZMD 2" F980 NOR C36 LTB SL3 NA	66261058704	25		
DIB ZMD 2"x0" S2303 NOR VTME SL3B MA VR+	66623378342	10		
BU (ZMD) 50x6 SL3 hard NOR	63642586931	1		

NORTON MINI RIGHT ANGLE DIE GRINDER & SPEEDLOK DISCS **PROFESSIONAL KIT**

COMPATIBLE WITH 50mm (2") DISCS

MAX RPM 22,000 (0.45 HP)

- A complete assortment of our product SpeedLok disc range complete with mini angle grinder
- Includes samples of the most popular abrasive SpeedLok discs for all application stages from cleaning, deburring, blending up to surface preparation



KIT CONTENTS	ITEM ART NO.	PK QTY	KIT ART NO.	PRICE
50mm (2") NORTON MINI RIGHT ANGLE DIE GRINDER: MAX RPM 22,000 (0.45 HP)	66261177765	1		
NORTON TOOL BAG: POLYESTER 600D, SIZE:56x31x45cm	-	1		
DIR ZMD 2"x0" R9101 NOR AOXC SL3 OR BZR+	66623303912	5		
SPE ZMD 2" F980 NOR C36 LTB SL3 NA	66261058704	5		
SPE ZMD 50 R980P NORTON C50 LTYH SL3 X	63642597045	5		
SPE ZMD 50 R980P NORTON C80 LTYH SL3 X	63642597052	5	69957300300	£000.00
FLD FXSP 50 R980 NOR C36 NMINI SL3	66261120103	5		
DIB ZMD 2"x0" S2303 NOR VTME SL3B MA VR+	66623378342	5		
DIB ZMD 2"x0" S2503 NOR VTFV SL3B BL VR+	66623378347	5		
UNW WZMD 2"x1/4"x0" U4401 NOR SIFI2 SL3+	63642585677	5		
BU (ZMD) 38x6 SL3 medium NOR	63642556629	1		
BU (ZMD) 50x6 SL3 hard NOR	63642586931	1		



NORTON

SAINT-GOBAIN®

COATED

DISCS FOR ORBITAL MACHINE

Norton Meshpower Discs
Self-Grip & Beartex Discs

92 Screenback Discs
94 Plain Discs
Beartex Floor Pads

103
104
106



NORTON MESHPOWER DISCS

An alternative to traditional perforated paper discs, Norton MeshPower is a multifunctional abrasive, designed with thousands of holes, created by the unique mesh matrix structure. This hole structure allows dust extraction in any application.

- Mesh backing enables excellent dust extraction, for a cleaner working environment and less clean up time
- No-fil® technology prevents clogging for longer product life
- Can be used wet or dry
- Self-grip backing for a quick and easy disc change
- Can be used on many materials, flat and contoured surfaces, by hand or machine
- No defined hole pattern for fast, easy alignment with the back-up pad
- Easy to identify product type by grain colour

POWERFUL DUST EXTRACTION MEANS A CLEANER ENVIRONMENT

The demand for a cleaner working environment, better quality finish and reduced consumable cost, means sanding solutions have evolved, from paper backed abrasive to a mesh construction with thousands of tiny holes.

Norton MeshPower responds to these demands by offering dust extraction in many operations. The open mesh construction of the backing allows dust particles to flow freely through thousands of tiny holes, creating a virtually dust free sanding environment. Better for your health, better for your application and better for your business!

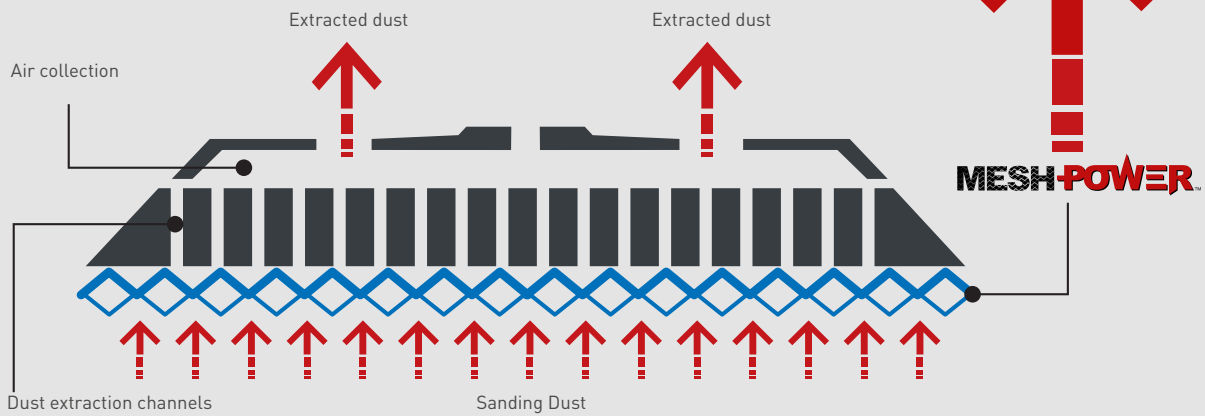

CERAMIC ADVANTAGE

Ceramic grain provides the ultimate material removal, best productivity, longest life and finest finish.

NEW MESHPOWER DISCS CERAMIC **+++++**



SIZE (mm)	GRIT	PK QTY	ART NO.	PRICE
150	80	50	69957325723	£000.00
	120	50	69957325730	£000.00
	180	50	69957325731	£000.00
	240	50	69957325732	£000.00
	320	50	69957325733	£000.00
	400	50	69957325736	£000.00
203	80	50	69957326072	£000.00
	120	50	69957326073	£000.00
	180	50	69957326075	£000.00
	240	50	69957326076	£000.00
	320	50	69957326077	£000.00
	400	50	69957326078	£000.00

NEW MESHPOWER DISCS ALUMINIUM OXIDE **+++++**



SIZE (mm)	GRIT	PK QTY	ART NO.	PRICE
150	80	50	69957326274	£000.00
	120	50	69957326275	£000.00
	180	50	69957326276	£000.00
	240	50	69957326277	£000.00
	320	50	69957326278	£000.00
	400	50	69957326279	£000.00

PAD SAVER

SIZE (mm)	TYPE / GRADE	PK QTY	ART NO.	PRICE
150	Multi-Air	1	69957328425	£000.00
	14+1 holes	1	69957328430	£000.00

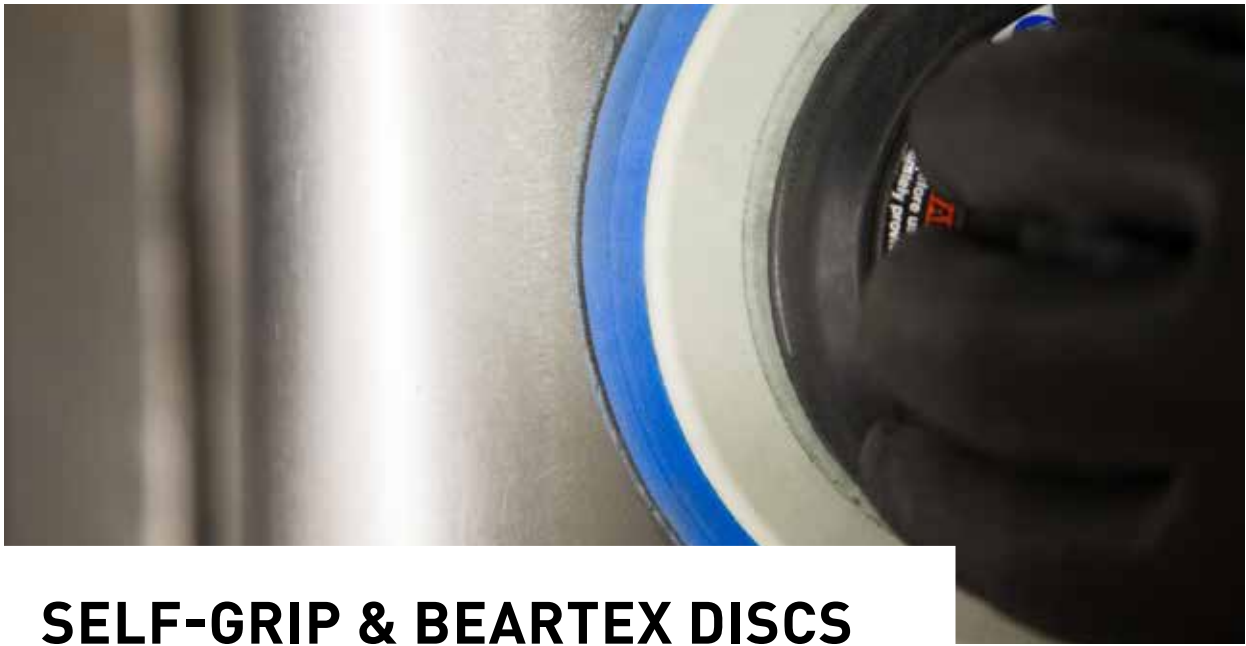

SELF-GRIP & BEARTEX DISCS

Self-Grip discs have a quick release backing that allows fast and easy disc changing, increasing performance by minimising downtime. Made with premium abrasive grains for excellent cutting action providing a very homogenous and high quality finish. Depending on the grit size, Norton self-grip discs are ideal for preparing primed & painted surfaces, stripping primer, varnish & paint, sanding plastic & fibreglass, light weld blending & deburring and sanding bare wood.

PRODUCT SELECTION GUIDE

Highly recommended ●
Recommended ◐
Suitable ○



MATERIALS	APPLICATIONS	NORTON PRO PLUS A975	BLUE FIRE NORZON H835F	NORTON PRO A275	H231	NORTON PRO FILM Q275	H425*	A290
		+++++	+++++	++++	++++	++++	++++	+++
Metal	Coarse sanding		●		◐			○
	Finishing		●		◐			○
Hard wood	Coarse sanding		●	○	◐		◐	
	Finishing	●	◐	◐	●	◐	◐	○
Soft wood	Coarse sanding		◐	◐	●		◐	○
	Finishing	●	◐	◐	◐	◐	◐	○
Filler	Aluminium / metal	◐	●	◐		◐		○
	Polyester	●	◐					○
Varnish / paint / primer	Coarse sanding		◐	●	◐			○
	Finishing	●	◐	◐	○	◐		○
Composites / coatings	Epoxy		●		◐			○
	Acrylic	●		◐				○
	Fibre glass		●		◐			○
Plaster	Coarse sanding			◐		◐	○	●
	Finishing			●	○			◐
Stone & glass	Coarse sanding				○		●	
	Finishing				○		●	

*Available only has MTO

HOLE PATTERNS

Discs are available with different hole patterns for improved dust extraction.

The most popular hole patterns available stock are shown below, other hole patterns available on request, check the MTO offering for more information.



ø76mm
without holes



ø150mm
without holes



ø125mm
with 8 holes ø10mm
on hole circle ø65mm

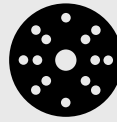

ø150mm
with 15 holes ø9mm
on hole circle ø120mm;
6 holes ø9mm
on hole circle ø80mm
+ 1 centre hole ø17mm

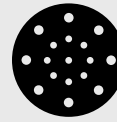

**NEW HOLE
PATTERN AVAILABLE**

ø150mm
with 17 holes
8 holes ø10 mm
on hole circle ø120mm;
8 holes ø8mm
on hole circle ø65mm
+ 1 centre hole ø10mm

NORTON PRO PLUS A975

- Norton SG ceramic grain blended with premium heat-treated aluminium oxide abrasive for higher & faster cut rate with uniform scratch pattern
- Fibre reinforced latex paper is flexible yet tear resistant
- No-fil® treatment reduces clogging during use and extends the life of the disc
- Also available with soft-touch foam backing



	DIAXH (mm)	GRIT	PK QTY	BOX QTY	ART NO.	PRICE
	150	80	100	400	63642523303	£000.00
		120	100	400	63642524766	£000.00
		150	100	400	63642557521	£000.00
		180	100	400	63642591994	£000.00
		240	100	400	63642591990	£000.00
		80	100	400	66254477881	£000.00
	120	100	400	66254477879	£000.00	
	150	100	400	66254477882	£000.00	
	180	100	400	66254477883	£000.00	
	220	100	400	66254477884	£000.00	
	240	100	400	66254477885	£000.00	
	280	100	400	66254477886	£000.00	
	320	100	400	66254477887	£000.00	
	400	100	400	66254477888	£000.00	
	500	100	400	66254476601	£000.00	
	600	100	400	63642532659	£000.00	
	800	100	400	66254479091	£000.00	

See the Norton Automotive Aftermarket catalogue for the extended range of H975 Multi-Air self-grip & Multi-Air Soft Touch discs

SELF-GRIP & BEARTEX DISCS

**NEW HOLE
PATTERN AVAILABLE**

DIAXH (mm)	GRIT	PK QTY	BOX QTY	ART NO.	PRICE
150  17 holes	80	100	400	69957306977	£000.00
	120	100	400	69957306978	£000.00
	150	100	400	69957306979	£000.00
	180	100	400	69957306980	£000.00
	220	100	400	69957306982	£000.00
	240	100	400	69957306984	£000.00
	280	100	400	69957306989	£000.00
	320	100	400	69957306991	£000.00
	400	100	400	69957306992	£000.00
	500	100	400	69957307017	£000.00
	600	100	400	69957307018	£000.00
	800	100	400	69957307019	£000.00

BLUE FIRE NORZON H835

- Latest Norzon grain design with self-sharpening grain for great cut rate & extended product life
- Prevents premature clogging due to open grain distribution
- The best option for coarse sanding and finishing on hard materials
- High strength paper backing with excellent tear resistance and reduced curling & edge chipping





FERR.
& NON FERR.



PAINT/VARN.
& HARD WOOD



DIAXH (mm)	GRIT	PK QTY	ART NO.	PRICE
150 	40	50	69957390933	£000.00
	60	50	69957390940	£000.00
	80	50	69957391248	£000.00
	120	100	69957391249	£000.00
150  15 holes	40	50	66254444904	£000.00
	60	50	66254444905	£000.00
	80	50	66254444908	£000.00
	120	100	66254444909	£000.00

See the Norton Automotive Aftermarket catalogue for the extended range of H835 MultiAir self-grip discs



NORTON PRO A275

- Heat treated aluminium oxide abrasive for faster cut rate and consistent scratch pattern for consistently good surface finish
- Can be used univervally on different surfaces
- No-Fit® coating prevents premature clogging for a longer lasting disc
- Fibre reinforced latex paper is flexible yet tear resistant



	DIAXH (mm)	GRIT	PK QTY	BOX QTY	ART NO.	PRICE
	76	80	50	100	63642585133	£000.00
		120	50	100	63642585145	£000.00
		150	50	100	63642585148	£000.00
		180	50	100	63642585150	£000.00
		220	50	100	63642585153	£000.00
		240	50	100	63642585156	£000.00
		320	50	100	63642569699	£000.00
		400	50	100	63642585169	£000.00
		500	50	100	69957391303	£000.00
		800	50	100	63642585172	£000.00
	150	80	100	100	63642585184	£000.00
		100	100	100	63642585186	£000.00
		120	100	100	63642569701	£000.00
		150	100	100	63642569702	£000.00
		180	100	100	63642585190	£000.00
		220	100	100	63642585194	£000.00
		240	100	100	63642585197	£000.00
		280	100	100	63642585199	£000.00
		320	100	100	63642569704	£000.00
		400	100	100	63642585214	£000.00
	150 15 holes	500	100	100	63642585217	£000.00
		600	100	100	63642585220	£000.00
		800	100	100	63642585223	£000.00
		80	100	400	66254405540	£000.00
		100	100	400	66254405542	£000.00
		120	100	400	66254405528	£000.00
		150	100	400	66254405530	£000.00
		180	100	400	66254405546	£000.00
		220	100	400	66254405548	£000.00
		240	100	400	66254405549	£000.00
280	100	400	66254405550	£000.00		
320	100	400	66254405539	£000.00		
360	100	400	66254405551	£000.00		
400	100	400	66254405552	£000.00		
500	100	400	66254405553	£000.00		
600	100	400	66254405554	£000.00		
800	100	400	66254405555	£000.00		

SELF-GRIP & BEARTEX DISCS

NEW HOLE
PATTERN AVAILABLE

DIAXH (mm)	GRIT	PK QTY	BOX QTY	ART NO.	PRICE
	80	100	400	69957307020	£000.00
	120	100	400	69957307022	£000.00
	150	100	400	69957307023	£000.00
	180	100	400	69957307027	£000.00
	220	100	400	69957307024	£000.00
	240	100	400	69957307025	£000.00
	280	100	400	69957307028	£000.00
	320	100	400	69957307029	£000.00
	360	100	400	69957307030	£000.00
	400	100	400	69957307031	£000.00
	500	100	400	69957307032	£000.00
	600	100	400	69957307033	£000.00
	800	100	400	69957307035	£000.00



H231

- Aluminium oxide abrasive for roughing, intermediate sanding & finishing of solid wood on floor & furniture applications
- Finer grits are ideal for polishing metal, plastic & leather, smoothing filler and sanding primer, within vehicle repair markets
- Semi-open / open coat (depending on grit size) reduces clogging on the disc for longer life
- Anti-static properties of the disc enable excellent surface quality



FERR.
& NON FERR.



HARD
WOOD

DIAXH (mm)	GRIT	PK QTY	BOX QTY	ART NO.	PRICE
	36	100	50	66261176734	£000.00
	60	100	100	63642516174	£000.00
	80	100	100	63642516175	£000.00
	120	100	100	63642516176	£000.00
	180	100	100	63642537389	£000.00
	240	100	100	69957360184	£000.00
	320	100	100	63642537390	£000.00
	36	100	50	63642551458	£000.00
	40	100	100	63642531875	£000.00
	50	100	100	69957360119	£000.00
	60	100	100	63642519158	£000.00
	80	100	100	63642546787	£000.00
	100	100	100	63642531872	£000.00
	120	100	100	63642531871	£000.00
	150	100	100	69957360170	£000.00
	180	100	100	63642536755	£000.00
	240	100	100	63642546797	£000.00





NORTON PRO FILM Q275 **++++**

- Heat-treated aluminium oxide grain for fast material removal and excellent performance on paint, varnish and fillers
- Flexible film backing is resistant to tearing and provides a consistent scratch pattern which reduces rework
- No-Fil® layer on the abrasive prevents dust build-up during sanding for significantly longer disc life
- Self-grip system for quick & easy disc changing, reducing process time

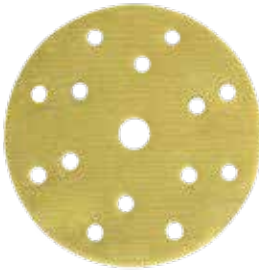

PAINT/VARN,
HARD & SOFT WOOD

	DIAXH (mm)	GRIT	PK QTY	BOX QTY	ART NO.	PRICE
  150 15 holes	80		100	400	77696085879	£000.00
	120		100	400	77696088028	£000.00
	150		100	400	77696088145	£000.00
	180		100	400	77696088146	£000.00
	220		100	400	77696088147	£000.00
	240		100	400	77696088149	£000.00
	320		100	400	77696088150	£000.00
	400		100	400	77696088151	£000.00
	500		100	400	77696088152	£000.00
	600		100	400	77696088153	£000.00
	800		100	400	77696088154	£000.00
	1000		100	400	77696088155	£000.00
	1200		100	400	77696088156	£000.00
	1500		100	400	77696088388	£000.00



A290 **+++**

- Aluminium oxide grain for good material removal on paint, varnish and fillers
- Flexible paper backing is resistant to tearing and provides a consistent scratch pattern which reduces rework
- No-Fil® layer prevents dust build-up during sanding for good disc life
- Self-grip system for quick & easy disc changing, reducing process time

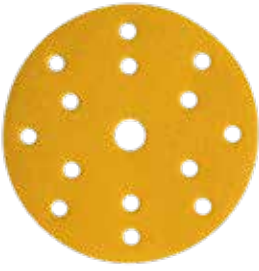

FERR.
& NON FERR.

PAINT/VARN,
HARD & SOFT WOOD

	DIAXH (mm)	GRIT	PK QTY	BOX QTY	ART NO.	PRICE
  150 15 holes	80		100	400	66261108767	£000.00
	120		100	400	66261108803	£000.00
	150		100	400	66261108804	£000.00
	180		100	400	66261108805	£000.00
	220		100	400	66261108806	£000.00
	240		100	400	66261108807	£000.00
	320		100	400	66261108809	£000.00
	400		100	400	66261108810	£000.00
	500		100	400	66261108811	£000.00

See the Norton Automotive Aftermarket catalogue for the extended range of A290 discs



Dimensions Key: DIM = Dimensions, DIA = Diameter, H = Hole

SELF-GRIP & BEARTEX DISCS

BEARTEX

- 3 dimensional disc that conforms to work surface & provides a uniform finish
- Gentle action that easily removes burrs without affecting the dimension of the workpiece
- Non-loading and ideal for finishing solid surface materials
- In Self Grip and Plain backing



	DIAXH (mm)	GRADE	CAP CODE	PK QTY	ART NO.	PRICE
	150	BEARTEX SELF-GRIP DUST HOLE DISCS				
	 7 holes	F2560	Very fine A	10	69957383151	£000.00
		F4802	Ultra fine S	10	69957383158	£000.00
		F2801	Micro fine A	10	69957383162	£000.00
		BEARTEX SELF-GRIP PLAIN DISCS				
		F2560	Very fine A	10	63642574240	£000.00
		F4660	Ultra fine S	10	63642581769	£000.00
BEARTEX PLAIN DISCS (WITHOUT SELF-GRIP)						
F2560	Very fine A	10	63642557497	£000.00		
F4807	Ultra fine S	10	63642557498	£000.00		

NEW BEARTEX

	150	BEARTEX SELF-GRIP PLAIN DISCS				
	F2316	Medium A Heavy duty	20	66261121312	£000.00	







SELF-GRIP BACK-UP PADS

PRODUCT SELECTION GUIDE BACK-UP PADS

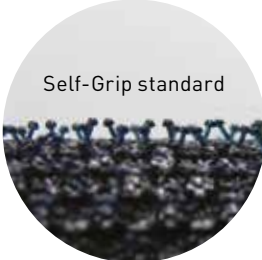
APPLICATION	DENSITY
Heavy duty sanding, best for flattening surfaces or dimensioning	HARD Blue Rubber
Scuffing, shaping, sanding & finishing For use on filler, primer, paint, clear coat, wood, plaster, composites & metal	MEDIUM Black Rubber
Final sanding, to obtain the best finishes	SOFT Orange Foam / Rubber

MACHINE	ATTACHMENT TYPE
Electrical angle grinder	M14
Electrical & pneumatic grinders (US tools)	5/8
Festo orbital sander	M8
Other orbital sanders	5/16

Packed in clear individual display box including: safety recommendations, product information, mounting instructions, versatile attachment system (Festool M8 and standard 5/16) and allen wrench.

	DIM DIAxH (mm)	THREAD	DENSITY	PK QTY	ART NO.	PRICE
 <p>Self-Grip standard</p> <p>*The 76mm back-up pad is a universal attachment system for both Self-Grip and self-adhesive discs. It provides the maximum flexibility and optimal finishing results. The Self-Grip DUO combines an innovative design of gripping structures in the shape of flat-top mushrooms which provides a highly uniform finish while allowing both self-adhesive and Self-Grip discs to be used on this unique system</p>	76	5/16"	Medium	6	63642567810*	£000.00
		No holes				
	125	5/16"	Medium	3	69957350739	£000.00
		8 holes				
	125	M14	Medium	3	69957350744	£000.00
		No holes				
150	5/16 & M8	Medium	1	66623338436	£000.00	
	No holes					
150	M14	Medium	3	63642567812	£000.00	
	No holes					
150	5/16 & M8	Hard	1	66623338451	£000.00	
	15 holes	Medium	1	66623338450	£000.00	
		Soft	1	66623338452	£000.00	

FOAM INTERFACE BACK-UP PADS SELF-GRIP



	DIA (mm)	PK QTY	ART NO.	PRICE
	76	10	69957394589	£000.00
	150	10	07660719360	£000.00

Dimensions Key: DIM = Dimensions, DIA = Diameter



Specially designed to give optimum results with very fine grit abrasives, the Norton foam interface easily conforms to contours. The interfaces are specifically developed for finishing operations to reduce risk of scratching the work piece. Use the foam interface between the Norton self-grip back-up pad and the self-grip abrasive disc.



HOLE PATTERNS FOR DISCS AVAILABLE AS MADE-TO-ORDER

Other sizes and hole patterns available on request

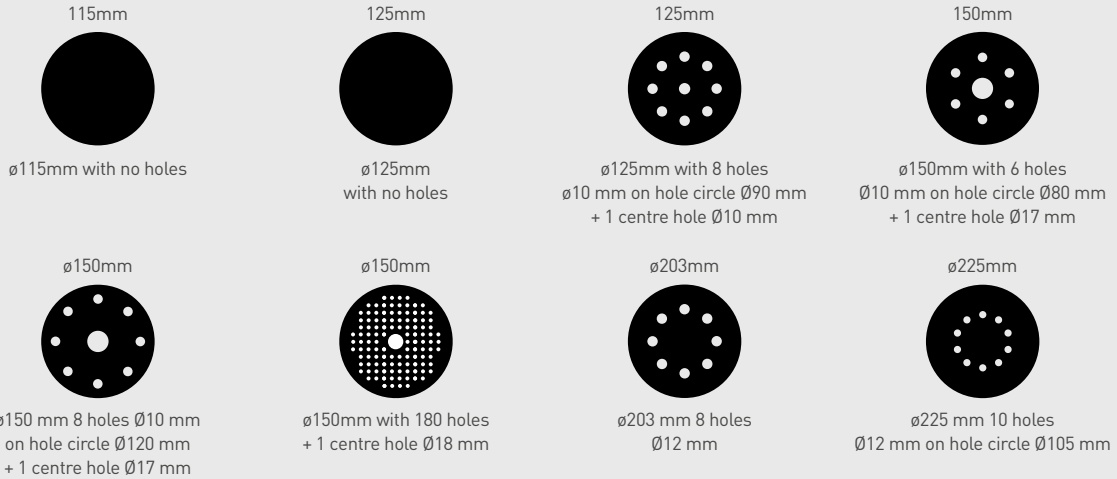

MADE-TO-ORDER PRODUCT AVAILABILITY

FOR SELF-GRIP DISCS

PRODUCT / GRIT	36	40	60	80	120	150	180	220	240	280	320	400	500	600	800	1000	1200	1500	
Norton Pro Plus A975				•	•	•	•	•	•	•	•	•	•	•	•				
Blue Fire Norzon H835F		•	•	•	•		•												
Norton Pro A275				•	•	•	•	•	•	•	•	•	•	•	•				
H231	•	•	•	•	•	•	•		•		•								
Norton Pro Film Q275				•	•	•	•	•	•		•	•	•	•	•	•	•	•	
H425*	•	•	•	•	•		•	•			•	•		•	•				
A290			•	•	•	•	•	•	•	•	•	•	•						

* Available only as MTO

MINIMUM ORDER QUANTITY

DIAMETER (mm)	MINIMUM ORDER QUANTITY
Up to 50mm	4000 pieces
51 up to 90mm	2500 pieces
91 up to 125mm	2000 pieces
126 up to 200mm	1000 pieces
201 up to 420mm	200 pieces
Over 421mm	25 pieces

Norton offers a variety of discs, including the Multi-Air family, featuring Norton Cyclonic, the latest generation of discs for all applications from sanding to polishing.

For more information, see the Norton Automotive Catalogue, or contact your local sales representative.



SCREENBACK DISCS FOR WALL & CEILING SANDING

Norton offers a complete solution of screenback discs to suit the most common applications including ceiling and wooden floor sanding.

PRODUCT SELECTION GUIDE

Highly recommended ●
Recommended ◐



MATERIALS	APPLICATIONS	Q43N	Q421
		+++	+++
Wall & ceiling sanding	Surface preparation	●	◐
Wood floor sanding	Surface preparation	◐	●
	Between coats	◐	●

Q43N +++

- Sharp silicon carbide grain for aggressive and fast cut
- Open-mesh structure for reduced clogging & longer life
- Ideal for wall & ceiling surface preparation.
- Open self-grip backing can be used on machines with dust extraction to reduce dust generation when sanding plaster

Q421 +++

- Silicon carbide abrasive for aggressive and fast cut
- Open-mesh backing to reduce clogging & loading
- Designed for wood floor sanding
- Can be used for wet or dry applications

PAINT/VARN, PLASTER & FILLER, HARD WOOD & SOFT WOOD



DIAXH (mm)	GRIT	PK QTY	ART NO.	PRICE
225	60	25	66623332303	£000.00
	80	25	66623332310	£000.00
	100	25	66623332311	£000.00
	120	25	66623332313	£000.00
	150	25	66623332318	£000.00
	220	25	66623332322	£000.00

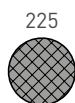

PAINT/VARN, PLASTER & FILLER, HARD WOOD & SOFT WOOD



DIAXH (mm)	GRIT	PK QTY	ART NO.	PRICE
406	60	10	66261120519	£000.00
	80	10	63642536521	£000.00
	100	10	66261120517	£000.00
	120	10	66261120516	£000.00
	150	10	63642536524	£000.00
	180	10	63642515105	£000.00
	220	10	63642552254	£000.00

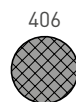

Dimensions Key: DIM = Dimensions, DIA = Diameter



PLAIN DISCS FOR FLOOR SANDING

Norton offers a range of plain sanding discs to suit all the most commonly encountered applications.

PRODUCT SELECTION GUIDE

Highly Recommended ●
Recommended ●



MATERIAL / APPLICATIONS		H425	S422 *	H231
		++++	++++	++++
Wood (floor sanding) Stone	Surface preparation	●	●	●
	Coarse sanding	●	●	
	Finishing	●	●	

*MTO

H425 **++++**

- Sharp silicon carbide abrasive grain for aggressive and high cut rate
- For dry applications only
- Strong E-weight paper ideal for use on stone surfaces



STONE HARD & SOFT WOOD



SIZE (mm)	GRIT	PK QTY	ART NO.	PRICE
150 x 12	36	50	63642546553	£000.00
	40	100	69957360199	£000.00
	50	100	63642546525	£000.00
	60	100	63642546527	£000.00
	80	100	63642546529	£000.00
	100	100	69957360218	£000.00

PLAIN DISCS FOR FLOOR SANDING

H231 **++++**

- High performance aluminium oxide abrasive with anti-static properties for longer life and excellent surface quality

- Semi-open / open coat (depending on grit size) to improve resistance to clogging
- Ideal for roughing, intermediate sanding & finishing of solid wood on floor



FERR. & NON FERR.



PAINT/VARN. HARD & SOFT WOOD



SIZE (mm)	GRIT	PK QTY	ART NO.	PRICE
350 x 40	40	10	63642540076	£000.00
	50	10	63642540078	£000.00
	60	10	63642540079	£000.00
	80	10	63642540080	£000.00

Dimensions Key: DIM = Dimensions, DIA = Diameter, H = Hole



To remove swirl marks left from edging, consider sanding the edges with an orbital sander. For best results and to avoid halos, use the same grit on the orbital sander as you previously used on the edger. The super sharp ceramic alumina grain will easily remove edger marks and produce a scratch free finish. See section selfgrip discs for further information about range.

MADE-TO-ORDER PRODUCT AVAILABILITY

PRODUCT / GRIT	24	36	40	60	80	120	150	180	220	240	280	320	400	600	800	1000
H425	•	•	•	•	•	•		•	•	•	•	•	•	•	•	•
S422*	•	•	•	•	•											
H231		•	•	•	•	•	•	•	•	•	•	•	•			

Hole patterns for discs available as MTO, other sizes and hole patterns available on request

• Available



ø 115mm with 22,23mm slotted hole
ø 125mm with 22,23mm slotted hole

MINIMUM ORDER QUANTITY

DIAMETER (mm)	MINIMUM ORDER QUANTITY
Up to 125mm	2000 pieces
126 up to 200mm	1000 pieces
201 up to 420mm	200 pieces
Over 421mm	25 pieces

AVAILABLE ON REQUEST DOUBLE SIDED ABRASIVE DISCS

Available on request a full range of 100% silicon carbide abrasive coated discs with abrasive on both sides for twice the life, quick switch, no PSA contamination, increased tear resistance. Contact your local sales representative.



BEARTEX FLOOR PADS FOR FLOOR SANDING MACHINES

Beartex offers a wide range of floor pads from stripping right through to mirror gloss finishing. For general scrubbing and cleaning applications Beartex offers two pads that will remove surface dirt and grime to get the floor back in shape before recoating or buffing.

BEARTEX FLOOR PADS

	DIA (mm)	CAP CODE	GRADE	PK QTY	ART NO.	PRICE
	STANDARD FLOOR PADS 25mm THICK					
	406	JF175	White Super Gloss	5	63642585892	£000.00
		JF176	Red Buffer	5	63642585890	£000.00
		JF177	Beige	5	63642585873	£000.00
		JF178	Black Super Strip	5	63642585841	£000.00
		JF180	Green Super Scrub	5	63642585877	£000.00
		JF181	Blue Super Clean	5	63642585868	£000.00
All standard floor pads come with an 89mm removable centrepiece						
THIN LINE FLOOR PADS 15mm THICK						
406	JU014	Black		10	63642585895	£000.00
	JF068	Green		10	63642585899	£000.00
	JF040	Beige		10	63642585903	£000.00
	JF175	White		10	63642585904	£000.00

PRODUCT SELECTION

Black Super Strip	A thick pad that is aggressive, durable, & consistent, for wet stripping applications
Green Super Scrub	A heavy duty wet scrubbing pad that will remove the toughest scuff marks in heavily soiled traffic areas
Blue Super Clean	For general duty scrubbing or heavy spray cleaning jobs
Beige	For buffing & polishing, good for light traffic areas
Red Buffer	Generally used where a high gloss finish is desired when dry or spray buffing. It can also be used for light cleaning applications
White Super Gloss	A non-abrasive polishing/buffing pad, used dry or with a fine mist to yield a mirror gloss shine

PRODUCT SELECTION GUIDE

MATERIALS / APPLICATIONS	HIGHLY RECOMMENDED	RECOMMENDED	SUITABLE
Wood - floor sanding	JF178	JF181	JF177



NORTON

SAINT-GOBAIN

COATED

WHEELS

Flap wheels
Convolute wheels
Rapid Strip wheels

108
131
136

Rapid Blend unitised wheels
High strength discs

138
140



FLAP WHEELS WITH SPINDLE

Flap wheels conform to intricate shapes and contours. Designed to deliver a consistent finish with a uniform rate of cut, they wear away evenly and without residue, continually exposing fresh abrasives.

Wheels are designed with a 3 or 6mm steel shank which runs through the wheel creating better balance, a reduction of chatter, and reduced operator fatigue. They also permit quick changes on air tools when using other abrasive products.

Flap wheels with shaft achieve their best performance at a recommended speed of 15-25m/s. Optimizing stock removal, surface finish, thermal load of the workpiece and toll wear.

PRODUCT SELECTION GUIDE

Highly recommended ●
Recommended ◐



MATERIALS	NEW NORTON QUANTUM	X-TREME R822	X-TREME S R427	NEW BDX R207Plus
	+++++	++++	++++	+++
Stainless steel, inox & duplex	●	◐		
Inconel, titanium & super alloys	●	◐		
Carbon steel, construction steel & mild steel	●	●		●
Cast iron	◐	●		●
Non-ferrous metal (brass /aluminium)			●	●
Hard & soft wood		●	◐	◐
Composite materials			●	◐
Stone, concrete			●	◐
Glass, plastic			●	◐

NORTON

SAINT-GOBAIN®



INNOVATION



NEW NORTON QUANTUM HIGH PERFORMANCE

- The best choice for use on stainless steel, inconels, chromium cobalt, titanium and extremely hard materials
- Aggressive cut removes defects quickly and effectively
- Additional supersize layer minimises heat build-up on the workpiece for a cooler cut and longer life
- CERAMIC ALUMINIUM OXIDE grain for greatest durability, longest life on tough applications and stainless steel



METAL
INOX



DIM DIAxWxS (mm)	GRIT	PK QTY	ART NO.	RECOMMENDED SPEED (RPM)	PRICE
30x15x6	40	10	66261154243	9500 - 15900	£000.00
	60	10	66261154300		£000.00
	80	10	66261154301		£000.00
	120	10	66261154871		£000.00
40x20x6	40	10	66261154302	7100 - 12000	£000.00
	60	10	66261154305		£000.00
	80	10	66261154306		£000.00
	120	10	66261154307		£000.00
60x15x6	40	10	66261154308	4800 - 7900	£000.00
	60	10	66261154312		£000.00
	80	10	66261154313		£000.00
	120	10	66261154314		£000.00
60x30x6	40	10	66261154315	4800 - 7900	£000.00
	60	10	66261154316		£000.00
	80	10	66261154318		£000.00
	120	10	66261154320		£000.00
80x30x6	40	10	66261154323	3600 - 6000	£000.00
	60	10	66261154325		£000.00
	80	10	66261154338		£000.00
	120	10	66261154339		£000.00
80x50x6	40	10	66261154340	3600 - 6000	£000.00
	60	10	66261154341		£000.00
	80	10	66261154343		£000.00
	120	10	66261154344		£000.00



Grinding on stainless steel generates a considerable amount of heat; using a Norton Pink flap wheel improves cut, finish and reduces heat generation and workpiece burn.

Dimensions Key: DIM = Dimensions, DIA = Diameter, W = Width, S = Spindle

FLAP WHEELS WITH SPINDLE

X-TREME R822

- Self-sharpening ZIRCONIA ALUMINA grain for use on stainless steel and resistant alloys
- Aggressive cutting action means a faster finish per part, maximising throughput
- Ideal for grinding, shaping, blending, edge breaking & weld removal
- Achieves a good linear finish thanks to load resistance for a regular cut rate



	DIM DIAXWX S (mm)	GRIT	PK QTY	ART NO.	RECOMMENDED SPEED (RPM)	PRICE
	30x20x6	40	10	66261033325	9500 - 15900	£000.00
		60	10	66261139984		£000.00
		80	10	66261139986		£000.00
	40x20x6	40	10	69957300004	7100 - 12000	£000.00
		60	10	69957300006		£000.00
		80	10	69957300007		£000.00
	50x20x6	40	10	66261139987	5700 - 9500	£000.00
		60	10	69957300009		£000.00
		80	10	69957300013		£000.00
60x30x6	40	10	63642539952	4800 - 7900	£000.00	
	60	10	63642536547		£000.00	
	80	10	63642539953		£000.00	
80x30x6	40	10	63642539954	3600 - 6000	£000.00	
	60	10	63642539955		£000.00	
	80	10	63642536548		£000.00	
80x50x6	40	10	69957300015	3600 - 6000	£000.00	
	60	10	63642578253		£000.00	
	80	10	69957300019		£000.00	



Reducing the working pressure and the peripheral speeds of the abrasive wheels results in reduced heat generation on the workpiece and the tool, eliminating burn marks and improving finish.

X-TREME S R427

- Hard SILICONE CARBIDE grain for use on copper, titanium, bronze, brass, non-ferrous materials, stone, glass and plastic
- Ideal for grinding, shaping, blending, edge breaking & weld removal
- Conforms to irregular shaped components and contours, for a finer and more even surface finishing
- Achieves a high initial cut and penetration, maintained throughout the life of the product



NON FERR. 	STONE 	GLASS ARISING 
---	---	---



DIM DIAxWxS (mm)	GRIT	PK QTY	ART NO.	RECOMMENDED SPEED (RPM)	PRICE
20x10x3	60	10	66261128665	14300 - 23900	€000.00
	80	10	66261128667		€000.00
	120	10	66261128668		€000.00
	150	10	66261128670		€000.00
20x20x6	60	10	66261126592	14300 - 23900	€000.00
	80	10	66261126593		€000.00
	120	10	66261126598		€000.00
30x10x6	60	10	66261127026	9500 - 15900	€000.00
	80	10	66261127027		€000.00
	120	10	66261127028		€000.00
	150	10	66261127029		€000.00
40x20x6	60	10	66261127119	7100 - 12000	€000.00
	80	10	66261127120		€000.00
	120	10	66261127122		€000.00
50x30x6	60	10	66261127246	5700 - 9500	€000.00
	80	10	66261127247		€000.00
	120	10	66261127248		€000.00
60x30x6	60	10	66261127264	4800 - 7900	€000.00
	80	10	66261127265		€000.00
	120	10	66261127266		€000.00
	150	10	66261127271		€000.00



NEW BDX R207Plus

- Excellent cut rate even at low-pressure when used for finishing operations,
- A universal product which achieves a good finish on steel and stainless steel
- New generation of premium aluminium oxide grain provides an aggressive cut yet long product life
- Conforms to the workpiece thanks to the flexible cotton backing



FERR.
& NON FERR.



	DIM DIAxWxS (mm)	GRIT	PK QTY	ART NO.	RECOMMENDED SPEED (RPM)	PRICE
3mm SHAFT						
	15x15x3	60	10	66261139936	19000 - 31800	£000.00
		80	10	66261139944		£000.00
		120	10	66261139945		£000.00
		180	10	66261139947		£000.00
		320	10	66261139948		£000.00
	20x10x3	60	10	66261139960	14300 - 23900	£000.00
		80	10	66261139962		£000.00
		120	10	66261139964		£000.00
		180	10	66261139966		£000.00
		320	10	66261139967		£000.00
	30x10x3	60	10	66261139974	9500 - 15900	£000.00
		80	10	63642536733		£000.00
		120	10	66261139976		£000.00
		180	10	66261139978		£000.00
		320	10	66261135146		£000.00
6mm SHAFT						
	20x10x6	40	10	77696007699	14300 - 23900	£000.00
		60	10	66261193703		£000.00
		80	10	66623329045		£000.00
		120	10	66261137904		£000.00
	25x20x6	40	10	66261100608	11500 - 19000	£000.00
		60	10	66261106190		£000.00
		80	10	77696086608		£000.00
		120	10	66261137918		£000.00



+25% performance upgrade

6mm SHAFT



30x10x6	40	10	66261138103	9500 - 15900	£000.00
	60	10	63642545207		£000.00
	80	10	63642537371		£000.00
	120	10	63642552728		£000.00
30x15x6	40	10	66261056890	9500 - 15900	£000.00
	60	10	63642513148		£000.00
	80	10	63642561466		£000.00
	120	10	63642551593		£000.00
	180	10	66261138106		£000.00
	240	10	63642547341		£000.00
	320	10	63642513149		£000.00
30x30x6	40	10	66261138108	9500 - 15900	£000.00
	60	10	66254410858		£000.00
	80	10	66261063210		£000.00
	120	10	66261138109		£000.00
	180	10	66623331386		£000.00
40x15x6	40	10	63642539937	7100 - 12000	£000.00
	60	10	63642533099		£000.00
	80	10	63642533098		£000.00
	120	10	63642533094		£000.00
	180	10	66261138192		£000.00
	240	10	69957360895		£000.00
40x20x6	40	10	63642539938	7100 - 12000	£000.00
	60	10	63642546771		£000.00
	80	10	63642546768		£000.00
	120	10	63642546760		£000.00
	180	10	66261066179		£000.00
	240	10	63642539939		£000.00
	320	10	63642539940		£000.00
50x20x6	40	10	63642546774	5700 - 9500	£000.00
	60	10	63642531870		£000.00
	80	10	63642533097		£000.00
	120	10	63642546759		£000.00
	180	10	66261138275		£000.00
	240	10	63642546724		£000.00
50x30x6	40	10	63642539943	5700 - 9500	£000.00
	60	10	63642534251		£000.00
	80	10	63642561879		£000.00
	120	10	63642531863		£000.00
	180	10	66261136117		£000.00
	240	10	66261138276		£000.00
60x15x6	40	10	63642546773	4800 - 7900	£000.00
	60	10	69957360901		£000.00
	80	10	63642546767		£000.00
	120	10	63642546758		£000.00
	180	10	66261138277		£000.00
	240	10	69957360903		£000.00



† +25% performance upgrade

FLAP WHEELS WITH SPINDLE

	DIM DIAxWxS (mm)	GRIT	PK QTY	ART NO.	RECOMMENDED SPEED (RPM)	PRICE
6mm SHAFT						
	60x20x6	40	10	63642536738	4800 - 7900	£000.00
		60	10	63642531869		£000.00
		80	10	63642531866		£000.00
		120	10	63642531862		£000.00
		180	10	66261138279		£000.00
		240	10	63642539770		£000.00
	60x30x6	40	10	63642536737	7100 - 12000	£000.00
		60	10	63642531868		£000.00
		80	10	63642531865		£000.00
		120	10	63642531861		£000.00
		180	10	66261090663		£000.00
		240	10	63642546694		£000.00
		320	10	63642546727		£000.00
	60x40x6	40	10	66261138280	5700 - 9500	£000.00
		60	10	66261056891		£000.00
		80	10	66261056892		£000.00
		120	10	66261056893		£000.00
		180	10	66261138281		£000.00
	80x30x6	40	10	69957360911	5700 - 9500	£000.00
		60	10	63642531867		£000.00
		80	10	63642533096		£000.00
		120	10	63642534250		£000.00
		180	10	66261138283		£000.00
	80x50x6	40	10	69957360914	5700 - 9500	£000.00
		60	10	63642559718		£000.00
		80	10	69957360916		£000.00
		120	10	69957360917		£000.00
		180	10	66261138284		£000.00



† +25% performance upgrade



To prevent unnecessary tool wear, use a coarser grit size instead of increasing contact pressure. For a finer surface finish, increase the cutting speed. Using the same grit size, the finish will be rougher on softer materials.



NEW BDX R207PLUS - SLOTTED FLAP WHEELS

- A universal product which achieves a good finish on steel and stainless steel
- The aluminium oxide grain provides an aggressive cut yet long product life
- The slotted flaps improve flexibility and ease of use, conforming easily to contours and hard to reach areas
- Good cut rate on low-pressure finishing operations with ability to leave a very good finish

	DIM DIAxWxS (mm)	GRIT	PK QTY	ART NO.	RECOMMENDED SPEED (RPM)	PRICE
SLOTTED FLAP WHEELS						
	30x15x6	40	10	66261135702	9500 - 15900	£000.00
		80	10	66261135714		£000.00
		120	10	66261135730		£000.00
		240	10	66261135732		£000.00
		320	10	66261135745		£000.00
	40x20x6	40	10	66261135775	7100 - 12000	£000.00
		80	10	66261135779		£000.00
		120	10	66261135782		£000.00
		240	10	66261135784		£000.00
		320	10	66261135785		£000.00
	60x30x6	40	10	66261135790	4800 - 7900	£000.00
		80	10	66261135792		£000.00
		120	10	66261135794		£000.00
		240	10	66261135795		£000.00
		320	10	66261135796		£000.00
	80x50x6	40	10	66261135797	3600 - 6000	£000.00
		80	10	66261135799		£000.00
		120	10	66261135801		£000.00
		240	10	66261135803		£000.00
		320	10	66261135804		£000.00



† +25% performance upgrade

Dimensions Key: DIM = Dimensions, DIA = Diameter, W = Width, S = Spindle

MADE-TO-ORDER PRODUCT AVAILABILITY

PRODUCT / GRIT	36	40	60	80	120	150	180	240	320
NORTON QUANTUM R928		•	•	•	•				
X-TREME R822	•	•	•	•	•	•			
X-TREME S R427	•	•	•	•	•	•	•	•	
BDX R207		•	•	•	•	•	•	•	•

MINIMUM ORDER QUANTITY

DIAMETER (mm)	MINIMUM ORDER QUANTITY
20	250 pieces
25	250 pieces
30	250 pieces
40	250 pieces
50	250 pieces
60	250 pieces
80	250 pieces



BEARTEX SPINDLE MOUNTED FLAP WHEELS

Non-woven surface finishing flap wheels are an ideal choice for a variety of blending and finishing applications common in the metal fabrication, welding and polishing industries. Flap wheels conform to intricate shapes and contours. Designed to deliver a consistent finish with a uniform rate of cut, they wear away continually, exposing fresh abrasives.

There are two types of non-woven flap wheels: those made with only non-woven flaps, where finishing is the primary application, and interleaved wheels, made with coated abrasive and non-woven flaps. The interleaved wheels are less conformable but more rigid for higher stock removal and must always be run in the direction indicated by the arrow on the product label.

FLAP WHEEL TYPES

Mounted on a 6mm diameter spindle, for use on straight line die grinders for removal of oxidation, paint, corrosion and generating grain finishes.

BEARTEX NON-WOVEN FLAP WHEELS

- Non-woven only abrasive flaps.
- Ideal for finishing large and awkward components.
- Can be used for metals, wood, composite and plastics.
- Less aggressive than conventional coated abrasive flap wheels.

BEARTEX INTERLEAVED FLAP WHEELS

- Beartex non-woven abrasive interleaved with coated abrasive
- Soft yet aggressive, creating a "firmer" wheel that provides a higher rate of cut.
- The ratio of coated abrasive to non woven flaps can be altered to suit particular applications.
- Ideal for deburring and grain finishing on stainless steel.



APPLICATION GUIDE

	COARSE (GRINDING) ←				FINE (FINISHING) →			
COATED GRIT	40	60	80	120	180	240	320	
NON-WOVEN GRADE	COARSE		MEDIUM		FINE	VERY FINE		
Preparing metal for painting		●	●					
Blending out medium machine marks		●	●					
Blending metal surfaces			●	●				
Applying light scratch pattern			●	●	●			
Fine blending and cleaning				●	●	●		
Metal finishing and polishing						●	●	

← COATED / INTERLEAF FLAP WHEELS NON-WOVEN FLAP WHEEL →

BEARTEX FLAP WHEELS HEAVY DUTY

- Durable, heavy duty wheel for blending & finishing with up to 2x longer life
- Enhanced Clean Bond™ resin coverage for consistent uniform surface finish, with no smearing
- Premium aluminum oxide grain for improved cut rate



FERR. & NON FERR. 

	DIM DIAxWxS (mm)	GRADE	CAP CODE	PK QTY	ART NO.	PRICE
	60x30x6	Medium A	F2316	10	66261117932	£000.00
	80x40x6	Medium A	F2316	10	66261117934	£000.00
	100x50x6	Medium A	F2316	10	66261117936	£000.00

Dimensions Key: DIM = Dimensions, DIA = Diameter, W = Width, S = Spindle

BEARTEX FLAP WHEELS

- Provides a gentle cushioning action for use on contoured & shaped surfaces
- Consistent & uniform finish with no risk of gouging
- Vibration free for a consistent finish without smearing or component discolouration



FERR. & NON FERR. 

	DIM DIAxWxS (mm)	GRADE	INTERLEAVED GRIT	CAP CODE	PK QTY	ART NO.	PRICE
	30x20x6	Medium A	-	F2300	10	66261032155	£000.00
		Fine A	-	F2401	10	66261032160	£000.00
	40x20x6	Medium A	-	F2300	10	66261032156	£000.00
		Fine A	-	F2401	10	66261032161	£000.00
		Very Fine A	-	F2501	10	66261032165	£000.00

Dimensions Key: DIM = Dimensions, DIA = Diameter, W = Width, S = Spindle

BEARTEX SPINDLE MOUNTED FLAP WHEELS

DIM DIAxWxS (mm)	GRADE	INTERLEAVED GRIT	CAP CODE	PK QTY	ART NO.	PRICE
60x30x6	Fine A Interleaved	60	F2401	10	63642549639	£000.00
	Fine A Interleaved	100	F2401	10	63642549640	£000.00
	Fine A Interleaved	150	F2401	10	63642549641	£000.00
	Coarse	-	F2202	10	66261032167	£000.00
	Medium A	-	F2300	10	66261032157	£000.00
	Medium S	-	F4300	10	66261053048	£000.00
	Fine A	-	F2401	10	63642549650	£000.00
	Fine S	-	F4401	10	63642515902	£000.00
	Very Fine A	-	F2501	10	63642515905	£000.00
80x50x6	Fine A Interleaved	60	F2401	10	7660705179	£000.00
	Fine A Interleaved	100	F2401	10	63642515544	£000.00
	Fine A Interleaved	150	F2401	10	63642515545	£000.00
	Coarse	-	F2202	10	63642586113	£000.00
	Medium S	-	F4300	10	66261053053	£000.00
	Fine A	-	F2401	10	63642515583	£000.00
	Fine S	-	F4401	10	63642515614	£000.00
	Very Fine A	-	F2501	10	63642515628	£000.00
	100x50x6	Fine A Interleaved	60	F2401	10	63642515907
Fine A Interleaved		100	F2401	10	63642515908	£000.00
Fine A Interleaved		150	F2401	10	63642515909	£000.00
Fine A		-	F2401	10	63642515903	£000.00
Fine S		-	F4401	10	63642515904	£000.00
Very Fine A		-	F2501	10	63642515906	£000.00

Other specifications are available MT0. Please contact your local sales or customer service representative for more information.

BEARTEX FLAP WHEELS TR+ MOUNTED



- Where a quick change facility in a continuous operation is beneficial



FERR.
& NON FERR.



DIM DIAxWxS (mm)	GRADE	CAP CODE	PK QTY	ART NO.	PRICE
60x30xTR	Medium A	F2316	10	66261124072	£000.00

Dimensions Key: DIM = Dimensions, DIA/D = Diameter, W = Width, S = Spindle

Use with TR+ holder for quick change capability.
Also available in interleaved and TR+ in large and small diameter wheels.

BACK-UP PADS TR+ ATTACHMENT (TR+ - SL4)

TR+



TYPE	DENSITY	MAX RPM	PK QTY	ART NO.	PRICE
Plastic back-up pad with 6mm spindle	Hard	15000	1	63642586196	£000.00



For 100mm Speedlok TR+ discs



PNEUMATIC DIE GRINDER GRINDING TOOLS AND KITS

Our new Norton pneumatic die grinder quickly and comfortably accomplishes many portable applications without changing machines – including jobs for abrasive specialties (cartridge and spiral rolls..., small diameter flap wheels, mounted points, and carbide burrs. Equip your new die grinder with the complete line of Norton die-grinding abrasive products and it will run longer, at peak efficiency.

NEW PNEUMATIC DIE GRINDER **+++**

WITH 6MM COLLET, MAX RPM 25000 (0.9 HP)

- Extremely versatile and productivity-enhancing; includes a 6mm collet to accommodate numerous abrasive products: specialties (including cartridge and spiral rolls, spirabands, cones), mounted flap wheels, mounted points, and carbide burrs
- Excellent value proposition: this is solid tool sold at a GOOD-tier price
- Achieve better tool handling, along with reduced fatigue, from the ergonomic and streamlined non-slip grip
- Their small size also enhances control and finishes while their light weight provides additional control, less vibration for operator comfort, and the ability to get into small parts
- Double-bearing spindle generates superb concentricity, reducing vibrations and allowing longer use, while producing finer finishes



COLLET DIAMETER (mm)	HORSEPOWER	TOOL WEIGHT	AIR CONSUMPTION (l/min)	RECOMMENDED OPERATING PRESSURE:	ART NO.	PRICE
6	0.9	0.65 kg	85	6.2 bar	69957341008	£000.00



SPEC CHECK

Air tools require regular lubrication throughout the life of the tool. The air motor and bearing use compressed air to power the tool. Because moisture in compressed air will rust the air motor, it must be lubricated daily. An inline oiling device is recommended. Before using the machine add 1-2 drops of oil in the machine air inlet.



This is an **UNGUARDED** tool and should **NEVER** be used with cut-off discs. Never use any product that has a MAX RPM rating less than the RPM marked on the tool.

NORTON PNEUMATIC DIE GRINDER PROFESSIONAL KIT GRINDING TOOLS AND KITS

Our new Norton pneumatic die grinder quickly and comfortably accomplishes many portable applications without changing machines – including jobs for abrasive specialties (cartridge and spiral rolls...), small diameter flap wheels, mounted points, and carbide burrs. Equip your new die grinder with the complete line of Norton die-grinding abrasive products and it will run longer, at peak efficiency.



NEW PNEUMATIC DIE GRINDER **+++**

COMPATIBLE WITH 6MM SHAFTS TOOLS,
MAX RPM 25000 (0.9 HP)

- A complete assortment of our premium specialties (including cartridge, spirabands, cones), mounted flap wheels, mounted points, and carbide burrs, complete with pneumatic die grinder machine

KIT CONTENTS	ITEM ART NO.	PK QTY	KIT ART NO.	PRICE
NORTON pneumatic Die Grinder (6mm) 25 000 RPM	69957341008	1		
Norton professional tool bag: Polybag 600D 38x23x28cm	310518514	1		
BURRS SHAPE A12.7X25 CUT D 60L70 NOR BDX	66261146497	1		
BURRS SHAPE F12.7X25 CUT D 60L70 NOR BDX	66261146540	1		
52_A21M_25x25xM4M_4Z8W48A800VS.	61463688956	10		
52_A38M_25x25xM4M_86A60PVS.	66253054946	10		
FLW FWS 30x15 R928 NOR P60 6mmSK(C)	66261154300	10		
FLW FWS 30x15 R207PLUS NOR P120 6mmSK(C)	63642551593	10		
FLW FWS 30x20 F2309 NOR A0MEMD 6mmSK(C)	66261032155	5	69957366029	£000.00
UNW STD 1"x1"x3/16" U4401 NOR SIFI2	66261014883	10		
MANDREL THD SML WHL 25x5MM CPM-12 GEN	66261077832	1		
SPE ZSB 15x30R920 NOR P60	66623331569	10		
ML [ZSB] 15x30x6 Med NOR	7660705182	1		
SPE ZCO 20x15x63 R822 NOR P50 OVL	66261176657	10		
COSMO EXP 20/14-63 PURPLE	7660740439	1		
SPE ZPE 6x38x3 R920 NOR C80	66261128986	25		
ML [ZPE] 3,2x25x6 CRM5 Steel NOR	63642556791	1		



FLAP WHEELS WITH INTERNAL M14 THREAD

Norton flap wheels with internal M14 thread are ideal for sanding contours and uneven surfaces, while delivering a uniform cut rate for a consistent finish when blending, deburring, and finishing in metal fabrication and welding industries. Flap wheels conform to intricate shapes and contours and are easy to operate; no adjustments, dressing or preparation is required before or during the operation.

Norton flap wheels are more forgiving than other abrasives, reducing the risk of flattening, gouging or surface deformation, meaning fewer rejected parts, and better long term productivity.

NEW NORTON QUANTUM HIGH PERFORMANCE **+++++ INNOVATION**

- Excellent results on stainless steel, inconels, chromium cobalt, titanium and extremely hard materials
- Aggressive cut removes defects quickly and effectively
- Additional supsize layer minimises heat build-up on the workpiece for a cooler cut and longer life
- CERAMIC ALUMINIUM OXIDE grain provides the longest life even in tough applications



METAL
INOX



	DIM DIAxWxTH (mm)	GRIT	PK QTY	ART NO.	RECOMMENDED SPEED (RPM)	PRICE
	115x20 M14	40	5	69957307345	6700 - 8300	£000.00
		60	5	69957307350		£000.00
		80	5	69957307353		£000.00
		120	5	69957307354		£000.00
	125x20 M14	40	5	69957307355	6700 - 8300	£000.00
		60	5	69957307356		£000.00
		80	5	69957307359		£000.00
		120	5	69957307360		£000.00

FLAP WHEELS WITH INTERNAL M14 THREAD

NEW BDX R207Plus **+++**

- A universal wheel for use on steel and stainless steel, can also be used for paint removal and on plastic or wood
- Excellent cut rate in low-pressure finishing operations, leaves a very good finish
- The new generation of premium aluminium oxide grain provides an aggressive cut yet long product life
- Quick and easy to mount on an angle grinder



FERR. & NON FERR.



	DIM DIAxWxTH (mm)	GRIT	PK QTY	ART NO.	RECOMMENDED SPEED (RPM)	PRICE
	115x20 M14	40	5	66261121351	6700 - 8300	£000.00
		60	5	66261121353		£000.00
		80	5	66261121411		£000.00
		120	5	66261121415		£000.00
		125x20 M14	40	5		66261121426
		60	5	66261121427		£000.00
		80	5	66261121428		£000.00
		120	5	66261121429		£000.00
		180	5	66261121432		£000.00
		320	5	66261121435		£000.00



+25% performance upgrade

Dimensions Key: DIM = Dimensions, DIA = Diameter, W = Width, TH = Thread



To prevent unnecessary tool wear, use a coarser grit size instead of increasing contact pressure. For a finer surface finish, increase the cutting speed. Using the same grit size, the finish will be rougher on softer materials.



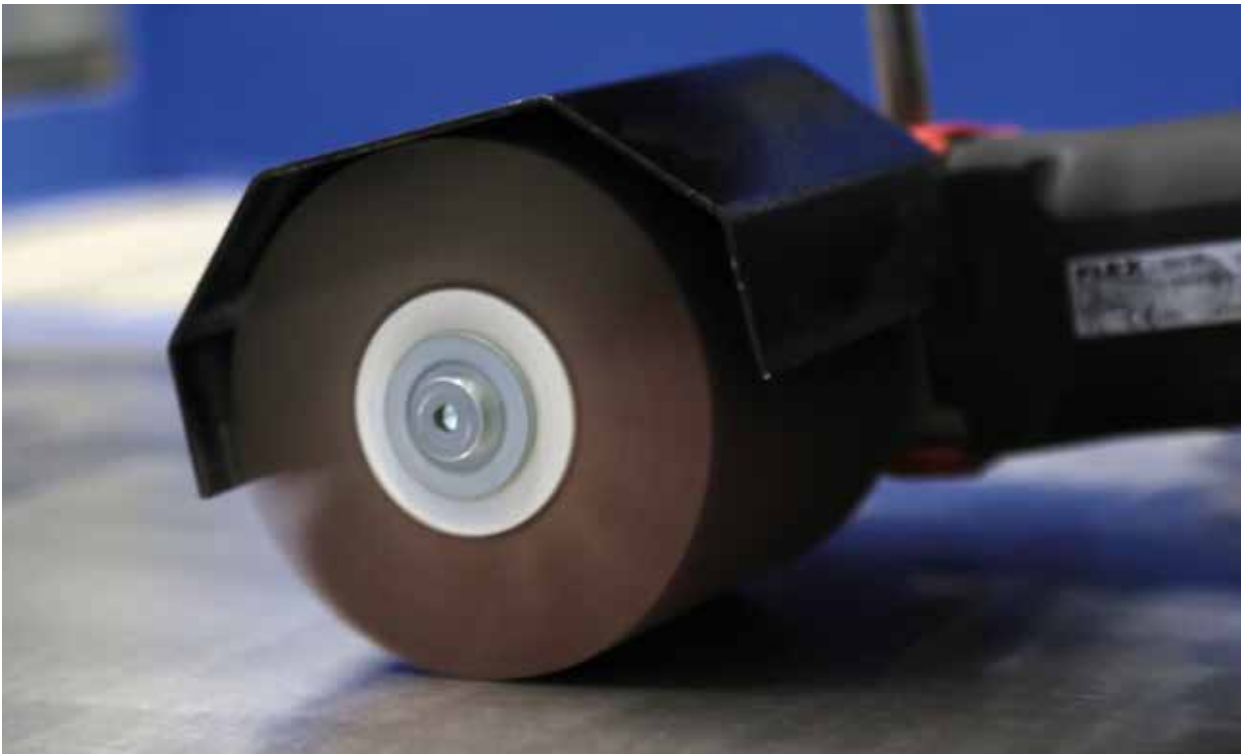

FLAP WHEELS FOR SATINEX MACHINES

These versatile wheels are used on portable machines and are compatible with the most commonly used systems. Satinex wheels consist of a core of radially bonded strips of abrasive flaps, ideal for fine grinding work on large areas and uneven surfaces, delivering a consistent finish with a uniform rate of cut in blending, deburring and finishing applications in metal fabrication, welding and polishing industries. They can also be used for decorative finishing, thanks to the product structure of abrasive flaps anchored by a resin core at the centre, which provides excellent flexibility and very smooth surface finish.

Flange mounted flap wheels perform best at a recommended speed of 15-30m/s. At this speed, abrasive flaps stand up straight due to the centrifugal force, with only the edges in contact with the workpiece, optimizing stock removal and surface finish whilst avoiding thermal load of the workpiece and tool wear.

X-TREME R822

- Self-shapening Zirconia alumina grain for use on stainless steel and resistant alloys
- Ideal for grinding, shaping, blending, edge breaking & weld removal
- Aggressive cutting action means a faster finish per part, maximising throughput
- Achieves a good linear finish thanks to load resistance for a regular cut rate



METAL
INOX



	DIM DIAxWxS (mm)	GRIT	PK QTY	ART NO.	RECOMMENDED SPEED (RPM)	PRICE
	100x50x19,1	40	1	66261139933	2900 - 5800	£000.00
		60	1	66261138387		£000.00
		80	1	66261138388		£000.00
	100x100x19,1	40	1	66261139934	2900 - 5800	£000.00
		60	1	66261138390		£000.00
		80	1	66261138391		£000.00

Dimensions Key: DIM = Dimensions, DIA = Diameter, W = Width, S = Spindle

FLAP WHEELS FOR SATINEX MACHINES

NEW BDX R207Plus

- An excellent choice where superior finish is required, or for low-pressure applications
- A universal wheel for use on steel and stainless steel, can also be used for paint removal and on plastic or wood
- The new generation of premium aluminium oxide grain provides an aggressive cut yet long product life
- Conforms easily to the workpiece



FERR.
& NON FERR.



	DIM DIAxWxS (mm)	GRIT	PK QTY	ART NO.	RECOMMENDED SPEED (RPM)	PRICE
	100x50x19,1	40	5	66261139842	2900 - 5800	£000.00
		60	5	66261138372		£000.00
		80	5	66261138373		£000.00
	100x100x19,1	40	5	66261139847	2900 - 5800	£000.00
		60	5	66261138377		£000.00
		80	5	66261138378		£000.00

Dimensions Key: DIM = Dimensions, DIA = Diameter, W = Width, S = Spindle

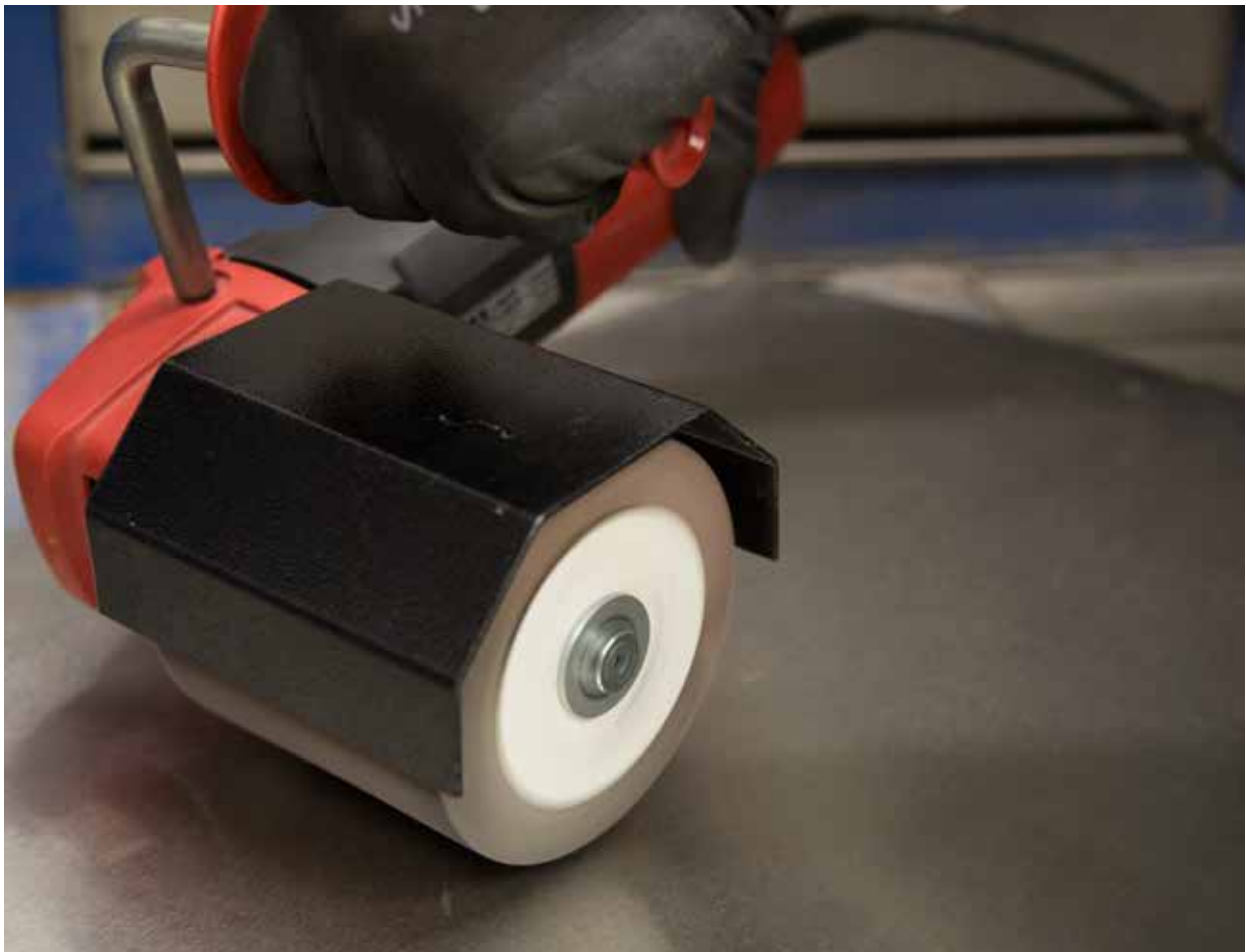



BEARTEX WHEELS FOR SATINEX MACHINES

Beartex Satinex wheels provide a cushioned abrasive action which not only works well on flat areas, but is also ideal for use in finishing operations on uneven surfaces. These versatile wheels are used on portable machines.

BEARTEX

- For use on portable, variable speed machines
- Wide range of different grades
- For applications from rust removal to a satin finish
- Flap wheel construction ensures a perfect linear finish for repair & touch-up jobs



APPLICATION GUIDE

INDUSTRY	APPLICATION	PRODUCTS
Stainless steel fabricators	Grain finishing on sheets, removing imperfections	Satinex non-woven Medium A
Architectural hardware	Finishing brass aluminium & steel, satin finishing	Satinex non-woven fine and very fine for bright linear finishes
Metal working	Cleaning and removing scales, oxide and rust	Satinex RapidStrip
Food processing	Weld blending, satin finishing with extended life	Satinex polyurethane

BEARTEX WHEELS FOR SATINEX MACHINES

SATINEX NON WOVEN



FERR.
& INOX

APPLICATION	DIM DxTxB (mm)	CAP CODE	GRADE	MAX RPM	PK QTY	ART NO.	PRICE
Blending / satin finishing	110x100x19	F2200	Coarse A	5700	1	63642557218	£000.00
		F2316	Medium A Heavy Duty	5700	1	66261124068	£000.00
		F2300	Medium A	5700	1	63642557404	£000.00
		F2400	Fine A	5700	1	63642557405	£000.00
		F2504	Very Fine A	5700	1	63642557406	£000.00
		F4306	Medium S	5700	1	63642556878	£000.00

SATINEX INTERLEAVED

APPLICATION	DIM DxTxB (mm)	CAP CODE	GRADE	MAX RPM	PK QTY	ART NO.	PRICE
Blending / fine graining	110x100x19	F2200	Coarse A + P80	5700	1	63642557407	£000.00
		F2309	Medium A + P80	5700	1	07660707431	£000.00
		F2300	Medium A + P150	5700	1	63642557408	£000.00
		F4402	Fine S + P150	5700	1	63642556741	£000.00

SATINEX POLYURETHANE

APPLICATION	DIM DxTxB (mm)	CAP CODE	GRADE	MAX RPM	PK QTY	ART NO.	PRICE
Blending / satin finishing	110x100x19	P2W01	Coarse	5700	1	63642557410	£000.00

SATINEX RAPID STRIP

APPLICATION	DIM DxTxB (mm)	CAP CODE	GRADE	MAX RPM	PK QTY	ART NO.	PRICE
Cleaning / corrosion removal	110x100x19	R4101	Extra Coarse (SiC)	5700	1	63642557184	£000.00

SATINEX NON WOVEN

APPLICATION	DIM DxTxB (mm)	CAP CODE	GRADE	MAX RPM	PK QTY	ART NO.	PRICE
Cleaning / blending / finishing	110x50x19	F2200	Coarse A	5700	2	69957336455	£000.00
		F2316	Medium A Heavy Duty	5700	2	66261124067	£000.00

SATINEX INTERLEAVED

APPLICATION	DIM DxTxB (mm)	CAP CODE	GRADE	MAX RPM	PK QTY	ART NO.	PRICE
Blending / fine graining	110x50x19	F2200	Coarse A + P60	5700	2	66261180082	£000.00

Dimensions Key: DIM = Dimensions, D = Diameter, T = Thickness, B = Bore
Other configurations and sizes are available



FLANGE MOUNTED FLAP WHEELS

Flange mounted flap wheels have a continual rate of wear as they constantly expose new abrasive grains when in use. Ideal for sanding contours and uneven surfaces as they conform well to intricate shapes thanks to the flap construction. The product structure; abrasive flaps anchored by a resin core at the centre, provides great flexibility and very smooth surface finish. A consistent finish is always maintained due to the uniform cut rate, especially on aluminum and stainless steel parts where they can be used for blending, deburring, finishing applications in metal fabrication, welding and polishing.

Flange mounted flap wheels perform best at a recommended speed of 38-42m/s. At this speed, the abrasive flaps stand up straight due to the centrifugal force, where only the edges are in contact with the workpiece, optimizing stock removal and surface finish whilst avoiding thermal load of the workpiece and tool wear.

NEW BDX R207Plus **+++**

- The ultimate choice where superior finish is required or for low-pressure applications
- For universal use on steel and stainless steel, can also be used for paint removal and on plastic or wood
- Excellent cut rate, imparting a good finish on curves and contours
- The new generation of premium aluminium oxide grain provides aggressive cut and longer life



FERR.
& NON FERR.



	DIM DIAxWxB (mm)	GRIT	PK QTY	ART NO.	RECOMMENDED SPEED (RPM)	PRICE
	100x25x25	40	2	63642547168	2900 - 5800	£000.00
		60	2	66261140370		£000.00
		80	2	63642574115		£000.00
	100x50x25	40	1	66261140373	2900 - 5800	£000.00
		60	1	66261140375		£000.00
		80	1	66261140376		£000.00
	150x25x25	40	2	66623317452	4800 - 5400	£000.00
		60	2	63642563719		£000.00
		80	2	63642546728		£000.00
120		2	63642546740	£000.00		
180		2	63642546749	£000.00		
240		2	77696046364	£000.00		

FLANGE MOUNTED FLAP WHEELS

DIM DIAxWxB (mm)	GRIT	PK QTY	ART NO.	RECOMMENDED SPEED (RPM)	PRICE
150x50x25	40	1	66261140555	4800 - 5400	£000.00
	60	1	63642546712		£000.00
	80	1	63642546729		£000.00
	120	1	66261140556		£000.00
	180	1	66261140558		£000.00
	240	1	63642545892		£000.00
165x25x32	40	2	63642547170	4300 - 4900	£000.00
	60	2	63642546711		£000.00
	80	2	63642546730		£000.00
	120	2	63642546742		£000.00
	180	2	66261140560		£000.00
	240	2	66261140606		£000.00
	320	2	66261140607		£000.00
165x50x32	40	1	66261140608	4300 - 4900	£000.00
	60	1	63642561961		£000.00
	80	1	63642546731		£000.00
	120	1	63642546743		£000.00
	180	1	63642546751		£000.00
	240	1	66261140610		£000.00
	320	1	63642545894		£000.00
200x25x35	60	1	63642547173	3600 - 4000	£000.00
	80	1	63642547175		£000.00
	120	1	66261140611		£000.00
	180	1	63642512956		£000.00
200x50x35	60	1	66261140613	3600 - 4000	£000.00
	80	1	63642546732		£000.00
	120	1	66261140614		£000.00
250x50x35	60	1	66261140617	2900 - 3200	£000.00
	80	1	63642546733		£000.00
	120	1	63642546745		£000.00

Dimensions Key: DIM = Dimensions, DIA = Diameter, W = Width, B = Bore



BEARTEX FLANGE MOUNTED FLAP WHEELS

Formed by mounting sheets of Beartex around a centre core. The tightly packed piece forms the spokes of a wheel. This construction makes flap wheels the most conformable of all Beartex wheels providing a cushioning action which is ideal for use on uneven or irregular surfaces, as well as flat areas.

BEARTEX FLAP WHEEL TYPES

1. NON-WOVEN FLAP WHEELS (standard for stock)
2. INTERLEAVED FLAP WHEELS (made-to-order)

Both in variable sizes with widths from 10 to 2000mm.
Available in a wide range of abrasive types, grits and densities for metal and woodworking.

INTERLEAVED FLAP WHEELS

Interleaved wheels are more aggressive than standard Beartex, due to the coated abrasive flaps found inside the wheel. This creates a "firmer" wheel that provides a higher rate of cut. The ratio of coated flaps to non-woven flaps can be altered to suit particular applications.

Ideal for deburring and grain finishing on stainless steel.
Available in both spindle and flange mounted versions.
Flange mounted interleaved wheels can be shaped to match the profile, e.g: a wood moulding.

DENSITIES

The different densities facilitate a versatility ranging from soft cushioning pads to hard cleaning and finishing tools. The density of a wheel can be increased (hardened) by adding more flaps, as shown below:

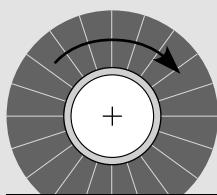

SD: Soft density

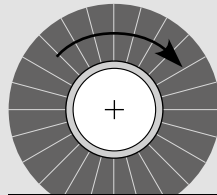

MD: Medium density

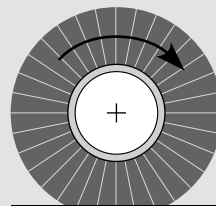

HD: Hard density

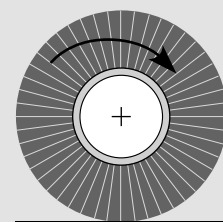

HDEX: Extra Hard density

BEARTEX FLANGE MOUNTED FLAP WHEELS

BEARTEX FLAP WHEEL APPLICATION GUIDE

SGA MCC	GRADE	MD	OLD QUALITY NAME	GRAIN TYPE	APPLICATION
F2212	Coarse A	DAB01	-	Aluminium Oxide	<ul style="list-style-type: none"> Aggressive, very durable cutting capacity Constant removal of material and corrosion
F2301/ F2312	Medium A	D0005	D05/DIS	Aluminium Oxide	<ul style="list-style-type: none"> Specially made for stainless steel and aluminium Matt satin finish
F2305	Medium A Heavy Duty	-	-	Aluminium Oxide	<ul style="list-style-type: none"> Works faster with a more coarse finish than F2301 Higher durability with ability to withstand sharp edges Specially engineered to avoid smearing
F2401/ F2412	Fine A	D0097	D97	Aluminium Oxide	<ul style="list-style-type: none"> Fine matt satin finish on stainless steel Defuzzing wood, scuffing paints and varnishes
F2402	Fine A	D0002	D02	Aluminium Oxide	<ul style="list-style-type: none"> Use for all metals Contains anti-smearing resin to reduce rework
F2501/ F2519	Very Fine A	D0091	D91	Aluminium Oxide	<ul style="list-style-type: none"> Finishing all metals Cleaning and removing oxide on soft metals
F4301	Medium S	D0054	D54	Silicon Carbide	<ul style="list-style-type: none"> Semi bright satin finish on stainless steel Surface preparation on aluminium before anodising
F4401	Fine S	D0071	D71	Silicon Carbide	<ul style="list-style-type: none"> For stainless steel, aluminium and brass Weld surface preparation Wood, sanding of primer, scuffing paints and varnishes
F4501	Very Fine S	D0089	D89	Silicon Carbide	<ul style="list-style-type: none"> Semi bright satin finish on aluminium, brass and precious metals Wood, uniform finish, scuffing varnishes
F4601/ F4612	Ultra Fine S	D0098	D98	Silicon Carbide	<ul style="list-style-type: none"> Light cleaning on metals Light finishing on precious metals, scuffing varnishes
F4801	Micro Fine S	D0075	D75	Silicon Carbide	<ul style="list-style-type: none"> Super finishing

BEARTEX FLANGE MOUNTED FLAP WHEELS

MEDIUM DENSITY

- The most conformable of all Beartex wheels. Ideal for use on contoured surfaces & parts with awkward geometry
- Gentle cushioning action achieves a consistent & uniform finish with no risk of gouging
- Suitable for a wide range of applications including corrosion removal, cleaning & surface finishing



FERR. & NON FERR. 

	DIM DxWxB (mm)	GRADE	CAP CODE	PK QTY	ART NO.	PRICE
	150x50x50	Coarse A	F2212	1	66261083026	£000.00
		Medium A	F2312	1	66261082061	£000.00
		Med A Heavy Duty	F2316	1	66261083074	£000.00
		Fine A	F2412	1	66261083078	£000.00
		Very Fine A	F2519	1	66261083082*	£000.00
		Ultra Fine S	F4612	1	66261083084*	£000.00
	200x50x76	Coarse A	F2212	1	66261083027	£000.00
		Medium A	F2301	1	63642588131	£000.00
		Med A Heavy Duty	F2316	1	66261083075	£000.00
		Fine A	F2412	1	66261083079	£000.00
		Very Fine A	F2504	1	63642588137	£000.00
		Very Fine S	F4501	1	63642588145	£000.00

*Made-to-order. More sizes available Made-to-order. Dimensions Key: DIM = Dimensions, DIA = Diameter, W = Width, B = Bore

Refer to accessories section at the back of this catalogue for information on metal bushings. The catalogue includes details of all stock products but other options are available in various sizes, grades & densities using Norton's made to order facility. Please contact your local sales or customer service representative for more information.



RAPID FINISH CONVOLUTE WHEELS FOR BENCH & PEDESTAL GRINDERS

Convolute wheels are formed by wrapping non-woven web material around a centre core and bonding the layers together to create an abrasive wheel. Wheels are available in different diameters, grades and densities for burr, flash and rust removal, reducing surface roughness, blending welds and scratch patterns on stainless steel, polishing welds and applying decorative finishes.

MADE-TO-ORDER SOLUTIONS

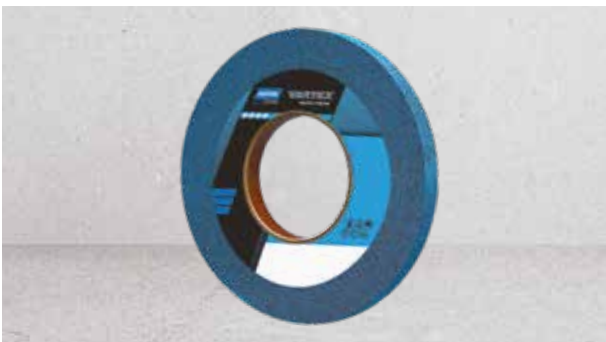

VORTEX RAPID FINISH



- Aggressive, fast-cutting stock removal with excellent form holding
- Proprietary Vortex engineered grain and bond ensures a uniform finish throughout the entire wheel life
- Ideal for deburring, blending and finishing automotive gears and turbine engine components
- Provides a decorative finish on plumbing fixtures and can be used for metal finishing and weld blending during fabrication
- All Vortex convolute wheels are made to order



NEW RAPID FINISH^{GP A/O & S/C}



- For general deburring, blending and finishing on metals, wood and glass
- Clean Bond™ resin technology prevents smearing and loading, even on soft metals
- Wheels have 10%-30% longer life and finish faster thanks to the new grain/bond configuration, reducing the need for wheel changes and increasing productivity
- Wheels can be used wet or dry

CONVOLUTE WHEELS FOR BENCH & PEDESTAL GRINDERS

RAPID FINISH DCS (OPEN MESH)

- Open mesh construction for blending, rust removal and applying decorative contrast finishes in low to moderate speed applications
- Silicon carbide abrasive for fine finishing with light pressure



DxWxB(mm)	GRADE	MCC	PK QTY	ART NO.	PRICE
150x50x25	Fine	C4401	2	63642549645	£000.00
	Medium	C4301	2	66261058510	£000.00

RAPID FINISH DMA RED

- For light deburring, blending & final/decorative finishing
- Generates uniform satin and antique finishes
- Ideal for blending & finishing as well as surface preparation before buffing, polishing and applying decorative finishes



DxWxB (mm)	GRADE	MCC	DENSITY	PK QTY	ART NO.	PRICE
150x25x25	Medium	C2303	5	3	66261007936	£000.00
150x50x25	Medium	C2303	5	2	66261007957	£000.00
200x25x76	Medium	C2303	5	3	66261007831	£000.00
200x50x76	Medium	C2303	5	2	66261007904	£000.00

RAPID FINISH LIGHT FINISHING

- For light deburring, blending, fine finishing and polishing applications
- Ideal for finishing parts with tight tolerances, without altering geometry
- Substantial extended wheel life in a soft, conformable wheel



DxWxB (mm)	REF CODE	ABR TYPE	GRADE	MCC	DENSITY	PK QTY	ART NO.	PRICE
150x25x25	D16	SiC	Fine	C4411	6	3	66254403708	£000.00
	D17	SiC	Fine	C4411	7	3	66254403709*	£000.00
	D18	SiC	Fine	C4411	8	3	66254421573	£000.00
200x25x76	D16	SiC	Fine	C4411	6	3	66261095702	£000.00
	D17	SiC	Fine	C4411	7	3	66254409924	£000.00
	D18	SiC	Fine	C4411	8	3	66254421577	£000.00

Dimensions Key: D = Diameter, W = Width, B = Bore, T = Thickness, S = Spindle

RAPID FINISH SERIES 1000 LONG LIFE

- Ideal for general deburring, blending, finishing and polishing applications
- Starting point for deburring, blending, polishing and finishing applications
- Durable, long life construction with versatile application range, consistent cut rate and shed resistance
- Smear proof & cool cutting on light deburring applications



DxWxB (mm)	REF CODE	ABRASIVE TYPE	GRADE	MCC	DENSITY	PK QTY	ART NO.	PRICE	
150x10x25	D17	SiC	Fine	C4408	7	4	63642549767	€000.00	
150x12x25	D17	SiC	Fine	C4408	7	4	66261018628	€000.00	
	D17	Alox	Medium	C2308	7	4	66261018857	€000.00	
	D17	SiC	Medium	C4408	7	4	69957397880	€000.00	
	D18	SiC	Fine	C4408	8	4	66261018773	€000.00	
	D18	Alox	Medium	C2308	8	4	66261018789	€000.00	
	D19	SiC	Fine	C4408	9	4	66261094584	€000.00	
	150x25x25	D16	Alox	Fine	C2406	6	3	66261055204	€000.00
Alox			Medium	C2308	6	3	66261055205	€000.00	
SiC			Medium	C4308	6	3	66261055202	€000.00	
150x25x25	D17	SiC	Fine	C4408	7	3	66261055223	€000.00	
	D18	SiC	Fine	C4408	8	3	66261018774	€000.00	
	D18	SiC	Medium	C4308	8	3	66261096033	€000.00	
	D19	SiC	Fine	C4408	9	3	07660705227	€000.00	
	D19	SiC	Medium	C4308	9	3	66261055371	€000.00	
150x50x25	D17	Alox	Fine	C2406	7	2	66261008897	€000.00	
200x20x76	D19	SiC	Medium	C4408	9	3	66261023567	€000.00	
200x25x76	D16	SiC	Fine	C4408	6	3	66261019693	€000.00	
			Medium	C4308	6	3	66261055208	€000.00	
	D17	Alox	Fine	C2406	7	3	69957352389	€000.00	
			SiC	Fine	C4408	7	3	66261018639	€000.00
			Alox	Medium	C2308	7	3	66261055232	€000.00
	D18	SiC	Medium	C4308	7	3	69957394610	€000.00	
				C4408	8	8	66261018775	€000.00	
	200x25x76	D18	Alox	Medium	C2308	8	3	66261018855	€000.00
		D18	SiC	Medium	C4308	8	3	66261018673	€000.00
		D19	SiC	Fine	C4408	9	3	66261018641	€000.00
D19		SiC	Medium	C4308	9	3	66261018997	€000.00	
200x50x76	D16	SiC	Medium	C4308	6	2	66261055211	€000.00	
			Alox	Fine	C2406	6	2	66261009252	€000.00
				Fine	C4408	7	2	66261018877	€000.00
	D18	Alox	Medium	C2308	7	2	66261055235	€000.00	
			SiC	Fine	C4408	8	2	66261019629	€000.00
			SiC	Fine	C4408	9	2	66261055276	€000.00
250x12x127	D17	SiC	Fine	C4408	7	4	69957352396	€000.00	
			D18	SiC	Fine	C4408	8	4	66261019221
	Alox	Medium			C2308	8	4	69957352395	€000.00
		SiC			Medium	C4308	8	4	66261019005
	D19	SiC	Fine	C4408	9	4	66261019222	€000.00	
				C4408	9	4	66261019222	€000.00	
250x25x127	D18	Alox	Medium	C2308	8	4	69957352402	€000.00	

CONVOLUTE WHEELS FOR BENCH & PEDESTAL GRINDERS

RAPID FINISH SERIES 4000

- For heavy deburring, edge breaking and removing parting lines on exotic metals
- The product of choice when edge & form holding are of primary importance



DxWxB (mm)	REF CODE	ABRASIVE TYPE	GRADE	MCC	DENSITY	PK QTY	ART NO.	PRICE
150x12x25	D49	SiC	Fine	C4406	9	4	66261004021	£000.00
150x25x25	D48	SiC	Fine	C4406	8	3	66261008658	£000.00
		Alox	Medium	C2306	8	3	66261004208	£000.00
200x25x76	D48	SiC	Fine	C4406	8	3	66261004123	£000.00
		Alox	Medium	C2306	8	3	66261004165	£000.00

BORE HOLE REDUCTION BUSHINGS



WHEEL BORE (mm)	SIZE OF REDUCED BORE WITH BUSHING (mm)	FOR WHEEL DIAMETER (mm)	PK QTY	ART NO.	PRICE
25	10	100 to 150	2	66261080522	£000.00
	13	-	2	66261080523	£000.00
	16	-	2	66261080524	£000.00
	20	-	2	66261080525	£000.00
	22	-	2	66261080526	£000.00
50	13	150 to 200	2	66261082442	£000.00
50	13	150	2	66261080527	£000.00
	16	-	2	66261080528	£000.00
	25	-	2	66261080529	£000.00
	32	-	2	66261080530	£000.00
76	25	200	2	66261080531	£000.00
	32	-	2	66261080532	£000.00
	50	-	2	66261080514	£000.00
125	32	-	2	66261080534	£000.00

Dimensions Key: D = Diameter, W = Width, B = Bore, T = Thickness, S = Spindle

UNDERSTANDING THE PRODUCT

FAMILY NAME	PRODUCT REFERENCE	DENSITY	ABRASIVE TYPE	GRADE	CAP CODE
VORTEX	VTX	7,8,9	Alox	Medium	C2312
GENERAL PURPOSE	GP	5,6,7,8,9	Alox	Medium	C2315
	GP	5,6,7,8,9	Alox	Fine	C2408
	GP	5,6,7,8,9	SiC	Medium	C4315
	GP	5,6,7,8,9	SiC	Fine	C4415
	GP	5,6,7,8,9	SiC	Very fine	C4515
DCS	DCS	4	SiC	Very fine	C4501
	DCS	4	SiC	Fine	C4401
	DCS	4	SiC	Medium	C4301
DSS	DSS	4	SiC	Medium	C4302
DSA	DSA	4	Alox	Medium	C2302
METAL FINISHING	DMA	5	Alox	Medium	C2303
SERIES 1000 LONG LIFE	D1 6 A LL	6,7,8,9	Alox	Medium	C2308
	D1 7 A LL	6,7,8,9	Alox	Medium	C2308
	D1 8 A LL	6,7,8,9	Alox	Medium	C2308
	D1 9 A LL	6,7,8,9	Alox	Medium	C2308
	D1 6 S LL	6,7,8,9	SiC	Fine	C4408
	D1 7 S LL	6,7,8,9	SiC	Fine	C4408
	D1 8 S LL	6,7,8,9	SiC	Medium	C4308
	D1 9 S LL	6,7,8,9	SiC	Medium	C4308
SERIES 4000	D4 8 A	8,9	Alox	Medium	C2306
	D4 8 S	8,9	SiC	Fine	C4406
	D4 9 S	8,9	SiC	Fine	C4406



RAPID STRIP WHEELS FOR DIE GRINDERS

With their thick, strong synthetic fibres, extra coarse silicon carbide abrasive grain and open web construction, Rapid Strip wheels strip and clean fast, don't load or shred and last up to twice as long as other stripping products.

BLAZE RAPID STRIP WHEELS



- The best choice for removal of surface rust & residue, corrosion, light weld splatter, dirt, mill scale & other similar surface contaminants
- Blaze lasts 2x longer than competitor products thanks to the ceramic alumina long-lasting grain

- Leaves a thoroughly cleaned surface for subsequent processes such as coating, painting and soldering
- Extremely versatile; can withstand aggressive use, but soft enough to prevent gouging and rework
- Apply pressure to strip or remove coatings; use lighter pressure to finish like a surface finishing wheel



DxWxB (mm)	CAP CODE	PK QTY	MAX RPM	ART NO.	PRICE
STANDARD					
100x13x12	R9101	25	8000	66623304856	£000.00
150x13x12	R9101	15	8000	66261099378	£000.00
200x13x12	R9102	5	4500	66623393517*	£000.00
SPINDLE MOUNTED WHEELS					
100x13x6	R9101	5	8000	66623378059	£000.00
150x13x8	R9101	10	5500	66623334482	£000.00

Dimensions Key: D = Diameter, W = Width, B = Bore, T = Thickness, S = Spindle

* Made to order

RAPID STRIP

- General purpose wheels for removing coatings such as varnish on wood, metal and plastics
- Nylon fibre, flexible resin and extra coarse grain combine to provide aggressive performance, long life and improved finish
- Leaves a thoroughly cleaned surface, ready for the next stage of the process; coating, painting or soldering
- Will not load on sticky coatings, adhesives, soft metals, will not snag or shed



DxWxB (mm)	CAP CODE	PK QTY	MAX RPM	ART NO.	PRICE
STANDARD					
100x13x12	R4101	25	8000	63642585700	£000.00
150x13x12	R4101	15	5500	63642585703	£000.00
200x13x12	R4101	5	4500	63642585704	£000.00
SPINDLE MOUNTED - STANDARD (1 WHEEL)					
75x13x6	R4101	10	10000	63642557741	£000.00
100x13x6	R4101	10	8000	63642557742	£000.00
150x13x8	R4101	10	6000	63642557743	£000.00
SPINDLE MOUNTED - LARGE AREA (2 WHEELS GANGED)					
75x25x6	R4101	5	10000	63642557744	£000.00
100x25x6	R4101	5	8000	63642557745	£000.00
150x25x8	R4101	5	6000	63642557746	£000.00

MANDRELS STANDARD WHEELS

DISCS DxWxB (mm)	SPINDLE DIA (mm)	PK QTY	ART NO.	PRICE
<150x13x12	6	1	07660707022	£000.00
<200x13x12	8	1	07660707023	£000.00





RAPID BLEND UNITISED WHEELS FOR DIE GRINDERS

Unitised wheels are made from compressed and bonded layers of non-woven abrasive for maintenance operations where an efficient, cost effective solution is needed for deburring, polishing, cleaning and finishing composites. The uniform construction maintains part tolerance and prevents cutting and gauging. Rapid Blend can be used on a variety of shapes and contours, wheels hold their shape well and don't need to be dressed as often. Wheels are also non-metallic so won't contaminate the workpiece.

VORTEX RAPID BLEND CLOSED



- For light weld bead and weld splatter removal, heavy deburring and finishing applications
- Proprietary engineered Vortex aluminum oxide aggregate grain provides aggressive, fast, stock removal, reduced cycle times, and increased part quality
- Reduces heat build up on the workpiece which increases cut rate and helps the disc last up to 2x longer without shredding
- Special resin chemistry makes Vortex Rapid Blend ideal for deburring, even on sharp edges, without shedding or smearing



DxWxB (mm)	CAP CODE	GRADE	PK QTY	RPM	ART NO.	PRICE
STANDARD						
50x6x6	U2305	VOR-7AM	60	22100	66261080270	£000.00
75x3x6	U2305	VOR-5AM	40	18000	66261093448	£000.00
	U2305	VOR-7AM	40	18000	66261191445	£000.00
75x6x6	U2305	VOR-5AM	40	18000	66254414832	£000.00
	U2305	VOR-7AM	40	18000	66261199696	£000.00
75x13x6	U2305	VOR-7AM	20	18000	66261080267	£000.00
125x6x22	U2305	VOR-5AM	20	9000	66254488602	£000.00
150x6x25	U2305	VOR-5AM	8	7500	66254414167	£000.00
	U2305	VOR-7AM	8	7500	66254407225	£000.00
SPINDLE MOUNTED WHEELS						
150x13x8	U2305	3AM	10	8000	66623375067	£000.00

Dimensions Key: D = Diameter, W = Width, B = Bore, T = Thickness, S = Spindle

RAPID BLEND NEX

- Good choice for light deburring and blending
- Can be easily pre-formed for use on a wide variety of shapes/contours
- Imparts a bright finish on stainless steel with improved 2SF and 3SF light/soft density formulation
- Fine silicon carbide & flexible density unitised construction for a smooth controlled blending/finishing experience
- Excellent, consistent, smear-free finish



DxWxB (mm)	CAP CODE	GRADE	PK QTY	RPM	ART NO.	PRICE
50x6x6	U4401	NEX-2SF	20	18000	63642585756	£000.00
	U2401	NEX-4AF	20	22100	63642585755	£000.00
75x3x6	U2301	NEX-8AM	20	18100	63642585831	£000.00
75x6x6	U2301	NEX-2AM	10	12100	63642585763*	£000.00
	U4401	NEX-2SF	10	12100	63642585768	£000.00
	U4401	NEX-3SF	10	12100	63642571113	£000.00
	U2401	NEX-6AF	10	18100	63642585771	£000.00
	U2301	NEX-6AM	10	18100	66261081929*	£000.00
	U2301	NEX-8AM	10	18100	63642585774	£000.00
	125x6x22	U4401	NEX-2SF	20	6000	66254488603
	U4401	NEX-3SF	20	6000	66254489419	£000.00
150x6x13	U2301	NEX-2AM	10	4500	66261019412	£000.00
	U4401	NEX-2SF	10	5000	66261019416	£000.00
	U4401	NEX-3SF	8	5000	66261016691	£000.00
	U2301	NEX-6AM	10	7500	66261019414	£000.00
150x6x25	U4401	NEX-2SF	8	7500	66261017050	£000.00
	U4401	NEX-3SF	8	7500	66254489421	£000.00
150x13x13	U2301	NEX-2AM	5	4500	63642585818	£000.00
	U4401	NEX-2SF	5	5000	63642585812	£000.00
	U4401	NEX-3SF	4	5000	66261015826	£000.00
	U2401	NEX-4AF	5	7500	63642585815	£000.00
	U2301	NEX-8AM	5	7500	63642585824	£000.00
150x25x13	U2301	NEX-2AM	5	4500	69957350267	£000.00
	U4401	NEX-2SF	5	5000	69957350272	£000.00
	U2401	NEX-4AF	5	7500	69957350269	£000.00
150x25x25	U2301	NEX-2AM	5	4500	63642585789*	£000.00
	U4401	NEX-2SF	5	5000	63642585795	£000.00
	U2401	NEX-4AF	5	7500	63642585792	£000.00
200x25x25	U2301	NEX-2AM	5	3500	63642585796	£000.00
	U4401	NEX-2SF	5	4000	63642585797	£000.00

* Made to order

SMALL UNITISED WHEELS / BOBS



DxWxB (mm)	CAP CODE	GRADE	PK QTY	ART NO.	PRICE
25x25x5	U4401	NEX 2SF	50	66261014883	£000.00
25x25x5	U2301	NEX 6AM	50	66261014908	£000.00
Use with threaded mandrel	-	-	1	66261077832	£000.00

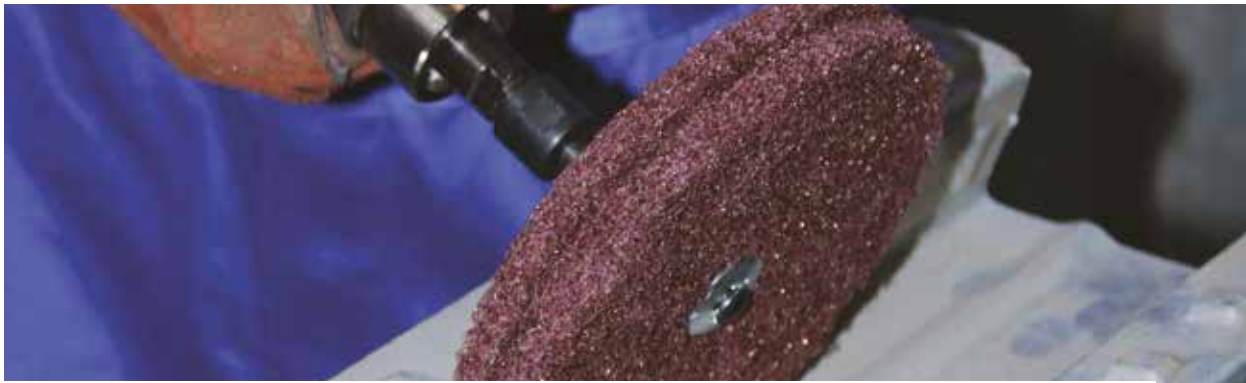

HIGH STRENGTH DISCS FOR DIE GRINDERS

Made of a strong nylon web impregnated with abrasive grain and resin, Beartex high strength discs are designed for demanding applications on a wide range of materials. A general purpose product which produces a light satin finish.

Applications include rust/oxide or coating removal, pipe ID and OD polishing, casting cleaning, highlighting (antiquing), contaminant removal, removal of handling marks, gasket removal, cleaning and blending of surface imperfections, prepping prior to soldering, removal of filling materials, cleaning angles and odd shapes. Will not stretch or shed. Ganging increases versatility.

BEARTEX HIGH STRENGTH DISCS

- The new, improved specification means discs last longer and have better resistance to tearing when used on burrs and sharp edges
- Can be combined with multiple wheels to form a very flexible, durable wheel for use on bench or straight grinders
- Strong, smear-proof resin binders help produce light satin finishes
- Different sizes are available for mounting on bench grinders or portable die grinders using a mandrel



DxB (mm)	CAP CODE	GRADE	PK QTY	ART NO.	PRICE
100x8	F2303	Medium	10	66254429562	£000.00
150x12	F2303	Medium	10	77696087534	£000.00
	F2506	Very fine	10	77696087535	£000.00
200x12	F2303	Medium	10	77696087536	£000.00
	F2506	Very fine	10	77696087537	£000.00

BEARTEX LAP MOPS

- Ideal for hard to reach areas and intricate shaped components
- Use with a mandrel



D (mm)	CAP CODE	GRADE	PK QTY	MAX RPM	ART NO.	PRICE
150	F2520	Very fine	5	4000	07660707529*	£000.00
150	F2303 High strength	Medium	5	4000	63642573074	£000.00
150	F2316 Heavy duty	Medium	5	4000	63642573587	£000.00

Dimensions Key: D = Diameter, W = Width, B = Bore, T = Thickness, S = Spindle



HIGH-STRENGTH CROSS BUFFS

- Ideal for use on internal pipes and tubes
- For quick deburring and cleaning

DxT (mm)	GRADE	PK QTY	MAX RPM	ART NO.	PRICE
38x13	Medium	100	18000-23000	08834189308*	€000.00
38x13	Very fine	100	18000-23000	08834189307*	€000.00
Mandrel MM32-4**	-	1	18000-23000	63642587136*	€000.00



** Use Mandrel MM32-4 to mount 38mm Cross Buffs

MANDRELS FOR DIE GRINDERS

	LxSxW (mm)	FOR USE WITH WHEEL DIA (mm)	MAX USABLE WHEEL WIDTH (mm)	BORE HOLE DIA (mm)	PK QTY	ART NO.	PRICE
MANDRELS WITH WASHERS							
RapidStrip/Plain discs	55x6x40	Up to 150	13	10 to 12	1	07660707022	€000.00
RapidStrip/Plain discs/large dia Unitised wheels >150mm	55x8x38	Up to 200	13	10 to 13	1	07660707023	€000.00
MANDRELS							
Unitised wheels	60x6	Up to 75	6	6 & 10	1	63642586234	€000.00
Unitised wheels	75x6	Up to 75	6 to 12	6 & 10	1	63642586236	€000.00
Unitised wheels	85x6	Up to 150	12 to 25	6	1	63642586239	€000.00
THREADED MANDREL							
Unitised wheels/bobs	25x6	25	25	5	1	66261077832	€000.00



MANDRELS WITH WASHERS



MANDRELS



THREADED MANDREL

Dimensions Key: L = Length, W = Width, B = Bore, S = Spindle



NORTON

SAINT-GOBAIN®

COATED

ROLLS

Handy rolls
Paper & cloth rolls
Norton meshpower

144 Beartex rolls
148 Rotolo Foam rolls
153

154
156

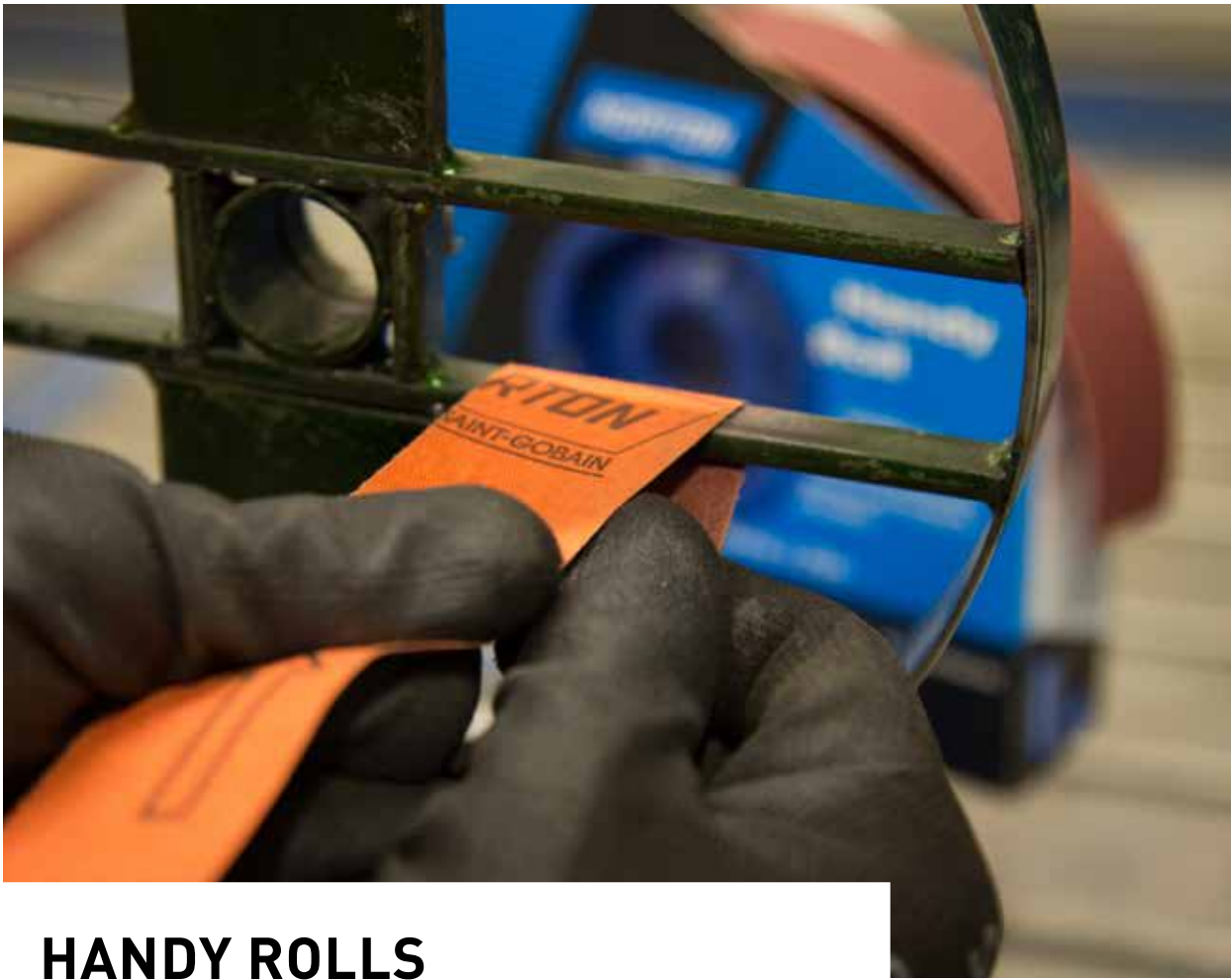

HANDY ROLLS

Engineered for flexibility and fast cutting, cloth handy rolls tear cleanly and straight without shedding and are packed in a protective dispenser to eliminate waste and damage.

PRODUCT SELECTION GUIDE

Highly recommended ●
Recommended ◐
Suitable ○



MATERIALS / APPLICATIONS	R222	F2316	K20N
	+++++	++++	+++
General purpose (metal, wood, etc.)	●	◐	○
Scouring and light deburring,	●	●	◐
Scale and rust removal,	◐	◐	●
Blending and fine sanding,	◐	●	◐
Polishing lathe turnings, rolls and cylinders, and blending machine tool marks	◐	●	○



R222 handy rolls are designed for manual applications. The high flexibility of the cloth in combination with the wide grit range, from coarse to fine, provides an excellent tool for a variety of applications including deburring, rust removal & finishing metal.

R222 **+++++**

- Versatile aluminium oxide abrasive for hand sanding of wood & metal
- For general purpose maintenance applications offers extra durability and even wear
- Flexible cotton backing ideal for sanding profiled surfaces & round steel parts
- Dispenser unit for easy storage and product protection



FERR. & NON FERR. HARD & SOFT WOOD



DIM WxL (mm/m)	GRIT	PK QTY	ART NO.	PRICE
25mmx25m	40	1	63642531849	£000.00
	50	1	63642531850	£000.00
	60	1	63642531823	£000.00
	80	1	63642531820	£000.00
	100	1	63642531815	£000.00
	120	1	63642531811	£000.00
	150	1	63642531808	£000.00
	180	1	63642531805	£000.00
	220	1	63642531802	£000.00
	240	1	63642531799	£000.00
	320	1	63642531796	£000.00
	400	1	63642531793	£000.00
38mmx25m	600	1	63642560206	£000.00
	40	1	63642531828	£000.00
	50	1	63642531826	£000.00
	60	1	63642531824	£000.00
	80	1	63642531821	£000.00
	100	1	63642531817	£000.00
	120	1	63642531812	£000.00
	150	1	63642531809	£000.00
	180	1	63642531806	£000.00
	220	1	63642531803	£000.00
	240	1	63642531800	£000.00
	280	1	63642536425	£000.00
320	1	63642531797	£000.00	
400	1	63642531794	£000.00	
600	1	63642539150	£000.00	
50mmx25m	40	1	63642531829	£000.00
	50	1	63642531827	£000.00
	60	1	63642531825	£000.00
	80	1	63642534758	£000.00
	100	1	63642531818	£000.00
	120	1	63642531814	£000.00
	150	1	63642531810	£000.00
	180	1	63642531807	£000.00
	220	1	63642531804	£000.00
	240	1	63642531801	£000.00
	280	1	63642536426	£000.00
	320	1	63642531798	£000.00
400	1	63642531795	£000.00	
600	1	63642534757	£000.00	

Dimensions Key: DIM = Dimensions, W = Width, L = Length



NEW K20N +++
THE AFFORDABLE CONSUMABLE FOR EVERYDAY USE

- Aluminium oxide grain for fast cut, good material removal and excellent price/performance ratio
- Good choice for small-volume metal and woodworking applications
- Superior conformability to flat and complex surfaces and better finishes
- Dispenser unit for easy storage and product protection



FERR.
& NON FERR.



HARD &
SOFT WOOD



	DIM WxL	GRIT	PK QTY	ART NO.	PRICE		
	25mm x 25m	40	1	69957316141	£000.00		
		50	1	69957316143	£000.00		
		60	1	69957316144	£000.00		
		80	1	69957316146	£000.00		
		100	1	69957316147	£000.00		
		120	1	69957316148	£000.00		
		150	1	69957316149	£000.00		
		180	1	69957316151	£000.00		
		220	1	69957316152	£000.00		
		240	1	69957316153	£000.00		
			38mm x 25m	40	1	69957393819	£000.00
				50	1	69957375534	£000.00
60	1			69957377802	£000.00		
80	1			69957374796	£000.00		
100	1			69957375075	£000.00		
120	1			69957375074	£000.00		
150	1			66261159485	£000.00		
180	1			69957393824	£000.00		
220	1			69957375532	£000.00		
240	1			66261153914	£000.00		

Dimensions Key: DIM = Dimensions, W = Width, L = Length

DIM WxL	GRIT	PK QTY	ART NO.	PRICE
50mm x 25m	40	1	69957378214	£000.00
	50	1	69957372295	£000.00
	60	1	69957373478	£000.00
	80	1	69957375076	£000.00
	100	1	69957374797	£000.00
	120	1	69957393823	£000.00
	150	1	69957377808	£000.00
	180	1	66261153913	£000.00
	220	1	69957377801	£000.00
	240	1	69957375077	£000.00

NEW NON-WOVEN F2316

- Flexible 3D handpad material in roll form for hand and machine use
- Complementary to R222 and K20N handy rolls, for finishing
- Premium aluminum oxide grain gives a performance boost, cleaning, blending deburring and finishing in record time
- Ideal to access awkward corners and recesses



DIM WxL (mm/m)	GRADE	CAP CODE	PK QTY	ART NO.	PRICE
38mm x 5m	F2316 Heavy Duty MED A	F2316	1	66261129709	£000.00



PAPER & CLOTH ROLLS

Coated abrasive rolls are ideal for fast easy sanding, light deburring and polishing of wood, paint, metal and plaster, rust and scale. They can be torn to exact lengths as needed.

PRODUCT SELECTION GUIDE

Highly recommended ●
Recommended ◐
Suitable ○





	R222 Flexible J-weight cotton cloth	NEW K20N J-weight cotton cloth	H231 Strong F-Weight paper	A275 Fibre-reinforced latex, B-weight paper	G131F E-weight backing
MATERIALS / APPLICATIONS	+++++	+++	+++++	++++	+++
Metal	●	○	◐		
Wood			●	◐	○
Primer / paint / varnish			◐	●	○

H231 **+++++**

- Aluminium oxide grain for long life
- Open grain distribution and anti-static properties helps reducing clogging
- Premium product for all types of wood and also suitable for surface finishing on metal
- Minimise dust when used with an appropriate extraction system



DIM WxL (mm/m)	GRIT	PK QTY	ART NO.	PRICE	
	120mm x 50m	60	1	63642539189	£000.00
		80	1	63642539187	£000.00
		120	1	63642539183	£000.00
		150	1	63642539181	£000.00
		180	1	63642546049	£000.00



Grinding non-conductive materials, such as wood, creates electrical charges in the abrasive that causes adhesion of the grinding dust to the abrasive. The anti-static properties of H231 ground the electrical charge through the coated abrasive and the machine preventing this adhesion, reducing clogging and longer product life.

NORTON PRO A275 **+++**

- Premium heat-treated aluminium oxide abrasive blend for long life and fast cut rate
- Suitable for use on primer, paint filler & coating sanding (for automotive & transport applications) and wood
- Tear resistant fibre-reinforced latex for wet or dry sanding
- No-Fil® anti-loading third layer for better finish, loading resistance & extended life



DIM WxL (mm/m)	GRIT	PK QTY	ART NO.	PRICE	
	100mm x 50m	80	2	63642591122	£000.00
		120	2	63642591123	£000.00
		150	2	69957391073	£000.00
		180	2	63642591124	£000.00
		220	2	63642590924	£000.00
		240	2	63642590927	£000.00
		320	2	63642591649	£000.00
115mm x 50m	80	2	69957380739	£000.00	
	120	2	69957380761	£000.00	
	150	2	69957380765	£000.00	
	180	2	69957380767	£000.00	
	220	2	69957380769	£000.00	
	240	2	69957380777	£000.00	
	280	2	69957380778	£000.00	
	320	2	69957380779	£000.00	
	400	2	69957380781	£000.00	
	500	2	69957396696	£000.00	

G131F **+++**

- Aluminium oxide grain for fast cut, good material removal and excellent price/performance ratio
- Versatile product for wood and plaster sanding
- Responsibly sourced, made with FSC mix certified paper backing
- Wide make to order availability



PAINT/VARN, PLASTER & FILLER, HARD WOOD & SOFT WOOD



	DIM WxL (mm/m)	GRIT	PK QTY	ART NO.	PRICE
	93mm x 50m	80	2	66623372548	£000.00
		100	2	66623372549	£000.00
		120	2	66623372550	£000.00
	100mm x 50m	40	2	66623372536	£000.00
		60	2	66623372537	£000.00
		80	2	66623372538	£000.00
		100	2	66623372539	£000.00
		120	2	66623372540	£000.00
		150	2	66623372555	£000.00
115mm x 50m	40	2	66623372551	£000.00	
	60	2	66623372204	£000.00	
	80	2	66623372535	£000.00	
	100	2	66623372552	£000.00	
	120	2	66623372545	£000.00	
	150	2	66623372205	£000.00	
	180	2	66623372558	£000.00	
120mm x 50m	220	2	66623372554	£000.00	
	40	2	66623372542	£000.00	
	60	2	66623372543	£000.00	
	80	2	66623372553	£000.00	
	100	2	66623372541	£000.00	
	120	2	66623372544	£000.00	
		150	2	66623372556	£000.00
		180	2	66623372559	£000.00



Dimensions Key: DIM = Dimensions, W = Width, L = Length



FSC® CERTIFICATION

Utilizing responsibly sourced material and preserving natural resources is a high priority, look out for the FSC® logo next to products manufactured using FSC® certified paper.

The mark of responsible forestry

R222 **+++++**

- Versatile aluminium oxide abrasive for hand sanding and handheld machine sanding
- For general purpose maintenance applications, offers extra durability and even wear
- Flexible cotton backing ideal for sanding profiled surfaces & round steel parts
- Long life in wood & metal applications



DIM WxL (mm/m)	GRIT	PK QTY	ART NO.	PRICE	
	50mm x 50m	40	5	63642512909	£000.00
		60	5	63642540086	£000.00
		80	5	63642539135	£000.00
		100	5	63642539136	£000.00
		120	5	63642559727	£000.00
		150	5	63642539208	£000.00
		180	5	63642539137	£000.00
		220	5	63642512916	£000.00
		240	5	63642512917	£000.00
		320	5	63642512918	£000.00
		400	5	63642512919	£000.00
	100mm x 50m	40	1	63642536559	£000.00
60		1	63642560979	£000.00	
80		1	63642531852	£000.00	
100		1	63642531854	£000.00	
120		1	63642531855	£000.00	
150		1	63642545861	£000.00	
180		1	63642531856	£000.00	
240		1	63642531857	£000.00	
320		1	63642545865	£000.00	
400		1	63642545867	£000.00	
430mm x 50m	60	1	63642539142	£000.00	
	80	1	63642539143	£000.00	
	120	1	63642539145	£000.00	
	150	1	63642539146	£000.00	
	180	1	63642539147	£000.00	

CLOTH ROLLS

NEW K20N

- Aluminium oxide grain for fast cut, good material removal and excellent price/performance ratio
- Ideal for general purpose maintenance applications



FERR. & NON FERR.



HARD & SOFT WOOD



	DIM WxL (mm/m)	GRIT	PK QTY	ART NO.	PRICE	
	50mm x 50m	40	5	69957376895	£000.00	
		60	5	69957380137	£000.00	
		80	5	69957377805	£000.00	
		100	5	69957376896	£000.00	
		120	5	69957372227	£000.00	
		150	5	69957377807	£000.00	
		180	5	69957378218	£000.00	
		220	5	69957380131	£000.00	
		240	5	69957377806	£000.00	
		100mm x 50m	40	1	69957375533	£000.00
			60	1	69957375535	£000.00
			80	1	69957375536	£000.00
100	1		69957375528	£000.00		
120	1		69957375529	£000.00		
150	1		69957375530	£000.00		
180	1		69957375531	£000.00		
240	1		69957380132	£000.00		
120mm x 25m	40	1	69957374543	£000.00		
	60	1	66261060811	£000.00		
	80	1	69957374544	£000.00		
	120	1	69957374546	£000.00		
	180	1	66261060812	£000.00		

Dimensions Key: DIM = Dimensions, W = Width, L = Length

MADE-TO-ORDER PRODUCT AVAILABILITY

PRODUCT	BACKING	24	36	40	60	80	100	120	150	180	220	240	280	320	400	600	800
R222	Flexible J-weight cotton cloth		•	•	•	•	•	•	•	•	•	•	•	•	•	•	
R309*	Super flexible cotton cloth				•	•	•	•	•	•	•	•	•	•	•		
H231	Strong F-Weight paper		•	•	•	•	•	•	•	•	•	•	•	•	•		
R817*	Heavy polyester cloth	•	•	•	•	•	•										
A275	Fibre-reinforced latex, B-weight paper					•	•	•	•	•	•	•	•	•	•	•	•
K20N	J-weight cotton cloth			•	•	•	•	•	•	•	•	•					
G131F	E-weight backing			•	•	•	•	•	•	•	•						

*Made to order

MINIMUM ORDER QUANTITIES FOR MADE TO ORDER ITEMS (50m LONG)

DIMENSIONS (mm)	MINIMUM ORDER QUANTITY
Up to 25mm	20 pieces
26 up to 50mm	12 pieces
51 up to 100mm	4 pieces
101 up to 200mm	2 pieces
Over 201mm	1 piece



NORTON MESHPOWER ROLLS

Norton MeshPower is a multifunctional abrasive, designed with thousands of holes, created by the unique mesh matrix structure. This hole structure allows dust extraction in any application.

- Mesh backing enables excellent dust extraction, for a cleaner working environment and less clean up time
- No-fil® technology prevents clogging for longer product life
- Can be used wet or dry
- Self-grip backing for a quick and easy change
- Can be used on many materials, flat and contoured surfaces, by hand or machine
- No defined hole pattern for fast, easy alignment with the back-up pad
- Easy to identify product type by grain colour

NEW MESHPOWER ROLLS CERAMIC **+++++**

	DIMENSIONS	GRIT	PK QTY	ART NO.	PRICE
	75 x 10 m	80	1	69957326171	£000.00
		120	1	69957326176	£000.00
		180	1	69957326178	£000.00
		240	1	69957326179	£000.00
		320	1	69957326182	£000.00
	115 x 10m	80	1	69957326269	£000.00
		120	1	69957326270	£000.00
		180	1	69957326271	£000.00
		240	1	69957326272	£000.00
		320	1	69957326273	£000.00



CERAMIC ADVANTAGE

Ceramic grain provides the ultimate material removal, best productivity, longest life and finest finish.



BEARTEX ROLLS

Beartex non-woven rolls are ideal for a broad range of applications from cleaning and finishing to deburring and light polishing operations. The flexibility of Beartex products ensures constant contact with the surface and prevents cutting or gouging when working.

Rolls can be cut to the required size and folded to suit any application.

BEARTEX SLIT ROLLS

- Flexible 3D handpad material in roll form for for hand and machine use
- Conforms to contours of work surface and provides a uniform finish
- Long life with resilient construction
- Ideal for blending and finishing applications on a variety of substrates

	DIM WxL (mm x m)	GRADE	CAP CODE	PK QTY	ART NO.	PRICE
	100mm x 10m	Medium A	F2300	2	63642557499	£000.00
		NEW Heavy Duty MED A	F2316	2	66261106168	£000.00
		Fine A	F2401	2	66261018300	£000.00
		Very Fine A	F2560	2	63642557738	£000.00
		Very Fine A Long Life	F2504	2	66261018301	£000.00
		Micro Fine A	F2801	2	63642557500	£000.00
		Ultra Fine S	F4660	2	63642557501	£000.00
115mm x 10m	Very Fine A	F2560	2	63642557739	£000.00	
	Very Fine A Long Life	F2504	2	63642587694	£000.00	
	Ultra Fine S	F4660	2	63642557503	£000.00	
120mm x 10m	General Purpose	F2568	2	63642515571	£000.00	



DIM WxL (mm x m)	GRADE	CAP CODE	PK QTY	ART NO.	PRICE
125mm x 10m	Medium A	F2300	2	63642557504	£000.00
	Fine A	F2401	2	66261018307	£000.00
	Very Fine A	F2560	2	63642557740	£000.00
	Very Fine A Long Life	F2504	2	66261018308	£000.00
	Micro Fine A	F2801	2	63642557505*	£000.00
	Ultra Fine S	F4660	2	63642557506	£000.00
150mm x 10m	Medium A	F2300	2	63642557507	£000.00
	NEW Heavy Duty MED A	F2316	2	66261106011	£000.00
	Very Fine A	F2504	2	66261018312	£000.00
	Ultra Fine S	F4660	2	63642557508*	£000.00

*Made to order

BEARTEX ROTOLO ROLLS PRE-CUT

- Ideal storage and space saver with self dispensing function
- Rotolo rolls precut every 150mm for easy pad size use
- Thinner web (Thinflex version) cuts faster, saves time, with no added effort from the user. Product can be scrunched, rolled and saves shelf space



DIM WxL (mm x m)	GRADE	CAP CODE	PK QTY	ART NO.	PRICE
BEARTEX					
115mm x 10m	Very Fine A	F2504	1	77696009598	£000.00
	Ultra Fine S	F4807	1	77696042071	£000.00
	NEW Micro Fine A	F2802	1	66261124481	£000.00
	NEW White	F0001	1	66261124480	£000.00
THINFLEX					
115mm x 10m	Very Fine A	F2504	1	77696042073	£000.00
	Ultra Fine S	F4807	1	77696042075	£000.00

Dimensions Key: DIM = Dimensions, DIA = Diameter, W = Width





ROTOLO FOAM ROLLS

The special flexible and conforming foam backing allows a very good distribution of sanding pressure preventing over sanding and are ideal for fine sanding on round edges, contours & curves, providing an outstanding finish on primers & top coats. Rotolo Foam rolls are pre-perforated for easy handling by tearing cut sheets out of dispenser box.

PRODUCT SELECTION GUIDE

Highly recommended ●

Recommended ◐



MATERIALS	NORTON PRO	
	A275	A296
	++++	+++
Metal - fine sanding	●	◐
Wood - fine sanding	●	◐
Filler	●	◐
Varnish / paint / primer	●	◐
Composites /coatings	●	◐

NORTON PRO A275

- Premium Aluminum oxide foam rolls are water-resistant, for dry or wet sanding. Washable
- 25m long roll of pre-cut sheets, easy to use and economic
- Excellent for fine sanding with high finishing level
- Ideal for use on round edges, contours and curves without breaking through the paint surface



DIM WxL (mm x m)	GRIT	COLOUR	PK QTY	ART NO.	PRICE	
	115mm x 25m	120	Apple Green	2	63642535316	£000.00
	150	Orange	2	63642557584	£000.00	
	180	Purple	2	63642557599	£000.00	
	220	Red	2	63642557600	£000.00	
	240	Electric Blue	2	63642557602	£000.00	
	280	Grey	2	63642557604	£000.00	
	320	Salmon	2	63642557606	£000.00	
	360	Pink	2	63642557607	£000.00	
	400	Yellow	2	63642557608	£000.00	
	500	Dark Blue	2	63642557611	£000.00	
	600	Fuchsia	2	63642557612	£000.00	
	800	Turquoise	2	63642557613	£000.00	
	1000	White	2	63642557616	£000.00	
	1500	Green	2	63642557617	£000.00	

GOLD RESERVE A296

- Tough aluminium oxide grain produces a quick and cool cut
- Strong B weight latex / paper backing resists tearing
- Conformable and flexible
- Water-based, non-loading stearate, resists loading



DIM WxL (mm x m)	GRIT	PK QTY	ART NO.	PRICE	
	115mm x 25m	240	2	66261097596	£000.00
	280	2	66261097597	£000.00	
	320	2	66261097598	£000.00	
	400	2	66261097599	£000.00	
	500	2	66261097600	£000.00	
	600	2	66261097601	£000.00	
	800	2	66261097602	£000.00	

See the Norton Automotive Aftermarket catalogue for extended offer of A296 Rotolo Foam rolls

Dimensions Key: DIM = Dimensions, W = Width, L = Length



Box labels are colour coded by grit size for easy product recognition. The colour-coding follows the Norton Pro grit colour-coding system



NORTON

SAINT-GOBAIN®

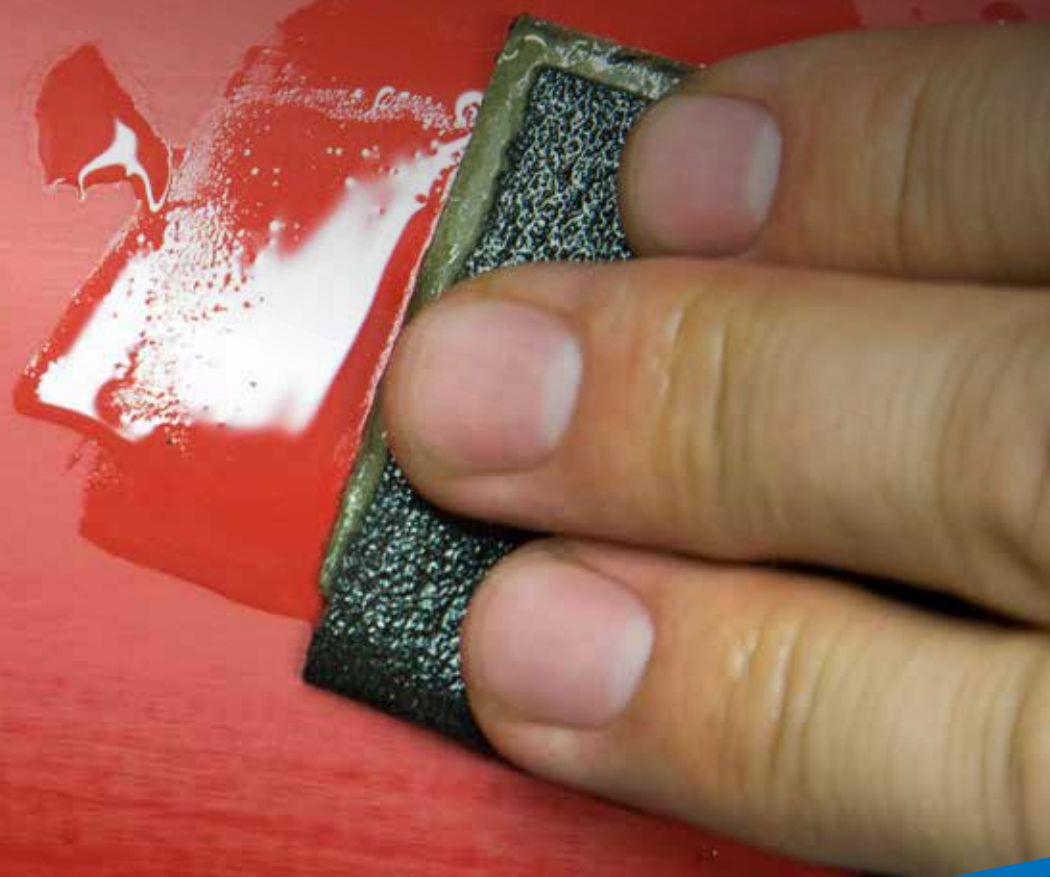

COATED

SHEETS & SPONGES

Cut sheets
Sheets & hand pads

160
163

Norton Meshpower
Beartex sheets & hand pads
Abrasive sponges

167
169
171



CUT SHEETS FOR SANDING BLOCKS

Norton offers a full range of cut sheets for hand and machine use, providing a range of efficient, user-friendly abrasive solutions. The extended range of dimensions and grits complies with all commonly encountered applications.

PRODUCT SELECTION GUIDE CUT SHEETS

Highly recommended ●

Recommended ◐

Suitable ○

MATERIAL	APPLICATION	NORTON PRO PLUS A975	NORTON PRO A275	G131F
		+++++	++++	+++
Metal	Coarse sanding			◐
	Finishing			◐
Hard Wood	Coarse sanding		○	◐
	Finishing	●	◐	◐
Soft Wood	Coarse sanding		◐	◐
	Finishing	●	◐	◐
Filler	Aluminium/Metal	◐	◐	○
	Polyester	●		○
Varnish / Paint / Primer	Coarse sanding		●	○
	Finishing	●	◐	○
Composites / Coatings	Sanding	●	◐	○
	Finishing	●	◐	○
Plaster	Coarse sanding			●
	Finishing		●	◐

*Made to order

HOLE PATTERNS FOR CUT SHEETS

Norton offers a range of cut sheets with different hole patterns for dust extraction.

Other hole patterns available on request.



80 × 133mm
8 holes ø 10mm



115 × 280mm
with no holes

NORTON PRO PLUS A975

- Norton SG ceramic grain blended with heat treated aluminium oxide abrasive for the highest cut rate
- Extra durability and even wear, ideal for large surface areas
- Higher & faster cut rate with uniform scratch pattern
- Resists clogging during use thanks to the No-Fil® steerate layer



	DIM WxL (mm)	GRIT	PK QTY	ART NO.	PRICE
		80	25	66261087406	£000.00
		120	25	66261087411	£000.00
		180	25	66261187577	£000.00
		240	25	66254478608	£000.00
		320	25	66254478614	£000.00

NORTON PRO A275

- Premium, heat-treated aluminium oxide abrasive for fast cut rate and improved performance
- The water based No-Fil® resists loading
- Universal cut sheet for multiple applications
- Unique fibre-reinforced latex paper for additional flexibility & tear resistance



	DIM WxL (mm)	GRIT	PK QTY	ART NO.	PRICE
		80	50	63642588214	£000.00
		120	50	63642588217	£000.00
		180	50	63642588221	£000.00
		240	50	63642588223	£000.00
		280	50	63642588224	£000.00
		320	50	63642588225	£000.00
		400	50	63642588226	£000.00

Dimensions Key: DIM = Dimensions, W = Width, L = Length

G131F

- Aluminium oxide grain for fast cut, good material removal and excellent price/performance ratio
- Versatile product for wood and plaster sanding
- Made with FSC mix certified paper backing
- Wide make to order availability



	DIM W x L (mm)	GRIT	PK QTY	ART NO.	PRICE
		40	50	66623372533	£000.00
		80	50	66623372576	£000.00
		120	50	66623372581	£000.00
		180	50	66623372579	£000.00

Dimensions Key: DIM = Dimensions, W = Width, L = Length

SEE THE NORTON AUTOMOTIVE AFTERMARKET CATALOGUE FOR **A975 & H835 MULTIAIR CUT SHEETS**

Other sizes available on request.

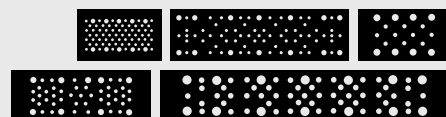

CUT SHEETS FOR SANDING BLOCKS

MADE-TO-ORDER PRODUCT AVAILABILITY

PRODUCT / GRIT	36	40	60	80	120	150	180	220	240	280	320	400	500	600	800
NORTON PRO PLUS A975				•	•	•	•	•	•	•	•	•	•	•	•
BLUE FIRE NORZON H835F*		•	•	•	•		•								
NORTON PRO A275				•	•	•	•	•	•	•	•	•	•	•	•
H231*	•	•	•	•	•	•	•		•		•				
G131F		•	•	•	•	•	•								

• Available as make to order

HOLE PATTERNS FOR CUT SHEETS AVAILABLE AS MTO

Other sizes and hole patterns available on request



115 x 280mm
14 holes ø 10mm



93 x 180mm
8 holes ø 10mm



93 x 230mm
8 holes ø 10mm

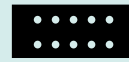

115 x 230mm
10 holes ø 10mm



115 x 280mm
10 holes ø 10mm



Delta 98 x 148 mm
7 holes ø 10 mm



Delta ø 96 mm
6 holes ø 8 mm
on hole circle ø 52 mm

MINIMUM ORDER QUANTITY

DIAMETER (mm)	MINIMUM ORDER QUANTITY
80 x 133	1000 pieces
93 x 180	1000 pieces
93 x 230	1000 pieces
115 x 230	1000 pieces
115 x 280	1000 pieces
Delta 96mm	2000 pieces
Delta 98 x 148	1000 pieces



FSC® CERTIFICATION

Utilizing responsibly sourced material and preserving natural resources is a high priority, look out for the FSC® logo next to products manufactured using FSC® certified paper.



SHEETS & HAND PADS FOR HAND SANDING

Norton offers a comprehensive range of paper, cloth & waterproof sheets for manual applications, used in all commonly encountered industrial applications.

PRODUCT SELECTION GUIDE

Highly recommended ●
Recommended ◐



MATERIAL	APPLICATION	R222 CLOTH SHEETS	NEW K20N CLOTH SHEETS	NORTON PRO A275 PAPER SHEETS	T489 WATERPROOF SHEETS	T100 WATERPROOF SHEETS
		+++++	+++	++++	++++	+++
Metal	Wet sanding				●	◐
	Dry sanding	●	◐			
Hard wood	Coarse sanding	●	◐			
	Light sanding & finishing			●		
Varnish / paint / primer	Wet sanding				●	◐
	Dry sanding			●		

More products available in the Norton Automotive Aftermarket catalogue

SHEETS & HAND PADS FOR HAND SANDING

R222 CLOTH SHEETS **++++**



- Aluminium oxide abrasive
- Highly flexible J-weight cloth backing for use on curves and contours
- High quality universal product
- Tears cleanly and easily

FERR. & NON FERR.



PAINT/VARN, PLASTER & FILLER, HARD WOOD & SOFT WOOD



	DIM WxL (mm)	GRIT	PK QTY	ART NO.	PRICE	
		230 x 280	40	25	63642531776	£000.00
		50	25	63642531777	£000.00	
		60	25	63642531778	£000.00	
		80	50	63642531779	£000.00	
		100	50	63642531780	£000.00	
		120	50	63642531781	£000.00	
		150	50	63642531782	£000.00	
		180	50	63642531783	£000.00	
		220	50	63642531785	£000.00	
		240	50	63642531786	£000.00	
		280	50	63642531788	£000.00	
		320	50	63642531789	£000.00	
		400	50	63642531790	£000.00	
		600	50	63642534613	£000.00	

NEW K20N CLOTH SHEETS **+++**



- Aluminium oxide abrasive for aggressive cutting action on all dry sanding applications
- Heavy & light duty hand sanding depending on grit
- For use on wood and metal (rust removal to light finishing)
- Excellent price / performance ratio

FERR. & NON FERR.



PAINT/VARN, PLASTER & FILLER, HARD WOOD & SOFT WOOD



	DIM WxL (mm)	GRIT	PK QTY	ART NO.	PRICE	
		230 x 280	40	50	69957307652	£000.00
		60	50	69957307653	£000.00	
		80	50	69957307655	£000.00	
		100	50	69957307659	£000.00	
		120	50	69957307661	£000.00	
		150	50	69957307663	£000.00	
		180	50	69957307668	£000.00	
		220	50	69957307669	£000.00	
		240	50	69957307671	£000.00	

Dimensions Key: DIM = Dimensions, W = Width, L = Length

NORTON PRO A275 PAPER SHEETS

- Premium, aluminium oxide abrasive for fast cut rate and improved performance
- The water based No-Fil® improves resistance to clogging
- Faster cut rate and longer life
- Unique fibre-reinforced latex paper for additional flexibility & tear resistance

PAINT/VARN, PLASTER & FILLER, HARD WOOD & SOFT WOOD

	DIM WxL (mm)	GRIT	PK QTY	ART NO.	PRICE	
		230 x 280	80	50	63642558015	£000.00
		100	50	63642585256	£000.00	
		120	100	63642558016	£000.00	
		150	100	63642586145	£000.00	
		180	100	63642558017	£000.00	
		220	100	63642586139	£000.00	
		240	100	63642558018	£000.00	
		280	100	63642585742	£000.00	
		320	100	63642586132	£000.00	
		360	100	63642586133	£000.00	
		400	100	63642586134	£000.00	
		500	100	63642586136	£000.00	
		600	100	63642586137	£000.00	
		800	100	63642586138	£000.00	

Dimensions Key: DIM = Dimensions, W = Width, L = Length

T489 WATERPROOF SHEETS

- Extremely sharp Silicon carbide grain for hard and tough surfaces
- Flexible backing for improved conformability to workpiece
- For use on lacquer, paint, metal, glass, stone, marble & plastic
- Waterproof paper backing for wet and dry sanding

FERR. & NON FERR. PAINT/VARN STONE

	DIM WxL (mm)	GRIT	PK QTY	ART NO.	PRICE	
		230 x 280	60	50	63642532956	£000.00
		80	50	63642532988	£000.00	
		100	50	63642532989	£000.00	
		120	50	63642532990	£000.00	
		150	50	63642532991	£000.00	
		180	50	63642532957	£000.00	
		220	50	63642532992	£000.00	
		240	50	63642532993	£000.00	
		280	50	63642532994	£000.00	
		320	50	63642532995	£000.00	
		360	50	63642532996	£000.00	
		400	50	63642532997	£000.00	
		500	50	63642532998	£000.00	
		600	50	63642532999	£000.00	
		800	50	63642533000	£000.00	
1000	50	63642533001	£000.00			
1200	50	63642533002	£000.00			

SHEETS & HAND PADS FOR HAND SANDING

T100 WATERPROOF SHEETS **+++**

- Aluminium oxide abrasive
- Waterproof paper backing for wet and dry sanding

- Multi-purpose product
- Excellent price / performance ratio

FERR.
& NON FERR.



PAINT/
VARN



	DIM WxL (mm)	GRIT	PK QTY	ART NO.	PRICE
	230 x 280	60	50	77696081101	£000.00
		80	50	77696069788	£000.00
		100	50	77696081102	£000.00
		120	50	77696081103	£000.00
		150	50	77696081104	£000.00
		180	50	77696081105	£000.00
		220	50	77696069787	£000.00
		240	50	77696081106	£000.00
		280	50	77696081107	£000.00
		320	50	77696069784	£000.00
		360	50	77696081108	£000.00
		400	50	77696081109	£000.00
		500	50	77696081110	£000.00
		600	50	77696081111	£000.00
		800	50	77696081112	£000.00
	1000	50	77696081113	£000.00	
	1200	50	77696081114	£000.00	
	1500	50	63642531009	£000.00	



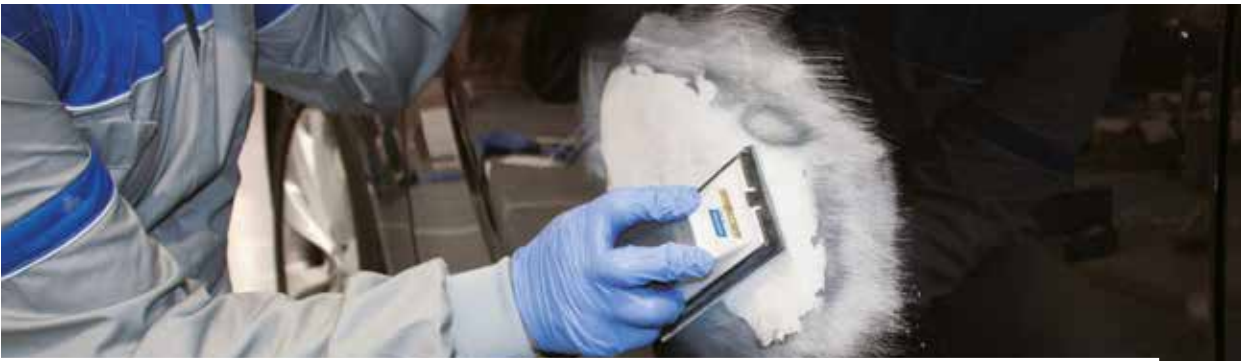

NORTON MESHPOWER SHEETS

An alternative to traditional perforated paper sheets, Norton MeshPower is a multifunctional abrasive, designed with thousands of holes, created by the unique mesh matrix structure. This hole structure allows dust extraction in any application.

- Mesh backing enables excellent dust extraction, for a cleaner working environment and less clean up time
- No-fil® technology prevents clogging for longer product life
- Can be used wet or dry
- Self-grip backing for a quick and easy sheet change
- Can be used on many materials, flat and contoured surfaces, by hand or machine
- No defined hole pattern for fast, easy alignment with the back-up pad
- Easy to identify product type by grain colour

POWERFUL DUST EXTRACTION MEANS A CLEANER ENVIRONMENT

The demand for a cleaner working environment, better quality finish and reduced consumable cost, means sanding solutions have evolved, from paper backed abrasive to a mesh construction with thousands of tiny holes.

Norton MeshPower responds to these demands by offering dust extraction in many operations. The open mesh construction of the backing allows dust particles to flow freely through thousands of tiny holes, creating a virtually dust free sanding environment. Better for your health, better for your application and better for your business!

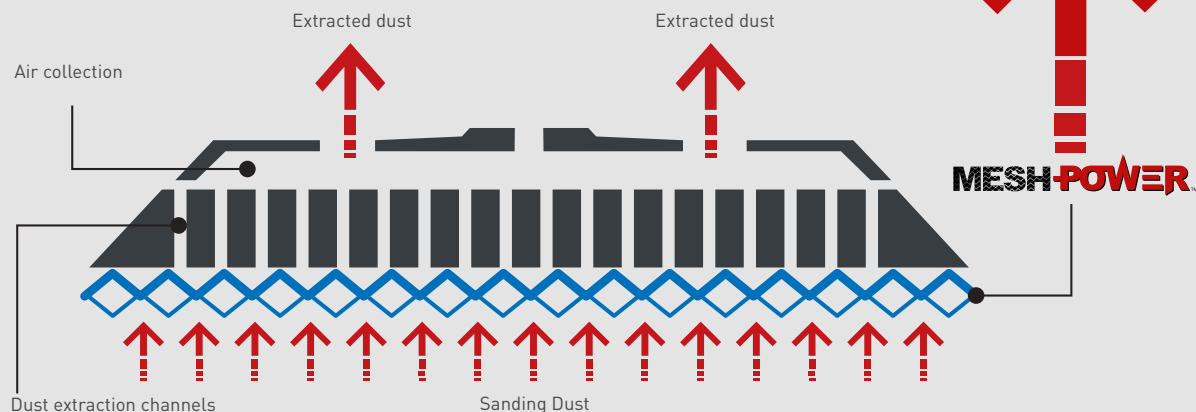

CERAMIC ADVANTAGE

Ceramic grain provides the ultimate material removal, best productivity, longest life and finest finish.

NEW MESHPOWER CUT SHEETS CERAMIC

DIM WxL (mm)	GRIT	PK QTY	ART NO.	PRICE
70x125	80	50	69957325770	£000.00
	120	50	69957325772	£000.00
	180	50	69957325773	£000.00
	240	50	69957325774	£000.00
	320	50	69957325775	£000.00
70x198	80	50	69957325962	£000.00
	120	50	69957325963	£000.00
	180	50	69957325964	£000.00
	240	50	69957325965	£000.00
	320	50	69957325966	£000.00
70x420	80	50	69957325986	£000.00
	120	50	69957325987	£000.00
	180	50	69957325988	£000.00
	240	50	69957325990	£000.00
	320	50	69957325991	£000.00
115x230	80	50	69957326057	£000.00
	120	50	69957326062	£000.00
	180	50	69957326063	£000.00
	240	50	69957326065	£000.00
	320	50	69957326068	£000.00

NEW MESHPOWER CUT SHEETS ALUMINIUM OXIDE

DIM WxL (mm)	GRIT	PK QTY	ART NO.	PRICE
70x198	80	50	69957326280	£000.00
	120	50	69957326281	£000.00
	180	50	69957326283	£000.00
	240	50	69957326285	£000.00
	320	50	69957326286	£000.00
70x420	80	50	69957326288	£000.00
	120	50	69957326289	£000.00
	180	50	69957326291	£000.00
	240	50	69957326292	£000.00
	320	50	69957326294	£000.00



BEARTEX SHEETS & HAND PADS

Hand pads are ideal for a broad range of applications from cleaning and finishing to deburring and light polishing operations. The flexibility of Beartex products ensures constant contact with the surface and prevents cutting or gouging when working. Can be folded to suit hand / shape. Perforated pads for clean and easy tearing also available. These perforations allow for smooth, shred free split to create 2 smaller, easy to use 115mm x 150mm pads

BEARTEX HAND PADS

- Open mesh construction resists clogging
- Flexible, conforms to curves, contours and tight spaces easily, will not break
- Waterproof, washable and reusable
- Lasts longer than standard sandpaper and will not gouge the workpiece when used

	DIM W x L (mm)	GRADE	CAP CODE	PK QTY	ART NO.	PRICE
HAND PADS						
	150x230	Extra Cut A	F2302	20	63642557491	£000.00
		Heavy Duty	F2316	20	63642577268	£000.00
		Medium A	F2300	20	63642557493	£000.00
		Fine A	F2401	20	66261018286	£000.00
		Very Fine A Long Life	F2504	20	66261018287	£000.00
		Gen. Purpose Clean & Scour A	F2568	20	63642574103	£000.00
		Medium S	F4300	20	66261039806	£000.00
		Ultra Fine S	F4807	20	77696046252	£000.00
		Micro Fine A	F2801	20	63642557277	£000.00
		White Cleaning (Non Abrasive)	F0001	20	66261018283	£000.00
	230x280	Very Fine A Long Life	F2504	20	66261018291	£000.00
		Ultra Fine S	F4807	20	66261018292	£000.00
	PERFORATED HAND PADS (PRE-CUT)					
	150x230	Very Fine A Long Life	F2504	20	66261018293	£000.00
		Ultra Fine S	F4807	20	66261018294	£000.00

SHEETS & HAND PADS FOR HAND SANDING

THIN FLEX HAND PADS

- Thinner special coated web design cuts fast and saves time
- Ultra flexible so conforms even better to contoured surfaces for an ultra consistent scratch pattern
- Ideal for getting into tight spaces as pads can be scrunched and rolled
- Advanced web formation provides superior grain adhesion, durability and product life
- Ideal for woodworking, metalworking, maintenance operations as well as car body repair.

	DIM WxL (mm)	GRADE	CAP CODE	PK QTY	ART NO.	PRICE
	115x230	Very fine A long life	F2543	4x25	63642506166	£000.00
		Ultra fine S	F4614	4x25	63642506167	£000.00
		Micro fine A	F2804	10x10	66261113519	£000.00

Dimensions Key: DIM = Dimensions, W = Width, L = Length

PRODUCT SELECTION GUIDE

CAP CODE	GRADE	ABRASIVE	TARGET MATERIAL	APPLICATION	BENEFITS
HAND PADS (IN ORDER OF DECREASING AGGRESSIVENESS)					
F2316	Extra cut	Aluminium oxide	Stainless steel	<ul style="list-style-type: none"> • Rust removal • Blending • Deburring • Bluing removal 	<ul style="list-style-type: none"> • Aggressive & durable • Long life • Ideal replacement for coated abrasive steel wool & wire brushes
F2300	Medium	Aluminium oxide	Metals & ceramics	<ul style="list-style-type: none"> • Cleaning, deburring • Rust removal • Coating removal 	<ul style="list-style-type: none"> • Strong & open construction • Resists loading • Long life • Ideal for achieving a matt satin finish
F2401	Fine	Aluminium oxide	Wood & plastics	<ul style="list-style-type: none"> • Cleaning & Intermediate finishing of ferrous & non-ferrous metals • Defuzzing wood, denibbing laquers, paints & plastic 	<ul style="list-style-type: none"> • Coarser & stiffer than very fine pad • Ideal for achieving a matt satin finish
F2560/ F2529	Very fine	Aluminium oxide	General purpose	<ul style="list-style-type: none"> • Rust removal • Automotive primer keying • Defuzzing wood, denibbing plastic 	<ul style="list-style-type: none"> • Conforms well to contoured surfaces • Excellent finish on a wide variety of surfaces
F2504	Very fine (long life)	Aluminium oxide	General purpose	<ul style="list-style-type: none"> • Rust removal • Automotive primer keying • Defuzzing wood, denibbing plastic, • Light sanding of old paint and new primers 	<ul style="list-style-type: none"> • Moderate flexibility • Fast initial cut • Long life • No colour blend when used with solvents
F2568	Gen. purpose clean & scour	Alumina silicate	Metals & plastics	<ul style="list-style-type: none"> • General purpose cleaning, surface preparation prior to painting • Removal of light stains & oxide marks on metal surfaces 	<ul style="list-style-type: none"> • Low cost pad • Good performance at an economical price
F4300	Medium (SiC)	Silicon carbide	Stainless steel	<ul style="list-style-type: none"> • Satin finishing aluminium, cleaning glass moulds • Grain finishing, removal of weld bluing on stainless steel 	<ul style="list-style-type: none"> • Resilient • Conforms well to surface contours
F4660/ F4807/ F4605	Ultra fine	Silicon carbide	General purpose	<ul style="list-style-type: none"> • Keying clear coat, finishing metal, deburring plastics, finishing aluminium • Doors & window frames, blending paint, scuffing varnishes & keying acrylic coatings 	<ul style="list-style-type: none"> • Can be used wet or dry with prepping compounds
F2801/ F2829	Micro fine	Calcined alumina	Precious metals, varnished wood, car body work	<ul style="list-style-type: none"> • Keying clear coat • Polishing 	<ul style="list-style-type: none"> • Produces an extremely high quality surface finish • Ideal for cleaning precious metals and finishing varnished wood
F0001	White cleaning	None	All surfaces	<ul style="list-style-type: none"> • Light cleaning, polishing • Rubbing down primer & highlighting wood 	<ul style="list-style-type: none"> • Highly conformable • Tear resistant • Ideal for use with liquid detergent



ABRASIVE SPONGES FOR HAND SANDING

Abrasive sanding sponges are designed for use on wood, paint and metal. Their flexible nature means they can be used on curved, contoured and flat surfaces.

PRODUCT SELECTION GUIDE

MATERIAL	APPLICATION	GRIT
All materials	Rough sanding	60
	Semi-finishing	100
	Finishing	180 +

ABRASIVE SPONGES APPLICATION GUIDE

GRADE	GRIT	FINISH GENERATED	APPLICATIONS
Medium	60	180/120	Scuffing, shaping filler
Fine	100	400/320	Feather edging, scuffing primer, and new parts before painting
Super fine	180	600/500	Preparing panel for base coat
Ultra fine	220	1000/800	Sanding base coat, removing clear coat defects
Micro fine	280	1500/1200	Clear coat sanding, removing minor defects

ABRASIVE SPONGES FOR HAND SANDING

SPONGES

- Multi-purpose, can be used for wet or dry sanding
- Easy to reach areas inaccessible to sandpaper sheets
- Conforms to surface shapes & contours, providing a uniform finish
- Washable & robust can be reused, extending product life

ONE SIDED ABRASIVE

FERR. & NON FERR. 

PAINT/VARN, PLASTER & FILLER, HARD WOOD & SOFT WOOD 

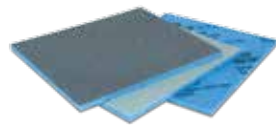

DIM WxLxH (mm)	GRIT	PK QTY	ART NO.	PRICE
140x115x6	60	20	63642550599	£000.00
	100	20	63642550601	£000.00
	180	20	63642550602	£000.00
	220	20	63642550603	£000.00
	280	20	63642550604	£000.00

TWO SIDED ABRASIVE



DIM WxLxH (mm)	GRIT	PK QTY	ART NO.	PRICE
123x98x12,5	60	60	7660717578	£000.00
	100	60	7660705187	£000.00
	180	60	7660705188	£000.00
123x98x12,5	60	250	7660719341	£000.00
	100	250	7660719342	£000.00
	180	250	7660719343	£000.00

FOUR SIDED ABRASIVE



DIM WxLxH (mm)	GRIT	PK QTY	ART NO.	PRICE
100x66x26	60	60	7660717579	£000.00
	100	60	7660705189	£000.00
	180	60	7660705190	£000.00
100x66x26	100	250	7660719345	£000.00
	180	250	7660719346	£000.00

Dimensions Key: DIM = Dimensions, W = Width, L = Length, H = Height



Abrasive sponges generate a finer finish than conventional coated abrasive products. The sponges are washable and can be reused, giving greater product life.



REASONS TO CHOOSE A SPONGE VS CONVENTIONAL SHEET

ELIMINATE CLOGGING

- The combination of flexible foam backing material and abrasive grit adhesion continually releases sanded material
- Any clogging can be washed out

PRESSURE CONTROL

- Foam backing optimum pressure distribution to prevent sanding through surfaces
- Pressure spots are eliminated providing even surface pattern

ADAPT TO CONTOURS

- Flexible foam allows adaptability to contours, shapes or areas of limited access
- No folding or buckling results in an even pattern without scratching



NORTON

SAINT-GOBAIN[®]

COATED

BELTS

File belts
Portable belts

174
180

Narrow belts
Rapid Prep belts

183
191



FILE BELTS FOR FILE BELT MACHINES

Norton offers a wide range of file belts designed to outstanding performance on intricate shapes and contours. Portable file belt sanders have replaced tedious hand filing and sanding. First introduced in pneumatic, they are now also available in electric. Increasingly, tool manufacturers are introducing additional fixtures for additional applications. The belts listed are popular stock sizes, but additional sizes, specifications, backing materials, and edge scallops are available made-to-order

PRODUCT SELECTION GUIDE

Highly recommended ●
Recommended ◐
Satisfactory ○

	VIKING R996	SG R929	NORZON R822	NORZON R817	R445	R293	R230
	+++++	+++++	++++	++++	+++	+++	+++
Stainless steel, inox & duplex	●	●	◐			○	
Inconel, titanium & super alloys	●	●	◐			○	
Carbon, construction & mild steels		●	◐			○	
Cast iron		◐	●			○	
Non-ferrous metal (brass/aluminium)				●	○	◐	○
Hard & soft wood				●			◐
Composite materials					●		○
Stone, concrete					●	○	
Glass, plastic					●	○	
Rubber, plastic				●		◐	○
Leather				●		◐	○

VIKING R996 **+++++** INNOVATION

- The best choice for use on stainless steel, inconels, chromium cobalt, titanium and extremely hard materials
- Maximum performance for lowest overall grinding cost on the most difficult-to-grind materials
- Heavy duty applications with the highest stock removal, reduced heat, loading and glazing
- Advanced "supersize" grinding aid for fast and consistent cut rate with less off hand pressure required to cut



	WxL (mm)	GRIT	PK QTY	ART NO.	PRICE
	9x533	40	10	66261128510	£000.00
		60	10	66261128511	£000.00
		80	10	66261128512	£000.00
	13x457	40	10	66261128495	£000.00
		60	10	66261128498	£000.00
		80	10	66261128499	£000.00
	15x475	40	10	66261128521	£000.00
		60	10	66261128522	£000.00
		80	10	66261128523	£000.00
	19x457	40	10	66254480433	£000.00
		60	10	66254408250	£000.00
		80	10	66254471640	£000.00

SG R929 **+++++**

- Made with premium SG abrasive grain, perfect for heat sensitive metals
- High content of active filler for cool cut, no burn marks on the metal part
- Excellent performance at low & medium pressure
- X-weight polyester cloth, extremely durable even on aggressive applications



	WxL (mm)	GRIT	PK QTY	ART NO.	PRICE
	6x457	40	10	66261123531	£000.00
		60	10	66261123532	£000.00
		80	10	66261123533	£000.00
		120	10	66261123535	£000.00
	6x520	40	10	66261123543	£000.00
		60	10	66261123545	£000.00
		80	10	66261123546	£000.00
		120	10	66261123547	£000.00
	9x533	40	10	66261123552	£000.00
		60	10	66261123553	£000.00
		80	10	66261123554	£000.00
		120	10	66261123555	£000.00
	10x330	40	10	66623303110	£000.00
		60	10	66261144369	£000.00
		80	10	66623303270	£000.00
		120	10	66623303271	£000.00

Dimensions Key: W = Width, L = Length

FILE BELTS FOR FILE BELT MACHINES

WxL (mm)	GRIT	PK QTY	ART NO.	PRICE
13x305	40	10	66261194353	£000.00
	60	10	66261023616	£000.00
	80	10	66261023617	£000.00
	120	10	66261023618	£000.00
13x457	40	10	66261123522	£000.00
	60	10	66261123523	£000.00
	80	10	66261123524	£000.00
	120	10	66261123525	£000.00
13x610	40	10	66261123636	£000.00
	60	10	66261123638	£000.00
	80	10	66261123639	£000.00
	120	10	66261123640	£000.00
15x475	40	10	66261123646	£000.00
	60	10	66261123647	£000.00
	80	10	66261123648	£000.00
	120	10	66261123649	£000.00
19x457	40	10	66254487679	£000.00
	60	10	66254480427	£000.00
	80	10	66254481839	£000.00
	120	10	66254481840	£000.00
20x520	40	10	66623303272	£000.00
	60	10	66261029755	£000.00
	80	10	66623303275	£000.00
	120	10	66623303276	£000.00

NORZON R817

- Norzon grain continually exposes new cutting surfaces for long belt life even at high pressure
- Heavy polyester cloth, stiff tear resistant for tough applications
- Ideal for grinding skis
- High-performance resin bond provides strong grain adhesion, extending belt life
- Open grain distribution, recommended for grinding soft materials like aluminium, plastic, rubber or leather

NON FERR. PLASTIC, RUBBER & LEATHER 

WxL (mm)	GRIT	PK QTY	ART NO.	PRICE
30x533	24	10	69957383624	£000.00
	36	10	63642571575	£000.00
	40	10	63642556322	£000.00
34x435	24	10	63642545273	£000.00
	36	10	63642568989	£000.00
	40	10	63642549470	£000.00

NORZON R822

- Norzon grain continually exposes new cutting surfaces for long belt life even at high pressure
- Extremely durable for use in all demanding applications
- X-weight cotton backing for moderate to light pressure applications

FERR. & NON FERR. 





WxL (mm)	GRIT	PK QTY	ART NO.	PRICE
10x330	40	10	66261144347	£000.00
	60	10	66261144348	£000.00
	80	10	66261144349	£000.00
	120	10	66261144350	£000.00
13x305	40	10	66261194351	£000.00
	60	10	63642552143	£000.00
	80	10	63642524376	£000.00
	120	10	69957308462	£000.00
13x457	40	10	66261141253	£000.00
	60	10	66261141254	£000.00
	80	10	66261141255	£000.00
	120	10	66261141256	£000.00
13x610	40	10	66261141257	£000.00
	60	10	63642539830	£000.00
	80	10	66261141260	£000.00
	120	10	66261141261	£000.00
15x475	40	10	66261141262	£000.00
	60	10	66261141263	£000.00
	80	10	66261141264	£000.00
	120	10	66261141265	£000.00
19x457	40	10	66623330766	£000.00
	60	10	63642539828	£000.00
	80	10	63642539836	£000.00
	120	10	63642539843	£000.00
20x520	40	10	66261141266	£000.00
	60	10	66261141267	£000.00
	80	10	66261141269	£000.00
	120	10	66261141270	£000.00
30x533	40	10	63642538962	£000.00
	60	10	63642538963	£000.00
	80	10	63642538964	£000.00
35x440	40	10	77696087694	£000.00
	60	10	66261032676	£000.00
	80	10	63642510293	£000.00
	120	10	77696087695	£000.00

Dimensions Key: W = Width, L = Length

FILE BELTS FOR FILE BELT MACHINES



R445

- Hard and sharp silicon carbide grains for medium duty applications
- Can be used for dry or wet due to polyester backing
- For high initial cut on non-ferrous and soft-loading materials such as glass, titanium, masonry, composites, plastic and rubber

	WxL (mm)	GRIT	PK QTY	NON FERR. STONE, GLASS 	
				ART NO.	PRICE
	15x475	60	50	63642547214	£000.00
		80	50	63642539677	£000.00
		120	50	63642539678	£000.00
	20x520	60	50	66254425393	£000.00
		80	50	63642567304	£000.00
		120	50	63642547790	£000.00
	30x533	60	50	63642519009	£000.00
		80	50	69957379493	£000.00
		120	50	69957371884	£000.00

R293

- General purpose aluminium oxide belt, good price / performance ratio
- Resin bond system provides good edge retention and life versus other belts
- For high initial cut on non-ferrous and soft-loading materials such as glass, titanium, masonry, composites, plastic and rubber
- With active filler for improved life on metal applications

	WxL (mm)	GRIT	PK QTY	FERR. & NON FERR. 	
				ART NO.	PRICE
	9x533	40	10	66254470284	£000.00
		60	10	63642508840	£000.00
		80	10	66254470277	£000.00
		120	10	66254470279	£000.00
	15x475	40	10	63642548466	£000.00
		60	10	63642548527	£000.00
	13x610	40	10	66623394060	£000.00
		60	10	66254469666	£000.00
		80	10	66623399824	£000.00
	20x520	40	10	69957380369	£000.00
		60	10	69957377467	£000.00
		80	10	66623385919	£000.00
120		10	63642513153	£000.00	

Dimensions Key: W = Width, L = Length

R230

- Hard aluminum oxide abrasive for good product life
- Open grain distribution for reduced clogging and loading material such as wood & aluminium
- Ideal for sanding wood & grinding metal
- Good cut rate on low-pressure finishing operations with ability to leave a very good finish



	WxL (mm)	GRIT	PK QTY	ART NO.	PRICE
	10x330	40	10	69957385707	£000.00
		60	10	66261114049	£000.00
		80	10	63642515415	£000.00
		120	10	69957380686	£000.00
	20x520	40	10	69957396131	£000.00
		60	10	66261034453	£000.00
		80	10	66261106250	£000.00
		120	10	66623327675	£000.00
	30x533	40	10	63642546483	£000.00
		60	10	63642546477	£000.00
		80	10	63642546478	£000.00
		120	10	63642546482	£000.00
	34x435	40	10	77696076121	£000.00
		60	10	63642550019	£000.00
		80	10	63642549933	£000.00

Dimensions Key: DIM = Dimensions, W = Width, L = Length

MADE-TO-ORDER PRODUCT AVAILABILITY

CAP CODE	GRAIN / GRIT	24	36	40	60	80	100	120	150	180	220	240	280	320	400
Viking R996	New SG supersize, YY/Y-polyester	•	•	•	•	•									
SG R929	SG, X-polyester		•	•	•	•	•	•							
Norzon R822	Norzon, X-cotton	•	•	•	•	•	•	•	•						
Norzon R817	Norzon, Y-polyester	•	•	•	•	•	•	•							
R445	Silicon carbide, X/Y-polyester				•	•	•	•	•	•	•	•			
R293	Blend aluminium oxide, X/Y-polyester	•	•	•	•	•	•	•	•	•	•	•	•	•	•
R230	Aluminium oxide, X-cotton		•	•	•	•	•	•	•	•					

MINIMUM ORDER QUANTITIES FOR MADE-TO-ORDER PRODUCTS

SIZE (mm)	MINIMUM ORDER QUANTITY
All file belts	200 pieces



PORTABLE BELTS FOR PORTABLE BELT MACHINES

Norton offers portable belts in a variety of sizes, designed to fit the most common types of machine. Portable belts are designed for all metal and wood working applications. Choose 36 – 50 grits for rough/heavy-duty applications, 60 – 100 for intermediate, and 100 – 220 for finishing/polishing applications. The belts listed are popular stock sizes, but additional sizes, specifications, and backing materials, are available made-to-order. All Norton belts are supplied with butt joints for easy mounting and smoother work.

PRODUCT SELECTION GUIDE

Highly recommended ●
Recommended ○
Suitable ○

	SG R929	NORZON R817	R230
MATERIAL	+++++	++++	+++
Metal	●		○
Hard wood		●	○
Soft wood		○	●

SG R929 **+++++**

- Premium SG abrasive grain ideal for heat sensitive metals
- High content of active filler for cool cut, no burn marks on the metal part
- X-weight polyester cloth, extremely durable even in aggressive applications
- Excellent performance at low & medium pressure



	WxL (mm)	GRIT	PK QTY	ART NO.	PRICE
	50x800	60	10	66261023832	£000.00
		80	10	66261023833	£000.00
		120	10	66261023834	£000.00

NORZON R817 **++++**

- Norzon grain continually exposes new cutting surfaces for long belt life even at high pressure
- Heavy polyester cloth, stiff and tear resistant for tough applications
- High-performance resin bond provides strong grain adhesion for longer belt life
- Open grain distribution prevents loading when grinding wood and soft materials like aluminium, plastic, rubber or leather

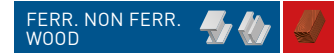

	WxL (mm)	GRIT	PK QTY	ART NO.	PRICE
	200x750	36	10	63642515116	£000.00
		40	10	69957355996	£000.00
		60	10	69957371516	£000.00
		80	10	69957371517	£000.00
		100	10	66261182174	£000.00
		120	10	69957371513	£000.00

R230 **+++**

- Hard aluminum oxide abrasive for good product life
- Open grain distribution for reduced clogging on materials such as wood & aluminium
- Multi-purpose product ideal for sanding wood & grinding metal
- Excellent cut rate on low-pressure finishing operations, imparts a good finish



	WxL (mm)	GRIT	PK QTY	ART NO.	PRICE
	75x457	40	10	63642538877	£000.00
		60	10	63642539426	£000.00
		80	10	63642539422	£000.00
		120	10	63642539415	£000.00
	75x533	40	10	63642546289	£000.00
		60	10	63642546257	£000.00
		80	10	63642534248	£000.00
		100	10	63642546273	£000.00
		120	10	63642530701	£000.00

Dimensions Key: W = Width, L = Length

PORTABLE BELTS FOR PORTABLE BELT MACHINES

	WxL (mm)	GRIT	PK QTY	ART NO.	PRICE
	75x610	40	10	63642546472	£000.00
		60	10	63642546473	£000.00
		80	10	63642567329	£000.00
		100	10	63642545869	£000.00
		120	10	63642546476	£000.00
	100x610	40	10	63642546295	£000.00
		60	10	63642560145	£000.00
		80	10	63642529798	£000.00
		100	10	63642546242	£000.00
		120	10	63642529797	£000.00
	100x620	40	10	63642546457	£000.00
		60	10	63642534465	£000.00
80		10	63642529799	£000.00	
100		10	63642534770	£000.00	
120		10	63642546452	£000.00	
100x690	40	10	63642537627	£000.00	
	60	10	63642537544	£000.00	
	80	10	63642537546	£000.00	
	100	10	63642537548	£000.00	
	120	10	63642537632	£000.00	
200x750	24	10	63642521182	£000.00	
	36	10	69957349006	£000.00	
	40	10	69957349007	£000.00	
	60	10	69957349010	£000.00	
	80	10	69957349014	£000.00	
	100	10	69957349394	£000.00	

Dimensions Key: W = Width, L = Length

MADE-TO-ORDER PRODUCT AVAILABILITY

CAP CODE	GRAIN / GRIT	24	36	40	60	80	100	120	150	180	220	240	280	320	400
SG R929	SG, X-polyester		•	•	•	•	•	•							
Norzon R817	Norzon, Y-polyester	•	•	•	•	•	•	•							
R230	Aluminium oxide, X-cotton		•	•	•	•	•	•	•	•					

MINIMUM ORDER QUANTITIES

FOR MADE-TO-ORDER PRODUCTS

SIZE (mm)	MINIMUM ORDER QUANTITY
All portable belts	100 pieces



NARROW BELTS FOR BACKSTAND MACHINES

A broad selection of sizes and grits for most dimensioning, intermediate grinding and polishing applications. The belts listed are popular stock sizes, but additional sizes, specifications, and backing materials, are available made-to-order.

PRODUCT AVAILABILITY

Highly recommended ●
Recommended ○
Suitable ○

	VIKING R996	RED-X R976	SG R929	NORAX **	H231**	BLUE FORCE R874	NORZON R822	W445	R445	R293
MATERIAL	+++++	+++++	+++++	+++++	+++++	++++	++++	++++	+++	+++
Stainless steel, inox & duplex	●	○	○	●						
Inconel, titanium & super alloys	●	○	○	●						
Carbon, construction & mild steels			●			○	○		○	○
Cast iron			●			○	○		○	○
Non-ferrous metal (brass/aluminium)			●			○	○		○	○
Hard & soft wood					●					
Stone, concrete									●	○
Glass, plastic								●	○	

NARROW BELTS FOR BACKSTAND MACHINES

VIKING R996 **+++++** INNOVATION

- The best choice for use on stainless steel, inconels, chromium cobalt, titanium and extremely hard materials
- The maximum performance for lowest overall grinding cost on your most difficult-to-grind materials
- Achieve maximum stock removal, reduced heat generation and no loading and glazing in heavy duty applications
- 'Supersize' layer applied to the abrasive reduces heat generation and cuts faster, even with less off hand pressure



WxL (mm)	GRIT	PK QTY	ART NO.	PRICE
50x2000	NEW 24	10	69957364731	£000.00
	36	10	66254403822	£000.00
	40	10	66254403847	£000.00
	60	10	66254411262	£000.00
	80	10	66254449025	£000.00
50x2500	NEW 24	10	69957364732	£000.00
	36	10	66261099222	£000.00
	40	10	66254408229	£000.00
	60	10	66254416129	£000.00
	80	10	66254448015	£000.00
50x3500	NEW 24	10	69957364733	£000.00
	36	10	66254404039	£000.00
	40	10	66254404041	£000.00
	60	10	66254436885	£000.00
	80	10	66254456931	£000.00
50x4000	NEW 24	10	69957300743	£000.00
	36	10	66254404064	£000.00
	40	10	66254404065	£000.00
	60	10	66254405015	£000.00
	80	10	66254444896	£000.00
75x2000	NEW 24	10	69957364735	£000.00
	36	10	66254410065	£000.00
	40	10	66254407955	£000.00
	60	10	66254407954	£000.00
	80	10	66254456158	£000.00
75x2500	NEW 24	10	69957364736	£000.00
	36	10	66254403849	£000.00
	40	10	66254403887	£000.00
	60	10	66254403891	£000.00
	80	10	66254469059	£000.00

Dimensions Key: W = Width, L = Length



NEW RED-X R976 **+++++**

- Patented ceramic SG grain for increased cut rate on carbon and stainless steel
- A new high performance formulation of supersize layer for excellent results on materials from stainless steel to inconel to titanium
- Higher material removal rate at low and medium pressure in fine grits
- Reduced heat generation reduces risk of burn



	WxL (mm)	GRIT	PK QTY	ART NO.	PRICE
	50x2000	36	10	66623381099	£000.00
		40	10	66623328023	£000.00
		60	10	66254401458	£000.00
		80	10	66261108229	£000.00
		120	10	66254408387	£000.00
	50x2500	36	10	66254410572	£000.00
		40	10	66261051186	£000.00
		60	10	66261063897	£000.00
		80	10	66254401374	£000.00
		120	10	66261107250	£000.00
	50x3500	36	10	66254409222	£000.00
		40	10	66623385396	£000.00
		60	10	66261071965	£000.00
		80	10	66254436884	£000.00
		120	10	66254411405	£000.00
	50x4000	36	10	66261055060	£000.00
		40	10	66261092227	£000.00
		60	10	66261054920	£000.00
		80	10	66254401290	£000.00
		120	10	66254474052	£000.00
	75x2000	36	10	66623319745	£000.00
		40	10	66261067686	£000.00
		60	10	66261060879	£000.00
		80	10	66254403117	£000.00
		120	10	66254404255	£000.00
	75x2500	36	10	66261066499	£000.00
		40	10	66254402279	£000.00
		60	10	66254433345	£000.00
		80	10	66254407537	£000.00
		120	10	66254407535	£000.00

NARROW BELTS FOR BACKSTAND MACHINES

SG R929

- Premium SG abrasive ideal for heat sensitive metals as the SG grain reduces heat generation
- High content of active filler for cool cut, no burn marks on the metal part
- X-weight polyester cloth, extremely durable even on aggressive applications
- Excellent performance at low & medium pressure

FERR. & NON FERR. 

	WxL (mm)	GRIT	PK QTY	ART NO.	PRICE
	50x1600	40	10	66261023879	£000.00
		50	10	66261023880	£000.00
		60	10	66261023881	£000.00
		80	10	66261023882	£000.00
	50x2000	36	10	69957350787	£000.00
		40	10	69957350790	£000.00
		50	10	69957350792	£000.00
		60	10	69957350793	£000.00
		80	10	69957350794	£000.00
		120	10	69957350795	£000.00
	75x2000	36	10	69957350796	£000.00
		40	10	69957350797	£000.00
50		10	69957350798	£000.00	
60		10	69957350799	£000.00	
80		10	69957350800	£000.00	
100		10	66261024222	£000.00	
120		10	69957350801	£000.00	
75x2500		36	10	69957350882	£000.00
	40	10	69957350883	£000.00	
	50	10	69957350884	£000.00	
	60	10	69957350888	£000.00	
	80	10	69957350898	£000.00	
	120	10	66261023977	£000.00	
100x1000	40	10	69957350903	£000.00	
	50	10	69957350905	£000.00	
	60	10	69957350906	£000.00	
100x2000	36	10	69957350802	£000.00	
	40	10	69957350804	£000.00	
	60	10	69957350805	£000.00	
	80	10	69957350806	£000.00	
	120	10	69957350807	£000.00	
150x2000	36	10	69957350809	£000.00	
	40	10	69957350812	£000.00	
	60	10	69957350813	£000.00	
	80	10	69957350815	£000.00	
150x2500	40	10	66261023984	£000.00	
	60	10	66261023992	£000.00	
	80	10	66261023993	£000.00	

NEW NORZON R874

- Optimized grain coverage for maximum efficiency
- Needle shape grain with engineered micro fracturing for aggressive cutting action
- High stock removal and long life
- YY-weight polyester cloth for medium and high pressure

FERR. & NON FERR. 

	WxL (mm)	GRIT	PK QTY	ART NO.	PRICE
	50x2000	24	10	66623342805	£000.00
		36	10	66623381098	£000.00
		40	10	66623337486	£000.00
		60	10	66623312376	£000.00
		80	10	66623337488	£000.00
		120	10	66623312377	£000.00
	75x2000	24	10	66623301373	£000.00
		36	10	66623314617	£000.00
		40	10	66623307514	£000.00
		60	10	66623307515	£000.00
		80	10	66623307023	£000.00
		120	10	66623307958	£000.00
	75x2500	36	10	66623327524	£000.00
		40	10	66623302265	£000.00
		60	10	66623303466	£000.00
		80	10	66623328229	£000.00
		120	10	66623304426	£000.00

NARROW BELTS FOR BACKSTAND MACHINES

NORZON R822

- High-performance, self-sharpening zirconia alumina abrasive for excellent cut rate and product life
- Extremely durable for demanding applications
- X-weight cotton backing for moderate to light pressure applications

FERR. & NON FERR. 



WxL (mm)	GRIT	PK QTY	ART NO.	PRICE
50x2000	36	10	63642546222	£000.00
	40	10	63642547270	£000.00
	60	10	63642546210	£000.00
	80	10	63642546212	£000.00
	120	10	63642516010	£000.00
75x2000	24	10	63642539088	£000.00
	36	10	63642539386	£000.00
	40	10	63642539388	£000.00
	50	10	63642538998	£000.00
	60	10	63642539389	£000.00
	80	10	63642538999	£000.00
	120	10	63642539002	£000.00
75x2500	36	10	63642546092	£000.00
	40	10	63642546094	£000.00
	60	10	63642546097	£000.00
	80	10	63642546099	£000.00
100x920	36	10	63642546226	£000.00
	40	10	63642539330	£000.00
	50	10	63642539328	£000.00
	60	10	63642546216	£000.00
	80	10	63642546214	£000.00
	100	10	63642539383	£000.00
100x1000	40	10	63642547284	£000.00
	50	10	63642538971	£000.00
	60	10	63642538973	£000.00
	80	10	63642538975	£000.00
	100	10	63642538977	£000.00
	120	10	63642536388	£000.00
150x2000	36	10	63642539008	£000.00
	40	10	63642539010	£000.00
	60	10	63642539014	£000.00
	80	10	63642539016	£000.00

Dimensions Key: W = Width, L = Length

W445

- Special cork grain for polishing glass and final finishing of glass edges
- Can be used wet or dry
- Long life with uniform polishing effect



GLASS

WxL (mm)	GRIT	PK QTY	ART NO.	PRICE
100x2000	No abrasive grain	10	63642580818	£000.00
100x3350	No abrasive grain	10	63642545206	£000.00
140x3300	No abrasive grain	10	66254415118	£000.00

R293

- General purpose aluminium oxide belt with good price / performance ratio
- Resin bond system provides good grain retention and life versus key competitors
- For high initial cut on non-ferrous and soft-loading materials such as glass, titanium, masonry, composites, plastic and rubber
- With active filler for improved life on metal applications



FERR. NON FERR. WOOD

WxL (mm)	GRIT	PK QTY	ART NO.	PRICE
50x2000	36	10	63642546943	£000.00
	40	10	63642551489	£000.00
	60	10	63642546878	£000.00
50x4000	36	10	63642539981	£000.00
	40	10	63642539982	£000.00
	60	10	63642539985	£000.00
	80	10	63642539986	£000.00
75x2000	36	10	63642547942	£000.00
	40	10	63642564728	£000.00
	60	10	63642548528	£000.00
	80	10	63642548275	£000.00
75x2500	36	10	63642546130	£000.00
	40	10	63642546874	£000.00
	60	10	63642551507	£000.00
100x920	40	10	63642548306	£000.00
	60	10	63642548307	£000.00
	80	10	63642551544	£000.00
	100	10	63642551546	£000.00
	120	10	63642551547	£000.00
100x3000	180	10	63642551549	£000.00
	40	10	63642551511	£000.00
	60	10	63642548447	£000.00

Dimensions Key: W = Width, L = Length

NARROW BELTS FOR BACKSTAND MACHINES

R445

- Hard and sharp silicon carbide grain
- Can be used for dry or wet applications due to polyester backing
- Ideal for use in medium duty applications
- For high initial cut on non-ferrous and soft-loading materials such as glass, titanium, masonry, composites, plastic and rubber

NON FERR.
STONE, GLASS 

	WxL (mm)	GRIT	PK QTY	ART NO.	PRICE
	100x2000	60	10	69957355675	£000.00
		80	10	69957355677	£000.00
		120	10	69957355681	£000.00
	100x3350	60	10	63642546593	£000.00
		80	10	63642546594	£000.00
		100	10	63642530703	£000.00
		120	10	63642546597	£000.00
		150	10	63642546599	£000.00
		180	10	63642546600	£000.00
		220	10	63642546602	£000.00
		240	10	63642546603	£000.00
		400	10	63642546616	£000.00

MADE-TO-ORDER PRODUCT AVAILABILITY

CAP CODE	GRAIN / GRIT	24	36	40	60	80	100	120	150	180	220	240	280	320	400
Viking R996	New SG supersize, YY/Y-polyester	•	•	•	•	•									
RED-X R976	SG supersize, X-polyester		•	•	•	•	•	•							
SG R929	SG, X-polyester		•	•	•	•	•	•							
Norax *	Special multi-layer abrasive														
H231*	Aluminium oxide, F-paper		•	•	•	•	•	•	•		•	•	•	•	•
R874	NZ, YY-polyester	•	•	•	•	•	•	•							
Norzon R822	Norzon, X-cotton	•	•	•	•	•	•	•	•						
Blue Force R872 *	New NZ, Y/X-polyester	•	•	•	•	•	•	•	•		•				
W445	SiC/cork, X-cotton														
R445	Silicon carbide, X/Y-polyester				•	•	•	•	•		•				
R293	Blend aluminium oxide, X/Y-polyester	•	•	•	•	•	•	•	•		•	•	•	•	•

MINIMUM ORDER QUANTITIES FOR MADE-TO-ORDER PRODUCTS

SIZE (mm)	LENGTH (mm) 750 - 1999mm	LENGTH (mm) > 2000mm
Up to 50mm	40 pieces	40 pieces
51 up to 100mm	30 pieces	30 pieces
Over 101mm	20 pieces	10 pieces



RAPID PREP BELTS

Norton non-woven belts are a combination of strong synthetic mesh and quality abrasive, bonded together by a smear-resistant adhesive. The open construction of non-woven material enables aggressive cutting action and improved surface finish while maintaining its non-loading feature. Ideal product to provide a great finish or remove burrs without gouging or undercutting the work piece.

PRODUCT SELECTION GUIDE

					
	EXTRA COARSE	COARSE	MEDIUM	FINE	VERY FINE
Scale removal	●				
Stock removal		●			
Heavy deburring		●			
Light deburring			●		
Light finishing			●		
Blending				●	
Finishing					●

PRODUCT OVERVIEW

APPLICATIONS

- Removing surface defects
- Light edge burrs
- Parting lines, flashing
- Rust, oxides & corrosion
- Paints and scale
- Blending mill marks
- Tool marks
- Uneven edges
- Applying decorative finishes

MACHINE USED

- File belt sander
- Portable sander
- Backstand machine

ABRASIVE GRAIN

- Vortex engineered aluminum oxide
- Aluminium oxide

GRIT RANGE

- Extra coarse
- Coarse
- Medium
- Fine
- Very fine

RAPID PREP BELT MATERIAL AVAILABLE IN TWO SPECIFICATIONS:

XF

Offers good flexibility for file belt applications



RF

Reinforced low-stretch backing for large narrow belt applications



AND IN TWO GRAIN TYPES

VORTEX RAPID PREP A/O



Better choice for finishing and blending applications



- Vortex engineered grain technology combines the cutting speed of coarse grits with the finish of fine grits
- Durable product for blending, finishing, cleaning, and light deburring
- Most consistent cutting and finishing surface conditioning products on the market
- Clean Bond technology - smear free, does not load on aluminium or soft metals
- Achieve a burr-free, paintable finish in fewer steps without damaging the base material
- Friable grain structure keeps Ra specs throughout belt life and reduces scrap & rework

RAPID PREP A/O



Good choice for finishing and blending applications



- General purpose product for blending, finishing, cleaning, and light deburring
- Achieve a burr-free, paintable finish in fewer steps without damaging the base material

RAPID PREP A/O XF SURFACE BLENDING FILE BELTS



	WxL (mm)	GRADE	CAP CODE	PK QTY	ART NO.	PRICE
	6x457	Coarse	S2238	20	63642535959	£000.00
		Medium	S2338	20	63642535963	£000.00
		Fine	S2438	20	63642536140	£000.00
		Very fine	S2538	20	66623333511	£000.00
	13x457	Coarse	S2238	20	63642535980	£000.00
		Medium	S2338	20	63642536113	£000.00
		Fine	S2438	20	63642536141	£000.00
		Very fine	S2538	20	66261055311	£000.00
	19x457	Coarse	S2238	20	63642536114	£000.00
		Medium	S2338	20	63642536116	£000.00
		Fine	S2438	20	63642536142	£000.00
		Very fine	S2538	20	66261003622	£000.00
	6x610	Coarse	S2238	20	63642536118	£000.00
		Medium	S2338	20	63642536121	£000.00
		Fine	S2438	20	63642536144	£000.00
		Very fine	S2538	20	66623333512	£000.00
	13x610	Coarse	S2238	20	63642536122	£000.00
		Medium	S2338	20	63642536129	£000.00
		Fine	S2438	20	63642536145	£000.00
		Very fine	S2538	20	66261019876	£000.00
	13x305	Coarse	S2238	20	63642536134	£000.00
		Medium	S2338	20	63642536137	£000.00
		Fine	S2438	20	63642536164	£000.00
		Very fine	S2538	20	66254499884	£000.00

Dimensions Key: W = Width, L = Length

BELTS BY DIMENSION

RAPID PREP A/O RF SURFACE BLENDING NARROW BELTS



WxL (mm)	GRADE	CAP CODE	PK QTY	ART NO.	PRICE
50x2000	Coarse	S2228	5	63642531724	£000.00
	Medium	S2328	5	63642531726	£000.00
	Fine	S2428	5	63642531732	£000.00
	Very fine	S2528	5	63642531733	£000.00
75x2000	Coarse	S2228	5	63642531735	£000.00
	Medium	S2328	5	63642531741	£000.00
	Fine	S2428	5	63642531743	£000.00
	Very fine	S2528	5	63642531751	£000.00
100x3500	Coarse	S2228	5	63642531760	£000.00
	Medium	S2328	5	63642531761	£000.00
	Fine	S2428	5	63642531764	£000.00
	Very fine	S2528	5	63642531784	£000.00
150x2000	Coarse	S2228	5	63642531787	£000.00
	Medium	S2328	5	63642531813	£000.00
	Fine	S2428	5	63642531816	£000.00
	Very fine	S2528	5	63642531819	£000.00

Dimensions Key: W = Width, L = Length

More sizes available on a Made-to-order

VORTEX RAPID PREP RF SURFACE BLENDING NARROW BELTS MADE-TO-ORDER



WxL (mm)	GRADE	CAP CODE	INFORMATION
Various belt sizes	Extra Coarse	S2123	More information available on request
	Coarse	S2223	
	Medium	S2323	
	Fine	S2423	
	Very fine	S2523	



GRIT	CAP CODE	PK QTY	ART NO.	PRICE	
6x457mm					
40	R929	10	66261123531	£000.00	+++++
60	R929	10	66261123532	£000.00	+++++
80	R929	10	66261123533	£000.00	+++++
120	R929	10	66261123535	£000.00	+++++
6x520mm					
40	R929	10	66261123543	£000.00	+++++
60	R929	10	66261123545	£000.00	+++++
80	R929	10	66261123546	£000.00	+++++
120	R929	10	66261123547	£000.00	+++++
9x533mm					
40	R996	10	66261128510	£000.00	+++++
	R929	10	66261123552	£000.00	+++++
	R293	10	66254470284	£000.00	+++
60	R996	10	66261128511	£000.00	+++++
	R929	10	66261123553	£000.00	+++++
	R293	10	63642508840	£000.00	+++
80	R996	10	66261128512	£000.00	+++++
	R929	10	66261123554	£000.00	+++++
	R293	10	66254470277	£000.00	+++
120	R929	10	66261123555	£000.00	+++++
	R293	10	66254470279	£000.00	+++
10x330mm					
40	R929	10	66623303110	£000.00	+++++
	R822	10	66261144347	£000.00	++++
	R230	10	69957385707	£000.00	+++
60	R929	10	66261144369	£000.00	+++++
	R822	10	66261144348	£000.00	++++
	R230	10	66261114049	£000.00	+++
80	R929	10	66623303270	£000.00	+++++
	R822	10	66261144349	£000.00	++++
	R230	10	63642515415	£000.00	+++
120	R929	10	66623303271	£000.00	+++++
	R822	10	66261144350	£000.00	++++
	R230	10	69957380686	£000.00	+++
13x305mm					
40	R929	10	66261194353	£000.00	+++++
	R822	10	66261194351	£000.00	++++
60	R929	10	66261023616	£000.00	+++++
	R822	10	63642552143	£000.00	++++
80	R929	10	66261023617	£000.00	+++++
	R822	10	63642524376	£000.00	++++
120	R929	10	66261023618	£000.00	+++++
	R822	10	69957308462	£000.00	++++
13x457mm					
40	R996	10	66261128495	£000.00	+++++
	R929	10	66261123522	£000.00	+++++
	R822	10	66261141253	£000.00	++++
60	R996	10	66261128498	£000.00	+++++
	R929	10	66261123523	£000.00	+++++
	R822	10	66261141254	£000.00	++++
80	R996	10	66261128499	£000.00	+++++
	R929	10	66261123524	£000.00	+++++
	R822	10	66261141255	£000.00	++++
120	R929	10	66261123525	£000.00	+++++
	R822	10	66261141256	£000.00	++++
13x610mm					
40	R929	10	66261123636	£000.00	+++++
	R822	10	66261141257	£000.00	++++
	R293	10	66623394060	£000.00	+++

GRIT	CAP CODE	PK QTY	ART NO.	PRICE		
13x610mm continued						
60	R929	10	66261123638	£000.00	+++++	
	R822	10	63642539830	£000.00	++++	
	R293	10	66254469666	£000.00	+++	
80	R929	10	66261123639	£000.00	+++++	
	R822	10	66261141260	£000.00	++++	
	R293	10	66623399824	£000.00	+++	
120	R929	10	66261123640	£000.00	+++++	
	R822	10	66261141261	£000.00	++++	
15x475mm						
40	R996	10	66261128521	£000.00	+++++	
	R929	10	66261123646	£000.00	+++++	
	R822	10	66261141262	£000.00	++++	
60	R293	10	63642548466	£000.00	+++	
	R996	10	66261128522	£000.00	+++++	
	R929	10	66261123647	£000.00	+++++	
80	R822	10	66261141263	£000.00	++++	
	R445	50	63642547214	£000.00	+++	
	R293	10	63642548527	£000.00	+++	
	R996	10	66261128523	£000.00	+++++	
	R929	10	66261123648	£000.00	+++++	
120	R822	10	66261141264	£000.00	++++	
	R445	50	63642539677	£000.00	+++	
	R929	10	66261123649	£000.00	+++++	
	R822	10	66261141265	£000.00	++++	
R445	50	63642539678	£000.00	+++		
	19x457mm					
	40	R996	10	66254480433	£000.00	+++++
R929		10	66254487679	£000.00	+++++	
R822		10	66623330766	£000.00	++++	
60	R996	10	66254408250	£000.00	+++++	
	R929	10	66254480427	£000.00	+++++	
	R822	10	63642539828	£000.00	++++	
80	R996	10	66254471640	£000.00	+++++	
	R929	10	66254481839	£000.00	+++++	
	R822	10	63642539836	£000.00	++++	
120	R929	10	66254481840	£000.00	+++++	
	R822	10	63642539843	£000.00	++++	
20x520mm						
40	R929	10	66623303272	£000.00	+++++	
	R822	10	66261141266	£000.00	++++	
	R293	10	69957380369	£000.00	+++	
	R230	10	69957396131	£000.00	+++	
	R929	10	66261029755	£000.00	+++++	
60	R822	10	66261141267	£000.00	++++	
	R445	50	66254425393	£000.00	+++	
	R293	10	69957377467	£000.00	+++	
	R230	10	66261034453	£000.00	+++	
	R929	10	66623303275	£000.00	+++++	
	R822	10	66261141269	£000.00	++++	
	R445	50	63642567304	£000.00	+++	
80	R293	10	66623385919	£000.00	+++	
	R230	10	66261106250	£000.00	+++	
	R929	10	66623303276	£000.00	+++++	
	R822	10	66261141270	£000.00	++++	
120	R445	50	63642547790	£000.00	+++	
	R293	10	63642513153	£000.00	+++	
	R230	10	66623327675	£000.00	+++	

BELTS BY DIMENSION

GRIT	CAP CODE	PK QTY	ART NO.	PRICE	
30x533mm					
24	R817	50	69957383624	£000.00	++++
36	R817	50	63642571575	£000.00	++++
40	R822	10	63642538962	£000.00	++++
	R817	50	63642556322	£000.00	++++
	R230	10	63642546483	£000.00	+++
60	R822	10	63642538963	£000.00	++++
	R445	50	63642519009	£000.00	+++
	R230	10	63642546477	£000.00	+++
80	R822	10	63642538964	£000.00	++++
	R445	50	69957379493	£000.00	+++
	R230	10	63642546478	£000.00	+++
120	R445	50	69957371884	£000.00	+++
	R230	10	63642546482	£000.00	+++
34x435mm					
24	R817	50	63642545273	£000.00	++++
36	R817	50	63642568989	£000.00	++++
40	R817	50	63642549470	£000.00	++++
	R230	10	77696076121	£000.00	+++
60	R230	10	63642550019	£000.00	+++
80	R230	10	63642549933	£000.00	+++
35x440mm					
40	R822	10	77696087694	£000.00	++++
60	R822	10	66261032676	£000.00	++++
80	R822	10	63642510293	£000.00	++++
120	R822	10	77696087695	£000.00	++++
50x800mm					
60	R929	10	66261023832	£000.00	+++++
80	R929	10	66261023833	£000.00	+++++
120	R929	10	66261023834	£000.00	+++++
75x457mm					
40	R230	10	63642538877	£000.00	+++
60	R230	10	63642539426	£000.00	+++
80	R230	10	63642539422	£000.00	+++
120	R230	10	63642539415	£000.00	+++
75x533mm					
40	R230	10	63642546289	£000.00	+++
60	R230	10	63642546257	£000.00	+++
80	R230	10	63642534248	£000.00	+++
100	R230	10	63642546273	£000.00	+++
120	R230	10	63642530701	£000.00	+++
75x610mm					
40	R230	10	63642546472	£000.00	+++
60	R230	10	63642546473	£000.00	+++
80	R230	10	63642567329	£000.00	+++
100	R230	10	63642545869	£000.00	+++
120	R230	10	63642546476	£000.00	+++
100x610mm					
40	R230	10	63642546295	£000.00	+++
60	R230	10	63642560145	£000.00	+++
80	R230	10	63642529798	£000.00	+++
100	R230	10	63642546242	£000.00	+++
120	R230	10	63642529797	£000.00	+++
100x620mm					
40	R230	10	63642546457	£000.00	+++
60	R230	10	63642534465	£000.00	+++
80	R230	10	63642529799	£000.00	+++
100	R230	10	63642534770	£000.00	+++
120	R230	10	63642546452	£000.00	+++

GRIT	CAP CODE	PK QTY	ART NO.	PRICE		
100x690mm						
40	R230	10	63642537627	£000.00	+++	
60	R230	10	63642537544	£000.00	+++	
80	R230	10	63642537546	£000.00	+++	
100	R230	10	63642537548	£000.00	+++	
120	R230	10	63642537632	£000.00	+++	
200x750mm						
24	R230	10	63642521182	£000.00	+++	
36	R817	10	63642515116	£000.00	++++	
	R230	10	69957349006	£000.00	+++	
40	R817	10	69957355996	£000.00	++++	
	R230	10	69957349007	£000.00	+++	
60	R817	10	69957371516	£000.00	++++	
	R230	10	69957349010	£000.00	+++	
80	R817	10	69957371517	£000.00	++++	
	R230	10	69957349014	£000.00	+++	
100	R817	10	66261182174	£000.00	++++	
	R230	10	69957349394	£000.00	+++	
120	R817	10	69957371513	£000.00	++++	
50x1600mm						
40	R929	10	66261023879	£000.00	+++++	
50	R929	10	66261023880	£000.00	+++++	
60	R929	10	66261023881	£000.00	+++++	
80	R929	10	66261023882	£000.00	+++++	
50x2000mm						
24	R996	10	69957364731	£000.00	+++++	
	R874	10	66623342805	£000.00	+++++	
36	R996	10	66254403822	£000.00	+++++	
	R929	10	69957350787	£000.00	+++++	
	R976	10	66623381099	£000.00	+++++	
	R822	10	63642546222	£000.00	++++	
40	R293	10	63642546943	£000.00	+++	
	R996	10	66254403847	£000.00	+++++	
	R976	10	66623328023	£000.00	+++++	
60	R929	10	69957350790	£000.00	+++++	
	R874	10	66623337486	£000.00	++++	
	R822	10	63642547270	£000.00	++++	
	R293	10	63642551489	£000.00	+++	
	R929	10	69957350792	£000.00	+++++	
80	R996	10	66254411262	£000.00	+++++	
	R976	10	66254401458	£000.00	+++++	
	R929	10	69957350793	£000.00	+++++	
	R874	10	66623312376	£000.00	++++	
	R822	10	63642546210	£000.00	++++	
	R293	10	63642546878	£000.00	+++	
	R996	10	66254449025	£000.00	+++++	
	R976	10	66261108229	£000.00	+++++	
	R929	10	69957350794	£000.00	+++++	
	R874	10	66623337488	£000.00	++++	
120	R822	10	63642546212	£000.00	++++	
	R976	10	66254408387	£000.00	+++++	
	R929	10	69957350795	£000.00	+++++	
	R874	10	66623312377	£000.00	++++	
50x2500mm	R822	10	63642516010	£000.00	++++	
	24	R996	10	69957364732	£000.00	+++++
	36	R996	10	66261099222	£000.00	+++++
R976		10	66254410572	£000.00	+++++	

GRIT	CAP CODE	PK QTY	ART NO.	PRICE	
50x2500mm continued					
40	R996	10	66254408229	£000.00	+++++
	R976	10	66261051186	£000.00	+++++
60	R996	10	66254416129	£000.00	+++++
	R976	10	66261063897	£000.00	+++++
80	R996	10	66254448015	£000.00	+++++
	R976	10	66254401374	£000.00	+++++
120	R976	10	66261107250	£000.00	+++++
50x3500mm					
24	R996	10	69957364733	£000.00	+++++
36	R996	10	66254404039	£000.00	+++++
	R976	10	66254409222	£000.00	+++++
40	R996	10	66254404041	£000.00	+++++
	R976	10	66623385396	£000.00	+++++
60	R996	10	66254436885	£000.00	+++++
	R976	10	66261071965	£000.00	+++++
80	R996	10	66254456931	£000.00	+++++
	R976	10	66254436884	£000.00	+++++
120	R976	10	66254411405	£000.00	+++++
50x4000mm					
24	R996	10	69957300743	£000.00	+++++
36	R996	10	66254404064	£000.00	+++++
	R976	10	66261055060	£000.00	+++++
	R293	10	63642539981	£000.00	+++
40	R996	10	66254404065	£000.00	+++++
	R976	10	66261092227	£000.00	+++++
	R293	10	63642539982	£000.00	+++
60	R996	10	66254405015	£000.00	+++++
	R976	10	66261054920	£000.00	+++++
	R293	10	63642539985	£000.00	+++
80	R996	10	66254444896	£000.00	+++++
	R976	10	66254401290	£000.00	+++++
	R293	10	63642539986	£000.00	+++
120	R976	10	66254474052	£000.00	+++++
75x2000mm					
24	R996	10	69957364735	£000.00	+++++
	R874	10	66623301373	£000.00	++++
	R822	10	63642539088	£000.00	++++
36	R996	10	66254410065	£000.00	+++++
	R929	10	69957350796	£000.00	+++++
	R976	10	66623319745	£000.00	+++++
	R874	10	66623314617	£000.00	++++
	R822	10	63642539386	£000.00	++++
40	R293	10	63642547942	£000.00	+++
	R996	10	66254407955	£000.00	+++++
	R976	10	66623301373	£000.00	+++++
	R929	10	69957350797	£000.00	+++++
	R874	10	66623307514	£000.00	++++
50	R822	10	63642539388	£000.00	++++
	R293	10	63642564728	£000.00	+++
	R929	10	69957350798	£000.00	+++++
	R822	10	63642538998	£000.00	++++
	60	R996	10	66254407954	£000.00
R976		10	66261060879	£000.00	+++++
R929		10	69957350799	£000.00	+++++
R874		10	66623307515	£000.00	++++
R822		10	63642539389	£000.00	++++
R293		10	63642548528	£000.00	+++

GRIT	CAP CODE	PK QTY	ART NO.	PRICE		
75x2000mm continued						
80	R996	10	66254456158	£000.00	+++++	
	R976	10	66254403117	£000.00	+++++	
100	R929	10	69957350800	£000.00	+++++	
	R874	10	66623307023	£000.00	++++	
120	R822	10	63642538999	£000.00	++++	
	R293	10	63642548275	£000.00	+++	
100	R929	10	66261024222	£000.00	+++++	
	120	R976	10	66254404255	£000.00	+++++
		R929	10	69957350801	£000.00	+++++
120	R874	10	66623307958	£000.00	++++	
	R822	10	63642539002	£000.00	++++	
	75x2500mm					
24	R996	10	69957364736	£000.00	+++++	
36	R996	10	66254403849	£000.00	+++++	
	R929	10	69957350882	£000.00	+++++	
	R976	10	66261066499	£000.00	+++++	
40	R874	10	66623327524	£000.00	++++	
	R822	10	63642546092	£000.00	++++	
	R293	10	63642546130	£000.00	+++	
	40	R996	10	66254403887	£000.00	+++++
		R976	10	66254402279	£000.00	+++++
50	R929	10	69957350883	£000.00	+++++	
	R874	10	66623302265	£000.00	++++	
	R822	10	63642546094	£000.00	++++	
	R293	10	63642546874	£000.00	+++	
	50	R929	10	69957350884	£000.00	+++++
60	R996	10	66254403891	£000.00	+++++	
	R976	10	66254433345	£000.00	+++++	
	R929	10	69957350888	£000.00	+++++	
	R874	10	66623303466	£000.00	++++	
	R822	10	63642546097	£000.00	++++	
80	R293	10	63642551507	£000.00	+++	
	R996	10	66254469059	£000.00	+++++	
	R976	10	66254407537	£000.00	+++++	
	R929	10	69957350898	£000.00	+++++	
	R874	10	66623328229	£000.00	++++	
120	R822	10	63642546099	£000.00	++++	
	R976	10	66254407535	£000.00	+++++	
	R929	10	66261023977	£000.00	+++++	
R874	10	66623304426	£000.00	++++		
100x920mm						
36	R822	10	63642546226	£000.00	++++	
40	R822	10	63642539330	£000.00	++++	
	R293	10	63642548306	£000.00	+++	
50	R822	10	63642539328	£000.00	++++	
60	R822	10	63642546216	£000.00	++++	
	R293	10	63642548307	£000.00	+++	
80	R822	10	63642546214	£000.00	+++	
	R293	10	63642551544	£000.00	+++	
100	R822	10	63642539383	£000.00	++++	
	R293	10	63642551546	£000.00	+++	
120	R293	10	63642551547	£000.00	+++	
180	R293	10	63642551549	£000.00	+++	

COATED ABRASIVES

BELTS BY DIMENSION

GRIT	CAP CODE	PK QTY	ART NO.	PRICE	
100x1000mm					
40	R929	10	69957350903	£000.00	+++++
	R822	10	63642547284	£000.00	++++
50	R929	10	69957350905	£000.00	+++++
	R822	10	63642538971	£000.00	++++
60	R929	10	69957350906	£000.00	+++++
	R822	10	63642538973	£000.00	++++
80	R822	10	63642538975	£000.00	++++
100	R822	10	63642538977	£000.00	++++
120	R822	10	63642536388	£000.00	++++
100x2000mm					
36	R929	10	69957350802	£000.00	+++++
40	R929	10	69957350804	£000.00	+++++
60	R929	10	69957350805	£000.00	+++++
	R445	10	69957355675	£000.00	+++
80	R929	10	69957350806	£000.00	+++++
	R445	10	69957355677	£000.00	+++
120	R929	10	69957350807	£000.00	+++++
	R445	10	69957355681	£000.00	+++
*	W445	10	63642580818	£000.00	++++
100x3000mm					
40	R293	10	63642551511	£000.00	+++
60	R293	10	63642548447	£000.00	+++
100x3350mm					
60	R445	10	63642546593	£000.00	+++
80	R445	10	63642546594	£000.00	+++
100	R445	10	63642530703	£000.00	+++
120	R445	10	63642546597	£000.00	+++
150	R445	10	63642546599	£000.00	+++
180	R445	10	63642546600	£000.00	+++
220	R445	10	63642546602	£000.00	+++
240	R445	10	63642546603	£000.00	+++
400	R445	10	63642546616	£000.00	+++
*	W445	10	63642545206	£000.00	++++
140x3300mm					
*	W445	10	66254415118	£000.00	++++
150x2000mm					
36	R822	10	63642539008	£000.00	++++
36	R929	10	69957350809	£000.00	+++++
40	R822	10	63642539010	£000.00	++++
40	R929	10	69957350812	£000.00	+++++
60	R929	10	69957350813	£000.00	+++++
60	R822	10	63642539014	£000.00	++++
80	R929	10	69957350815	£000.00	+++++
80	R822	10	63642539016	£000.00	++++
150x2500mm					
40	R929	10	66261023984	£000.00	+++++
60	R929	10	66261023992	£000.00	+++++
80	R929	10	66261023993	£000.00	+++++

*No abrasive grain

RAPID PREP BELTS

GRIT	CAP CODE	PK QTY	ART NO.	PRICE	
6x457mm					
Coarse	S2238	20	63642535959	£000.00	+++
Medium	S2338	20	63642535963	£000.00	+++
Fine	S2438	20	63642536140	£000.00	+++
Very Fine	S2538	20	66623333511	£000.00	+++
6x610mm					
Coarse	S2238	20	63642536118	£000.00	+++
Medium	S2338	20	63642536121	£000.00	+++
Fine	S2438	20	63642536144	£000.00	+++
Very Fine	S2538	20	66623333512	£000.00	+++
13x305mm					
Coarse	S2238	20	63642536134	£000.00	+++
Medium	S2338	20	63642536137	£000.00	+++
Fine	S2438	20	63642536164	£000.00	+++
Very Fine	S2538	20	66254499884	£000.00	+++
13x457mm					
Coarse	S2238	20	63642535980	£000.00	+++
Medium	S2338	20	63642536113	£000.00	+++
Fine	S2438	20	63642536141	£000.00	+++
Very Fine	S2538	20	66261055311	£000.00	+++
13x610mm					
Coarse	S2238	20	63642536122	£000.00	+++
Medium	S2338	20	63642536129	£000.00	+++
Fine	S2438	20	63642536145	£000.00	+++
Very Fine	S2538	20	66261019876	£000.00	+++
19x457mm					
Coarse	S2238	20	63642536114	£000.00	+++
Medium	S2338	20	63642536116	£000.00	+++
Fine	S2438	20	63642536142	£000.00	+++
Very Fine	S2538	20	66261003622	£000.00	+++
50x2000mm					
Coarse	S2228	5	63642531724	£000.00	+++
Medium	S2328	5	63642531726	£000.00	+++
Fine	S2428	5	63642531732	£000.00	+++
Very Fine	S2528	5	63642531733	£000.00	+++
75x2000mm					
Coarse	S2228	5	63642531735	£000.00	+++
Medium	S2328	5	63642531741	£000.00	+++
Fine	S2428	5	63642531743	£000.00	+++
Very Fine	S2528	5	63642531751	£000.00	+++
100x3500mm					
Coarse	S2228	5	63642531760	£000.00	+++
Medium	S2328	5	63642531761	£000.00	+++
Fine	S2428	5	63642531764	£000.00	+++
Very Fine	S2528	5	63642531784	£000.00	+++
150x2000mm					
Coarse	S2228	5	63642531787	£000.00	+++
Medium	S2328	5	63642531813	£000.00	+++
Fine	S2428	5	63642531816	£000.00	+++
Very Fine	S2528	5	63642531819	£000.00	+++



NORTON

SAINT-GOBAIN

COATED

SPECIALTIES

Spirabands and Cones	200
Cartridge and Spiral rolls	204
Sanding stars	208

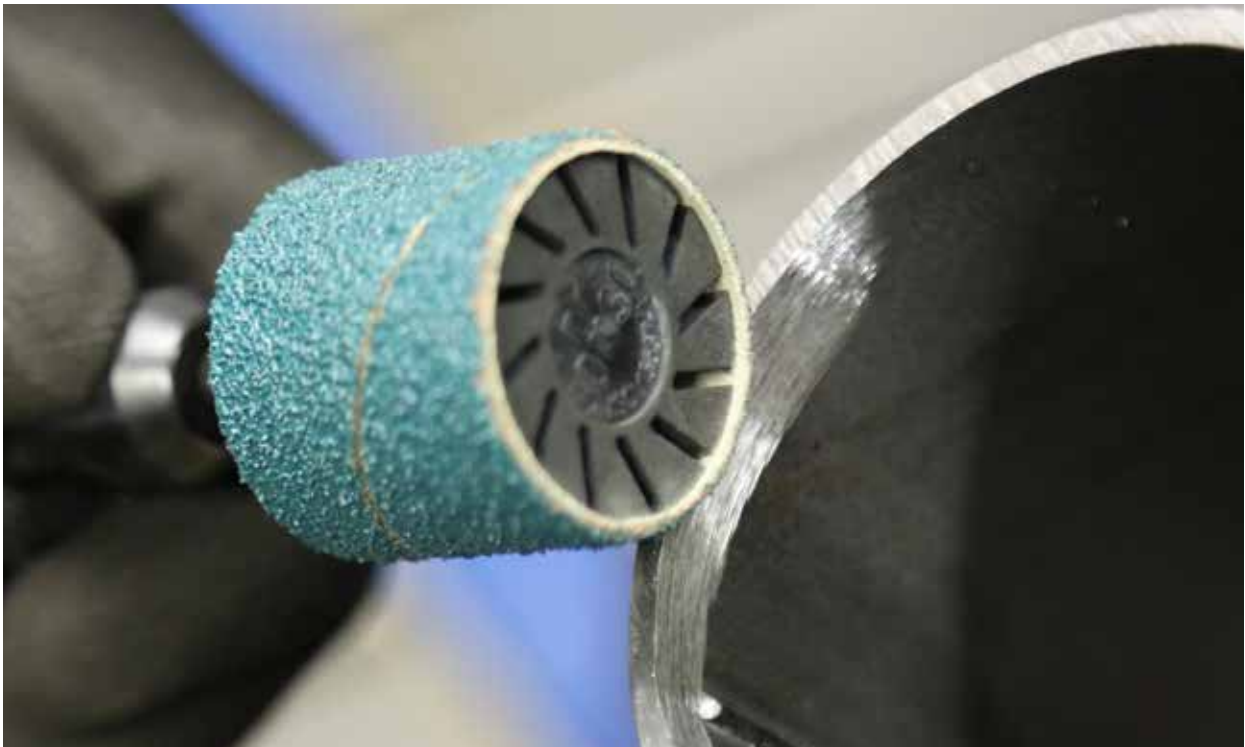

SPIRABANDS & CONES FOR DIE GRINDERS

Both abrasive spirabands and cones are unique shapes designed to access hard to reach areas including internal diameters, edges, surfaces curves and contours of components. They are ideal for removing parting lines, imperfections and burrs on surfaces and post-processing and repair work on metal structures, achieving high stock removal thanks to premium grain and exceptional product life even under the most demanding operating conditions. The spiral construction avoids shadow marks and provides smooth, chatter-free cutting action. Easy to mount and remove from cylindrical rubber mandrel by turning slightly to the right.

Spirabands & cones perform best at a recommended speed of 20-30m/s to optimize stock removal and surface finish whilst avoiding thermal load of the workpiece and tool wear.

PRODUCT SELECTION GUIDE

Highly recommended ●
Recommended ◐

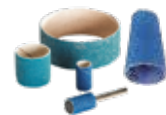

MATERIALS	BLAZE R920	X-TREME R822
	+++++	++++
Stainless steel, inox & duplex	●	◐
Inconel, titanium & super alloys	●	◐
Carbon steel, construction steel & mild steel	●	●
Cast iron	◐	●
Non-ferrous metal (brass/aluminium)		◐
Hard & soft wood		●

BLAZE R920 **+++++**

- The best choice on stainless steel, inconels, chromium cobalt, titanium and extremely hard materials
- Maximum performance helps achieve the lowest overall grinding cost on the most difficult-to-grind materials
- Premium Ceramic alumina grain provides longer life versus any other spiraband on stainless, titanium and super alloys
- Works well in heavy duty applications for maximum stock removal, reduced heat, loading and glazing

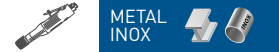

	DIM DIAxW (mm)	GRIT	PK QTY	ART NO.	RECOMMENDED SPEED (RPM)	MANDREL CODE	PRICE
ABRASIVE SPIRABANDS							
	15x30	36	100	66261137086	25000 - 31500	7660705182	£000.00
		60	100	66623331569			£000.00
		80	100	66623331571			£000.00
	22x20	36	100	66254402665	17500 - 21000	63642562578	£000.00
		60	100	66261192992			£000.00
		80	100	66623330997			£000.00
	25x25	36	100	66261137090	15300 - 19000	7660705183	£000.00
		60	100	66623331005			£000.00
		80	100	66623331007			£000.00
	30x30	36	100	66261137092	12700 - 15800	7660707918	£000.00
		60	100	66254493572			£000.00
		80	100	63642504970			£000.00
45x30	36	100	66254402667	9250 - 10500	7660705196	£000.00	
	60	100	66261031600			£000.00	
	80	100	66623331020			£000.00	
60x30	36	100	66261137185	6500 - 7900	7660717631	£000.00	
	60	100	66261137186			£000.00	
	80	100	66261137187			£000.00	

Dimensions Key: DIM = Dimensions, DIA = Diameter, W = Width

X-TREME R822 **++++**

- A great choice for carbon steel and welds
- Prevents loading on aluminum
- Zirconia abrasive provides an aggressive cut and long life on carbon steel and welds
- Ideal for use on irregular shaped components such as curves, or recesses



	DIM DIAxW (mm)	GRIT	PK QTY	ART NO.	RECOMMENDED SPEED (RPM)	MANDREL CODE	PRICE
ABRASIVE SPIRABANDS							
	13x25	36	100	66261176616	29400 - 36500	7660705185	£000.00
		50	100	63642528507			£000.00
		60	100	66261032722			£000.00
		80	100	63642528508			£000.00
	15x30	36	100	66261034127	25000 - 31500	7660705182	£000.00
		50	100	63642528509			£000.00
		60	100	66623386740			£000.00
		80	100	63642528496			£000.00

SPIRABANDS & CONES FOR DIE GRINDERS

	DIM DIAxW (mm)	GRIT	PK QTY	ART NO.	RECOMMENDED SPEED (RPM)	MANDREL CODE	PRICE
ABRASIVE SPIRABANDS							
	22x20	36	100	63642539865	17500 - 21000	63642562578	£000.00
		50	100	63642528497			£000.00
		60	100	63642539866			£000.00
		80	100	63642539867			£000.00
	25x25	36	100	63642528510	15300 - 19000	7660705183	£000.00
		50	100	63642528511			£000.00
		60	100	66623316384			£000.00
		80	100	63642528512			£000.00
	30x30	36	100	63642566870	12700 - 15800	7660707918	£000.00
		50	100	63642535053			£000.00
		60	100	63642545925			£000.00
		80	100	63642545926			£000.00
	38x25	36	100	66261180965	10000 - 12500	7660717568	£000.00
		50	100	66261180966			£000.00
		60	100	66261137836			£000.00
		80	100	66261180967			£000.00
45x30	36	100	63642528498	9250 - 10500	7660705196	£000.00	
	50	100	63642528514			£000.00	
	60	100	63642545928			£000.00	
	80	100	63642528515			£000.00	
51x25	36	100	63642528516	7500 - 9300	7660705184	£000.00	
	50	100	66261180974			£000.00	
	60	100	66261137837			£000.00	
	80	100	63642528518			£000.00	
60x30	36	100	63642536541	6500 - 7900	7660717631	£000.00	
	50	100	63642539765			£000.00	
	60	100	63642539874			£000.00	
	80	100	63642539766			£000.00	

	DIM DBxDTxH (mm)	GRIT	PK QTY	ART NO.	RECOMMENDED SPEED (RPM)	MANDREL CODE	PRICE
ABRASIVE CONES							
	20x14x63	36	100	66261176761	25000 - 31500	7660740439	£000.00
		50	100	66261176657			£000.00
		80	100	66261176656			£000.00
		120	100	66261176540			£000.00
	36x22x60	36	100	63642520987	15300 - 19000	7660740441	£000.00
		50	100	63642536572			£000.00
		80	100	63642545922			£000.00
		120	100	66261176703			£000.00

Dimensions Key: DIM = Dimensions, DB = Base diameter, DT = Top diameter, H = Height

ACCESSORIES

- Rubber expanding mandrel gives a forgiving finish,
- Mandrel diameter 6mm
- Easy to mount and remove spiraband from serrated rubber holder by turning slightly to the right,



FERR. & NON FERR. 

	DIM DBxDTH (mm)	PK QTY	ART NO.	PRICE
SPIRABAND MANDRELS				
	10x2x6	1	7660717573	£000.00
	13x25x6	1	7660705185	£000.00
	15x30x6	1	7660705182	£000.00
	22x20x6	1	63642562578	£000.00
	25x25x6	1	7660705183	£000.00
	30x30x6	1	7660707918	£000.00
	38x25x6	1	7660717568	£000.00
	45x30x6	1	7660705196	£000.00
	51x25x6	1	7660705184	£000.00
	60x30x6	1	7660717631	£000.00

	DIM DxWxS (mm)	PK QTY	ART NO.	PRICE
SPIRABAND MANDRELS				
	20x14x63	1	7660740439	£000.00
	36x22x60	1	7660740441	£000.00

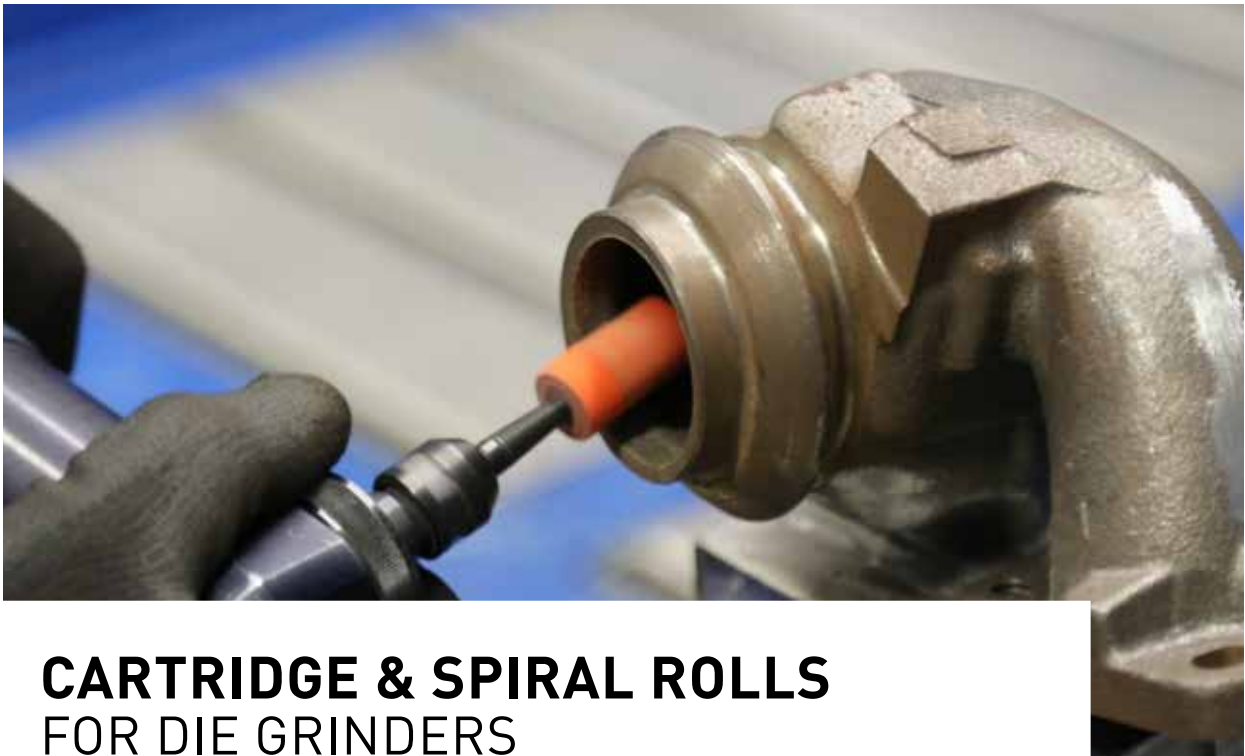

CARTRIDGE & SPIRAL ROLLS FOR DIE GRINDERS

Cartridge rolls are excellent for getting into small spaces, intricate areas and inside surfaces and corners where other abrasive shapes cannot reach. The abrasive cloth is rolled and glued to form a solid shape with abrasive grain on all sides. As the products are used, the grain fractures during use and reveals the next layer of abrasive, continually renewing the cutting edge. Typically, cartridge rolls are used on high-speed air grinders mounted on a mandrel for flash removal, polishing, or removing machine tool marks, edge breaking and dressing fillet weld seams on metal structures.

High speed air grinders are compact and lightweight for using mandrel-mounted abrasives, allowing better control than larger die grinders, they're a 'must' for any detail work on small parts. Cartridge and spiral rolls perform best at a recommended speed of 6-9 m/s to optimize stock removal and surface finish whilst avoiding thermal load of the workpiece and tool wear.

PRODUCT SELECTION GUIDE

Highly recommended ●
Recommended ◐



MATERIALS	BLAZE R920	X-TREME S R422	BDX R265
	+++++	++++	+++
Stainless steel, inox & duplex	●		
Inconel, titanium & super alloys	●		
Carbon steel, construction steel & mild steel	●		◐
Cast iron	◐		●
Non-ferrous metal (brass/aluminium)		◐	●
Hard & soft wood		●	◐
Composite materials		●	◐
Stone, concrete		●	
Glass, plastic		●	

SHAPE RECOMMENDATION GUIDE

STRAIGHT ZPE

Straight rolls wear to the shape required. Effective for:

- Flash removal
- Polishing or removing machine tool marks
- Edge breaking
- Reaching into corners, where larger diameter tools cannot work

All cartridge rolls are resin bond, half-glued.

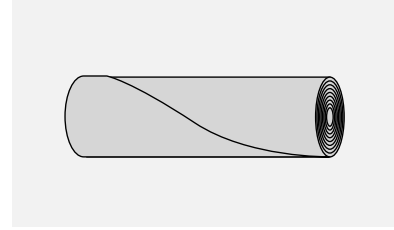

SPIRAL ZSPI

Spiral rolls are suited for use on contoured parts. Effective for:

- Grinding/polishing of channels, fillets and radii, and deburring small holes
- Tapered end can be used when the area to finish is hard to reach with a full cartridge roll
- Conforms to small areas
- Fits into irregular concaves, contours, channels

All spiral rolls are fully tapered, resin bonded, half glued.

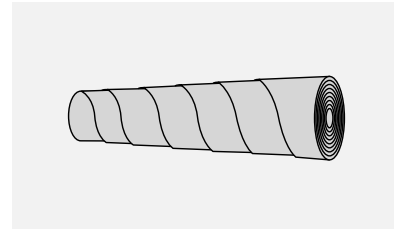

BLAZE R920

- Ceramic alumina grain for the highest productivity of all rolls, with faster cut rate and long life
- Grinding aid provides a cooler cut and reduced loading and glazing on hard to grind materials stainless steel, cobalt, inconel and titanium
- Improved bond system retains the grain for longer, helping you get more use from just one product
- Strong backing provides excellent durability even under tough pressure and wears evenly



	DIM BSxLxB (mm)	GRIT	PK QTY	ART NO.	RECOMMENDED SPEED (RPM)	MANDREL CODE	PRICE
STRAIGHT ZPE							
	6x25x3	120	50	66261128994	19000 - 28600	63642556790	£000.00
	6x38x3	80	50	66261128986	19000 - 28600	63642556791	£000.00
		120	50	66261128995			£000.00
	10x38x3	60	50	66261128973	11500 - 17200	63642556791	£000.00
		80	50	66261128988			£000.00
		120	50	66261128997			£000.00
	13x25x3	80	50	66261128989	8800 - 13200	63642556790	£000.00
		120	50	66261128998			£000.00
	13x38x3	60	50	66261128975	8800 - 13200	63642556791	£000.00
		80	50	66261128990			£000.00
		120	50	66261128999			£000.00
	19x38x3	60	50	66261128984	6000 - 9000	63642556791	£000.00
		80	50	66261128992			£000.00
		120	50	66261129001			£000.00

Dimensions Key: DIM = Dimensions, BS = Base diameter, L = Length, B = Bore

CARTRIDGE & SPIRAL ROLLS FOR DIE GRINDERS

	DIM BSxLxB (mm)	GRIT	PK QTY	ART NO.	RECOMMENDED SPEED (RPM)	MANDREL CODE	PRICE
SPIRAL ZSPI							
	10x38x3	60	50	66261129486	11500 - 17200	63642556791	£000.00
		80	50	66261129493			£000.00
		120	50	66261129501			£000.00
	13x38x3	60	50	66261129489	8800 - 13200	63642556791	£000.00
		80	50	66261129496			£000.00
		120	50	66261129514			£000.00

X-TREME R422

- Sharp silicon carbide abrasive for high initial cut on non-ferrous and soft-loading materials such as titanium, masonry, composites, plastic and rubber
- Resin bond system holds the grain for longer, helping you get more use from just one product
- A great solution for grinding titanium and non-ferrous aircraft and engine parts
- Ideal solution for sanding and polishing channels, fillets, recesses, radii, small contours and the bottom of dead-end holes



NON
FERR.



STONE



HARD &
SOFT WOOD



GLASS
ARISING

	DIM BSxLxB (mm)	GRIT	PK QTY	ART NO.	RECOMMENDED SPEED (RPM)	MANDREL CODE	PRICE
STRAIGHT ZPE							
	13x25x3	60	50	66261129007	8800 - 13200	63642556790	£000.00
		80	50	66261129017			£000.00
	13x38x3	60	50	66261129008	8800 - 13200	63642556791	£000.00
		80	50	66261129018			£000.00
	19x38x3	60	50	66261129011	6000 - 9000	63642556791	£000.00
		80	50	66261129020			£000.00

Dimensions Key: DIM = Dimensions, BS = Base diameter, L = Length, B = Bore

	DIM BSxLxB (mm)	GRIT	PK QTY	ART NO.	RECOMMENDED SPEED (RPM)	MANDREL CODE	PRICE
SPIRAL ZSPI							
	10x25x3	60	50	66261129522	11500 - 17200	63642556790	£000.00
		80	50	66261129531			£000.00
		120	50	66261129543			£000.00
	10x38x3	60	50	66261129523	11500 - 17200	63642556791	£000.00
		80	50	66261129532			£000.00
		120	50	66261129544			£000.00
	13x38x3	60	50	66261129526	8800 - 13200	63642556791	£000.00
		80	50	66261129535			£000.00
		120	50	66261129547			£000.00

Dimensions Key: DIM = Dimensions, BS = Base diameter, L = Length, B = Bore

BDX R265

- A good choice for hard-to-grind materials that require an economical option or for multi-purpose applications
- Resin bond system ensures edge adhesion
- Aluminium oxide abrasive provides a good cut rate and good product life
- Runs cooler and more efficiently; ideal for grinding exotic alloys



FERR. & NON FERR.

	DIM BSxLxB (mm)	GRIT	PK QTY	ART NO.	RECOMMENDED SPEED (RPM)	MANDREL CODE	PRICE
STRAIGHT ZPE							
	6x38x3	60	50	66261128877	19000 - 28600	63642556791	£000.00
		80	50	66261128899			£000.00
		120	50	66261128909			£000.00
	10x38x3	60	50	66261128886	11500 - 17200	63642556791	£000.00
		80	50	66261128901			£000.00
		120	50	66261128912			£000.00
	13x38x3	60	50	66261128891	8800 - 13200	63642556791	£000.00
		80	50	66261128904			£000.00
		120	50	66261128914			£000.00

	DIM BSxLxB (mm)	GRIT	PK QTY	ART NO.	RECOMMENDED SPEED (RPM)	MANDREL CODE	PRICE
SPIRAL ZSPI							
	10x25x3	60	50	66261129105	11500 - 17200	63642556790	£000.00
		80	50	66261129112			£000.00
		120	50	66261129120			£000.00
	13x38x3	60	50	66261129109	8800 - 13200	63642556791	£000.00
		80	50	66261129117			£000.00
		120	50	66261129124			£000.00
	19x38x3	60	50	66261129110	6000 - 9000	63642556791	£000.00
		80	50	66261129118			£000.00
		120	50	66261129125			£000.00

Dimensions Key: DIM = Dimensions, BS = Base diameter, L = Length, B = Bore

STEEL MANDREL FOR CARTRIDGE ROLLS

DESCRIPTION	DIM DIAxL (mm)	SHAFT DIAMETER (mm)	PK QTY	ART. NO.	PRICE
Steel mandrel for cartridge rolls with a 6mm shaft	3x13	6mm	1	63642587120	£000.00
	3x19	6mm	1	63642556790	£000.00
	3x25	6mm	1	63642556791	£000.00
	3x38	6mm	1	66261138811	£000.00

Dimensions Key: DIM = Dimensions, DIA = Pilot diameter, L = Pilot length



SANDING STARS

Ideal for deburring & finishing difficult to access metal applications, irregular shaped components, holes, radi and grooves as small as 35mm as well as removing sharp edges which may cause manual handling problems on irregular or awkward sized components. The perfect tool for applications requiring a perfect 360° finish, ideal for irregular surfaces due to high flexibility and conformability. Sanding stars are a multi-layered abrasive tool that are rived together on a 6mm shaft.

Sanding stars perform best at a recommended speed of 15-25m/s for optimizing stock removal and surface finish whilst avoiding thermal load of the workpiece and tool wear.

PRODUCT SELECTION GUIDE SANDING STARS

Highly recommended ●
Recommended ●



MATERIALS	BLAZE R946 +++++
Stainless steel, inox & duplex	●
Inconel, titanium & super alloys	●
Carbon steel, construction steel & mild steel	●
Cast iron	●

BLAZE R946 **+++++**

- Cuts cooler and lasts longer on stainless steel, cobalt, inconel, titanium and other hard-to-grind materials
- Maximum performance for lowest overall grinding cost on your most difficult-to-grind materials
- Reduced heat, loading and glazing on stainless, titanium and super alloys
- Conforms to irregular shaped components and contours



	DIM DIAxS (mm)	GRIT	NUMBER OF PLYES	PK QTY	ART NO.	RECOMMENDED SPEED (RPM)	PRICE
	40x6	60	12	10	66261131904	7200 - 12000	£000.00
		120	12	10	66261132447		£000.00
	60x6	60	12	10	66261132442	4800 - 8000	£000.00
		120	12	10	66261132449		£000.00
	80x6	60	12	10	66261132444	3600 - 6000	£000.00
		120	12	10	66261132451		£000.00
100x6	60	12	10	66261132445	2900 - 4800	£000.00	
	120	12	10	66261132452		£000.00	

MADE-TO-ORDER PRODUCT AVAILABILITY

PRODUCT / GRIT	80	120	150	180	240	320
BLAZE R946	•	•	•	•	•	•
X-TREME S R427*	•	•	•	•	•	
BDX R309*	•	•	•	•	•	•

* available as MTO

MINIMUM ORDER QUANTITY

DIAMETER (mm)	MINIMUM ORDER QUANTITY
25	50 pieces
40	50 pieces
50	50 pieces
60	50 pieces
70	50 pieces
80	50 pieces
100	50 pieces
125	50 pieces



SAFETY ADVICE

GENERAL PRECAUTIONS

Safety instructions provided by the machine manufacturers must be followed. Where fitted, all guards, covers and hoods must be in place on the machine during grinding, and should not be modified in any way. Abrasives should not be used near inflammable material or in an environment where there is a risk of explosion.

Sparks should be directed away from the face and body, if possible towards the floor. Dust extraction equipment must be used whenever it is available. The instructions

for use given by the abrasive manufacturer must be followed e.g. 'Not to be used without a support', or 'Not to be used for wet grinding'. The workpiece must be firmly fixed before grinding starts. Check all abrasives visually before use and make certain that the product is suitable for the application. No modifications should be made to abrasive products after delivery.

When using a portable grinder always switch it off and allow the spindle to stop completely before putting the tool down.

TRANSPORT & STORAGE

All coated abrasives should be handled carefully. Damage can be caused by mishandling, which should be avoided. Coated abrasives should be stored in dry, frost free conditions. They should be kept away from heat sources, cold, damp walls, doors or windows and should not be in direct contact with the floor. Temperatures and humidity should be between 18°C and 22°C and 45%-65% relative humidity. Coated abrasives should not be exposed to direct sunlight. Products should be kept in their original packaging until immediately before use. Once unpacked, they should be stored in a way which avoids distortion.

Temperature and humidity are the two most important climatic factors influencing coated abrasive performance. Backings and adhesives are sensitive to climatic changes and will gain or lose moisture according to the relative humidity of their surroundings.

Excessive humidity may cause a softening of some types of adhesive bonds so that the product quickly fills and clogs, or loses its grain during use. Excessive dryness may cause brittleness, reduced flexibility, and distortion of product shapes.

As moisture in the coated abrasive product increases or decreases, dimensional changes can occur. When the backing changes more than the adhesive bond, it causes cupping.

High and low humidity can cause concave and convex cupping respectively. The newer synthetic-backed belts are not affected by moisture. Broad temperature swings will not permanently harm these products either, but cold temperatures will cause a "cold set" condition. Consequently, these products should be allowed to come to room temperature before use.

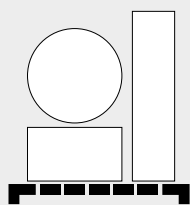

KEEP PRODUCTS IN ORIGINAL PACKAGING

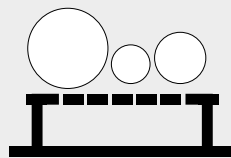

STORE BULK ROLLS FLAT

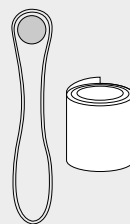

STORE BELTS PROPERLY

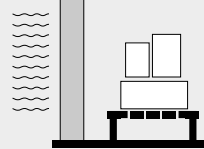

KEEP AWAY FROM HEAT / COLD SOURCES

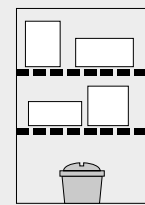

PRE-CONDITION BEFORE USE

- Keep products in original packages. These packages facilitate handling and can be stacked in the most practical and convenient manner.
- Bulk rolls should not be allowed to stand on edge after they have been unpacked. Store flat on shelves or pallets.
- Narrow belts which have been removed from the carton should be rolled up and stored on edge on a clean shelf. Belts may be draped over a large cylinder, such as a brake drum, or flanged hanger of the type used for a garden hose. Never hang a belt from a nail – the backing will crease and the abrasive belt might crack.

- Wide belts should be hung over a tube of at least 100mm diameter. Center the belt joint over the tube and add a light weight (such as old packaging tubes) to the bottom loop of the belt to aid in removing set.
- Condition for 24 hours prior to use.
- For maximum product efficiency, precondition coated abrasive products in a chamber of controlled temperature and humidity before use.

SAFETY ADVICE

For your safety you should ensure that you are fully aware of how to safely use abrasives

DO's

Read the safety instructions provided by the abrasives and equipment supplier
Store abrasives in dry, frost-free conditions avoiding wide variations in temperature
Ensure that the product is suitable for its purpose
Handle, store and transport products with care
Disconnect the power to the machine before fitting the product
Examine all products before mounting and periodically during use for possible defects or damage (core flatness, fatigue cracks, undercutting, arbor hole damage...)
Check that correct mounting devices are used and that they are clean, undistorted and free from burrs
Ensure that work rests are properly adjusted and secure
Always use a correctly designed and adjusted guard (on belts)
Ensure that the workpiece is secure
Wear appropriate personal protective equipment at all times
Avoid clogging and uneven wear to ensure that the product is working efficiently
Ensure accordance between product direction arrow / machine rotation
Ensure that all machines using abrasives meet the requirements of the current european machinery directives-CE
Be aware of the hazards likely during the use of abrasives and observe the recommended precautions to be taken: <ul style="list-style-type: none"> • Bodily contact with the abrasive product at operating speed • Injury resulting from product breakage during use • Grinding debris, sparks, fumes and dust generated by the grinding process • Noise • Vibration

DON'Ts

Allow untrained people to use abrasives
Use a product that is damaged
Use a product if it cannot be properly identified
Use a machine that is not in good working order or one with defective parts
Force the abrasive onto the mounting device or modify the size of the mounting hole
Exceed the maximum operating speed marked on the product
Apply shock or excessive force to the product or let it overheat
Use mounting flanges which are not clean and flat
Tighten the mounting device excessively
Start the machine until the guard is in place and fastened securely
Continue to use a product if vibration occurs. True or replace it
Grind on the part of the product which is not designed for the operation
Start the machine with the workpiece in contact with the abrasive product
Grind material for which the product is not designed
Stop the abrasive by applying pressure to its surface, let it stop naturally
Wear loose clothing, ties and jewellery
Use abrasive products near flammable materials

SAFETY ADVICE

PERSONAL PROTECTION

Safety goggles, ear defenders, safety gloves, dust masks and, if conditions are severe, additional face protection. Leather aprons and safety shoes must be worn.



Mouth
Protection



Wear
Gloves



Eye
Protection



Ear
Protection



Read
Instructions



Wet



Dry





NORTON

SAINT-GOBAIN®

BONDED
ABRASIVES

BONDED ABRASIVES

Introduction	214	DRESSING STICKS & SHARPENING STONES	261-270
PRECISION GRINDING	219-248	Dressing sticks	262
Straight wheels	224	Bench & combination oil stoness	264
Straight & tapered cups	242	Abrasive & precision files	266
Dishes	245	Abrasive slips and specialties	269
Cylinders	246	ORGANIC WHEELS & CUPS FOR SNAGGING	271-272
Segments	247	Snagging wheels	272
MOUNTED POINTS & WHEELS	249-260	Snagging cups	272
Vitrified mounted points	251	STRAIGHT CUT-OFF WHEELS	273-266
Organic mounted points	259	Non-Reinforced wheels	274
		Reinforced wheels	274

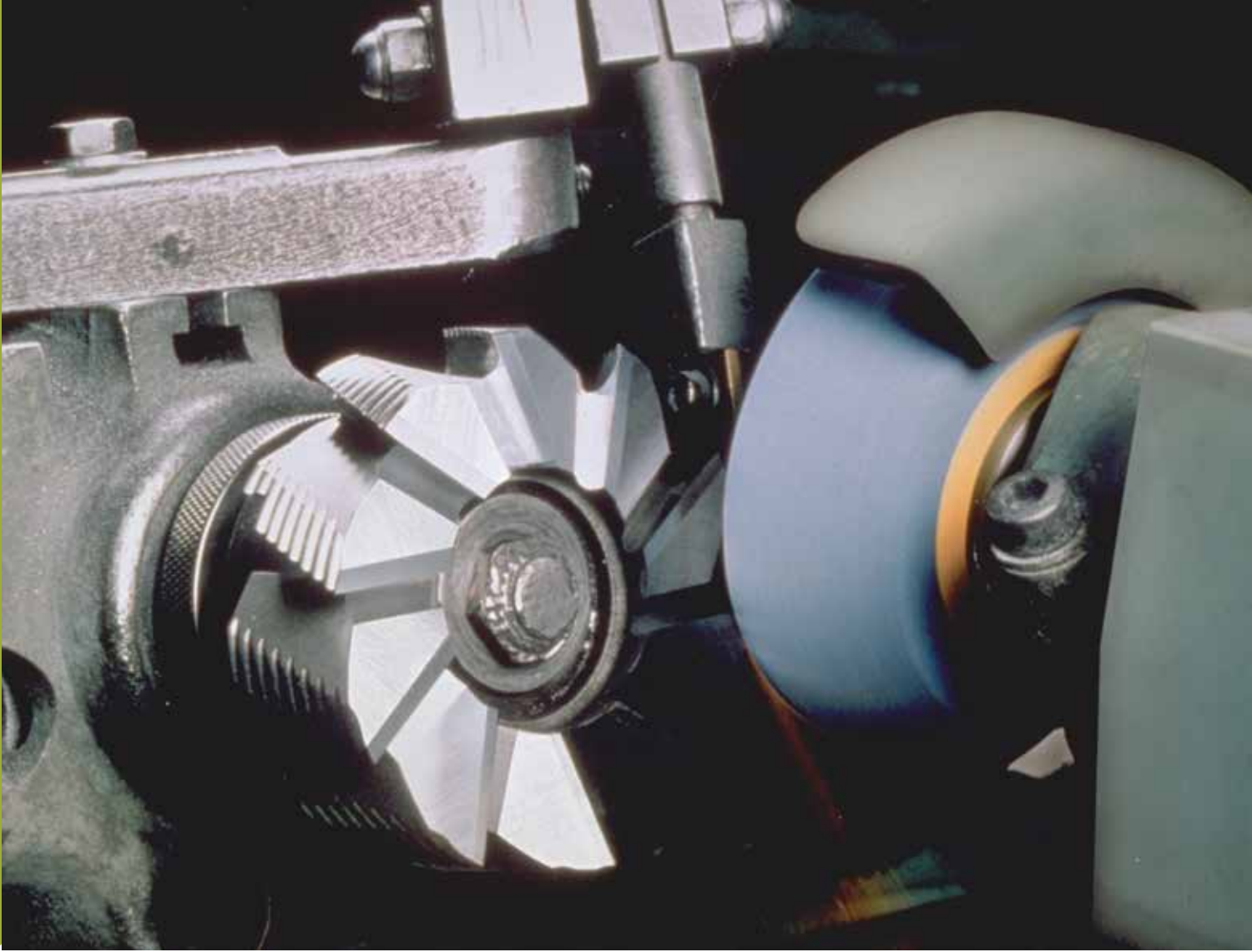

INTRODUCTION BONDED ABRASIVES

From standard aluminum oxide bench wheels to premium ceramic abrasive surface grinding wheels, Norton offers high performance abrasive solutions that can maximise productivity in virtually all industrial applications.

The extensive product range is designed to meet all your precision grinding and roughing application needs, with all the most appropriate abrasive specifications, including grinding wheels, segments, mounted points, dressing sticks and sharpening stones.

Norton, the industry's most comprehensive Bonded abrasive product line.

WHAT IS A GRINDING WHEEL?

A grinding wheel is a precision tool with thousands of cutting points. It consists of abrasive grains held in a matrix of bond and separated by pores. The abrasive grains are the cutting points while the purpose of the bond is to hold the individual grains together. The pores (hollow spaces between adjacent abrasive grains and the bond) serve to provide clearance for coolant penetration and metal chips removed in the grinding process.

When the wheel is rotated at grinding speed and applied to the workpiece, the abrasive grains cut the material that is being ground, removing the material in small chips.

Under the action of the forces imposed during grinding the abrasive cutting points are worn flat, resulting in the points becoming blunt. This causes an increase in friction, and a build up of heat.

The increase in grinding forces causes either the abrasive to fracture, exposing new cutting edges, or fractures the bond bridges holding the abrasive grains. In the latter case fresh abrasive grains are exposed to cut the workpiece.

In normal vitrified grinding applications the wheel has to be dressed.

By varying the properties of the abrasive, the type of bond, the make-up of the wheel, it is possible to produce grinding wheels with a vast range of different grinding characteristics.

ABRASIVE TYPES

CERAMIC ALUMINIUM OXIDE

Norton SG, Norton Quantum are patented ceramic forms of aluminium oxide that are harder and sharper than conventional abrasive grains.

The ceramic grain has a unique microcrystalline structure and when used in a grinding operation this microstructure becomes self-sharpening.

This leads to a reduction in the need for wheel dressing and a considerably cooler cutting action.

ALUMINIUM OXIDE

Generally recommended for grinding materials of high tensile strength, such as stainless steel and tool steels, but it can also be used on some high tensile aluminium and bronze alloys. It is manufactured in varying qualities.

SILICON CARBIDE

Harder than aluminium oxide with a very sharp abrasive grain shape. It is recommended for grinding relatively soft materials such as aluminium or cast iron as well as grinding extremely hard materials such as cemented carbide.

ZIRCONIA ALUMINA

For use in rough grinding applications where high stock removal is required. Associated with high tech resin bonds.

GRAIN SPECIFICATIONS

- A** This is a particularly tough form of aluminium oxide. Its toughness is due to the presence of 3% of titanium oxide in the abrasive. Fired at low temperature the abrasive retains its natural brown colour. Fired at high temperature further oxidation of the titanium oxide takes place which changes the normal brown colour to a grey-blue. Because of its toughness, regular brown alumina is suitable for grinding high tensile strength materials, specifically off-hand grinding (bench grinding wheels) & sharpening stones.
- 19A** A blend of A & 38A abrasives. This abrasive gives a grinding action that can be compared to the average of its components. It is supplied in some standard tool room wheels, used for surface, cylindrical, centreless & miscellaneous grinding on less heat sensitive steels.
- 38A** White fused aluminium oxide (99,8% pure). The most friable & cool cutting of the aluminium oxides. This abrasive is supplied in all types of standard range wheels ideal for use on hard & heat sensitive steels & alloys. It has traditionally been used for sharpening high-speed steel & cast alloy tools & cutters. 38A is used for cylindrical, surface & internal grinding of tools, dies & gauges.
- 57A** Semi-pure brown fused aluminium oxide (98% pure). The higher purity of 57A makes it a good general purpose abrasive. Its versatility enables it to be used for grinding steel parts in both soft & hard states, especially on large cylindrical & centreless operations. U Treatment (U57A) is a ceramic coating applied to this abrasive to increase its durability in resin bonded cutting-off wheels. It is used in the advanced range resinoid cut-off wheels.
- 86A** Pink aluminium oxide is a highly refined form of alumina containing a small proportion of chromium oxide. This addition makes 86A a little tougher than pure white, increasing the strength along the shear planes. This abrasive is available in a range of mounted points & wheels.
- SGB** A blend of premium abrasives that include a medium, high, very high concentration of premium abrasive SG.
- 3SG** SG has a unique microcrystalline structure allowing self-sharpening.
- 5SG**
- 2NQ** Blends that include medium, high, very high concentrations of premium abrasive NQ. NQ has improved self sharpening properties allowing even cooler grinding action vs. SG. NQ blends are specially suited for low to medium pressure applications.
- 3NQ**
- 4NQ**
- 5NQ**
- 37C** Crystolon silicon carbide abrasive. Supplied mainly in the resin bonds of advanced wheels used for grinding grey iron, non-ferrous metals & in vitrified bonds for grinding non-metallic materials, such as rubber & stone.
- 39C** Crystolon is the highest purity silicon carbide abrasive. It is ideal for grinding cemented carbide cutting tools, fired ceramics & glass, where it provides advanced performance.



GRIT SIZE

The number in the grinding wheel, marking designating grit size, represents the approximate number of openings per linear inch in the final screen size used to size the grain. The following rules should be followed:

USE COARSE GRIT

- For soft, ductile, stringy materials such as soft steel or aluminium
- For rapid stock removal
- Where finish is not important
- For large areas of contact.

USE FINE GRIT

- For hard, brittle materials such as hard tool steels, cemented carbides & glass
- For fine finishes
- For small areas of contact
- For holding small corner radii.

WHEEL GRADE

The grade indicates the relative holding power of the bond, which holds abrasive grains in a wheel. This is represented in the specification by letters running through the alphabet from softest to hardest. The following rules should be followed with regard to grade:

USE SOFT GRADE

- For hard materials such as hard tool steels & carbides
- For large areas of contact
- For rapid stock removal.

USE HARD GRADE

- For soft materials
- For small or narrow areas on contact
- For longer wheel life.

COMMON RANGE OF GRADES

F	G	H	I	J	K	L	M	N	O	P	Q	R	S	T	U
				CYLINDRICAL/CENTRELESS											
SURFACE GRINDING															
				ID GRINDING											
				TOOL GRINDING											
				THREAD GRINDING											
NON-REINFORCED ORGANIC															
										REINFORCED ORGANIC					

BOND TYPES-VITRIFIED

Vitrified bonds are the most common precision grinding bond. Porosity and strength of the wheels made with this bond give high stock removal along with their rigidity helping to attain high precision. Not affected by water, acid, oils or ordinary temperature variations.

THE MOST COMMON VITRIFIED BONDS ARE:

VS3 / VS3P

VITRIUM³ REVOLUTIONARY BOND TECHNOLOGY

The Vitrium³ bond platform features an exclusive chemistry that delivers an entirely new grain adhesion science, resulting in improved product versatility across a wide range of precision grinding applications. Provides cool cutting, precise profile, high speed, versatile across all precision grinding applications.

VS

VS is a versatile, low temperature, vitrified bond system used in most precision applications.

VX / VXP

Equivalent to VS bond, for ceramic only.

VQN / VQNP

These bonds are associated with Norton Quantum technology - a versatile technology for low, medium and high force applications.

BOND TYPES-ORGANIC

These bonds are used in two types of wheels. Firstly, wheels used on portable or fixed machines for the rapid removal of metal. Secondly, cutting-off wheels either un-reinforced or reinforced, for use on portable or fixed machines. The most common organic bonds are:

SNAGGING WHEELS & CUPS

B & B3 Foundry wheels: multi-purpose bond that gives satisfactory results on most applications

B28 Foundry wheels: high level bond suitable for most technical applications requiring high powered machines

CUTTING-OFF WHEELS

BFX Foundry X bond technology designed to increase cut rate and wheel life in all cut-off applications on a wide range of tough materials

BF1 Specific bond ensuring the best quality of cut in dry or wet conditions

BF3 New generation bond assuring the best wheel life in dry cutting operations; versatile & long wheel life. Ideal for heavy duty operations

B24 New generation bond used on silicon carbide cut-off wheels that gives the best performance & the ultimate cut quality on non-ferrous metals in wet conditions

B25 Standard multi-purpose bond that offers durability & freeness of cut in a wide variety of materials & applications. Can also be used in wet cutting on softer grades

B26 New generation bond used on aluminium oxide cut-off wheels that gives the best performance & the ultimate cut quality on ferrous metals in wet conditions

B65 Traditional bond gives good performance & long wheel life in dry cutting conditions

SELECTING THE RIGHT PRODUCT

THERE ARE NINE MAIN FACTORS TO BE CONSIDERED WHEN SELECTING A GRINDING WHEEL FOR ANY APPLICATION:

- The material to be ground – its type & hardness
- The stock to be removed
- The workpiece geometry & surface finishes required
- The grinding machine, the type of machine, the power available & its conditions
- Wheel speeds & feeds
- Grinding contact area
- Grinding fluid – whether the operation is wet or dry
- The severity of the grinding operation
- The dressing method

MATERIAL TO BE GROUND

The type of material affects the selection of abrasive, grit size and grade. Alumina type abrasives are the most suitable for grinding high tensile materials such as steel and ferritic cast irons. The more friable types of alumina are preferred on harder steels and applications having large arcs of contact.

Low tensile strength materials and non-metallic materials are most efficiently ground or cut with silicon carbide abrasive.

The hardness of the material governs the amount of penetration that can be achieved by the abrasive. For this reason finer grit size wheels are required to grind hard materials and soft materials are best ground with medium to coarse grit size wheels.

For most efficient operation, the grade must be adjusted to suit the hardness of the material. As a general guide, the harder the material, the softer the grade of wheel required.

STOCK TO BE REMOVED

This affects the choice of abrasive size and bond type.

High stock removal rates, as in fettling operations, require coarse grit wheels, typically 12 to 24 mesh.

Fine finishes and tight limits on finished workpiece geometry require finer grit sizes.

Final surface finish is often achieved by 'spark out'. No further infeed is applied and the wheel is allowed to grind until the majority of the grinding sparks cease.

SURFACE FINISH

SURFACE FINISH	FINISH	GRIT SIZE							
		46	60	80	100	120	150	180	220
42	1,10	●							
32	0,80	●							
26	0,70	●							
21	0,50		●						
16	0,40		●						
14	0,35		●	●					
11	0,25		●	●					
8	0,20			●	●				
7	0,17			●	●	●			
6	0,14				●	●	●		
5	0,12					●	●	●	
4	0,10						●	●	●
3	0,08							●	●
2	0,05								●
MIN FORM RADIUS	METIC [mm]	0,75	0,50	0,40	0,25	0,20	0,18	0,13	0,10
	IMP INS	,030	,020	,015	,010	,008	,007	,005	,004

The achievable surface finish in any grinding operation is highly dependent upon the grit size of the grinding wheel. The following chart shows the range of surface finishes achievable when using grinding wheels of different grit sizes on conventional precision grinding applications, together with the minimum form radius that can be ground using each grit size.

ACHIEVING IMPROVED SURFACE FINISHES

By changing the wheel dressing technique, it is possible to achieve finer surface finishes than those shown. As well as reducing the dresser infeed per revolution of the grinding wheel, it is also possible to reduce the infeed and traverse rate when grinding, thus reducing the stock removal rate. Obviously this approach will have limited application in production grinding but it can be very useful in tool room work.

Other factors can affect the surface finish achieved. In particular:

- Production grinding applications, with higher stock removal ranges, will give surface finishes at the coarser end of the range
- Plunge grinding applications will often require the selection of a grit size one size finer than shown
- Dressing techniques & the type of material can also affect the surface finish achieved

READING THE PRODUCT

- 1 Safety pictograms
- 2 Strong Norton branding
- 3 Product dimensions (mm)
- 4 Product specification
- 5 Maximum operating speed
- 6 Article number; for use when re-ordering
- 7 oSa certified
The Organisation for Safety of Abrasives
- 8 European safety standard EN 12413





NORTON

SAINT-GOBAIN®

BONDED
ABRASIVES

PRECISION GRINDING

Straight wheels	224
Straight & tapered cups	242
Dishes	245
Cylinders	246
Segments	247

PRECISION GRINDING APPLICATIONS

Thanks to Norton's technical expertise, bond and abrasive grain formulations are optimized to best suit the technical request of all precision operations. Our vitrified wheels are available in a variety of shapes, diameters and arbor

sizes available from stock or on request. They are intended to maximize your productivity by improving your grinding efficiency and part quality in surface, tool and cutter, ID and cylindrical grinding as well as sharpening applications.



TOOL GRINDING

Tool grinding refers to the maintenance and repair of the cutting tools used in manufacturing operations. Wheels of all sizes and shapes are used in tool and cutter applications. Most wheels used are vitrified, in grit sizes 36 to 220, and in grades H through to N.



SAW SHARPENING

Saw sharpening refers to the maintenance and repair of saw blades. Vitrified flat wheels and cups are used in grit sizes 54 to 60. Resin treatment reinforces the wheel and helps reduce wheel face deformation.



SURFACE GRINDING

The term surface grinding is used to describe the grinding of flat surfaces in which the wheel moves past the workpiece in a flat plane, or vice versa. Surface grinding applications range can vary from heavy rapid stock removal, to precision contour grinding.



EXTERNAL CYLINDRICAL GRINDING

Norton's leading technology, provides you with the best precision, formholding vitrified wheels to maximize productivity, increase grinding efficiency and improve part quality in all your external cylindrical grinding operations.



INTERNAL CYLINDRICAL GRINDING

Internal grinding refers to the grinding of bores or holes and is probably one of the most difficult types of grinding. Internal grinding applications range from very rapid stock removal to more controlled processes capable of generating sizes and concentricity measured in microns.



BENCH AND PEDESTAL GRINDING

Bench and pedestal grinding application refers to offhand deburring and sharpening of parts and tools. The wheels are mounted on bench grinders or pedestal grinders and covers three types of abrasives to answer all deburring, shaping and sharpening needs: aluminum oxide for high speed tool steels and other metals, and silicon carbide for non-ferrous metals.

REDUCTION RINGS

Plastic reduction rings may be used to adapt grinding wheels to fit on various spindle sizes. These rings reduce the bore hole size, allowing the wheel to be safely mounted on a spindle with a smaller diameter.

- Reduction rings should never come in contact with the flange
- Reduction rings should not be used on wheels of thicknesses less than 6mm, nor greater than 50mm
- Always use one reduction ring on each side of the wheel when the wheel is thick enough to allow correct seating
- Never use reduction rings to reduce the hole below the minimum specified in the FEPA safety code

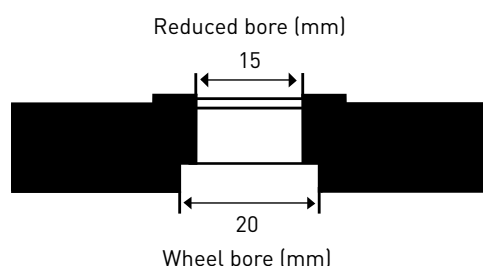

WHEEL BORE (mm)	REDUCED TO (mm)	ART NO.
50,8	35	7660704766
32	25	7660717540
32	20	7660717538
31,75	15,88	7660704757
31,75	12,7	7660704755
20	16	7660717530
20	15	7660717529
20	13	7660717527
20	12	7660717525
20	10	7660717524
16	6	510008919



NQ VS3

Engineered microcrystalline ceramic grain combined with our latest innovative bond

- A perfect blend of sharp grains for the ultimate free cutting action
- Enhanced bond adhesion and chemistry for a cooler cut and high speed material removal
- Unique, microcrystalline structure is self sharpening for long product life
- High profile accuracy and reduced dressing frequency



NQ



Engineered microcrystalline ceramic grain

- A perfect blend of sharp grains for the ultimate free cutting action
- Unique, microcrystalline structure is self sharpening for long product life
- Can be used in all low, medium and high force applications
- Reduces the need for dressing

SG VS3



An excellent ceramic grain with the latest bond innovation

- High concentration of SG ceramic aluminum oxide abrasive combined with our Vitrium³ enhanced bond adhesion and chemistry
- Unique, microcrystalline structure is self sharpening for long product life
- Ultimate cutting capability
- High material removal rate whilst maintaining a high profile accuracy for reduced dressing

3SG / 5SG



Traditional ceramic microstructure grain

- Very high concentration of SG ceramic aluminium oxide abrasive for high removal rate & extended wheel life
- Unique, microcrystalline structure is self sharpening for long product life
- Very good cutting capabilities on very hard steels
- Perfect for technical applications where grinding parameters can be adjusted to optimise performance



SGA / SGB



A blend with a low concentration of ceramic grain for good performance in a number of applications

- Harder & sharper than conventional abrasive grains for good cutting capabilities
- Very versatile for use on a number of steels
- Suitable for low to medium power machines



38A VS3



The latest bond innovation with conventional alumina grain

- High purity aluminium oxide abrasive for cool & burn free cutting
- Highly friable abrasive, versatile on hard metals (HRc >50)
- Ideal for heat sensitive applications with light to moderate feed rates
- Improved profile accuracy and wheel life

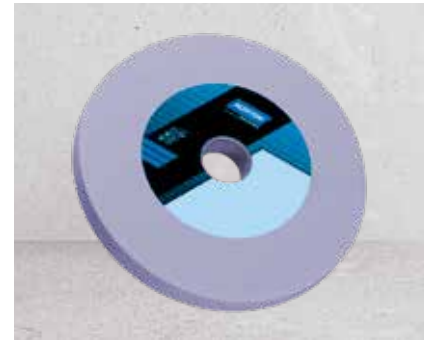

GF



A low concentration of ceramic grain with durable aluminium oxide grain

- Good performance on common soft and medium steels



38A



High purity aluminium oxide abrasive

- Friable grain renews sharp cutting edges for good product life
- Good cut rate and reduced heat generation on hardened or high-speed tool steels
- Ideal for heat-sensitive applications ideally in low/medium pressure applications
- Ideal for use on all steel hardnesses



19A



A blend of brown and white aluminium oxides for good price vs. performance ratio

- Combines cutting efficiency and wheel life
- Very versatile, can be used on a wide variety of steels
- Good yield, good removal rate
- Good balance between cut rate & form holding ability



32A



Semi-friable brown aluminium oxide

- Tough grain maintains sharp edges for good wheel life
- Good profile holding reduces dressing needs
- For use on the most common soft/medium steels



A +++

Brown aluminium oxide

- For soft steel removal, shaping and deburring
- Very tough, suitable for grinding most types of soft steels
- Good wheel life and hard wearing for general purpose cylindrical off-hand bench & pedestal grinding applications
- Good good price vs. performance ratio

39C +++

Highest purity green silicon carbide abrasive

- The most friable conventional abrasive grain. Harder & more friable than aluminium oxide abrasive
- For all general purpose bench and pedestal applications on non-ferrous materials and carbide tools.
- Ideal for high precision grinding & sharpening applications
- Good cut rate and finish on metal carbide & non-ferrous hard or heat sensitive materials

37C +++

High purity black silicon carbide abrasive

- Harder & more friable than aluminum oxide abrasive
- Suitable for roughing operations in coarse grit & resinoid wheels
- Ideal for grinding & sharpening applications on non-ferrous metals





STRAIGHT WHEELS FOR PRECISION GRINDING

PRODUCT RECOMMENDATION

Highly recommended ●
Recommended ○

DIM DxTxH (mm)	SHAPE	P	FA	FB	Recess/Inner concave Diameter	Recess/Concave Depth A	Recess/Concave Depth B	Tools	Saw Sharpening	Bench Wheels	Internal Diameter	External Diameter	Surface	High alloyed steels & HSS	Soft steels	Inox	Non-Ferrous & Carbide	Cast iron	SPECIFICATION	MOS (m/s)	ART. NO.	PRICE	PK QTY	QUALITY TIER
10x10x3,18	01	-	-	-										●	○				SGB 60 J VS3	63	66253355175	£00,00	10	++++
13x13x4	01	-	-	-										●	○	○			5NQ 80 K VS3	35	66253348357	£00,00	10	+++++
13x13x4,76	01	-	-	-										●	○				SGB 60 J VS3	63	66253355176	£00,00	10	++++
	05	6	6	-										●	○				SGB 60 J VS3	63	66253355177	£00,00	10	++++
16x16x6	01	-	-	-										●	○	○			5NQ 80 J VQN	45	66253244881	£00,00	10	+++++
	01	-	-	-										●	○	○			3NQ 60 K VS3	35	66253348360	£00,00	10	+++++
	01	-	-	-										●	○	○			3NQ 60 L VQN	45	66253261880	£00,00	10	+++++
	05	10	8	-										●	○	○			5NQ 60 K 8 VS3	35	66253348333	£00,00	10	+++++
20x20x6	05	13	10	-										●	○	○			5NQ 80 J VQN	45	66253244883	£00,00	10	+++++
	05	13	10	-										●	○	○			5NQ 60 K VS3	35	66253348335	£00,00	10	+++++
	05	13	10	-										●	○				SGB 60 K VX	45	69936681793	£00,00	10	++++
	01	-	-	-										●	○	○			38A 60 K VS3	45	66253348355	£00,00	10	++++
	01	-	-	-										●	○	○			3NQ 60 L VQN	45	66253261903	£00,00	10	+++++

Recess/Inner concave Diameter
 Recess/Concave Depth A
 Recess/Concave Depth B
 Tools
 Saw Sharpening
 Bench Wheels
 Internal Diameter
 External Diameter
 Surface
 High alloyed steels & HSS
 Soft steels
 Inox
 Non-Ferrous & Carbide
 Cast iron

GRAIN COLOUR CODE

- NQ
- NQ Vit³
- 38A
- 38A Vit³
- 32A
- GF
- 86A
- 25A
- 37C
- 39C
- A
- 19A
- SG

DIM DxDxH (mm)	SHAPE	P	FA	FB	Deburring & Sharpening	Grinding	Materials		SPECIFICATION	MOS (m/s)	ART. NO.	PRICE	PK QTY	QUALITY TIER
20x20x6,35	01	-	-	-				● ○	SGB 60 J 8 VS3	63	66253355179	€00.00	10	+++++
	05	10	10	-				● ○	SGB 60 J VS3	63	66253355181	€00.00	10	+++++
	05	10	10	-				● ○ ○	5NQ 60 K VQN	45	66253244884	€00.00	10	+++++
	05	10	10	-				● ○	38A 60 L VS	35	69936621542	€00.00	10	+++
25x25x6,35	05	13	12	-				● ○	SGB 60 J VS3	63	66253355182	€00.00	10	+++++
	05	13	12	-				● ○ ○	5NQ 80 I VQN	45	66253244885	€00.00	10	+++++
	05	13	12	-				● ○	38A 60 K VS3	45	66253348349	€00.00	10	+++++
25x25x8	05	13	10	-				● ○	SGB 60 K VX	45	69936681795	€00.00	10	+++++
	05	13	12	-				● ○ ○	5NQ 60 K VS3	35	66253348317	€00.00	10	+++++
	05	13	12	-				● ○	3SG 80 L VS	35	69936639647	€00.00	10	+++++
	05	13	10	-				● ○ ○	5NQ 80 J VQN	45	66253244887	€00.00	10	+++++
32x25x8	05	13	10	-				● ○ ○	5NQ 60 J VQN	45	66253244888	€00.00	10	+++++
32x32x8	05	16	16	-				● ○	5SG 60 K VS	35	69936639439	€00.00	10	+++++
32x32x9,53	05	16	16	-				● ○	SGB 60 J 8 VS3	63	66253355183	€00.00	10	+++++
	05	16	16	-				● ○ ○	5NQ 80 I VQN	45	66253244898	€00.00	10	+++++
32x32x10	05	16	16	-				● ○	SGB 60 J VX	45	69936676291	€00.00	10	+++++
	05	16	16	-				● ○	5SG 60 K VS	35	69936639605	€00.00	10	+++++
	05	16	16	-				● ○	38A 60 L VS	45	69936675118	€00.00	10	+++
40x25x9,53	05	20	12	-				● ○	SGB 60 J VS3	63	66253355184	€00.00	10	+++++
	05	20	12	-				● ○ ○	5NQ 60 K VQN	45	66253244889	€00.00	10	+++++
40x25x10	05	16	12	-				● ○	5SG 60 K VS	35	69936639834	€00.00	15	+++++
	05	16	12	-				● ○ ○	5NQ 80 K VQN	45	66253244890	€00.00	10	+++++
40x32x10	05	20	16	-				● ○ ○	5NQ 60 L VQN	45	66253244891	€00.00	10	+++++
40x40x10	05	16	20	-				● ○ ○	5NQ 60 K VQN	45	66253244897	€00.00	10	+++++
	05	16	20	-				● ○ ○	5NQ 60 J VS3	35	66253348334	€00.00	10	+++++
40x40x12,7	05	20	20	-				● ○	SGB 60 J VS3	63	66253355185	€00.00	10	+++++
50x40x12,7	05	25	20	-				● ○ ○	5NQ 60 K VQN	45	66253244892	€00.00	10	+++++
	05	25	20	-				● ○	SGB 60 J VS3	63	66253355186	€00.00	10	+++++
50x40x16	05	25	20	-				● ○ ○	5NQ 60 K VQN	45	66253244894	€00.00	10	+++++
	05	25	20	-				● ○ ○	5NQ 60 J VS3	35	66253348348	€00.00	10	+++++
	05	25	20	-				● ○	SGB 60 J VS3	63	66253355187	€00.00	10	+++++
63x10x20	01	-	-	-				● ○	38A 60 N VS	45	66253050376	€00.00	10	+++
63x40x12,7	05	32	20	-				● ○ ○	5NQ 80 I VQN	45	66253244895	€00.00	10	+++++
	05	32	20	-				● ○	SGB 60 J VS3	63	66253355187	€00.00	10	+++++
	05	32	20	-				● ○	38A 60 L VS	45	69936621565	€00.00	10	+++
70x7,1x17	01	-	-	-				● ○ ○	3NQ 60 L VS3	35	66253348329	€00.00	10	+++++
76x25x12,7	01	-	-	-				● ○	39C 80 I V	45	66253052726	€00.00	10	+++
76x32x20	05	42	16	-				● ○ ○	5NQ 60 J VQN	45	66253244896	€00.00	10	+++++
80x25x12,7	01	-	-	-				● ○	39C 60 M V	45	66253051624	€00.00	10	+++
80x25x13	01	-	-	-				● ○	37C 60 N V	35	69936668764	€00.00	10	+++
	01	-	-	-				● ○	39C 60 M V	45	66253051623	€00.00	10	+++
100x10x20	01	-	-	-	●			● ○	38A 60 M VS	35	69936640015	€00.00	5	+++

BONDED ABRASIVES FOR PRECISION GRINDING

PRODUCT RECOMMENDATION

Highly recommended ●
Recommended ○

DIM DxDxH (mm)	SHAPE	P	FA	FB	Recess/Inner concave Diameter		Recess/Concave Depth A		Recess/Concave Depth B		Tools	Saw Sharpening	Bench Wheels	Internal Diameter	External Diameter	Surface	High alloyed steels & HSS	Soft steels	Inox	Non-Ferrous & Carbide	Cast iron	SPECIFICATION	MOS (m/s)	ART. NO.	PRICE	PK QTY	QUALITY TIER	
100x10x32	01	-	-	-	●												○	●	●			39C 80 L VS	45	66253050380	€00.00	2	+++	
100x13x32	01	-	-	-	●												○	●				38A 60 L VS	45	66253050409	€00.00	1	+++	
100x20x32	01	-	-	-	●												○	●				38A 60 L VS	45	66253050413	€00.00	1	+++	
125x6x32	01	-	-	-	●	●											○	●				38A 60 L VS	45	66253050440	€00.00	2	+++	
125x10x32	01	-	-	-	●												○	●				38A 60 L VS	45	69936675731	€00.00	1	+++	
125x13x32	01	-	-	-	●												●	○				3SG 60 J VX	45	66253050290	€00.00	2	+++++	
125x16x32	01	-	-	-	●												○	●				38A 60 M VS	45	66253050237	€00.00	2	+++	
125x20x32	01	-	-	-	●													●	●			39C 80 L VS	45	66253050393	€00.00	2	+++	
	01	-	-	-	●							●						●	●			39C 60 K VS	45	66253338039 ⁺	€00.00	2	+++	
	01	-	-	-	●													●	●			39C 80 L VS	45	69936667443	€00.00	2	+++	
	01	-	-	-								●					○	●		○		38A 46 N VS	45	66253289920 ⁺	€00.00	2	+++	
	01	-	-	-								●						●				A 46 N VS	45	69936675558	€00.00	2	+++	
	01	-	-	-								●						●				A 60 N VS	45	69936666909	€00.00	2	+++	
	01	-	-	-								●						●	●			39C 80 K VS	45	66253338040 ⁺	€00.00	2	+++	
	01	-	-	-								●						●				A 60 N VS	45	66253289860 ⁺	€00.00	2	+++	
	01	-	-	-								●						●				A 46 N VS	45	66253289859 ⁺	€00.00	2	+++	
	01	-	-	-	●													○	●			38A 60 K VS	45	66253050620	€00.00	2	+++	
150x3x30	01	-	-	-													○	●				38A 60 N VS	45	66253338189 ⁺	€00.00	2	+++	
	01	-	-	-	●												○	●				38A 60 L VS	45	69936675736	€00.00	2	+++	
	01	-	-	-	●												○	●				38A 80 L VS3	50	66243541074	€00.00	5	+++++	
	01	-	-	-	●												○	●				38A 80 L VS3	50	66243541080	€00.00	5	+++++	
	01	-	-	-	●													●				19A 60 M VS	63	69936675941	€00.00	2	+++	
	150x4x20	01	-	-	-	●												○	●				38A 100 M VS	45	69936640219	€00.00	2	+++
		01	-	-	-	●												○	●				38A 80 L VS3	63	66243541077	€00.00	5	+++++
		01	-	-	-	●												○	●				38A 80 N VS	45	69936676720	€00.00	2	+++
		01	-	-	-	●												○	●				38A 60 L VS	45	69936675591	€00.00	1	+++
	150x4x30	01	-	-	-	●												○	●				38A 80 N VS	45	69936639730	€00.00	1	+++
150x4x32	01	-	-	-	●												●					19A 60 M VS	63	69936674920	€00.00	2	+++	
	01	-	-	-	●													●	●			39C 120 K VS	45	66253050248	€00.00	2	+++	
	01	-	-	-	●												○	●				38A 80 L VS3	63	66243541079	€00.00	5	+++++	
	01	-	-	-	●												●	○				SGB 80 K VS3	63	66243541066	€00.00	5	+++++	
	01	-	-	-	●												●					19A 60 O VS	63	69936675946	€00.00	2	+++	
150x6x31,75	01	-	-	-								●					○	●		○		38A 80 L VS	35	69936621582	€00.00	2	+++	
150x6x32	01	-	-	-	●												●					19A 60 M VS	63	69936675964	€00.00	2	+++	
	01	-	-	-	●												●	○				3SG 80 L VX	45	66253054873	€00.00	2	+++++	
	01	-	-	-	●												●	○				SGB 80 K VS3	63	66243541083	€00.00	5	+++++	
	01	-	-	-	●												●	○				3SG 60 L VX	45	66253055040	€00.00	2	+++++	
	01	-	-	-	●												●	○				SGB 60 K VS3	63	66243541070	€00.00	5	+++++	
	01	-	-	-	●												○	●				38A 60 L VS	35	69936675741	€00.00	2	+++	
	01	-	-	-	●														●				39C 120 K VS	45	69936675617	€00.00	2	+++

BONDED ABRASIVES



GRAIN COLOUR CODE

NQ	NQ Vit ³	A
38A	38A Vit ³	19A
32A	GF	SG
86A	25A	
37C	39C	

DIM DxDxH (mm)	SHAPE	P	FA	FB	Recess/Inner concave Diameter			Tools	Saw Sharpening	Bench Wheels	Internal Diameter	External Diameter	Surface	High alloyed steels & HSS	Soft steels	Inox	Non-Ferrous & Carbide	Cast iron	SPECIFICATION	MOS (m/s)	ART. NO.	PRICE	PK QTY	QUALITY TIER		
					Recess/Concave Depth A	Recess/Concave Depth B	Deburring & Sharpening																		Grinding	Materials
150x6x38	01	-	-	-				●						●	○				SGB 60 K VS3	63	66243541082	€00.00	5	++++		
150x8x32	01	-	-	-				●						●	○				3SG 60 J VX	45	66253055041	€00.00	2	++++		
	01	-	-	-				●						○	●				38A 120 J VS	45	69936675748	€00.00	2	+++		
	01	-	-	-				●						○	●				38A 60 L VS	45	69936675743	€00.00	2	+++		
150x10x32	01	-	-	-				●						○	●				38A 46 M VS	45	66253050261	€00.00	1	+++		
	01	-	-	-				●						○	●				SGB 60 K VS3	63	66243541072	€00.00	5	++++		
	01	-	-	-				●						○	●				38A 120 J VS	45	69936675749	€00.00	1	+++		
	01	-	-	-				●						○	●				38A 60 K VS	45	66253051070	€00.00	1	+++		
	01	-	-	-				●						○	●				3SG 60 L VX	45	66253050280	€00.00	2	++++		
	01	-	-	-				●						○	●	●	●			39C 80 K VS	45	66253050357	€00.00	2	+++	
	01	-	-	-				●						○	●				38A 60 L VS	45	69936675744	€00.00	1	+++		
	01	-	-	-				●						○	●				38A 100 M VS	45	66253050371	€00.00	1	+++		
	01	-	-	-				●						○	●	●	●			39C 120 K VS	45	69936675629	€00.00	2	+++	
	01	-	-	-				●						○	●					38A 80 M VS	45	66253050373	€00.00	2	+++	
	01	-	-	-				●						○	●					38A 60 M VS	45	69936641112	€00.00	1	+++	
	150x13x31,75	01	-	-	-				●						○	●				38A 60 K VS3	63	66253353664	€00.00	2	++++	
		01	-	-	-					●					○	●	●	●			39C 60 K VS	35	69936621564	€00.00	2	+++
		01	-	-	-						●				○	●	○			3SG 60 K VS	50	69936622862	€00.00	2	++++	
150x13x32	01	-	-	-				●						○	●				38A 60 L VS	35	69936675757	€00.00	1	+++		
	01	-	-	-				●						○	●				38A 46 L VS	45	69936675754	€00.00	2	+++		
	01	-	-	-				●						○	●				3SG 46 H VX	45	66253054863	€00.00	2	++++		
	01	-	-	-				●						○	●				38A 60 N VS	45	69936675758	€00.00	2	+++		
	01	-	-	-				●						○	●				38A 80 L VS	45	69936675759	€00.00	1	+++		
	01	-	-	-				●						○	●				38A 60 L VS	35	69936639340	€00.00	4	+++		
	01	-	-	-				●						○	●				3SG 60 L VX	45	66253050142	€00.00	2	++++		
	01	-	-	-				●						○	●				38A 120 J VS	45	69936675760	€00.00	2	+++		
	150x16x32	01	-	-	-				●						○	●				3SG 60 H 12 VXP	45	69936677177	€00.00	2	++++	
		01	-	-	-				●						○	●				38A 80 L VS	45	69936675767	€00.00	1	+++	
01		-	-	-				●						○	●				38A 60 L VS	45	69936675764	€00.00	2	+++		
01		-	-	-				●						○	●				38A 46 L VS	45	69936675763	€00.00	1	+++		
01		-	-	-				●						○	●	●	●			39C 80 L VS	45	69936675657	€00.00	2	+++	
01		-	-	-					●					○	●				A 46 N VS	45	69936675560	€00.00	2	+++		
01		-	-	-				●						○	●				3SG 60 L VX	45	66253050367	€00.00	2	++++		
01		-	-	-				●						○	●	●	●			39C 120 K VS	45	69936675659	€00.00	2	+++	
150x20x31,75	01	-	-	-					●					○	●	●	●			39C 100 K VS	35	69936623221	€00.00	2	+++	
	01	-	-	-						●				○	●				A 60 N VS	35	69936623470	€00.00	2	+++		
	01	-	-	-							●			○	●				A 60 N VS	35	69936623302	€00.00	5	+++		
	01	-	-	-				●						○	●				38A 60 K VS3	63	66253353966	€00.00	1	++++		
	01	-	-	-					●					○	●				A 46 N VS	35	69936623469 ⁺	€00.00	2	+++		
	01	-	-	-					●					○	●				A 46 N VS	35	69936623469	€00.00	2	+++		
	01	-	-	-						●				○	●	●	●			39C 60 K VS	35	69936623474	€00.00	2	+++	

BONDED ABRASIVES

BONDED ABRASIVES FOR PRECISION GRINDING

PRODUCT RECOMMENDATION

Highly recommended ●
Recommended ○

DIM DxTxH (mm)	SHAPE	P	FA	FB	Recess/Inner concave Diameter			Tools	Saw Sharpening	Bench Wheels	Internal Diameter	External Diameter	Surface	High alloyed steels & HSS	Soft steels	Inox	Non-Ferrous & Carbide	Cast iron	SPECIFICATION	MOS (m/s)	ART. NO.	PRICE	PK QTY	QUALITY TIER
					Recess/Concave Depth A	Recess/Concave Depth B	Deburring & Sharpening																	
150x20x32	01	-	-	-					●					●				A 36 P VS	45	69936641366	€00.00	2	+++	
	01	-	-	-					●					●				A 60 N VS	45	66253290208 [†]	€00.00	2	+++	
	01	-	-	-	●									●	○			SGB 100 J VX	45	66253049895	€00.00	2	++++	
	01	-	-	-					●							●	●	39C 80 K VS	45	66253338042 [†]	€00.00	2	+++	
	01	-	-	-					●						●			A 36 O VS	45	66253338141 [†]	€00.00	2	+++	
	01	-	-	-	●									○	●			38A 60 L VS	45	69936641391	€00.00	2	+++	
	01	-	-	-					●						●			A 46 N VS	45	69936641367 [†]	€00.00	2	+++	
	01	-	-	-	●									○	●			38A 100 J VS	45	66243570493	€00.00	2	+++	
	01	-	-	-	●									○	●			38A 80 K 6 VS	45	66253051067	€00.00	2	+++	
	01	-	-	-					●						●			A 46 N VS	45	66253289863 [†]	€00.00	2	+++	
	01	-	-	-	●									●	○			3SG 60 K VX	45	66253050155	€00.00	2	+++++	
	01	-	-	-					●					○	●			38A 46 N VS	45	66253338090 [†]	€00.00	2	+++	
	01	-	-	-	●										●	●		39C 80 L VS	45	69936641413	€00.00	2	+++	
	01	-	-	-	●									○	●			38A 60 K 5 VS	45	66253051065	€00.00	2	+++	
	01	-	-	-	●									○	●			38A 46 M VS	45	66253050372	€00.00	1	+++	
	01	-	-	-	●									○	●			38A 60 N VS	45	69936641392	€00.00	1	+++	
	01	-	-	-	●										●	●		39C 120 K VS	45	69936641414	€00.00	2	+++	
	01	-	-	-	●									○	●			38A 80 L VS	45	69936639416	€00.00	1	+++	
	01	-	-	-					●					○	●		○	38A 46 N VS	45	66253289922 [†]	€00.00	2	+++	
	01	-	-	-	●										●	●		39C 60 K VS	45	69936641411	€00.00	2	+++	
01	-	-	-					●						●	●		39C 60 K VS	45	66253338041 [†]	€00.00	2	+++		
01	-	-	-					●						●	●		39C 120 K VS	45	66253338191 [†]	€00.00	2	+++		
01	-	-	-					●						●			A 60 N VS	45	69936641368	€00.00	2	+++		
150x25x20	01	-	-	-				●						●	●		39C 80 K VS	35	69936641429	€00.00	4	+++		
150x25x32	01	-	-	-				●						●			A 36 Q VS	45	66253050265	€00.00	2	+++		
	01	-	-	-				●						●			A 36 P VS	45	69936666914	€00.00	2	+++		
	01	-	-	-	●								○	●			38A 60 M VS	45	66253050381	€00.00	2	+++		
	01	-	-	-	●										●	●	39C 80 K VS	45	66253050278	€00.00	2	+++		
	01	-	-	-					●						●		A 46 N VS	45	69936641370	€00.00	2	+++		
	01	-	-	-					●						●		A 60 N VS	45	66253290209 [†]	€00.00	2	+++		
	01	-	-	-	●									○	●		38A 60 K VS	45	66253050452	€00.00	2	+++		
	01	-	-	-	●										●	●	39C 120 K VS	45	69936675664	€00.00	2	+++		
150x25x32	01	-	-	-				●					○	●		○	38A 60 N VS	45	66253338092 [†]	€00.00	2	+++		
	01	-	-	-	●									●	●		39C 60 K VS	45	69936675661	€00.00	2	+++		
	01	-	-	-					●						●	●	39C 60 K VS	45	66253338044 [†]	€00.00	2	+++		
175x3x51	01	-	-	-				●					○	●			38A 60 L VS3	50	66243541075	€00.00	5	++++		
175x4x51	01	-	-	-	●									●			19A 60 M VS	63	66253052709	€00.00	6	+++		
175x6x51	01	-	-	-				●					○	●			38A 60 L VS3	63	66243541069	€00.00	5	++++		
180x6x31,75	01	-	-	-				●					○	●			38A 60 K VS3	63	66253353968	€00.00	2	++++		
	01	-	-	-				●					○	●			38A 46 K VS3	63	66253353969	€00.00	2	++++		

BONDED ABRASIVES



GRAIN COLOUR CODE

NQ	NQ Vit ³	A
38A	38A Vit ³	19A
32A	GF	SG
86A	25A	
37C	39C	

DIM DxDxH (mm)	SHAPE	P	FA	FB	Recess/Inner concave Diameter			Tools	Saw Sharpening	Bench Wheels	Internal Diameter	External Diameter	Surface	High alloyed steels & HSS	Soft steels	Inox	Non-Ferrous & Carbide	Cast iron	SPECIFICATION	MOS (m/s)	ART. NO.	PRICE	PK QTY	QUALITY TIER
					Recess/Concave Depth A	Recess/Concave Depth B	Deburring & Sharpening																	
180x6x32	01	-	-	-															3SG 120 K VS	35	69936676015	€00.00	2	+++++
	01	-	-	-															38A 60 L VS	45	69936675784	€00.00	2	+++
180x10x32	01	-	-	-															38A 80 J VS	45	69936675781	€00.00	1	+++
180x13x31,75	01	-	-	-															SGA 60 K VS	50	66253121997	€00.00	2	+++++
	01	-	-	-															SGB 70 H 12 VXP	50	69936623463	€00.00	2	+++++
	01	-	-	-															39C 100 J VS	35	69936623248	€00.00	2	+++
	01	-	-	-															SGB 46 K VX	50	69936623240	€00.00	2	+++++
	01	-	-	-															3SG 60 K VS	50	69936623231	€00.00	2	+++++
	01	-	-	-															38A 80 L VS	35	69936623239	€00.00	2	+++
	01	-	-	-															38A 60 J VS	35	69936623266	€00.00	2	+++
	01	-	-	-															3SG 46 K VS	50	69936623227	€00.00	2	+++++
	01	-	-	-															SGB 60 K VX	50	69936623255	€00.00	2	+++++
	01	-	-	-															38A 100 L VS	35	69936623220	€00.00	2	+++
	01	-	-	-															38A 46 K VS3	63	66253353972	€00.00	2	+++++
	01	-	-	-															3SG 100 J VS	50	69936623276	€00.00	2	+++++
	01	-	-	-															SGA 46 K VX	50	66253121996	€00.00	2	+++++
	01	-	-	-															38A 60 K VS3	63	66253353974	€00.00	2	+++++
	180x13x32	01	-	-	-															38A 46 J VS	35	69936623274	€00.00	2
01		-	-	-															38A 80 L VS	45	69936675801	€00.00	1	+++
01		-	-	-															38A 60 L VS	45	69936675797	€00.00	2	+++
01		-	-	-															3SG 80 J VX	45	66253054892	€00.00	2	+++++
01		-	-	-															3NQ 60 I VS3	35	66253348361	€00.00	2	+++++
01		-	-	-															SGB 60 J VX	45	69936639148	€00.00	2	+++++
01		-	-	-															38A 120 J VS	45	69936675802	€00.00	1	+++
01		-	-	-															2NQ 46 I VS3	45	66253348363	€00.00	2	+++++
180x16x32	01	-	-	-															3SG 120 J VX	45	66253054874	€00.00	2	+++++
	01	-	-	-															3SG 60 H 12 VXP	35	69936677179	€00.00	2	+++++
	01	-	-	-															38A 46 J VS	35	69936675806	€00.00	2	+++
	01	-	-	-															38A 60 K VS	45	66253050453	€00.00	1	+++
180x20x31,75	01	-	-	-															SGB 70 G 12 VXP	45	69936639169	€00.00	2	+++++
	01	-	-	-															39C 60 K VS	35	69936623477	€00.00	2	+++
	01	-	-	-															38A 46 L VS	35	69936623312	€00.00	2	+++
	05	100	6	-															3SG 60 J VS	35	69936639808	€00.00	2	+++++
	05	100	6	-															38A 60 J VS	35	69936640226	€00.00	2	+++
	01	-	-	-															3SG 46 K VS	50	69936623242	€00.00	2	+++++
	01	-	-	-															SGB 60 K VX	50	69936623480	€00.00	2	+++++
180x20x32	01	-	-	-															38A 60 L VS	35	69936623472	€00.00	2	+++
	01	-	-	-															A 60 N VS	45	66253338022 ⁺	€00.00	2	+++
	01	-	-	-															39C 60 K VS	45	69936641415	€00.00	2	+++
	01	-	-	-															A 46 N VS	45	66253338021 ⁺	€00.00	2	+++
01	-	-	-															39C 120 K VS	45	69936675666	€00.00	2	+++	

BONDED ABRASIVES FOR PRECISION GRINDING

BONDED ABRASIVES

PRODUCT RECOMMENDATION

Highly recommended ●
Recommended ○

DIM DxDxH (mm)	SHAPE	P	FA	FB	Recess/Inner concave Diameter			Tools	Saw Sharpening	Bench Wheels	Internal Diameter	External Diameter	Surface	High alloyed steels & HSS	Soft steels	Inox	Non-Ferrous & Carbide	Cast iron	SPECIFICATION	MOS (m/s)	ART. NO.	PRICE	PK QTY	QUALITY TIER	
					Recess/Concave Depth A	Recess/Concave Depth B	Deburring & Sharpening																		Grinding
180x20x32	01	-	-	-					●					○	●				38A 46 N VS	45	66253338093 [†]	€00.00	2	+++	
	01	-	-	-					●					○	●				38A 60 N VS	45	66253338094 [†]	€00.00	2	+++	
	01	-	-	-				●						○	●				38A 60 J VS	45	69936675810	€00.00	1	+++	
	01	-	-	-				●						●	○				SGB 60 H 10 VXP	45	69936639170	€00.00	2	++++	
	01	-	-	-					●							●	●		39C 60 K VS	45	66253338045 [†]	€00.00	2	+++	
	01	-	-	-					●							●	●		39C 80 K VS	45	66253338050 [†]	€00.00	2	+++	
	01	-	-	-					●							●	●		39C 120 K VS	45	66253338184 [†]	€00.00	2	+++	
	01	-	-	-				●								●	●		39C 80 L VS	45	69936676582	€00.00	2	+++	
	01	-	-	-					●						●	○	○		3SG 60 H 12 VXP	35	66243593654	€00.00	2	+++++	
	01	-	-	-					●							●			A 46 N VS	45	69936641372	€00.00	2	+++	
	01	-	-	-				●							●	○			SGB 46 H 10 VXP	45	69936638723	€00.00	2	++++	
	01	-	-	-				●							●	○			SGB 60 K VX	45	66253049878	€00.00	2	++++	
180x25x31,75	05	105	12	-					●					○	●				38A 60 J VS	35	69936621557	€00.00	2	+++	
	05	105	12	-					●					○	●				38A 46 J VS	35	69936621529	€00.00	2	+++	
	05	105	12	-				●						○	●				38A 60 K 6 VS3	63	66253354035	€00.00	2	++++	
	05	105	12	-					●					○	●				38A 60 L VS	35	69936621526	€00.00	2	+++	
	05	105	12	-				●						○	●				38A 46 K 6 VS3	63	66253354036	€00.00	2	++++	
	05	105	13	-					●					●	○				SGB 46 K VX	50	69936621605	€00.00	2	++++	
	05	105	13	-					●					●	○	○			3SG 46 K VS	50	69936621519	€00.00	2	+++++	
	05	105	13	-					●					●	○	○			3SG 60 K VS	50	69936621570	€00.00	2	+++++	
180x25x32	01	-	-	-					●						●				A 46 N VS	45	69936675564	€00.00	2	+++	
	01	-	-	-				●							●	●			39C 60 K VS	45	69936675667	€00.00	2	+++	
	01	-	-	-				●							●	●			39C 80 L VS	45	69936667101	€00.00	2	+++	
	01	-	-	-				●						○	●				38A 60 L VS	45	69936675812	€00.00	2	+++	
200x1,5x32	01	-	-	-				●					●	○					SGB 80 K 6 VS3	50	66253354585	€00.00	5	++++	
200x2x32	01	-	-	-				●					●	○					SGB 80 K 6 VS3	50	66253354586	€00.00	5	++++	
	01	-	-	-				●					○	●					38A 80 L VS3	50	66243541085	€00.00	5	++++	
200x2,5x32	01	-	-	-				●					●	○					SGB 80 K 6 VS3	50	66253354587	€00.00	5	++++	
200x3x32	01	-	-	-				●					○	●					38A 80 L VS3	50	66243541084	€00.00	5	++++	
	01	-	-	-				●					●	○					SGB 80 K 6 VS3	50	66253354588	€00.00	5	++++	
200x4x32	01	-	-	-				●					●	○					SGB 80 K VS3	63	66243541087	€00.00	5	++++	
	01	-	-	-				●						●					19A 60 O VS	63	69936675986	€00.00	6	+++	
200x6x20	01	-	-	-				●					○	●					38A 60 L VS3	63	66243541081	€00.00	5	++++	
200x6x31,75	01	-	-	-					●				○	●					38A 120 I VS	35	69936640156	€00.00	2	+++	
200x6x32	01	-	-	-				●					○	●					38A 80 N VS	45	69936639662	€00.00	2	+++	
	01	-	-	-				●						●					19A 60 M VS	63	69936675988	€00.00	6	+++	
	01	-	-	-				●					○	●					38A 60 M VS	45	66253050455	€00.00	2	+++	
	01	-	-	-				●						●	○				SGB 60 K VS3	63	66243541086	€00.00	5	++++	
	01	-	-	-				●									●			39C 120 K VS	45	69936675636	€00.00	2	+++
	01	-	-	-				●						●	○				SGB 120 J VX	45	69936677029	€00.00	2	++++	
	01	-	-	-				●						○	●				38A 60 K VS3	63	66243541076	€00.00	5	++++	
200x8x20	01	-	-	-				●					○	●					38A 60 L VS3	63	66243541090	€00.00	5	++++	



GRAIN COLOUR CODE

	NQ		NQ Vit ³		A
	38A		38A Vit ³		19A
	32A		GF		SG
	86A		25A		
	37C		39C		

DIM DxTxH (mm)	SHAPE	P	FA	FB	Tools		Grinding		Materials		SPECIFICATION	MOS (m/s)	ART. NO.	PRICE	PK QTY	QUALITY TIER		
					Recess/Inner concave Diameter	Recess/Concave Depth A	Recess/Concave Depth B	Saw Sharpening	Bench Wheels	Internal Diameter							External Diameter	Surface
200x8x32	01	-	-	-	●				●	●			SGB 60 K VS3	63	66243541088	€00.00	5	++++
	01	-	-	-	●				●	●			19A 60 M VS	63	69936675990	€00.00	6	+++
	01	-	-	-	●				●	●			38A 60 M VS	63	69936658078	€00.00	1	+++
	01C	-	-	-	●				●	●			38A 60 L 6 VS3	35	69210431430	€00.00	5	++++
200x10x20	01	-	-	-	●				●	●			38A 60 L VS3	63	66243541091	€00.00	5	++++
200x10x32	01	-	-	-	●				●	●			38A 120 J VS	45	69936675819	€00.00	1	+++
	01	-	-	-		●				●	●		39C 100 K VS	35	69936639461	€00.00	2	+++
	01	-	-	-	●				●	●			38A 60 L VS3	63	66253348277	€00.00	1	++++
	01	-	-	-	●				●	●			38A 60 L VS	45	69936675818	€00.00	2	+++
	01	-	-	-	●				●	●			SGB 80 J VX	45	69936639158	€00.00	2	++++
	01	-	-	-	●				●	●			SGB 60 J VX	45	69936639157	€00.00	2	++++
	01	-	-	-	●					●	●		39C 120 K VS	45	69936675637	€00.00	2	+++
	01	-	-	-	●				●	●			38A 60 K VS3	63	66253354044	€00.00	2	++++
200x13x31,75	01	-	-	-		●			●	●	●		3SG 60 K VS	50	69936623241	€00.00	2	+++++
	01	-	-	-			●		●	●			SGA 46 K VX	50	66253122005	€00.00	2	++++
	01	-	-	-			●		●	●	●		3SG 46 K VS	50	69936623236	€00.00	2	+++++
	01	-	-	-			●		●	●			38A 120 I VS	35	69936641286	€00.00	4	+++
	01	-	-	-	●				●	●			SGB 60 J VX	45	69936639160	€00.00	2	++++
200x13x32	01	-	-	-	●				●	●			19A 60 M VS	63	69936675994	€00.00	6	+++
	01	-	-	-	●				●	●			38A 60 L VS	45	69936675823	€00.00	1	+++
	01	-	-	-	●				●	●			38A 60 J VS	45	69936675821	€00.00	1	+++
	01	-	-	-	●					●	●		39C 80 J VS	45	69936676152	€00.00	2	+++
	01	-	-	-	●				●	●			SGB 120 J VX	45	69936676608	€00.00	2	++++
	01	-	-	-	●				●	●			38A 60 L VS3	63	66253348352	€00.00	1	++++
	01	-	-	-	●				●	●			38A 60 L VS	45	69936675827	€00.00	2	+++
200x16x76,2	01	-	-	-	●				●	●			39C 80 K VS	45	69936641417	€00.00	2	+++
200x20x20	01	-	-	-	●				●	●			39C 80 M VS	45	69936640220	€00.00	2	+++
200x20x31,75	01	-	-	-		●			●	●			SGB 70 H 12 VXP	50	69936623902	€00.00	2	++++
	01	-	-	-			●		●	●	●		3SG 46 K VX	50	69936623774	€00.00	2	+++++
	01	-	-	-	●				●	●			38A 60 K VS3	63	66253354038	€00.00	1	++++
	01	-	-	-			●		●	●			A 60 N VS	35	69936623591	€00.00	2	+++
	01	-	-	-			●		●	●			A 46 N VS	35	69936623592 [†]	€00.00	2	+++
	01	-	-	-			●		●	●			A 46 N VS	35	69936623592	€00.00	2	+++
	01	-	-	-	●				●	●			38A 46 K VS3	63	66253354039	€00.00	2	++++
200x20x32	01	-	-	-	●				●	●			39C 80 K VS	45	69936676351	€00.00	2	+++
	01	-	-	-	●				●	●			SGB 60 K VX	45	66253049887	€00.00	5	++++
	01	-	-	-			●		●	●			39C 80 K VS	45	66253338053 [†]	€00.00	2	+++
	01	-	-	-			●		●	●			39C 60 K VS	45	66253338052 [†]	€00.00	2	+++
	01	-	-	-			●		●	●			A 60 N VS	45	69936666929	€00.00	2	+++
	01	-	-	-			●		●	●			A 36 O VS	45	66253338192 [†]	€00.00	2	+++

BONDED ABRASIVES

BONDED ABRASIVES FOR PRECISION GRINDING

PRODUCT RECOMMENDATION

Highly recommended ●
Recommended ○

DIM DxDxH (mm)	SHAPE	P	FA	FB	Recess/Inner concave Diameter	Recess/Concave Depth A	Recess/Concave Depth B	Tools	Saw Sharpening	Bench Wheels	Internal Diameter	External Diameter	Surface	High alloyed steels & HSS	Soft steels	Inox	Non-Ferrous & Carbide	Cast iron	SPECIFICATION	MOS (m/s)	ART. NO.	PRICE	PK QTY	QUALITY TIER	
																									Deburring & Sharpening
200x20x32	01	-	-	-						●					●				●	A 60 N VS	45	66253338024 ⁺	€00.00	2	+++
200x20x32	01	-	-	-						●					●				●	A 46 N VS	45	66253338023 ⁺	€00.00	2	+++
200x20x32	01	-	-	-				●							●	○			○	3SG 60 H 12 VXP	45	69936677181	€00.00	2	+++++
200x20x32	01	-	-	-				●							○	●			○	38A 46 N VS	45	69936641400	€00.00	1	+++
200x20x32	01	-	-	-				●							○	●			○	38A 60 K VS	45	66253051077	€00.00	2	+++
200x20x32	01	-	-	-				●							○	●			○	38A 60 N VS	45	66253338099 ⁺	€00.00	2	+++
200x20x32	01	-	-	-				●							○	●			○	38A 46 N VS	45	66253338096 ⁺	€00.00	2	+++
200x20x32	01	-	-	-				●							●	○				SGB 46 H VX	45	69936639171	€00.00	2	+++++
200x20x32	01	-	-	-				●									●	●		39C 60 K VS	45	69936641418	€00.00	2	+++
200x20x32	01	-	-	-				●							●	○				SGB 60 H 10 VXP	45	69936639172	€00.00	2	+++++
200x20x32	01	-	-	-						●					●					A 46 N VS	45	69936641375	€00.00	2	+++
200x20x32	01	-	-	-				●							●	○	○			3NQ 46 J VQN	45	66253261995	€00.00	2	+++++
200x20x32	01	-	-	-				●							○	●				38A 80 K VS	45	66253051080	€00.00	2	+++
200x20x32	01	-	-	-						●					●					A 30 P VS	45	69936675566	€00.00	2	+++
200x20x32	01	-	-	-				●							●	○	○			2NQ 60 I 8 VS3	45	66253357059	€00.00	2	+++++
200x20x32	01	-	-	-						●					○	●			○	38A 60 L VS	35	69936641402	€00.00	2	+++
200x20x32	01	-	-	-				●							○	●				38A 46 H VS	45	69936675551	€00.00	1	+++
200x20x32	01	-	-	-				●							○	●			●	37C 60 K 6 VK	35	69210431674	€00.00	5	+++
200x20x32	01	-	-	-				●							○	●				38A 60 N VS	45	69936667154	€00.00	2	+++
200x20x32	01	-	-	-						●							●	●		39C 120 K VS	45	66253338185 ⁺	€00.00	2	+++
200x20x32	01	-	-	-						●							●	●		39C 46 K VS	45	66253338051 ⁺	€00.00	2	+++
200x20x32	01	-	-	-				●									●	●		39C 120 K VS	45	69936641421	€00.00	2	+++
200x20x32	01	-	-	-				●							○	●				38A 46 K VS	45	66253051075	€00.00	2	+++
200x20x50	01	-	-	-						●					○	●			○	38A 80 N VS	45	66253338066 ⁺	€00.00	2	+++
200x20x50	01	-	-	-				●							○	●				3SG 60 J VX	45	66253050362	€00.00	2	+++++
200x20x50	01	-	-	-				●							○	●			○	38A 46 K VS	45	69936641104	€00.00	2	+++
200x20x50	01	-	-	-						●					○	●			○	38A 60 J VS	35	69936639462	€00.00	2	+++
200x20x50,8	01	-	-	-				●							○	●				38A 60 H VS	45	69936675834	€00.00	1	+++
200x20x50,8	01	-	-	-				●							○	●				38A 60 K VS	45	66253049967	€00.00	1	+++
200x20x50,8	01	-	-	-				●							●	○				3SG 60 H 12 VXP	45	66243593696	€00.00	2	+++++
200x20x50,8	01	-	-	-				●							○	●				38A 46 J VS	45	69936675832	€00.00	2	+++
200x20x50,8	01	-	-	-				●							●	○				3SG 46 I 12 VXP	45	66253052711	€00.00	2	+++++
200x20x50,8	01	-	-	-									●		○	●				3SG 46 K VS	50	69936623654	€00.00	2	+++++
200x20x51	01	-	-	-				●									●	●		39C 60 K VS	45	69936640176	€00.00	2	+++
200x20x51	01	-	-	-				●							●	○				SGB 60 J VX	45	69936639251	€00.00	2	+++++
200x20x76,2	01	-	-	-				●							○	●				3SG 46 H VX	45	66253050156	€00.00	2	+++++
200x20x76,2	01	-	-	-				●							○	●				38A 60 L VS	45	69936675836	€00.00	1	+++
200x25x20	01	-	-	-						●					○	●			○	38A 60 M VS	35	69936641405	€00.00	4	+++
200x25x20	01	-	-	-						●							●	●		39C 80 K VS	35	69936641422	€00.00	2	+++
200x25x20	01	-	-	-				●							○	●				38A 60 K 5 VBE	35	69210432867	€00.00	0	+++

BONDED ABRASIVES



GRAIN COLOUR CODE

	NQ		NQ Vit ³		A
	38A		38A Vit ³		19A
	32A		GF		SG
	86A		25A		
	37C		39C		

DIM DxTxH (mm)	SHAPE	P	FA	FB	Tools		Grinding	Materials					SPECIFICATION	MOS (m/s)	ART. NO.	PRICE	PK QTY	QUALITY TIER	
					Recess/Inner concave Diameter	Recess/Concave Depth A		Recess/Concave Depth B	Deburring & Sharpening	Internal Diameter	External Diameter	Surface							High alloyed steels & HSS
200x25x31,75	01	-	-	-										A 36 P VS	35	69936623910	€00.00	2	+++
	01	-	-	-										A 60 N VS	35	69936623913	€00.00	2	+++
	01	-	-	-										A 46 N VS	35	69936623911	€00.00	2	+++
	01	-	-	-										38A 60 L VS	35	69936623794	€00.00	2	+++
	01	-	-	-										39C 60 K VS	35	69936623912	€00.00	2	+++
	01	-	-	-										39C 100 K VS	35	69936623599	€00.00	2	+++
	05	110	10	-										3SG 60 G VSPF	35	69936640304	€00.00	2	+++++
	05	105	13	-										3SG 60 K VS	50	69936621575	€00.00	2	+++++
200x25x32	01	-	-	-										39C 80 K VS	45	66253338056 ⁺	€00.00	2	+++
	01	-	-	-										38A 80 K VS	45	66253051082	€00.00	1	+++
	01	-	-	-										A 46 M VS	45	66253050271	€00.00	2	+++
	01	-	-	-										A 46 N VS	45	66253338026 ⁺	€00.00	2	+++
	01	-	-	-										38A 46 N VS	45	69936641406	€00.00	1	+++
	01	-	-	-										38A 60 M VS	35	69936639846	€00.00	1	+++
	01	-	-	-										39C 60 K VS	45	66253338055 ⁺	€00.00	2	+++
	01	-	-	-										38A 60 L VS	45	69936641407	€00.00	1	+++
	01	-	-	-										A 24 R VS	45	69936676374	€00.00	2	+++
	01	-	-	-										39C 46 L VS	45	69936675639	€00.00	2	+++
	01	-	-	-										A 60 N VS	45	66253195830 ⁺	€00.00	2	+++
	01	-	-	-										38A 46 N VS	45	66253338142 ⁺	€00.00	2	+++
	01	-	-	-										38A 80 N VS	45	69936675847	€00.00	1	+++
	01	-	-	-										38A 60 M VS	45	66253051079	€00.00	1	+++



BONDED ABRASIVES FOR PRECISION GRINDING

PRODUCT RECOMMENDATION

Highly recommended ●
Recommended ○

DIM DxDxH (mm)	SHAPE	P	FA	FB	Tools			Grinding			Materials				SPECIFICATION	MOS (m/s)	ART. NO.	PRICE	PK QTY	QUALITY TIER	
					Recess/Inner concave Diameter	Recess/Concave Depth A	Recess/Concave Depth B	Saw Sharpening	Bench Wheels	Internal Diameter	External Diameter	Surface	High alloyed steels & HSS	Soft steels							Inox
200x25x32	01	-	-	-	●						●	○			3SG 60 J VX	45	66253054889	£00.00	2	+++++	
	01	-	-	-							●				A 36 O VS	45	66253338025 [†]	£00.00	2	+++	
	01	-	-	-							●		●		39C 46 K VS	45	66253338054 [†]	£00.00	2	+++	
	01	-	-	-							●				A 60 N VS	45	69936693708 [†]	£00.00	2	+++	
	01	-	-	-							○	●		○	38A 60 N VS	45	66253338065 [†]	£00.00	2	+++	
	01	-	-	-	●								●	●	39C 120 K VS	45	69936641428	£00.00	2	+++	
	01	-	-	-	●								●	○	SGB 60 K VX	45	66253049888	£00.00	2	+++++	
	01	-	-	-									●		A 36 P VS	45	69936641383	£00.00	2	+++	
	01	-	-	-	●								●	●	39C 100 J VS	45	66253050375	£00.00	2	+++	
	01	-	-	-	●								●	●	39C 80 K VS	45	66253050276	£00.00	2	+++	
	01	-	-	-									●		A 30 P VS	45	69936641382	£00.00	2	+++	
	01	-	-	-	●						○	●			38A 100 J VS	45	66243570496	£00.00	1	+++	
	01	-	-	-	●								●	●	39C 60 K VS	45	69936641424	£00.00	2	+++	
	01	-	-	-									●		A 36 Q VS	45	66253050267	£00.00	2	+++	
	01	-	-	-	●								●	●	39C 80 L VS	35	69936641427	£00.00	2	+++	
01	-	-	-	●						○	●			38A 46 L VS	45	69936627127	£00.00	1	+++		
200x25x50	05	110	10	-						●	●	○		3SG 60 I VS	35	69936639454	£00.00	2	+++++		
200x25x50,8	01	-	-	-	●							○		SGB 46 K VX	45	66253050183	£00.00	2	+++++		
200x25x51	01	-	-	-	●							○	●	38A 46 K VS	45	66253051086	£00.00	2	+++		
	01	-	-	-	●							○	●	38A 60 L VS	45	69936640125	£00.00	2	+++		
200x25x76,2	01	-	-	-								●		A 46 N VS	45	69936675568	£00.00	2	+++		
	01	-	-	-	●						○	●		38A 60 L VS	35	69936675845	£00.00	1	+++		
	01	-	-	-	●								●	●	39C 120 K VS	45	69936675674	£00.00	2	+++	
	01	-	-	-	●						○	●			38A 46 L VS	35	69936675842	£00.00	2	+++	
	01	-	-	-	●								●	●	39C 80 L VS	45	69936675673	£00.00	2	+++	
	01	-	-	-	●						○	●			38A 46 N VS	45	69936675841	£00.00	1	+++	
	01	-	-	-	●								●	●	39C 80 K VS	35	69936675641	£00.00	2	+++	
	01	-	-	-	●								●	●	39C 60 K VS	45	69936675672	£00.00	2	+++	
	01	-	-	-	●						○	●			38A 60 N VS	45	69936675846	£00.00	1	+++	
200x32x32	01	-	-	-	●							○	●	38A 46 M VS	45	66253052712	£00.00	1	+++		
	01	-	-	-	●							●	○	SGB 60 K VX	45	66253049892	£00.00	2	+++++		
	01	-	-	-	●								●	●	39C 120 K VS	45	69936675677	£00.00	2	+++	
	01	-	-	-								●			A 36 P VS	45	6993666932	£00.00	2	+++	
	01	-	-	-	●								●	●	39C 60 K VS	45	69936640293	£00.00	2	+++	
	01	-	-	-									●		A 60 N VS	45	69936690246	£00.00	2	+++	
	01	-	-	-	●						○	●			38A 60 L VS	45	69936675855	£00.00	2	+++	
	01	-	-	-	●									●	●	39C 80 K VS	45	69936667106	£00.00	2	+++
	01	-	-	-									●		A 46 N VS	45	69936640814	£00.00	2	+++	
200x32x51	01	-	-	-	●							○	●	38A 60 L VS	45	69936640245	£00.00	2	+++		



SHAPE 01 SHAPE 05 SHAPE 07 SHAPE 20 SHAPE 01C

Recess/Inner concave Diameter
 Recess/Concave Depth A
 Recess/Concave Depth B
 Tools
 Saw Sharpening
 Bench Wheels
 Internal Diameter
 External Diameter
 Surface
 High alloyed steels & HSS
 Soft steels
 Inox
 Non-Ferrous & Carbide
 Cast iron

GRAIN COLOUR CODE

	NQ		NQ Vit³		A
	38A		38A Vit³		19A
	32A		GF		SG
	86A		25A		
	37C		39C		

DIM DxTxH (mm)	SHAPE	P	FA	FB	Deburring & Sharpening	Grinding	Materials	SPECIFICATION	MOS (m/s)	ART. NO.	PRICE	PK QTY	QUALITY TIER
200x32x76,2	01	-	-	-	●			38A 60 N VS	45	69936675854	€00.00	1	+++
	01	-	-	-	●			38A 46 N VS	45	69936675849	€00.00	2	+++
	01	-	-	-	●			39C 80 K VS	45	69936675644	€00.00	2	+++
	01	-	-	-		●		A 46 N 6 VS	45	66243593707	€00.00	2	+++
	01	-	-	-	●			39C 60 K VS	45	69936675643	€00.00	2	+++
200x40x20	05	110	25	-		●		39C 80 J VS	35	69936640285	€00.00	2	+++
200x40x50,8	01	-	-	-	●			38A 46 I VS	45	69936681707	€00.00	2	+++
225x5x60	01	-	-	-	●			38A 54 J VS	45	69936675859	€00.00	1	+++
225x20x51	01	-	-	-	●			3SG 60 H 12 VXP	45	69936676452	€00.00	2	+++++
	01	-	-	-	●			38A 46 I VS	45	69936640871	€00.00	2	+++
	01	-	-	-	●			SGB 60 H VX	45	69936640943	€00.00	2	++++
225x25x76,2	01	-	-	-	●			3SG 46 H VX	45	66243570377	€00.00	2	+++++
225x32x76,2	01	-	-	-	●			3SG 60 H 12 VXP	45	66243593705	€00.00	2	+++++
	01	-	-	-	●			3SG 46 H VX	45	66253055043	€00.00	2	+++++
230x10x32	01	-	-	-	●			38A 60 M VS	63	69936675929	€00.00	6	+++
230x25x32	01	-	-	-		●		39C 80 K VS	35	69936639374	€00.00	2	+++
230x25x50,8	01	-	-	-	●			38A 60 H VS	45	69936639829	€00.00	1	+++
230x5x31,75	01	-	-	-	●			19A 54 J VS	40	69936623905	€00.00	2	+++
250x3x32	01	-	-	-		●		SGB 80 K VS3	50	66243541097	€00.00	5	++++
250x10x20	01	-	-	-		●		38A 60 L VS3	63	66243541093	€00.00	5	++++
250x10x32	01	-	-	-	●			38A 60 M VS	63	69936675931	€00.00	6	+++
	01C	-	-	-		●		38A 60 L 6 VS3	35	69210431945	€00.00	5	++++
250x13x32	01	-	-	-	●			38A 60 L VS3	63	66253348353	€00.00	1	++++
250x20x76,2	01	-	-	-	●			38A 60 L VS	45	69936675862	€00.00	1	+++
250x25x31,75	01	-	-	-		●		A 36 O VS	35	69936623907	€00.00	1	+++
	01	-	-	-		●		39C 60 K VS	35	69936623664	€00.00	1	+++
	01	-	-	-		●		A 60 N VS	35	69936623918	€00.00	1	+++
	01	-	-	-		●		A 46 N VS	35	69936623914	€00.00	1	+++
250x25x32	01	-	-	-	●			38A 60 L 5 VS	45	66253049927	€00.00	1	+++
	01	-	-	-	●			39C 80 L VS	45	69936675679	€00.00	1	+++
	01	-	-	-		●		A 46 N VS	45	69936641386	€00.00	1	+++
	01	-	-	-		●		A 36 P VS	45	69936666940	€00.00	1	+++
250x25x76	01	-	-	-			● ● ● ● ●	2NQ 60 G VS3	35	66253348365	€00.00	1	+++++
	01	-	-	-			● ● ● ● ●	32A 60 I VS	35	69936639898	€00.00	2	+++
250x25x76,2	01	-	-	-			● ● ● ● ●	2NQ 46 G VS3	35	66253348371	€00.00	1	+++++
	01	-	-	-	●			38A 60 L VS	45	69936623733	€00.00	1	+++
	01	-	-	-		●		SGA 46 K VX	50	61463693965	€00.00	1	++++
	01	-	-	-	●			38A 60 I VS	45	66253050101	€00.00	1	+++
	01	-	-	-	●			SGB 70 H 12 VXP	45	69936623901	€00.00	1	++++
	01	-	-	-	●			38A 60 K VS3	63	66253354040	€00.00	2	++++
	01	-	-	-	●			38A 46 L VS	45	69936623691	€00.00	1	+++

BONDED ABRASIVES

BONDED ABRASIVES FOR PRECISION GRINDING

PRODUCT RECOMMENDATION

Highly recommended ●
Recommended ○

DIM DxTxH (mm)	SHAPE	P	FA	FB	Recess/Inner concave Diameter			Tools	Saw Sharpening	Bench Wheels	Internal Diameter	External Diameter	Surface	High alloyed steels & HSS	Soft steels	Inox	Non-Ferrous & Carbide	Cast iron	SPECIFICATION	MOS (m/s)	ART. NO.	PRICE	PK QTY	QUALITY TIER
					Recess/Concave Depth A	Recess/Concave Depth B	Recess/Concave Depth C																	
250x25x76,2	01	-	-	-	●									○	●				38A 80 L VS	45	69936623651	€00.00	1	+++
	01	-	-	-	●									●	○				3SG 46 K VS	45	69936623668	€00.00	1	+++++
	01	-	-	-	●									●	○				3SG 60 K VX	45	66253055045	€00.00	1	+++++
	01	-	-	-	●									●	○				SGB 60 K VX	45	66253050126	€00.00	1	+++++
	01	-	-	-	●									●	○				3SG 54 F 11 VXP	45	69936676054	€00.00	1	+++++
	01	-	-	-	●									○	●				38A 46 K VS3	63	66253354041	€00.00	2	+++++
	01	-	-	-	●									●	○				SGB 46 K VX	45	66253050124	€00.00	1	+++++
250x32x32	01	-	-	-	●											●	●		39C 80 K VS	45	69936640845	€00.00	1	+++
	01	-	-	-				●								●	●		39C 80 K VS	45	66253338060 [†]	€00.00	1	+++
	01	-	-	-				●								●	●		39C 60 K VS	45	66253338059 [†]	€00.00	1	+++
	01	-	-	-				●								●			39C 46 K VS	45	66253338057 [†]	€00.00	1	+++
	01	-	-	-				●								●			A 36 O VS	45	66253289887 [†]	€00.00	1	+++
	01	-	-	-				●								●			A 46 N VS	45	66253289885 [†]	€00.00	1	+++
	01	-	-	-				●								●			A 24 Q VS	45	69936666942	€00.00	1	+++
	01	-	-	-				●								●			A 60 N VS	45	66253338027 [†]	€00.00	1	+++
	01	-	-	-				●						○	●			○	38A 46 N VS	45	66253338067 [†]	€00.00	1	+++
	01	-	-	-				●						○	●			○	38A 60 N VS	45	66253338068 [†]	€00.00	1	+++
250x32x32	01	-	-	-	●									○	●				38A 60 N VS	45	69936667158	€00.00	1	+++
	01	-	-	-	●											●	●		39C 60 K VS	45	69936639837	€00.00	1	+++
	01	-	-	-	●									●	○				SGB 60 K VX	45	66253050162	€00.00	1	+++++
	01	-	-	-				●								●			A 36 P VS	45	69936666943	€00.00	1	+++
	01	-	-	-				●								●			A 60 M VS	45	69936642130	€00.00	1	+++
250x32x76,2	01	-	-	-	●								●	○				3SG 46 H VX	45	66253055046	€00.00	1	+++++	
250x40x32	01	-	-	-				●							●				A 36 Q VS	45	69936666945	€00.00	1	+++
	01	-	-	-				●							●				A 60 N VS	45	69936666946	€00.00	1	+++
250x40x51	01	-	-	-									○	●			●	37C 60 K 6 VK	35	69210431004	€00.00	3	+++	
250x40x76	01	-	-	-									○	●	○	●			38A 60 L 6 VS3	35	69210431657	€00.00	3	+++++
	01	-	-	-									○	●	○	●			38A 46 L 6 VS3	35	69210432025	€00.00	3	+++++
250x40x76,2	01	-	-	-	●									●	○				3SG 46 I VX	45	66253050259	€00.00	1	+++++
	01	-	-	-	●									●	○				3SG 46 G 12 VXPC	45	69936676056	€00.00	1	+++++
300x25x127	01	-	-	-										●	○	●			SGA 46 K VS	50	61463699584	€00.00	1	+++++
	01	-	-	-										●	○	○			3NQ 60 K VQN	45	66253262040	€00.00	1	+++++
	01	-	-	-										●	○	○			3SG 46 K VX	45	66253055050	€00.00	1	+++++
	01	-	-	-										●	○	●			38A 46 J VS	35	69936623662	€00.00	1	+++
	01	-	-	-										●	○	○			SGB 80 I 10 VXP	45	66253050121	€00.00	1	+++++
	01	-	-	-										●	○	○			38A 60 K VS3	63	66253354042	€00.00	2	+++++
	01	-	-	-										●	○	○			SGA 60 K VX	50	61463693967	€00.00	1	+++++
	01	-	-	-										●	○	○			SGB 80 K VX	35	69936678987	€00.00	0	+++++
	01	-	-	-										●			●	●	39C 120 K VS	35	69936675646	€00.00	1	+++
	01	-	-	-										●	○	○			3SG 60 H 12 VXP	45	69936677184	€00.00	1	+++++
	01	-	-	-										●	○				19A 60 M VS	35	69936623719	€00.00	1	+++

BONDED ABRASIVES



Recess/Inner concave Diameter

Recess/Concave Depth A

Recess/Concave Depth B

Tools

Saw Sharpening

Bench Wheels

Internal Diameter

External Diameter

Surface

High alloyed steels & HSS

Soft steels

Inox

Non-Ferrous & Carbide

Cast iron

GRAIN COLOUR CODE

	NQ		NQ Vit ³		A
	38A		38A Vit ³		19A
	32A		GF		SG
	86A		25A		
	37C		39C		

DIM DxTxH (mm)	SHAPE	P	FA	FB	Deburring & Sharpening	Grinding	Materials	SPECIFICATION	MOS (m/s)	ART. NO.	PRICE	PK QTY	QUALITY TIER
300x25x127	01	-	-	-				38A 80 L VS	45	69936623648	€00.00	1	+++
	01	-	-	-				39C 60 K VS	45	69936623687	€00.00	1	+++
	01	-	-	-				39C 80 J VS	45	69936640343	€00.00	1	+++
	01	-	-	-				38A 60 K VS	45	66253050105	€00.00	1	+++
	01	-	-	-				SGB 60 K VX	45	66253050132	€00.00	1	++++
	01	-	-	-				SGA 80 L VX	50	61463693973	€00.00	1	++++
	01	-	-	-				2NQ 60 J VS3	45	66253348372	€00.00	1	+++++
300x32x127	01	-	-	-				A 36 O VS	45	69936675580	€00.00	1	+++
	01	-	-	-				SGB 60 K VX	45	69936676386	€00.00	1	++++
	01	-	-	-				A 46 N VS	45	69936675581	€00.00	1	+++
	01	-	-	-				A 24 Q VS	45	69936675579	€00.00	1	+++
	01	-	-	-				38A 46 N VS	45	66253338070 ⁺	€00.00	1	+++
300x32x127	01	-	-	-				SGB 46 F 12 VXP	45	69936676705	€00.00	0	++++
	01	-	-	-				38A 60 L VS	45	69936675884	€00.00	1	+++
	01	-	-	-				38A 46 H VS	45	69936675883	€00.00	1	+++
	01	-	-	-				3SG 60 K VX	45	66253055872	€00.00	1	+++++
300x32x32	01	-	-	-				A 46 N VS	45	66253338029 ⁺	€00.00	1	+++
	01	-	-	-				A 60 N VS	45	66253338188 ⁺	€00.00	1	+++
	01	-	-	-				38A 60 K VS	45	66253051100	€00.00	1	+++
	01	-	-	-				39C 60 K VS	45	66253338074 ⁺	€00.00	1	+++
	01	-	-	-				A 36 O VS	45	66253289888 ⁺	€00.00	1	+++
	01	-	-	-				A 36 O VS	45	69936675575	€00.00	1	+++
	01	-	-	-				39C 80 K VS	45	66253338075 ⁺	€00.00	1	+++
	01	-	-	-				38A 60 N VS	45	66253338069 ⁺	€00.00	1	+++
	01	-	-	-				38A 46 N VS	35	66253381592 ⁺	€00.00	1	+++
	01	-	-	-				38A 60 N VS	45	69936639618	€00.00	1	+++
300x32x50,8	01	-	-	-				A 46 N VS	45	69936675578	€00.00	1	+++
300x32x76,2	01	-	-	-				38A 46 H VS	45	69936675880	€00.00	1	+++
300x40x30	01	-	-	-				A 36 P VS	45	69936681734	€00.00	1	+++
300x40x31,75	01	-	-	-				A 36 O VS	35	69936623686	€00.00	1	+++
	01	-	-	-				A 60 N VS	35	69936623724	€00.00	1	+++
	01	-	-	-				39C 60 L VS	35	69936623682	€00.00	1	+++
	01	-	-	-				A 46 N VS	35	69936623703	€00.00	1	+++
300x40x32	01	-	-	-				39C 80 K VS	45	69936676387	€00.00	1	+++
	01	-	-	-				A 36 P VS	35	69936640222	€00.00	1	+++
	01	-	-	-				A 46 N VS	45	69936639682	€00.00	1	+++
	01	-	-	-				A 60 M VS	45	69936640221	€00.00	1	+++
	01	-	-	-				39C 60 K VS	45	69936639362	€00.00	1	+++
300x40x76	01	-	-	-				38A 60 K 5 VS	45	66253049953	€00.00	1	+++
300x40x76,2	01	-	-	-				A 36 O VS	45	69936675607	€00.00	1	+++

BONDED ABRASIVES

BONDED ABRASIVES FOR PRECISION GRINDING

PRODUCT RECOMMENDATION

Highly recommended ●
Recommended ○

DIM DxTxH (mm)	SHAPE	P	FA	FB	Tools		Internal Diameter	External Diameter	Surface	High alloyed steels & HSS	Soft steels	Inox	Non-Ferrous & Carbide	Cast iron	SPECIFICATION	MOS (m/s)	ART. NO.	PRICE	PK QTY	QUALITY TIER
					Recess/Inner concave Diameter	Recess/Concave Depth A														
300x40x127	01	-	-	-					●	○	●				38A 60 L VS	45	69936675891	€00.00	1	+++
	01	-	-	-					●		●				A 46 N VS	45	69936675585	€00.00	1	+++
	01	-	-	-					●		●				A 60 N VS	45	66253338032 [†]	€00.00	1	+++
	01	-	-	-					●	●	○				39C 80 K VS	45	69936675649	€00.00	1	+++
	01	-	-	-					●	●	○				3SG 60 K VX	45	66253055053	€00.00	1	+++++
	01	-	-	-					●	○	●				38A 46 J VS	35	69936675889	€00.00	1	+++
	01	-	-	-					●		●				A 36 O VS	45	66253338031 [†]	€00.00	1	+++
	01	-	-	-					●			●	●		39C 60 K VS	45	66253338077 [†]	€00.00	1	+++
	01	-	-	-					●			●	●		39C 60 K VS	45	69936675684	€00.00	1	+++
	01	-	-	-					●		●				A 36 O VS	45	69936675584	€00.00	1	+++
	01	-	-	-					●	●	○				SGB 46 G 10 VXP	45	69936639946	€00.00	1	+++++
	05	190	12	-					●	○	●				SGA 60 K VS	50	61463699585	€00.00	1	+++++
	05	190	12	-					●	●	○				19A 60 M VS	35	69936621518	€00.00	1	+++
300x40x127	01	-	-	-				●	●	○				3SG 60 K VS	50	69936621533	€00.00	1	+++++	
	01	-	-	-				●	●	○				SGB 60 K VX	45	66253050179	€00.00	1	+++++	
	01	-	-	-				●		●		●		A 24 Q VS	45	69936675583	€00.00	1	+++	
	01	-	-	-				●		●		●		39C 80 K VS	45	66253338078 [†]	€00.00	1	+++	
	01	-	-	-					●	●	○			A 46 N VS	45	66253289892 [†]	€00.00	1	+++	
	05	190	12	-					●	○	●			3SG 46 H VX	45	66253055893	€00.00	1	+++++	
300x50x32	01	-	-	-				●		●				38A 60 L VS	35	69936621532	€00.00	1	+++	
	01	-	-	-				●		●				A 36 O VS	45	69936681823	€00.00	1	+++	
300x50x76,2	01	-	-	-				○	●	○	●			38A 46 I VS	45	66253050251	€00.00	0	+++	
	07	160	10	10				●	●	○				3SG 46 H VS	35	69936672033	€00.00	1	+++++	
300x50x127	01	-	-	-				●	○	●				38A 46 J VS	45	69936623649	€00.00	1	+++	
	01	-	-	-				●	●	○				SGB 46 G 10 VXP	45	66243570384	€00.00	1	+++++	
	01	-	-	-				●		●				A 36 O VS	45	66253338102 [†]	€00.00	1	+++	
	01	-	-	-				●		●				A 60 N VS	45	66253338038 [†]	€00.00	1	+++	
	01	-	-	-				●		●				A 46 N VS	45	66253338037 [†]	€00.00	1	+++	
	01	-	-	-				●	●	○				SGB 46 H 11 VXP	45	66253054500	€00.00	1	+++++	
	01	-	-	-				●				●	●		39C 46 K VS	45	66253338079 [†]	€00.00	1	+++
	01	-	-	-				●				●	●		39C 60 K VS	45	66253338080 [†]	€00.00	1	+++
	01	-	-	-				○	●					●	37C 60 K 6 VK	35	69210431686	€00.00	2	+++
	01	-	-	-				○	●	○	●				38A 80 L 6 VS3	35	69210431072	€00.00	2	+++++
350x50x127	01	-	-	-				●		○	●			38A 60 N VS	45	66253338073 [†]	€00.00	1	+++	
	01	-	-	-				●		○	●			38A 46 N VS	45	66253338072 [†]	€00.00	1	+++	
355x25x127	01	-	-	-				○	●	○	●			SGB 60 L VX	45	66253050135	€00.00	1	+++++	
	01	-	-	-				○	●	○	●			SGA 46 J VS	50	61463699586	€00.00	1	+++++	
	01	-	-	-				○	●	○	●			3SG 60 K VS	50	69936623716	€00.00	1	+++++	
	01	-	-	-				○	●	○	●			38A 60 L VS	45	69936675901	€00.00	1	+++	
	01	-	-	-				○	●	○	●			3SG 60 L VX	45	66253055895	€00.00	1	+++++	

BONDED ABRASIVES



GRAIN COLOUR CODE

NQ	NQ Vit ³	A
38A	38A Vit ³	19A
32A	GF	SG
86A	25A	
37C	39C	

Recess/Inner concave Diameter
 Recess/Concave Depth A
 Recess/Concave Depth B
 Tools
 Saw Sharpening
 Bench Wheels
 Internal Diameter
 External Diameter
 Surface
 High alloyed steels & HSS
 Soft steels
 Inox
 Non-Ferrous & Carbide
 Cast iron

DIM DxTxH (mm)	SHAPE	P	FA	FB	Deburring & Sharpening	Grinding	Materials	SPECIFICATION	MOS (m/s)	ART. NO.	PRICE	PK QTY	QUALITY TIER
355x32x127	01	-	-	-				2NQ 60 J VS3	45	66253348373	€00.00	1	+++++
	01	-	-	-				38A 60 L VS	45	69936675903	€00.00	1	+++
	01	-	-	-				SGB 54 E 12 VXP	45	69936676713	€00.00	0	+++++
355x40x127	01	-	-	-				2NQ 46 G VS3	45	66253348367	€00.00	1	+++++
	01	-	-	-				38A 46 J VS	45	69936623753	€00.00	1	+++
	01	-	-	-		●		A 24 Q VS	45	69936675586	€00.00	1	+++
	01	-	-	-				SGB 46 J VX	45	66253050117	€00.00	1	+++++
	01	-	-	-				38A 60 L VS	45	69936675908	€00.00	1	+++
	01	-	-	-				3SG 60 L VX	45	66253055057	€00.00	1	+++++
	01	-	-	-			●	39C 60 K VS	45	69936675685	€00.00	1	+++
	01	-	-	-				SGA 80 I 10 VXP	50	61463699589	€00.00	1	+++++
	01	-	-	-				3SG 60 K VS	50	69936623611	€00.00	1	+++++
	01	-	-	-		●		A 46 N VS	45	69936675587	€00.00	1	+++
	01	-	-	-				SGB 46 G 10 VXP	45	66253049901	€00.00	1	+++++
	05	215	13	-				38A 60 L VS	35	69936675909	€00.00	1	+++
	05	215	13	-				3SG 60 K VS	35	69936640371	€00.00	0	+++++
355x50x31,75	01	-	-	-		●		A 60 N VS	35	69936623742	€00.00	1	+++
355x50x127	01	-	-	-				38A 46 K VS	45	66253051108	€00.00	1	+++
	01	-	-	-				SGB 46 J VX	45	69936623781	€00.00	2	+++++
	01	-	-	-		●		A 36 O VS	45	69936675589	€00.00	1	+++
	01	-	-	-				38A 60 L VS	35	69936675914	€00.00	1	+++
	01	-	-	-				3SG 46 J VX	45	66253055063	€00.00	1	+++++
	01	-	-	-				3NQ 46 H VQN	45	66253262049	€00.00	1	+++++
	01	-	-	-				SGA 54 G 12 VXP	50	61463693982	€00.00	1	+++++
	01	-	-	-				SGB 54 G 10 VXP	45	66253049857	€00.00	1	+++++
	01	-	-	-				3SG 46 F 12 VXP	45	69936623900	€00.00	1	+++++
	01	-	-	-				38A 46 I VS	45	69936675913	€00.00	1	+++
	01	-	-	-				38A 60 K 5 VS	45	66253049951	€00.00	1	+++
	01	-	-	-				SGB 60 K VX	45	66253050138	€00.00	1	+++++
	01	-	-	-				2NQ 46 G VS3	45	66253348366	€00.00	1	+++++
	07	190	12	13				38A 60 L VS	35	69936675899	€00.00	1	+++
	400x25x127	01	-	-	-				SGB 60 K VX	45	69936644046	€00.00	1
400x50x127	01	-	-	-				37C 60 K 6 VK	45	69210431098	€00.00	1	+++
	01	-	-	-				38A 60 L 6 VS3	45	69210431108	€00.00	1	+++++
400x50x203	01	-	-	-				38A 60 L 6 VS3	45	69210431757	€00.00	1	+++++
406x25x127	01	-	-	-				38A 60 L VS	45	69936694018	€00.00	1	+++
	01	-	-	-				SGA 80 I 10 VXP	50	61463694555	€00.00	1	+++++
	01	-	-	-				3SG 60 L VX	45	66253055083	€00.00	1	+++++
406x32x127	01	-	-	-				38A 60 L VS	45	66253049841	€00.00	1	+++

BONDED ABRASIVES FOR PRECISION GRINDING

PRODUCT RECOMMENDATION

Highly recommended ●
Recommended ○

DIM DxTxH (mm)	SHAPE	P	FA	FB	Tools			Grinding		Materials					SPECIFICATION	MOS (m/s)	ART. NO.	PRICE	PK QTY	QUALITY TIER
					Recess/Inner concave Diameter	Recess/Concave Depth A	Recess/Concave Depth B	Saw Sharpening	Bench Wheels	Internal Diameter	External Diameter	Surface	High alloyed steels & HSS	Soft steels						
406x40x127	01	-	-	-				●	●	●	○				3SG 60 L VX	45	66253055086	€00.00	1	+++++
	01	-	-	-				●	●	○	●				38A 60 J VS3	45	66253348356	€00.00	1	++++
	01	-	-	-				●	●	●	○	●	●		39C 80 K VS	45	66243466414	€00.00	1	+++
	01	-	-	-				●	●	●	○				SGB 60 K VX	45	66253049843	€00.00	1	++++
	05	215	13					●	●	○	●				38A 60 M VS	35	66243448163	€00.00	1	+++
	05	215	13	-				●	●	●	○				32A 60 K VS	35	66243448202	€00.00	1	+++
	05	215	13	-				●	●	●	○	●	●		39C 60 J VS	50	66243468572	€00.00	0	+++
	20	215	8	-				●	●	○	●				GF 60 K VX	50	66243469015	€00.00	1	++++
	20	215	13	-				●	●	○	●				38A 60 N VS	35	66243448167	€00.00	1	+++
406x50x50	01	-	-	-			●			●				A 24 Q VS	45	66243448177	€00.00	1	+++	
406x50x127	01	-	-	-				●	●	●	○				3SG 46 H VX	45	66253055912	€00.00	1	+++++
	01	-	-	-				●	●	●	○				SGB 60 K VX	45	66253055072	€00.00	1	++++
	01	-	-	-					●	○	●				38A 46 I 11 VXP	45	66253054508	€00.00	1	+++
	05	215	13	-				●	●	○					3SG 54 E 12 VXP	35	66243448671	€00.00	0	+++++
	05	215	13	-				●	●	○	●				GF 46 I VX	35	66243469004	€00.00	1	++++
	05	215	13	-					●	○	●				GF 46 F 12 VXP	35	66243469021	€00.00	1	++++
	05	215	13	-				●	●	●	○				32A 46 I VS	35	66243448172	€00.00	0	+++
	20	215	8	-				●	●	○	●				GF 60 K VX	50	66243468991	€00.00	1	++++
406x50x127	01	-	-	-				●	●	○	●				38A 46 H VS	35	69936694574	€00.00	1	+++
	01	-	-	-				●	○	●					SGA 80 I 10 VXP	50	61463694556	€00.00	1	++++
	01	-	-	-				●	●	○					5SG 46 G 12 VXP	45	66243468188	€00.00	1	+++++
	01	-	-	-			●			●					A 36 0 VS	45	66243467497	€00.00	1	+++
	01	-	-	-				●	●	○					SGB 46 G 10 VXP	45	66243468401	€00.00	1	++++
	01	-	-	-			●			●					A 24 Q VS	45	66243467496	€00.00	1	+++
	01	-	-	-				●	●	○	●				SGA 46 K VS	50	61463699644	€00.00	1	++++
	01	-	-	-				●	●	○					3SG 54 F 12 VXP	45	66253054506	€00.00	1	+++++
	01	-	-	-				●	●	●	○				SGB 46 H VX	45	66243448363	€00.00	1	++++
	05	215	13	-					●	●					32A 46 F 12 VXP	35	66243448726	€00.00	0	+++
	05	215	13	-				●	●	○	●				38A 46 I VS	35	66243448178	€00.00	1	+++
	05	215	13	-					●	●					32A 60 F 12 VBEP	32	66243448133	€00.00	0	+++
	05	215	13	-				●	●	○					3SG 54 D 12 VXP	35	66243467861	€00.00	0	+++++
	05	215	13	-				●	●	○					3SG 46 F 12 VXP	35	66243448690	€00.00	0	+++++
	05	215	13	-					●	○	●				GF 54 E 12 VXP	35	66243469022	€00.00	1	++++
	05	215	13	-				●	●	●	○				32A 46 J VS	35	66243448205	€00.00	1	+++
	05	215	13	-					●	●	○				SGB 46 F 12 VXP	35	66243448824	€00.00	0	++++
	05	215	13	-				●	●	●	○				3SG 46 I VS	35	66243448179	€00.00	1	+++++
	05	215	13	-					●	○	●				38A 46 F 12 VXP	35	66243448705	€00.00	0	+++

BONDED ABRASIVES

Recess/Inner concave Diameter
 Recess/Concave Depth A
 Recess/Concave Depth B
 Tools
 Saw Sharpening
 Bench Wheels
 Internal Diameter
 External Diameter
 Surface
 High alloyed steels & HSS
 Soft steels
 Inox
 Non-Ferrous & Carbide
 Cast iron

GRAIN COLOUR CODE

	NQ		NQ Vit ³		A
	38A		38A Vit ³		19A
	32A		GF		SG
	86A		25A		
	37C		39C		

DIM DxTxH (mm)	SHAPE	P	FA	FB	Deburring & Sharpening	Grinding	Materials	SPECIFICATION	MOS (m/s)	ART. NO.	PRICE	PK QTY	QUALITY TIER		
406x50x127	05	215	13	-		<input checked="" type="checkbox"/>	<input checked="" type="checkbox"/>	<input checked="" type="checkbox"/>	<input checked="" type="checkbox"/>	GF 60 L VX	50	66243468990	€00.00	0	++++
	20	215	8	-		<input checked="" type="checkbox"/>	<input checked="" type="checkbox"/>	<input checked="" type="checkbox"/>	<input checked="" type="checkbox"/>	GF 60 L VX	50	66243468989	€00.00	1	++++
	20	215	13	-		<input checked="" type="checkbox"/>	<input checked="" type="checkbox"/>	<input checked="" type="checkbox"/>	<input checked="" type="checkbox"/>	38A 60 K VS	35	66243448201	€00.00	1	+++
	20	215	13	-		<input checked="" type="checkbox"/>	<input checked="" type="checkbox"/>	<input checked="" type="checkbox"/>	<input checked="" type="checkbox"/>	38A 60 M VS	35	66243448116	€00.00	1	+++
	20	215	13	-		<input checked="" type="checkbox"/>	<input checked="" type="checkbox"/>	<input checked="" type="checkbox"/>	<input checked="" type="checkbox"/>	3SG 60 K VS	35	66243448204	€00.00	1	+++++
406x63x127	07	215	12	12			<input checked="" type="checkbox"/>	<input checked="" type="checkbox"/>	<input checked="" type="checkbox"/>	GF 46 F 12 VXP	35	66243449251	€00.00	1	++++
	20	215	13	-		<input checked="" type="checkbox"/>	<input checked="" type="checkbox"/>	<input checked="" type="checkbox"/>	<input checked="" type="checkbox"/>	GF 60 L VX	50	66243468993	€00.00	1	++++
406x76x127	07	215	12	25			<input checked="" type="checkbox"/>	<input checked="" type="checkbox"/>	<input checked="" type="checkbox"/>	38A 46 F 12 VBEP	35	66243448206	€00.00	0	+++
	07	215	13	25			<input checked="" type="checkbox"/>	<input checked="" type="checkbox"/>	<input checked="" type="checkbox"/>	GF 46 F 12 VXP	35	66243469016	€00.00	1	++++
	07	215	12	25		<input checked="" type="checkbox"/>	<input checked="" type="checkbox"/>	<input checked="" type="checkbox"/>	<input checked="" type="checkbox"/>	32A 46 I VS	35	66243448354	€00.00	1	+++
	07	215	12	25			<input checked="" type="checkbox"/>	<input checked="" type="checkbox"/>	<input checked="" type="checkbox"/>	SGB 46 F 12 VXP	35	66243448691	€00.00	0	++++
	07	215	12	25			<input checked="" type="checkbox"/>	<input checked="" type="checkbox"/>	<input checked="" type="checkbox"/>	3SG 54 E 12 VXP	35	66243448665	€00.00	0	+++++
	07	215	13	25		<input checked="" type="checkbox"/>	<input checked="" type="checkbox"/>	<input checked="" type="checkbox"/>	<input checked="" type="checkbox"/>	GF 46 I VX	35	66243469001	€00.00	1	++++
406x100x152,4	07	220	15	15			<input checked="" type="checkbox"/>	<input checked="" type="checkbox"/>	<input checked="" type="checkbox"/>	3SG 54 E 12 VXP	35	66243449287	€00.00	0	+++++
	07	220	15	15			<input checked="" type="checkbox"/>	<input checked="" type="checkbox"/>	<input checked="" type="checkbox"/>	GF 46 I VX	35	66243449285	€00.00	1	++++
457x50x127	01	-	-	-		<input checked="" type="checkbox"/>	<input checked="" type="checkbox"/>	<input checked="" type="checkbox"/>	<input checked="" type="checkbox"/>	38A 60 L VS	45	66243466558	€00.00	1	+++
	20	215	8	-		<input checked="" type="checkbox"/>	<input checked="" type="checkbox"/>	<input checked="" type="checkbox"/>	<input checked="" type="checkbox"/>	GF 60 L VX	50	66243468995	€00.00	0	++++
	20	215	13	-		<input checked="" type="checkbox"/>	<input checked="" type="checkbox"/>	<input checked="" type="checkbox"/>	<input checked="" type="checkbox"/>	38A 60 M VS	50	66243448676	€00.00	1	+++
457x50x203,2	01	-	-	-		<input checked="" type="checkbox"/>	<input checked="" type="checkbox"/>	<input checked="" type="checkbox"/>	<input checked="" type="checkbox"/>	38A 46 J VS	35	66243466557	€00.00	1	+++
	01	-	-	-		<input checked="" type="checkbox"/>	<input checked="" type="checkbox"/>	<input checked="" type="checkbox"/>	<input checked="" type="checkbox"/>	SGA 60 K VX	50	61463694560	€00.00	1	++++
457x63x127	20	215	13	-		<input checked="" type="checkbox"/>	<input checked="" type="checkbox"/>	<input checked="" type="checkbox"/>	<input checked="" type="checkbox"/>	GF 60 L VX	50	66243468996	€00.00	1	++++
457x80x203,2	07	290	13	13			<input checked="" type="checkbox"/>	<input checked="" type="checkbox"/>	<input checked="" type="checkbox"/>	SGB 46 F 12 VXP	35	66243468578	€00.00	0	++++
	07	280	13	13			<input checked="" type="checkbox"/>	<input checked="" type="checkbox"/>	<input checked="" type="checkbox"/>	GF 46 F 12 VXP	35	66243469018	€00.00	0	++++
508x50x203,2	01	-	-	-		<input checked="" type="checkbox"/>	<input checked="" type="checkbox"/>	<input checked="" type="checkbox"/>	<input checked="" type="checkbox"/>	3SG 60 K VX	45	66253055088	€00.00	1	+++++
	01	-	-	-		<input checked="" type="checkbox"/>	<input checked="" type="checkbox"/>	<input checked="" type="checkbox"/>	<input checked="" type="checkbox"/>	38A 60 L VS	35	66243466565	€00.00	1	+++
	01	-	-	-		<input checked="" type="checkbox"/>	<input checked="" type="checkbox"/>	<input checked="" type="checkbox"/>	<input checked="" type="checkbox"/>	SGA 80 I 10 VXP	50	61463699663	€00.00	1	++++
500x60x203	20	290	10	-		<input checked="" type="checkbox"/>	<input checked="" type="checkbox"/>	<input checked="" type="checkbox"/>	SGB 60 K VX	50	66243468575	€00.00	1	++++	

BONDED ABRASIVES

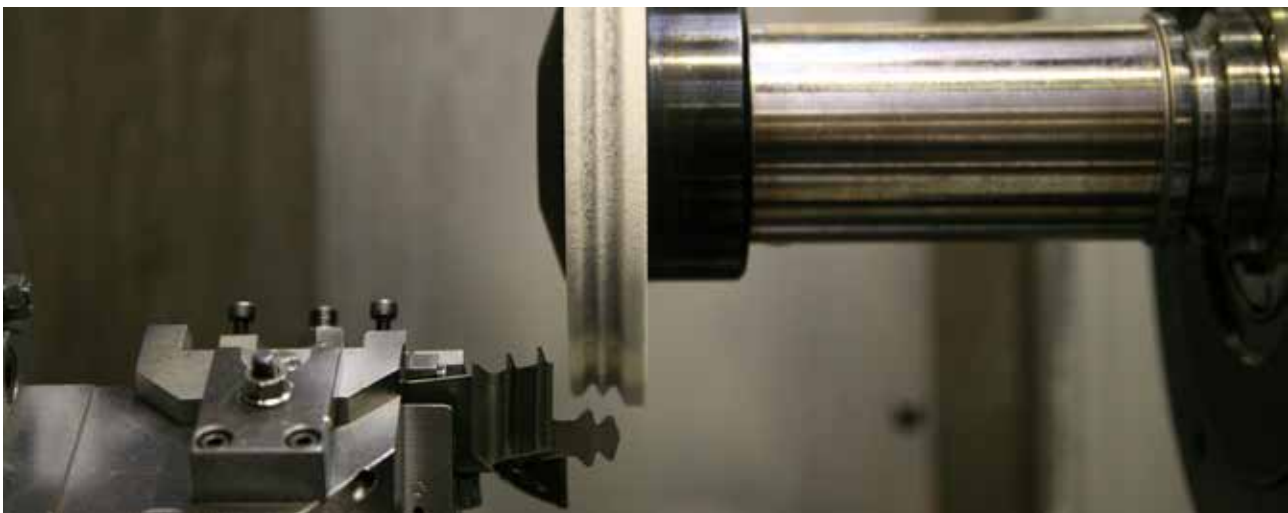



STRAIGHT & TAPERED CUPS FOR PRECISION GRINDING

SHAPE KEY

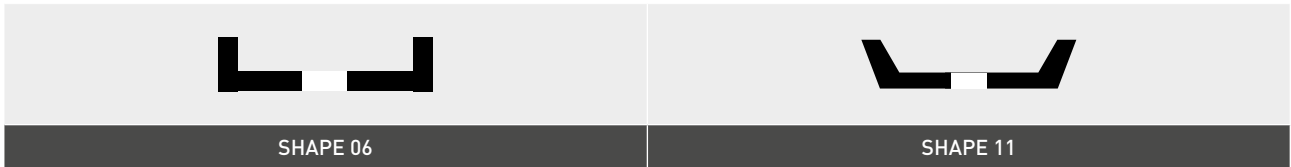

PRODUCT RECOMMENDATION

Highly recommended ●
Recommended ○

DIM DxTxH (mm)	SHAPE	W	E	Deburring & Sharpening	Grinding	Materials						SPECIFICATION	MOS (m/s)	ART. NO.	PRICE	PK QTY	QUALITY TIER
						High alloyed steels & HSS	Soft steels	Inox	Non-Ferrous & Carbide	Cast iron							
63x40x20	06	10	10	●	○	●	○	○	○	○	○	38A 60 J VS3	45	66253348322	€00.00	10	+++++
80x32x20	11	6	8	●	○	●	○	○	○	○	○	SGB 60 L VX	45	66253050137	€00.00	6	+++++
80x40x20	06	10	10	●	○	●	○	○	○	○	○	SGB 60 L VX	45	66253050098	€00.00	10	+++++
	06	6	10	●	○	●	○	○	○	○	○	SGB 60 J VX	45	66243570391	€00.00	10	+++++
	06	6	8	●	○	●	○	○	○	○	○	38A 60 L VS3	63	66253348323	€00.00	6	+++++
	06	8	8	●	○	●	○	○	○	○	○	38A 60 J VS3	63	66253348289	€00.00	6	+++++
80x40x32	06	10	10	●	○	●	○	○	○	○	○	38A 46 J VS3	45	66253348326	€00.00	10	+++++
100x40x20	11	8	10	●	○	●	○	○	○	○	○	38A 60 K VS	45	69936686170	€00.00	2	+++
	11	8	10	●	○	●	○	○	○	○	○	38A 60 L VS	45	69936688495	€00.00	2	+++
	11	8	10	●	○	●	○	○	○	○	○	3SG 60 K VX	45	66253050110	€00.00	2	+++++
100x40x31,75	11	6	13	●	○	●	○	○	○	○	○	38A 46 J 6 VS3	35	66253358217	€00.00	2	+++++
	11	6	13	●	○	●	○	○	○	○	○	3SG 60 K VS	32	69936624043	€00.00	2	+++++
	11	6	13	●	○	●	○	○	○	○	○	38A 60 J 6 VS3	35	66253358216	€00.00	2	+++++
	11	6	13	●	○	●	○	○	○	○	○	38A 60 J VS3	32	66253348630	€00.00	2	+++++
	11	6	13	●	○	●	○	○	○	○	○	38A 54 K VS	32	69936624609	€00.00	2	+++
	11	6	13	●	○	●	○	○	○	○	○	3SG 54 K VS	32	69936624036	€00.00	2	+++++
100x40x32	06	8	10	●	○	●	○	○	○	○	○	38A 60 K VS	45	69936674854	€00.00	2	+++
	11	8	10	●	○	●	○	○	○	○	○	3SG 60 K VX	45	66253050114	€00.00	2	+++++
	11	8	10	●	○	●	○	○	○	○	○	38A 60 K VS	45	69936686169	€00.00	2	+++
	11	13	13	●	○	●	○	○	○	○	○	2NQ 46 J VS3	45	66253348633	€00.00	2	+++++

GRAIN COLOUR CODE

	NQ		NQ Vit ³		A
	38A		38A Vit ³		19A
	32A		GF		SG
	86A		25A		
	37C		39C		

DIM DxTxH (mm)	SHAPE	W	E	Tools		Grinding	Surface	High alloyed steels & HSS	Soft steels	Inox	Non-Ferrous & Carbide	Cast iron	SPECIFICATION	MOS (m/s)	ART. NO.	PRICE	PK QTY	QUALITY TIER
				Deburring & Sharpening	Saw Sharpening													
100x50x20	06	10	13	●			○	●	○				3SG 80 L VX	45	66253049966	€00.00	2	+++++
	06	10	13	●			○	○	●				38A 80 J VS3	45	66253348324	€00.00	2	++++
	06	10	13	●			○	○	●				38A 60 M VS	45	69936639460	€00.00	2	+++
	06	10	13	●			○	●	○				3SG 60 L VX	45	66253049960	€00.00	2	+++++
	06	10	13	●			○			●	●		39C 80 J VS	45	69936640131	€00.00	2	+++
	06	10	10	●			○	○	●				38A 46 K VS	45	69936644193	€00.00	2	+++
	06	10	10	●			○	○	●				38A 60 J VS3	45	66253348327	€00.00	2	++++
	06	8	10	●			○	●	○				SGB 60 K VX	45	69936641284	€00.00	2	++++
	06	10	10	●			○	○	●				38A 80 J VS	45	69936639600	€00.00	2	+++
	06	10	10	●			○	○	●				38A 120 I 8 VS3	45	66253358793	€00.00	2	++++
	06	10	10	●			○	○	●				38A 60 I VS3	45	66253348629	€00.00	2	++++
	06	10	10	●			○	●	○				3SG 60 J VX	45	66253050069	€00.00	2	+++++
	06	10	10	●			○	●	○				3SG 60 K VX	45	66253049965	€00.00	2	+++++
	06	10	13	●			○	○	●				38A 60 L VS	45	69936639450	€00.00	2	+++
	100x50x32	06	10	10	●			○	●	○				3SG 60 K VX	45	66253050073	€00.00	2
06		10	10	●			○	○	●				38A 60 K VS	45	69936674859	€00.00	2	+++
125x40x31,75	06	13	13	●			○	○	●				38A 60 J 8 VS3	45	66253358795	€00.00	2	++++
	06	13	13	●			○	○	●				38A 46 J 8 VS3	45	66253358794	€00.00	2	++++
	06	8	10	●			○	○	●				38A 60 K VS	32	69936623645	€00.00	2	+++
	11	8	10	●			○	○	●				38A 60 J 6 VS3	35	66253358219	€00.00	2	++++
	11	10	10	●			○	○	●				38A 54 K VS	35	69936625578	€00.00	2	+++
125x40x32	11	8	10	●			○	○	●				38A 46 K VS	45	69936686175	€00.00	2	+++
	11	8	10	●			○	○	●				38A 60 K VS	45	69936686176	€00.00	2	+++
	11	8	10	●			○	○	●				SGB 46 J VX	45	69936682429	€00.00	2	++++
125x45x20	11	6	13	●			○	○	●				3SG 46 K VX	45	66253055954	€00.00	2	+++++
	11	6	13	●			○	○	●				SGB 60 K VX	45	69936686736	€00.00	2	++++
125x50x32	06	13	13	●			○	○	●				38A 46 K VS	45	69936674867	€00.00	2	+++
	06	10	13	●			○	○	●				38A 60 L VS	45	69936639992	€00.00	2	+++
	06	13	13	●			○	●	○				SGB 60 J VX	45	66253050075	€00.00	2	++++
125x63x32	06	10	13	●			○	○	●				SGB 60 K VX	45	69936640579	€00.00	2	++++
	06	25	16	●			○			●	●		39C 60 J V	45	69936668305	€00.00	2	+++
150x40x32	06	16	13	●			○	○	●				38A 46 H VS	45	69936674872	€00.00	2	+++
	06	16	13	●			○	○	●				38A 60 K VS	45	69936674875	€00.00	2	+++
150x50x32	06	16	16	●			○	○	●				SGB 60 K VX	45	66253050076	€00.00	2	++++
	11	10	13	●			○	○	●				SGB 60 K VX	45	66253050134	€00.00	2	++++
	06	16	16	●			○	○	●				3SG 46 K VX	45	66253050068	€00.00	2	+++++
	11	10	13	●			○	○	●				SGB 46 J VX	45	66253050133	€00.00	2	++++
	11	10	13	●			○	○	●				38A 46 K VS	45	69936686177	€00.00	2	+++
	06	16	16	●			○	○	●				38A 60 K VS	45	69936674879	€00.00	2	+++
	11	10	13	●			○	○	●				38A 60 K VS	45	69936682576	€00.00	2	+++
	06	16	16	●			○	○	●				38A 60 K VS	45	69936639480	€00.00	2	+++
150x50x65	06	20	16	●			○			●	●		39C 80 J VS	32	69936639798	€00.00	2	+++
	06	20	16	●			○	○	●				38A 60 L VS	45	69936639480	€00.00	2	+++

BONDED ABRASIVES FOR PRECISION GRINDING

PRODUCT RECOMMENDATION

Highly recommended ●
Recommended ○

DIM DxDxH (mm)	SHAPE	W	E	Rim Width		Tools	Saw Sharpening	Bench Wheels	Internal Diameter	External Diameter	Surface	High alloyed steels & HSS	Soft steels	Inox	Non-Ferrous & Carbide	Cast iron	SPECIFICATION	MOS (m/s)	ART. NO.	PRICE	PK QTY	QUALITY TIER
				Back Thickness	Deburring & Sharpening																	
150x60x32	06	10	16	●							○	●	○				SGB 54 K VX	45	66253050099	€00.00	2	+++++
150x63x32	06	16	16	●							○	○	●				38A 36 I VS	45	69936640369	€00.00	2	+++
	06	16	16	●							○	○	●				38A 46 J VS	45	69936674881	€00.00	2	+++
150x63x50,8	06	13	13	●							○	●	○				SGB 46 J VX	45	66253054727	€00.00	2	+++++
	06	16	16	●							○	●	○				SGB 60 J VX	45	66253050082	€00.00	2	+++++
150x80x32	06	16	16	●							○	●	○				SGB 36 H VX	45	66253050080	€00.00	2	+++++
	06	20	20	●							○	○	●				38A 46 H VS	45	69936674905	€00.00	2	+++
150x80x32	06	20	20	●							○	○	●				38A 46 I VS	45	69936658606	€00.00	2	+++
	06	20	20	●							○	●	○				SGB 46 H VX	45	66253050096	€00.00	2	+++++
150x80x32	06	20	20	●							○	●	○				SGB 46 G 10 VXP	45	69936676357	€00.00	2	+++++
	06	20	20	●							○	○	●				38A 46 F 12 VXP	45	66253051529	€00.00	2	+++
175x75x76,2	06	20	20	●							○	●	○				SGB 46 G 11 VXP	45	66253050097	€00.00	2	+++++
180x40x76,2	06	20	20	●							○	○	●				38A 36 I VS	45	69936681747	€00.00	2	+++
	06	32	13	●							○	○	●				38A 46 M VS	45	69936674884	€00.00	2	+++
180x63x50,8	06	16	16	●							○	○	●				38A 36 H VS	45	69936674887	€00.00	2	+++
	06	16	16	●							○	●	○				SGB 46 J VX	45	66253050084	€00.00	2	+++++
180x76x32	06	16	16	●							○	○	●				38A 36 I VS	45	69936639449	€00.00	2	+++
180x76x78	06	16	16	●							○	○	●				38A 36 I 8 VS3	45	66253348321	€00.00	2	+++++
	06	16	16	●							○	○	●				38A 46 H VS	45	69936639616	€00.00	2	+++
180x76x78	06	16	16	●							○	●	○				3SG 36 I VX	45	66253049962	€00.00	2	+++++
	06	16	16	●							○	○	●				38A 36 J VS	45	69936639817	€00.00	2	+++
180x80x32	06	16	16	●							○	○	●				38A 46 H VS	45	69936674889	€00.00	2	+++
200x40x32	06	45	15	●							○	○	●				38A 60 L VS	45	66243570537	€00.00	2	+++
	06	45	15	●							○	○	●				38A 46 L VS	45	66243570536	€00.00	2	+++
200x40x76,2	06	40	13	●							○	●	○				SGB 60 L VX	45	66253050087	€00.00	2	+++++
	06	40	13	●							○			●	●		39C 80 J V	45	69936668348	€00.00	2	+++
200x40x76,2	06	40	13	●							○			●	●		39C 60 J V	45	69936668347	€00.00	2	+++
	06	40	13	●							○	○	●				38A 46 K VS	45	69936674880	€00.00	2	+++
200x40x76,2	06	40	13	●							○			●	●		39C 120 J V	45	69936668353	€00.00	2	+++
	06	40	13	●							○	○	●				38A 46 M VS	45	69936674890	€00.00	2	+++
200x63x50,8	06	20	20	●							○	○	●				38A 46 H VS	45	69936674898	€00.00	2	+++
200x82x78	06	16	20	●							○	●	○				3SG 36 I VX	45	66253049964	€00.00	2	+++++
	06	16	20	●							○	○	●				38A 46 H VS3	45	66253348325	€00.00	2	+++++
200x82x78	06	16	20	●							○	○	●				38A 36 H VS3	45	66253348319	€00.00	2	+++++
	06	16	20	●							○	●	○				SGB 36 H 10 VXP	45	69936679013	€00.00	2	+++++
300x63x127	06	40	20	●							○			●	●		39C 60 J V	45	69936668365	€00.00	1	+++

BONDED ABRASIVES



DISHES FOR PRECISION GRINDING

SHAPE KEY

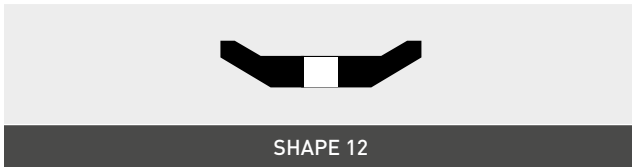

GRAIN COLOUR CODE

NQ	NQ Vit ³	A
38A	38A Vit ³	19A
32A	GF	SG
86A	25A	
37C	39C	

DIM DxDxH (mm)	Rim Width					Tools	Saw Sharpening	Bench Wheels	Internal Diameter	External Diameter	Surface	High alloyed steels & HSS	Soft steels	Inox	Non-Ferrous & Carbide	Cast iron	SPECIFICATION	MOS (m/s)	ART. NO.	PRICE	PK QTY	QUALITY TIER
	W	E	J	K	U																	
100x13x12,7	5	7	45	50	2,5	●						●	●				38A 60 K VS	45	69936624605	€00.00	2	+++
100x13x20	5	7	41	41	3,2	●						●	●				38A 60 J VS3	45	66253348382	€00.00	2	++++
	5	7	41	41	3,2	●						●	●				3SG 60 K VX	45	66253050236	€00.00	2	+++++
125x13x20	6	7	61	61	3,2	●						●	●	●			2NQ 60 J VS3	45	66253348378	€00.00	2	+++++
	6	7	61	61	3,2	●						●	●				3SG 60 J VX	45	69936686768	€00.00	2	+++++
150x13x20	6	7	61	61	3,2	●						●	●				38A 60 J VS3	45	66253348488	€00.00	2	++++
	8	9	56	56	3,2	●						●	●				SGB 46 K VS3	45	66253348384	€00.00	2	++++
	8	9	56	56	3,2	●						●	●				3SG 60 L VX	45	66253050231	€00.00	2	+++++
150x13x31,75	8	9	56	56	3,2	●						●	●				SGB 60 K VS3	45	66253348379	€00.00	2	++++
	7	9	86	86	3,2	●						●	●				38A 60 K VS	45	69936686199	€00.00	2	+++
150x13x32	7,5	8	76	76	3,2	●						●	●				3SG 60 K VS	35	69936624608	€00.00	2	+++++
	7	9	86	86	3,2	●						●	●				3SG 60 K VX	45	66253050239	€00.00	2	+++++
	7	9	86	86	3,2	●						●	●				38A 60 J VS3	45	66253348380	€00.00	2	++++
150x20x32	7	9	86	86	3,2	●						●	●				38A 46 K VS	45	69936686194	€00.00	2	+++
	8	9	87	87	3,2	●						●	●				SGB 60 K VX	45	66253050245	€00.00	2	++++
180x20x32	9	11	70	70	3,2	●						●	●				SGB 54 K VX	45	66253050260	€00.00	2	++++
200x20x32	10	12	90	90	3,2	●						●	●				38A 60 K VS	45	69936686215	€00.00	2	+++
200x32x32	10	12	92	92	3,2	●						●	●				SGB 46 I VX	45	66253050253	€00.00	2	++++

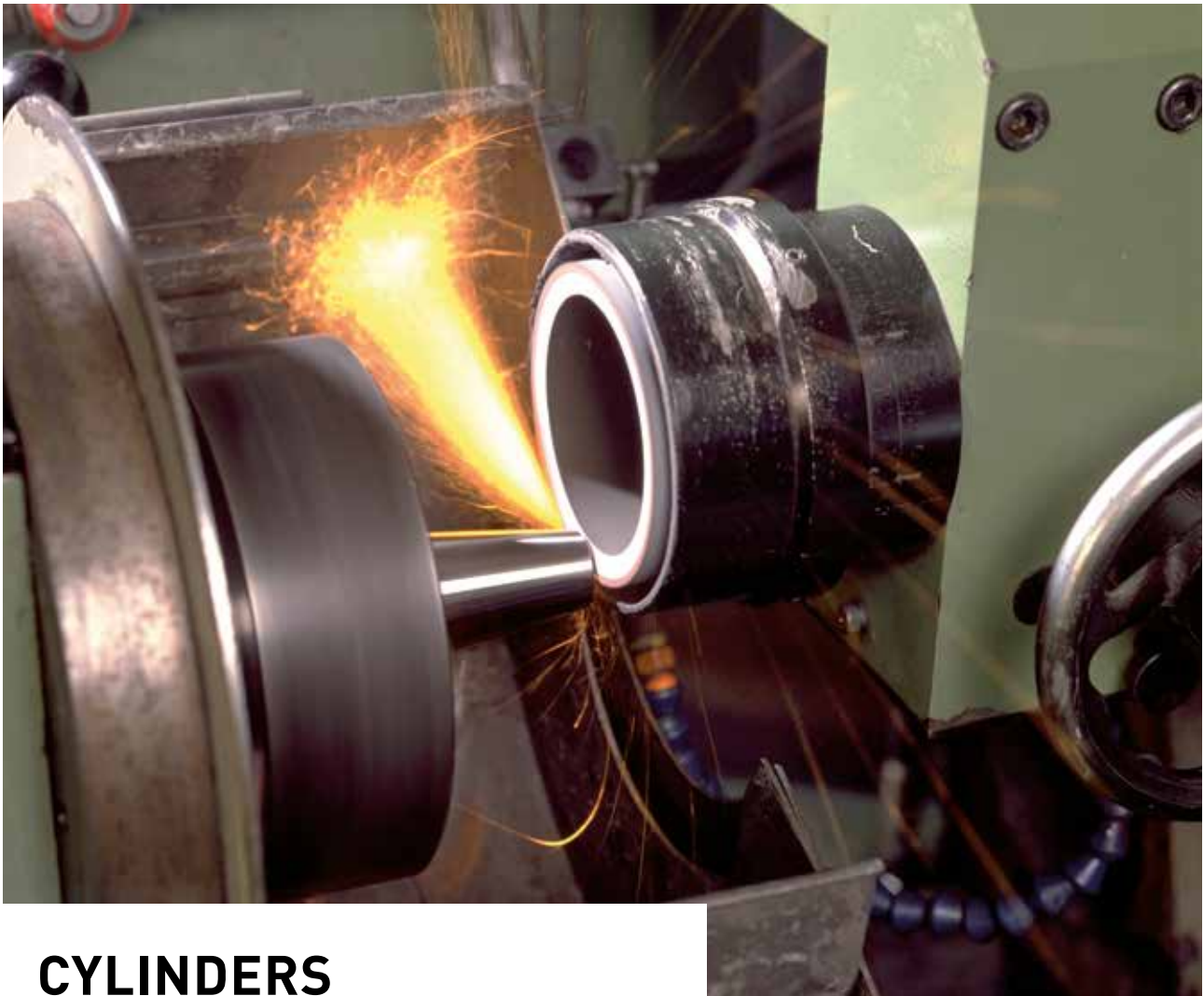

CYLINDERS FOR PRECISION GRINDING

SHAPE KEY

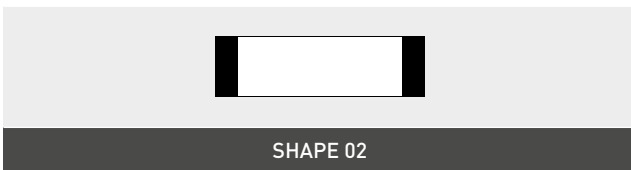

PRODUCT RECOMMENDATION

Highly recommended ●
Recommended ○

DIM DxDxH (mm)	Tools			Grinding		Materials					SPECIFICATION	MOS (m/s)	ART. NO.	PRICE	PK QTY	QUALITY TIER	
	Deburring & Sharpening	Saw Sharpening	Bench Wheels	Internal Diameter	External Diameter	Surface	High alloyed steels & HSS	Soft steels	Inox	Non-Ferrous & Carbide							Cast iron
200x100x160						●	○	●				38A 46 G VS3	45	66253348386	€00.00	1	++++
						●	●	○				SGB 46 H VX	45	69936686693	€00.00	1	++++
254x100x204						●	○	●				38A 46 G VS3	45	66253348387	€00.00	1	++++



SEGMENTS FOR PRECISION GRINDING

SHAPE KEY

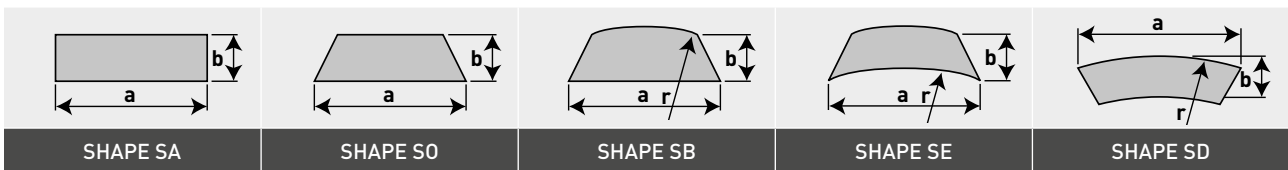

GRAIN COLOUR CODE

NQ	NQ Vit ³
38A	38A Vit ³
32A	19A
37C	SG

Tools
Saw Sharpening
Bench Wheels
Internal Diameter
External Diameter
Surface
High alloyed steels & HSS
Soft steels
Inox
Non-Ferrous & Carbide
Cast iron

PRODUCT RECOMMENDATION

Highly recommended ●
Recommended ○

DIM AxBxR	TYPE	Deburring & Sharpening	Grinding	Materials				SPECIFICATION	ART. NO.	PRICE	PK QTY	QUALITY TIER
16x50x90	SE			●	○	●		38A 36 H VS3	66253348785	€00.00	4	+++++
	SE			●	○	●		38A 46 G VS3	66253348493	€00.00	4	+++++
	SE			●	●	○	○	2NQ 36 H VS3	66253348492	€00.00	4	+++++
	SE			●	●	○	○	3NQ 46 H VQN	69083141440	€00.00	4	+++++
16x53,5x110	SE			●	○	●		38A 46 H VS	69936688614	€00.00	4	+++
	SE			●	○	●		38A 36 I VS	69936688485	€00.00	4	+++
20x42x90	SO			●	○	●		38A 60 G VS	69936686264	€00.00	4	+++
21x59,5x121	SO			●	○	●		38A 30 H VS	69936624796	€00.00	4	+++
	SO			●	○	●		38A 36 H VS3	66253348638	€00.00	4	+++++
22x60x110	SO			●	●	○	○	2NQ 36 G VS3	66253348778	€00.00	4	+++++
	SO			●	○	●		38A 36 G VS3	66253348665	€00.00	4	+++++
25x50x110	SO			●		●		19A 54 I VS	69936686249	€00.00	4	+++
	SO			●	○	●		38A 46 G VS3	66253348779	€00.00	4	+++++
	SO			●	○	●		38A 60 G VS3	66253348786	€00.00	4	+++++
	SO			●	●	○		3SG 60 G VX	66253050282	€00.00	4	+++++
25x65x100	SB			●			●	37C 30 H 8 V	69936688426	€00.00	4	+++
25x70x110	SO			●	○	●		38A 36 I VS	69936682640	€00.00	4	+++
	SO			●	○	●		38A 30 I VS	69936682296	€00.00	4	+++
	SO			●	○	●		38A 36 H VS3	66253348783	€00.00	4	+++++
	SO			●	●	○		3SG 36 E 12 VXP	69936688295	€00.00	4	+++++
25x80x150	SA			●	●	○		3SG 36 E 12 VXP	69936688321	€00.00	0	+++++
	SA			●	○	●		38A 30 I VS	69936686253	€00.00	4	+++
38x103x180	SO			●	○	●		38A 30 H VS3	66253348780	€00.00	4	+++++
	SO			●	●	○	○	3NQ 36 H VQN	69083141453	€00.00	4	+++++
	SO			●	●	○		3SG 36 H VX	66253050287	€00.00	4	+++++



NORTON

SAINT-GOBAIN®

BONDED
ABRASIVES

MOUNTED POINTS & WHEELS

MOUNTED POINTS & WHEELS

Vitrified mounted points
Organic mounted points

249-260

251
259

BONDED ABRASIVES MOUNTED POINTS & WHEELS

SHAPE A KEY

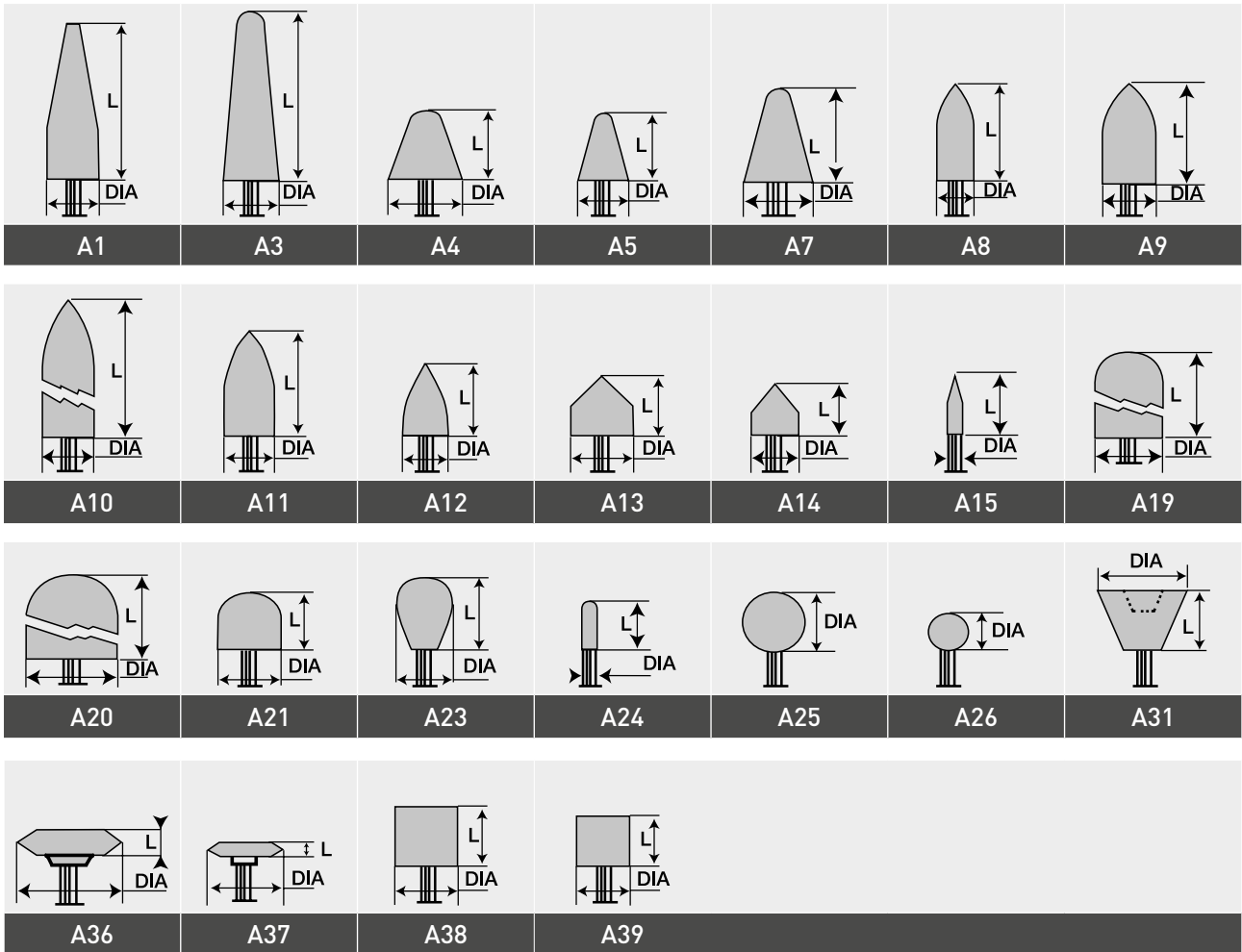

SHAPE B KEY

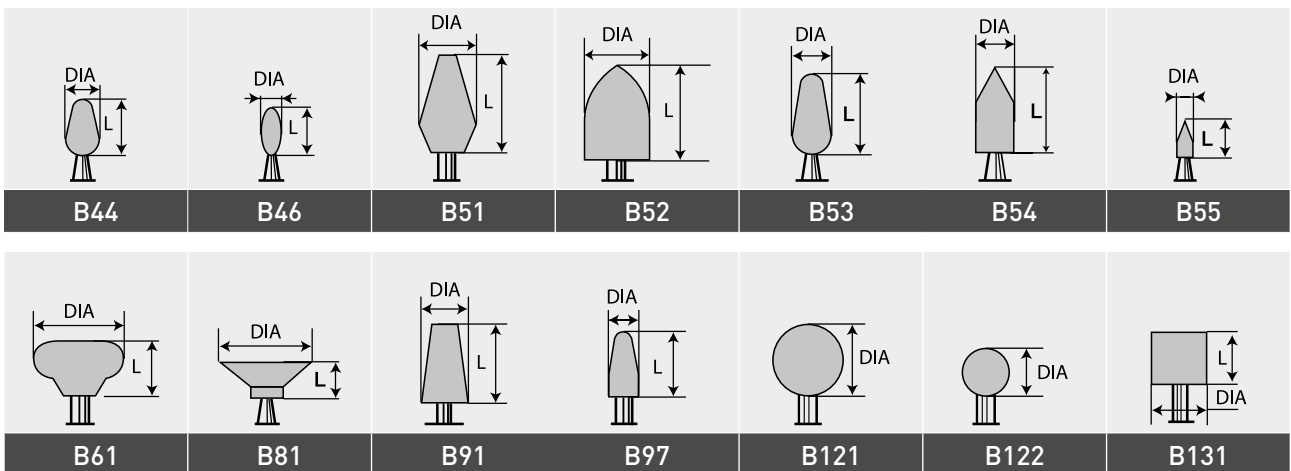

SHAPE C KEY SHAPE W KEY

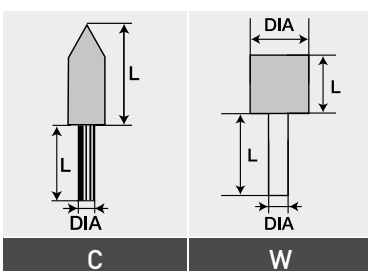

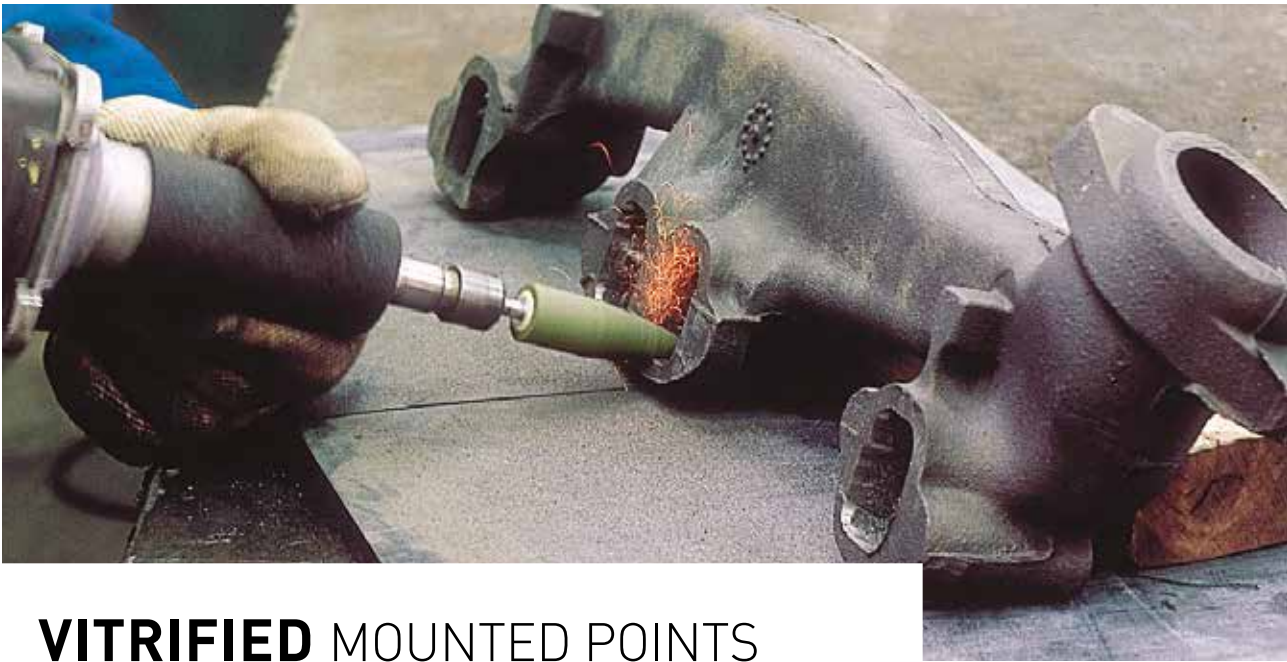

VITRIFIED MOUNTED POINTS

The Norton vitrified mounted points range provides quality and efficiency in grinding operations. The high quality grain ensures a perfect surface finish with metallographic integrity. For small jobs or high volume foundry and casting operations, or for tool room or aerospace industry applications, Norton vitrified mounted points cut cooler, and provide up to 30% higher metal removal rates.



NEW NQ VITRIFIED ++++

Unique, engineered ceramic grain shape and chemistry with proven bond technology for the coolest cut

- Sharp grain for the ultimate free cutting action and self sharpening action to eliminate glazing
- Versatile, optimized for all low, medium and high force applications
- Exceptional productivity and life
- Fastest operations on heat sensitive alloys (Fe and Ni based) and hardened metals
- Best solution for aerospace components like blades and vanes



86A/40A VITRIFIED +++

Highly refined pink aluminium oxide abrasive

- Friable grain for good cutting performance
- Long lasting profile tool
- Versatile for large variety of steels
- Reduced dress frequency



38A VITRIFIED +++

Pure white aluminium oxide abrasive

- Most friable alumina grain for easy and cool cut
- Good value for general purpose, small applications
- Compatible with most of the steel alloys
- Cool cutting, less burn
- Excellent price vs performance ratio



39C VITRIFIED +++

Highest purity green silicon carbide abrasive

- Suitable for use on castings for heavy-duty edge grinding
- Very hard and durable with excellent edge-holding capability
- Low wear rate for long product life

BONDED ABRASIVES MOUNTED POINTS & WHEELS

GRAIN COLOUR CODE

NQ
 NQ Vit³
 86A/40A
 38A
 39C

SHAPE	DIM DxL (mm)	SPINDLE DxL (mm)	SPECIFICATION	ART. NO.	MOS (RPM)	PK QTY	PRICE	QUALITY TIER
A11	22x45	6x40	■ 3NQ 80 O VS	61463620969	18000	10	£00.00	+++++
A1	20x65	6x40	■ 3NQ 80 O VS	61463688951	15000	10	£00.00	+++++
A5	20x28	6x40	■ 3NQ 80 O VS	61463688954	30000	10	£00.00	+++++
A21	25x25	6x40	■ 3NQ 80 O VS	61463688956	25000	10	£00.00	+++++
A26	Ø16	3x40	■ 3NQ 80 O VS	61463688957	54000	10	£00.00	+++++
A36	40x10	6x40	■ 3NQ 80 O VS	61463688960	25000	10	£00.00	+++++
A39	20x20	6x40	■ 3NQ 80 O VS	61463689938	25000	10	£00.00	+++++
A26	Ø16	6x40	■ 38A 90 R 9 VM	63642561043	54000	10	£00.00	+++
A38	25x25	6x40	■ 86A 60 O VS	66253054946	25000	10	£00.00	+++++
A19	30x50	6x40	■ 86A 60 O VS	66253054961	13000	10	£00.00	+++++
A3	22x70	6x40	■ 86A 36 O VS	66253055021	14000	10	£00.00	+++++
A7	30x50	6x40	■ 86A 36 O VS	66253055022	13000	10	£00.00	+++++
A5	20x28	6x40	■ 86A 60 O VS	66253055094	30000	10	£00.00	+++++
A11	22x45	6x40	■ 86A 36 O VS	66253055095	18000	10	£00.00	++++
A12	18x30	6x40	■ 86A 60 P VS	66253055096	30000	10	£00.00	++++
A15	6x25	6x40	■ 86A 90 O VS	66253055126	30000	10	£00.00	++++
A24	6x20	6x40	■ 86A 60 O VS	66253055127	41000	10	£00.00	++++
A25	Ø25	6x40	■ 86A 60 O VS	66253055128	25000	10	£00.00	++++
A36	40x10	6x40	■ 86A 60 O VS	66253055129	25000	10	£00.00	++++
A26	Ø16	6x40	■ 86A 46 O VS	66253055204	54000	10	£00.00	++++
A3	22x70	6x40	■ 86A 60 O VS	66253055212	14000	10	£00.00	++++
A11	21x45	6x40	■ 86A 60 O VS	66253055214	18000	10	£00.00	++++
A1	20x65	6x40	■ 86A 60 O VS	66253055218	15000	10	£00.00	++++
A1	20x65	6x40	■ 86A 36 O VS	66253055235	15000	10	£00.00	++++
A10	22x70	6x40	■ 86A 36 P VS	66253055237	14000	10	£00.00	++++
A11	22x45	6x40	■ 86A 36 O VS	66253055307	18000	10	£00.00	++++
A8	20x50	6x40	■ 86A 36 O VS	66253055308	18000	10	£00.00	++++
A37	30x6	6x40	■ 86A 90 O VS	66253055313	30000	10	£00.00	++++
A9	30x50	6x40	■ 86A 36 P VS	66253055395	13000	10	£00.00	++++
A5	20x28	6x40	■ 38A 60 R 9 VM	69936613862	30000	10	£00.00	+++
A3	22x70	6x40	■ 38A 36 T 6 VM	69936623827	14000	10	£00.00	+++
A11	22x45	6x40	■ 38A 36 T 6 VM	69936623830	18000	10	£00.00	+++
A1	20x65	6x40	■ 38A 60 R 9 VM	69936635216	15000	10	£00.00	+++
A3	22x70	6x40	■ 38A 60 R 9 VM	69936643931	14000	10	£00.00	+++
A11	22x45	6x40	■ 38A 60 R 9 VM	69936643935	18000	10	£00.00	+++
B52	10x20	3x40	■ 3NQ 80 O VS	61463688963	41000	10	£00.00	++++
B97	4x10	3x40	■ 3NQ 80 O VS	61463688964	90000	10	£00.00	++++
B122	Ø10	3x40	■ 3NQ 80 O VS	61463688965	58000	10	£00.00	++++
B131	13x13	3x40	■ 3NQ 80 O VS	61463689939	58000	10	£00.00	++++
B54	6x13	3x40	■ 86A 90 O VS	66253055139	54000	10	£00.00	++++
B97	3x10	3x40	■ 86A 90 O VS	66253055141	90000	10	£00.00	++++
B121	Ø13	3x40	■ 86A 90 O VS	66253055143	58000	10	£00.00	++++
B44	6x10	3x40	■ 86A 90 O VS	66253055183	61000	10	£00.00	++++
B91	13x16	3x40	■ 86A 90 P VS	66253055199	58000	10	£00.00	++++
B123	5x5	3x40	■ 86A 90 O VS	66253055207	73000	10	£00.00	++++
B52	10x20	3x40	■ 86A 90 P VS	66253055232	41000	10	£00.00	++++
B53	6x16	3x40	■ 86A 90 P VS	66253055305	54000	10	£00.00	++++

BONDED ABRASIVES

SHAPE	DIM DxL (mm)	SPINDLE DxL (mm)	SPECIFICATION	ART. NO.	MOS (RPM)	PK QTY	PRICE	QUALITY TIER
B97	4x10	3x40	38A 90 Q 9 VM	69936623856	90000	10	€00.00	+++
B121	Ø13	3x40	38A 90 S 9 VM	69936623857	58000	10	€00.00	+++
B122	Ø10	3x40	38A 90 Q 9 VM	69936623858	58000	10	€00.00	+++
B44	6x10	3x40	38A 90 S 9 VM	69936626239	61000	10	€00.00	+++
B46	3x8	3x40	38A 90 S 9 VM	69936626240	90000	10	€00.00	+++
B123	Ø5	3x40	38A 90 R VM	69936630653	73000	10	€00.00	+++
B52	10x20	3x40	38A 90 S 9 VM	69936643938	41000	10	€00.00	+++
B53	8x16	6x40	38A 90 S 9 VM	69936690891	54000	10	€00.00	+++
C262	16x32	3x40	38A 90 S VM	69936634345	25000	10	€00.00	+++
W154	5x13	3x40	3NQ 80 O VS	61463688966	70000	10	€00.00	++++
W164	6x20	6x40	3NQ 80 O VS	61463688967	41000	10	€00.00	++++
W185	13x13	3x40	3NQ 80 O VS	61463688969	58000	10	€00.00	++++
W188	13x40	6x40	38A 46 S 8 VM	66243451690	20000	10	€00.00	++++
W205	20x25	6x40	86A 46 P VM	66243538896	32000	-	€00.00	++++
W205	20x25	6x40	86A 36 P VS	66253054948	32000	10	€00.00	++++
W196	16x25	6x40	86A 90 P VS	66253054973	35000	10	€00.00	++++
W206	20x32	6x40	86A 60 P VS	66253055013	30000	10	€00.00	++++
W221	25x40	6x40	86A 36 O VS	66253055016	19000	10	€00.00	++++
W238	40x40	6x40	86A 36 P VS	66253055019	12000	10	€00.00	++++
W238	40x40	6x40	86A 60 O VS	66253055065	12000	10	€00.00	++++
W195	16x20	6x40	86A 60 P VS	66253055091	47000	10	€00.00	++++
W177	10x20	6x40	86A 60 Q VBEM	66253055092	41000	10	€00.00	++++
W188	13x40	6x40	86A 90 P VS	66253055131	20000	10	€00.00	++++
W204	20x20	6x40	86A 60 P VS	66253055134	42000	10	€00.00	++++
W205	20x25	6x40	86A 60 P VS	66253055135	32000	10	€00.00	++++
W220	25x25	6x40	86A 60 O VS	66253055136	25000	10	€00.00	++++
W230	32x32	3x40	86A 60 O VS	66253055138	17000	10	€00.00	++++
W144	3x6	3x40	86A 90 O VS	66253055147	90000	10	€00.00	++++
W149	4x6	3x40	86A 90 P VS	66253055150	80000	10	€00.00	++++
W153	5x10	3x40	86A 90 P VS	66253055160	73000	10	€00.00	++++
W154	5x13	3x40	86A 90 O VS	66253055162	70000	10	€00.00	++++
W162	6x10	3x40	86A 60 P VS	66253055166	61000	10	€00.00	++++
W163	6x13	3x40	86A 90 P VS	66253055167	54000	10	€00.00	++++
W171	8x20	3x40	86A 60 P VS	66253055171	41000	10	€00.00	++++
W175	10x10	3x40	86A 90 O VS	66253055173	61000	10	€00.00	+++++
W162	6x10	6x40	86A 90 P VS	66253055206	61000	10	€00.00	++++
W163	6x13	6x40	86A 60 P VS	66253055210	54000	10	€00.00	++++
W230	32x32	6x40	86A 36 O VS	66253055221	17000	10	€00.00	++++
W179	10x32	6x40	86A 60 O VS	66253055223	25000	10	€00.00	++++
W220	25x25	6x40	86A 36 O VS	66253055231	25000	10	€00.00	++++
W170	8x13	6x40	86A 60 P VS	66253055248	54000	10	€00.00	++++
W232	32x50	6x40	86A 60 P VS	66253055300	11000	10	€00.00	++++
W236	40x13	6x40	86A 60 O VS	66253055304	25000	10	€00.00	++++
W176	10x13	6x40	86A 60 P VS	66253055315	54000	10	€00.00	++++
W169	8x10	6x40	86A 60 P VS	66253055398	61000	10	€00.00	++++
W196	16x25	6x40	86A 46 M VBEM	69210449262	35000	20	€00.00	+++
W195	16x20	6x40	38A 90 S VM	69936623840	47000	10	€00.00	+++
W204	20x20	6x40	38A 60 R VM	69936623841	42000	10	€00.00	+++
W220	25x25	6x40	38A 60 R 9 VM	69936623845	25000	10	€00.00	+++
W230	30x30	3x40	38A 60 R 9 VM	69936623849	17000	10	€00.00	+++
W238	40x40	3x40	38A 60 R 9 VM	69936623850	12000	10	€00.00	+++

BONDED ABRASIVES MOUNTED POINTS & WHEELS

GRAIN COLOUR CODE

NQ
 NQ Vit³
 86A/40A
 38A
 39C

SHAPE	DIM DxL (mm)	SPINDLE DxL (mm)	SPECIFICATION	ART. NO.	MOS (RPM)	PK QTY	PRICE	QUALITY TIER
W144	3x6	3x40	38A 90 S 9 VM	69936623859	90000	10	£00.00	+++
W146	3x13	3x40	38A 90 R 9 VM	69936623861	80000	10	£00.00	+++
W149	4x6	3x40	38A 90 S 9 VM	69936623862	80000	10	£00.00	+++
W153	5x10	3x40	38A 90 Q 9 VM	69936623863	73000	10	£00.00	+++
W154	5x13	3x40	38A 90 Q 9 VM	69936623864	70000	10	£00.00	+++
W162	6x10	3x40	38A 60 R 9 VM	69936623866	61000	10	£00.00	+++
W164	6x20	3x40	38A 90 S 9 VM	69936623869	41000	10	£00.00	+++
W176	10x13	6x40	38A 60 R 9 VM	69936623872	54000	10	£00.00	+++
W176	10x13	3x40	38A 90 R 9 VM	69936623873	54000	10	£00.00	+++
W204	20x20	6x40	38A 36 T 6 VM	69936626238	42000	10	£00.00	+++
W177	10x20	6x40	38A 90 S 9 VM	69936626743	41000	10	£00.00	+++
W171	8x20	6x40	38A 90 S 9 VM	69936630875	41000	10	£00.00	+++
W175	10x10	6x40	38A 90 S 9 VM	69936631248	61000	10	£00.00	+++
W197	16x50	6x40	38A 46 S 8 VM	69936631541	18000	10	£00.00	+++
W230	30x30	6x40	38A 36 T 6 VM	69936635225	17000	10	£00.00	+++
W177	10x20	6x40	38A 60 R VM	69936637149	41000	10	£00.00	+++
W176	10x13	6x40	38A 90 S VM	69936637874	54000	10	£00.00	+++
W179	10x30	3x40	38A 60 R 9 VM	69936637875	25000	10	£00.00	+++
W236	40x12	3x40	38A 46 S 8 VM	69936637876	25000	10	£00.00	+++
W162	6x10	6x40	38A 90 S 9 VM	69936637877	61000	10	£00.00	+++
W171	8x20	3x40	38A 90 S 9 VM	69936637878	41000	10	£00.00	+++
W220	25x25	M4M	38A 36 T 6 V	69936643936	25000	10	£00.00	+++
W144	3x6	3x40	5NQ 60 R VS3	66253478595	105000	10	£00.00	+++++
W144	3x6	3x40	5NQ 80 R VS3	66253478592	105000	10	£00.00	+++++
W144	3x6	3x40	5NQ 100 R VS3	66253478593	105000	10	£00.00	+++++
W144	3x6	3x40	5NQ 120 R VS3	66253478594	105000	10	£00.00	+++++
W144	3x6	6x40	5NQ 100 R VS3	66253480442	105000	10	£00.00	+++++
W144	3x6	6x40	5NQ 120 R VS3	66253480444	105000	10	£00.00	+++++
-*	3x8	6x40	5NQ 100 R VS3	66253480445	105000	10	£00.00	+++++
W145	3x10	3x40	5NQ 100 R VS3	66253478596	105000	10	£00.00	+++++
W146	3x13	3x40	5NQ 100 R VS3	66253478597	105000	10	£00.00	+++++
W149	4x6	3x40	5NQ 60 R VS3	66253478599	105000	10	£00.00	+++++
W149	4x6	3x40	5NQ 100 R VS3	66253478598	105000	10	£00.00	+++++
-*	4x8	3x40	5NQ 60 R VS3	66253478600	105000	10	£00.00	+++++
W155	4x8	3x40	39C 80 S VM	66253478601	105000	10	£00.00	+++++
-*	4x8	3x40	5NQ 100 R VS3	66253478602	105000	10	£00.00	+++++
-*	4x8	6x40	5NQ 60 R VS3	66253478997	65000	10	£00.00	+++++
-*	4x8	6x40	5NQ 80 R VS3	66253478998	65000	10	£00.00	+++++
-*	4x8	6x40	5NQ 100 R VS3	66253478999	65000	10	£00.00	+++++
-*	5x6	3x40	5NQ 100 R VS3	66253477241	105000	10	£00.00	+++++
-*	5x8	6x40	5NQ 80 R VS3	66253479000	65000	10	£00.00	+++++
W153	5x10	3x40	5NQ 60 R VS3	66253477243	80000	10	£00.00	+++++
W153	5x10	3x40	39C 80 S VM	66253478603	80000	10	£00.00	+++
W153	5x10	3x40	5NQ 100 R VS3	66253477246	80000	10	£00.00	+++++
W153	5x10	6x40	5NQ 60 R VS3	66253479001	62000	10	£00.00	+++++
W153	5x10	6x40	5NQ 80 R VS3	66253479002	62000	10	£00.00	+++++
W153	5x10	6x40	5NQ 100 R VS3	66253479003	62000	10	£00.00	+++++

*Shape not available in the US ANSI code

SHAPE	DIM DxL (mm)	SPINDLE DxL (mm)	SPECIFICATION	ART. NO.	MOS (RPM)	PK QTY	PRICE	QUALITY TIER
W154	5x13	3x40	5NQ 60 R VS3	66253477248	70500	10	€00.00	*****
W154	5x13	3x40	5NQ 100 R VS3	66253477249	70500	10	€00.00	*****
-*	5x15	3x40	5NQ 60 R VS3	66253477251	70500	10	€00.00	*****
W158	6x3	3x40	5NQ 100 R VS3	66253480308	85000	10	€00.00	*****
W162	6x10	3x40	5NQ 80 R VS3	66253478605	68400	10	€00.00	*****
W162	6x10	3x40	39C 80 S VM	66253478604	68400	10	€00.00	+++
W162	6x10	3x40	5NQ 100 R VS3	66253477259	68400	10	€00.00	*****
W162	6x10	6x40	5NQ 60 R VS3	66253479004	62000	10	€00.00	*****
W162	6x10	6x40	5NQ 80 R VS3	66253479005	62000	10	€00.00	*****
W163	6x13	3x40	5NQ 60 R VS3	66253477264	60000	10	€00.00	*****
W163	6x13	3x40	5NQ 80 R VS3	66253477265	60000	10	€00.00	*****
W163	6x13	3x40	5NQ 100 R VS3	66253477266	60000	10	€00.00	*****
W163	6x13	6x40	5NQ 100 R VS3	66253479006	62000	10	€00.00	*****
W164	6x20	3x40	5NQ 60 R VS3	66253477267	45900	10	€00.00	*****
W164	6x20	3x40	5NQ 100 R VS3	66253477268	45900	10	€00.00	*****
-*	6x25	3x40	5NQ 60 R VS3	66253479396	45900	10	€00.00	*****
-*	7x10	6x40	5NQ 80 R VS3	66253479007	62000	10	€00.00	*****
W165	8x2	3x40	5NQ 100 R VS3	66253480309	61500	10	€00.00	*****
W169	8x10	3x40	5NQ 46 R VS3	66253477269	61500	10	€00.00	*****
W169	8x10	3x40	5NQ 80 R VS3	66253478607	61500	10	€00.00	*****
W169	8x10	3x40	39C 80 R VM	66253478606	61500	10	€00.00	+++
W169	8x10	3x40	5NQ 100 R VS3	66253477271	61500	10	€00.00	*****
W169	8x10	6x40	5NQ 60 R VS3	66253479008	57500	10	€00.00	*****
W169	8x10	6x40	5NQ 80 R VS3	66253479009	57500	10	€00.00	*****
-*	8x12	6x40	5NQ 80 R VS3	66253479010	57500	10	€00.00	*****
W170	8x13	3x40	5NQ 46 R VS3	66253477392	52500	10	€00.00	*****
W170	8x13	3x40	5NQ 80 R VS3	66253477272	52500	10	€00.00	*****
-*	8x16	3x40	5NQ 46 R VS3	66253477393	52500	10	€00.00	*****
-*	8x16	3x40	5NQ 60 R VS3	66253477394	52500	10	€00.00	*****
-*	8x16	3x40	5NQ 80 R VS3	66253477395	52500	10	€00.00	*****
-*	8x16	6x40	5NQ 46 R VS3	66253477396	57500	10	€00.00	*****
-*	8x16	6x40	5NQ 60 R VS3	66253477397	57500	10	€00.00	*****
-*	8x16	6x40	5NQ 80 R VS3	66253477398	57500	10	€00.00	*****
-*	8x20	6x40	5NQ 60 R VS3	66253477399	57500	10	€00.00	*****
-*	9x12	6x40	5NQ 80 R VS3	66253477400	54000	10	€00.00	*****
W172	10x2	3x40	5NQ 60 R VS3	66253480311	35000	10	€00.00	*****
W172	10x2	3x40	5NQ 100 R VS3	66253480314	35000	10	€00.00	*****
W173	10x3	3x40	5NQ 60 R VS3	66253480318	33000	10	€00.00	*****
W173	10x3	3x40	5NQ 100 R VS3	66253480315	33000	10	€00.00	*****
W175	10x10	3x40	5NQ 46 R VS3	66253477401	54000	10	€00.00	*****
W175	10x10	3x40	5NQ 60 R VS3	66253477402	54000	10	€00.00	*****
W175	10x10	3x40	5NQ 80 R VS3	66253478609	54000	10	€00.00	*****
W175	10x10	3x40	39C 80 S VM	66253478608	54000	10	€00.00	+++
W175	10x10	6x40	5NQ 60 R VS3	66253477404	54000	10	€00.00	*****
W175	10x10	6x40	5NQ 80 R VS3	66253477405	54000	10	€00.00	*****
-*	10x12	6x40	5NQ 80 R VS3	66253477406	54000	10	€00.00	*****
W176	10x13	3x40	5NQ 46 R VS3	66253477408	45370	10	€00.00	*****
W176	10x13	3x40	5NQ 80 R VS3	66253477407	45370	10	€00.00	*****
W176	10x13	3x40	5NQ 80 R VS3	66253480919	45370	10	€00.00	*****
W176	10x13	3x40	39C 80 S VM	66253480899	45370	10	€00.00	+++

*Shape not available in the US ANSI code

BONDED ABRASIVES MOUNTED POINTS & WHEELS

GRAIN COLOUR CODE

NQ
 NQ Vit³
 86A/40A
 38A
 39C

SHAPE	DIM DxL (mm)	SPINDLE DxL (mm)	SPECIFICATION	ART. NO.	MOS (RPM)	PK QTY	PRICE	QUALITY TIER
W176	10x13	3x40	5NQ 100 R VS3	66253477410	45370	10	£00.00	+++++
W176	10x13	6x40	5NQ 46 R VS3	66253477412	45370	10	£00.00	+++++
W176	10x13	6x40	5NQ 80 R VS3	66253477413	45370	10	£00.00	+++++
W176	10x13	6x40	39C 80 S VM	66253478610	45370	10	£00.00	+++
W177	10x20	6x40	5NQ 46 R VS3	66253477415	46500	10	£00.00	+++++
W177	10x20	6x40	5NQ 80 R VS3	66253478612	46500	10	£00.00	+++++
W177	10x20	6x40	39C 80 S VM	66253478611	46500	10	£00.00	+++
W178	10x25	6x40	5NQ 46 R VS3	66253477417	40500	10	£00.00	+++++
W178	10x25	6x40	5NQ 80 R VS3	66253477418	40500	10	£00.00	+++++
W179	10x32	6x40	5NQ 46 R VS3	66253477419	33750	10	£00.00	+++++
W179	10x32	6x40	5NQ 80 R VS3	66253477420	33750	10	£00.00	+++++
-*	10x40	6x40	5NQ 46 R VS3	66253477421	33750	10	£00.00	+++++
-*	10x40	6x40	5NQ 60 R VS3	66253477422	33750	10	£00.00	+++++
-*	12x15	6x40	5NQ 80 R VS3	66253477423	33750	10	£00.00	+++++
-*	13x3	3x40	5NQ 60 R VS3	66253480327	28000	10	£00.00	+++++
-*	13x3	3x40	5NQ 100 R VS3	66253480329	28000	10	£00.00	+++++
W185	13x13	3x40	5NQ 46 R VS3	66253478224	34500	10	£00.00	+++++
W185	13x13	3x40	5NQ 60 R VS3	66253478225	34500	10	£00.00	+++++
W185	13x13	3x40	5NQ 80 R VS3	66253478226	34500	10	£00.00	+++++
W185	13x13	6x40	5NQ 46 R VS3	66253478237	42000	10	£00.00	+++++
W185	13x13	6x40	5NQ 60 R VS3	66253478238	42000	10	£00.00	+++++
W186	13x20	6x40	5NQ 60 R VS3	66253478240	36000	10	£00.00	+++++
W186	13x20	6x40	5NQ 80 R VS3	66253478613	36000	10	£00.00	+++++
W186	13x20	6x40	39C 80 S VM	66253478614	36000	10	£00.00	+++
W187	13x25	6x40	5NQ 46 R VS3	66253478244	30000	10	£00.00	+++++
W187	13x25	6x40	5NQ 60 R VS3	66253478246	30000	10	£00.00	+++++
W187	13x25	6x40	5NQ 80 R VS3	66253478248	30000	10	£00.00	+++++
W188	13x32	6x40	5NQ 36 R VS3	66253478255	30000	10	£00.00	+++++
W188	13x32	6x40	5NQ 46 R VS3	66253478256	30000	10	£00.00	+++++
W188	13x32	6x40	5NQ 80 R VS3	66253480917	30000	10	£00.00	+++++
W188	13x32	6x40	39C 80 S VM	66253480918	30000	10	£00.00	+++
-*	13x40	6x40	5NQ 46 R VS3	66253478257	30000	10	£00.00	+++++
-*	16x3	3x40	5NQ 60 R VS3	66253480331	25000	10	£00.00	+++++
-*	16x3	3x40	5NQ 100 R VS3	66253480338	25000	10	£00.00	+++++
-*	16x5	3x40	5NQ 46 R VS3	66253479397	34500	10	£00.00	+++++
-*	16x5	3x40	5NQ 80 R VS3	66253479399	34500	10	£00.00	+++++
-*	16x6	6x40	5NQ 46 R VS3	66253479401	30000	10	£00.00	+++++
W194	16x16	6x40	5NQ 36 R VS3	66253478259	35000	10	£00.00	+++++
W194	16x16	6x40	5NQ 46 R VS3	66253478260	35000	10	£00.00	+++++
W194	16x16	6x40	5NQ 80 R VS3	66253480915	35000	10	£00.00	+++++
W194	16x16	6x40	39C 80 S VM	66253480916	35000	10	£00.00	+++
W195	16x20	6x40	5NQ 36 R VS3	66253479402	32000	10	£00.00	+++++
W195	16x20	6x40	5NQ 36 R VS3	66253478261	32000	10	£00.00	+++++
W195	16x20	6x40	5NQ 80 R VS3	66253480913	32000	10	£00.00	+++++
W195	16x20	6x40	39C 80 S VM	66253480914	32000	10	£00.00	+++
-*	16x32	6x40	5NQ 36 R VS3	66253479403	23000	10	£00.00	+++++
W196	16x32	6x40	5NQ 36 R VS3	66253478616	23000	10	£00.00	+++++

*Shape not available in the US ANSI code

SHAPE	DIM DxDL (mm)	SPINDLE DxDL (mm)	SPECIFICATION	ART. NO.	MOS (RPM)	PK QTY	PRICE	QUALITY TIER
W196	16x32	6x40	39C 36 S VM	66253478615	23000	10	€00.00	+++
W196	16x32	6x40	5NQ 46 R VS3	66253478264	23000	10	€00.00	+++++
W196	16x32	6x40	5NQ 60 R VS3	66253478265	23000	10	€00.00	+++++
W196	16x32	6x40	5NQ 80 R VS3	66253478618	23000	10	€00.00	+++++
W196	16x32	6x40	39C 80 S VM	66253478617	23000	10	€00.00	+++
-*	16x40	6x40	5NQ 36 R VS3	66253478267	23000	10	€00.00	+++++
-*	16x40	6x40	5NQ 46 R VS3	66253478268	23000	10	€00.00	+++++
-*	16x40	6x40	5NQ 60 R VS3	66253478266	23000	10	€00.00	+++++
W197	16x50	6x40	5NQ 36 R VS3	66253478269	20000	10	€00.00	+++++
W197	16x50	6x40	5NQ 60 R VS3	66253478270	20000	10	€00.00	+++++
-*	19x3	3x40	5NQ 60 R VS3	66253480339	38250	10	€00.00	+++++
W201	20x6	3x40	5NQ 46 R VS3	66253478271	38250	10	€00.00	+++++
W201	20x6	3x40	5NQ 80 R VS3	66253478272	38250	10	€00.00	+++++
W201	20x6	6x40	5NQ 46 R VS3	66253478273	50000	10	€00.00	+++++
W201	20x6	6x40	5NQ 80 R VS3	66253478274	50000	10	€00.00	+++++
W202	20x10	6x40	5NQ 36 R VS3	66253478275	44000	10	€00.00	+++++
W202	20x10	6x40	5NQ 60 R VS3	66253478276	44000	10	€00.00	+++++
W203	20x13	6x40	5NQ 36 R VS3	66253478277	35000	10	€00.00	+++++
W204	20x20	6x40	5NQ 36 R VS3	66253478278	30000	10	€00.00	+++++
W204	20x20	6x40	5NQ 80 R VS3	66253480909	30000	10	€00.00	+++++
W204	20x20	6x40	39C 80 S VM	66253480910	30000	10	€00.00	+++
W205	20x25	6x40	5NQ 46 R VS3	66253478279	25000	10	€00.00	+++++
W205	20x25	6x40	5NQ 60 R VS3	66253478280	25000	10	€00.00	+++++
W205	20x25	6x40	5NQ 80 R VS3	66253480911	25000	10	€00.00	+++++
W205	20x25	6x40	39C 80 S VM	66253480912	25000	10	€00.00	+++
W206	20x32	6x40	5NQ 36 R VS3	66253478402	21000	10	€00.00	+++++
W206	20x32	6x40	5NQ 80 R VS3	66253478620	21000	10	€00.00	+++++
W206	20x32	6x40	39C 80 S VM	66253478619	21000	10	€00.00	+++
W207	20x40	6x40	5NQ 36 R VS3	66253478404	20000	10	€00.00	+++++
W207	20x40	6x40	39C 36 S VM	66253478621	20000	10	€00.00	+++
W207	20x40	6x40	5NQ 46 R VS3	66253478406	20000	10	€00.00	+++++
W207	20x40	6x40	5NQ 60 R VS3	66253478407	20000	10	€00.00	+++++
W207	20x40	6x40	5NQ 80 R VS3	66253480907	20000	10	€00.00	+++++
W207	20x40	6x40	39C 80 S VM	66253478405	20000	10	€00.00	+++
W208	20x50	6x40	5NQ 36 R VS3	66253478623	35000	10	€00.00	+++++
W208	20x50	6x40	39C 36 S VM	66253478622	35000	10	€00.00	+++
W215	25x3	3x40	5NQ 100 R VS3	66253480343	35000	10	€00.00	+++++
W216	25x6	6x40	5NQ 46 R VS3	66253479404	35000	10	€00.00	+++++
W216	25x6	6x40	5NQ 80 R VS3	66253479405	35000	10	€00.00	+++++
W217	25x10	6x40	5NQ 36 R VS3	66253478409	35000	10	€00.00	+++++
W217	25x10	6x40	5NQ 60 R VS3	66253478410	35000	10	€00.00	+++++
W218	25x13	6x40	5NQ 36 R VS3	66253478412	30000	10	€00.00	+++++
-*	25x16	6x40	5NQ 60 R VS3	66253478415	30000	10	€00.00	+++++
W220	25x25	6x40	5NQ 36 R VS3	66253478419	30000	10	€00.00	+++++
W221	25x32	6x40	5NQ 36 R VS3	66253478423	30000	10	€00.00	+++++
W221	25x32	6x40	39C 36 S VM	66253478624	30000	10	€00.00	+++
-*	25x32	6x40	5NQ 60 R VS3	66253478431	30000	10	€00.00	+++++
W225	32x6	6x40	5NQ 46 R VS3	66253479395	25000	10	€00.00	+++++
W226	32x8	6x40	5NQ 36 R VS3	66253478433	25000	10	€00.00	+++++
W226	32x8	6x40	5NQ 60 R VS3	66253478435	25000	10	€00.00	+++++

*Shape not available in the US ANSI code

BONDED ABRASIVES MOUNTED POINTS & WHEELS

GRAIN COLOUR CODE

NQ
 NQ Vit³
 86A/40A
 38A
 39C

SHAPE	DIM DxL (mm)	SPINDLE DxL (mm)	SPECIFICATION	ART. NO.	MOS (RPM)	PK QTY	PRICE	QUALITY TIER
-*	32x16	6x40	5NQ 36 R VS3	66253478437	25000	10	£00.00	+++++
-*	32x16	6x40	5NQ 46 R VS3	66253478438	25000	10	£00.00	+++++
W228	32x20	6x40	5NQ 36 R VS3	66253478440	20000	10	£00.00	+++++
W228	32x20	6x40	5NQ 46 R VS3	66253478441	20000	10	£00.00	+++++
W230	32x32	6x40	5NQ 36 R VS3	66253478626	15000	10	£00.00	+++++
W230	32x32	6x40	39C 36 S VM	66253478625	15000	10	£00.00	+++
W230	32x32	6x40	5NQ 46 R VS3	66253478443	15000	10	£00.00	+++++
W230	32x32	6x40	5NQ 80 R VS3	66253480906	15000	10	£00.00	+++++
W230	32x32	6x40	39C 80 S VM	66253478442	15000	10	£00.00	+++
W231	32x40	6x40	5NQ 36 R VS3	66253478444	13000	10	£00.00	+++++
W231	32x40	6x40	5NQ 46 R VS3	66253478447	13000	10	£00.00	+++++
W231	32x40	8x40	5NQ 36 R VS3	66253479391	13000	10	£00.00	+++++
W231	32x40	8x40	39C 36 S VM	66253479390	13001	10	£00.00	+++
W235	40x6	6x40	5NQ 46 R VS3	66253479392	25000	10	£00.00	+++++
W236	40x10	6x40	5NQ 36 R VS3	66253478449	25000	10	£00.00	+++++
W236	40x10	6x40	5NQ 60 R VS3	66253478450	25000	10	£00.00	+++++
-*	40x15	6x40	5NQ 36 R VS3	66253478451	25000	10	£00.00	+++++
-*	40x15	6x40	5NQ 60 R VS3	66253478454	25000	10	£00.00	+++++
W237	40x20	6x40	39C 36 S VM	66253478627	17000	10	£00.00	+++
W237	40x20	6x40	5NQ 36 R VS3	66253478457	17000	10	£00.00	+++++
W237	40x20	6x40	5NQ 46 R VS3	66253478458	17000	10	£00.00	+++++
W237	40x20	6x40	5NQ 80 R VS3	66253480904	17000	10	£00.00	+++++
W237	40x20	6x40	39C 80 S VM	66253481164	17000	10	£00.00	+++
W237	40x20	6x40	39C 46 S VM	66253481165	12000	10	£00.00	+++
W237	40x20	8x40	5NQ 36 R VS3	66253479394	18000	10	£00.00	+++++
W238	40x40	6x40	5NQ 36 R VS3	66253478464	12000	10	£00.00	+++++
W238	40x40	6x40	5NQ 46 R VS3	66253478465	12000	10	£00.00	+++++
W238	40x40	8x40	39C 36 S VM	66253479384	12000	10	£00.00	+++
-*	50x8	6x40	5NQ 36 R VS3	66253480903	15000	10	£00.00	+++++
-*	50x8	6x40	39C 36 S VM	66253478466	15000	10	£00.00	+++
-*	50x13	6x40	5NQ 36 R VS3	66253478467	15000	10	£00.00	+++++
-*	50x13	6x40	5NQ 60 R VS3	66253478468	15000	10	£00.00	+++++
-*	50x13	8x40	5NQ 36 R VS3	66253479382	18000	10	£00.00	+++++
W242	50x20	6x40	5NQ 36 R VS3	66253478469	15000	10	£00.00	+++++
W242	50x20	8x40	5NQ 36 R VS3	66253479381	15000	10	£00.00	+++++
W242	50x25	6x40	5NQ 36 R VS3	66253478470	15000	10	£00.00	+++++
W242	50x25	6x40	5NQ 46 R VS3	66253478471	15000	10	£00.00	+++++
W242	50x25	8x40	5NQ 36 R VS3	66253479380	15000	10	£00.00	+++++
W243	50x40	8x40	5NQ 36 R VS3	66253479379	15000	10	£00.00	+++++
KIT	6MM METRIC NQ KIT		3NQ 80 R VS	61463692247	-	-	£00.00	+++++
KIT	3MM METRIC NQ KIT		3NQ 80 R VS	61463692248	-	-	£00.00	+++++

*Shape not available in the US ANSI code



ORGANIC MOUNTED POINTS

Produced specifically for demanding applications, Norton organic mounted points work harder for you. With stock removal that's twice as fast and product life that's up to four times longer than their conventional aluminium oxide counterparts, organic mounted points increase productivity and clean more parts in less time, reducing your overall process cost.



NZ ORGANIC ++++

Zirconia alumina self-sharpening abrasive and durable organic bond

- Up to 4x faster stock removal than aluminum oxide products for heavy duty operations
- Stable under high cutting pressure
- Designed for large scale removal
- Super long cutting action / long lasting

A ORGANIC +++

Brown aluminium oxide, tougher than pure white aluminium oxide abrasive

- Good cutting performance on medium to soft steels
- Suitable for carbon steel, HSS and alloyed steel



Use "A" shapes for medium to heavy duty blending
Use "W" shapes for off hand and precision grinding of medium to heavy stock.

BONDED ABRASIVES MOUNTED POINTS & WHEELS

GRAIN COLOUR CODE

■ NZ ■ A

SHAPE	DIM DxL (mm)	SPINDLE DxL (mm)	SPECIFICATION	ART. NO.	MOS (RPM)	PK QTY	PRICE	QUALITY TIER
A1	20x65	6x40	■ 3N10Z24UBXR1	61463689077	15000	10	€00.00	++++
A3	22x70	6x40	■ 3N10Z24UBXR1	61463689079	14000	10	€00.00	++++
A5	20x28	6x40	■ 3N10Z24UBXR1	61463689081	30000	10	€00.00	++++
W177	10x20	6x40	■ 3N10Z24UBXR1	61463689084	66000	10	€00.00	++++
W178	10x25	6x40	■ 3N10Z24UBXR1	61463689085	55200	10	€00.00	++++
W189	13x50	6x40	■ 3N10Z24UBXR1	61463689089	30370	10	€00.00	++++
W188	13x40	6x40	■ 3N10Z24UBXR1	61463689090	30370	10	€00.00	++++
W204	20x20	6x40	■ 3N10Z24UBXR1	61463689091	42750	10	€00.00	++++
W205	20x25	6x40	■ 3N10Z24UBXR1	61463689093	34500	10	€00.00	++++
W207	20x40	6x40	■ 3N10Z24UBXR1	61463689095	24000	10	€00.00	++++
W220	25x25	6x40	■ 3N10Z24UBXR1	61463689097	25500	10	€00.00	++++
W230	30x30	6x40	■ 3N10Z24UBXR1	61463689099	24000	10	€00.00	++++
W236	40x12	6x40	■ 3N10Z24UBXR1	61463689100	25130	10	€00.00	++++
W188	13x40	6x40	■ A 36 Q 4 B	66253053225	30370	20	€00.00	+++
W220	25x25	6x40	■ A 46 Q 4 B	66253053237	25500	20	€00.00	+++
W221	25x40	6x40	■ A 46 Q 4 B	66253053243	19120	20	€00.00	+++
W230	32x32	6x40	■ A 36 Q 4 B	66253053250	24000	20	€00.00	+++
W236	40x13	6x40	■ A 46 Q 4 B	66253053251	25130	20	€00.00	+++
KIT	6mm METRIC NZ		■ NZ	66253145961	-	-	€00.00	+++++



A collection of five Norton dressing sticks and sharpening stones in various colors: light blue, white, dark blue, orange, and dark grey. They are arranged in a scattered, overlapping manner on a light-colored surface. The Norton logo is in the top right corner, and the Saint-Gobain name is below it. A vertical green bar on the right edge contains the text 'BONDED ABRASIVES'.

NORTON

SAINT-GOBAIN®

DRESSING STICKS & SHARPENING STONES

DRESSING STICKS & SHARPENING STONES 261-270

Dressing sticks	262
Bench & combination oil stoness	264
Abrasive & precision files	266
Abrasive slips and specialties	269
Reinforced wheels	274



DRESSING STICKS

Norton dressing sticks are designed to help you achieve maximum performance from your vitrified wheels. Use for truing, cleaning, and dressing diamond, CBN and conventional abrasive wheels.

NORBIDE **+++++**

- Manufactured from sintered boron carbide
- Extremely hard & very dense
- Excellent chemical & wear resistance
- Long product life, reduced maintenance & less downtime
- Suitable also for dressing tool & cutter wheels 200mm & smaller, especially cup & dish shapes

SHAPE	DIM WxHxL (mm)	SPECIFICATION	PK QTY	ART. NO.	PRICE
RECTANGULAR	5x12,7x76,2	NORBIDE	1	61463610148	€00.00



39C **++++**

- Highest purity green silicon carbide abrasive
- Harder & more friable than aluminium oxide abrasive
- Ideal for dressing conventional vitrified grinding wheels
- Outperforms 37C for better cutting efficiency & longer life

SHAPE	DIM WxHxL (mm)	SPECIFICATION	PK QTY	ART. NO.	PRICE
RECTANGULAR	25x50x200	39C 60 KV	1	69936685066	€00.00



37C

- High purity black silicon carbide abrasive
- Harder & more friable than aluminium oxide abrasive
- Ideal for dressing conventional vitrified grinding wheels

SHAPE	DIM WxHxL/DIAxL (mm)	SPECIFICATION	PK QTY	ART. NO.	PRICE
DRESSING STICKS FOR SUPER ABRASIVE GRINDING WHEELS					
SQUARE	13x13x150	37C 80 MV	10	69936685063	€00.00
		37C 320 HV	10	66243453547	€00.00
DRESSING STICKS FOR BONDED ABRASIVE GRINDING WHEELS					
RECTANGULAR	25x50x200	37C 24 TV	10	69936685072	€00.00
SQUARE	25x25x150	37C 30 UV	10	69936624620	€00.00
ROUND	25,4x203,2	37C 30 TV	10	61463625024	€00.00



38A

- High purity white aluminium oxide abrasive
- Friable abrasive
- Ideal for dressing CBN Super Abrasive wheels

SHAPE	DIM WxHxL (mm)	SPECIFICATION	PK QTY	ART. NO.	PRICE
DRESSING STICKS FOR SUPER ABRASIVE GRINDING WHEELS					
RECTANGULAR	13x25x150	38A 150 HVBE	10	61463605565	€00.00
		38A 220 HVBE	10	61463605066	€00.00
		38A 320 HVBE	10	69936684889	€00.00
SQUARE	13x13x150	38A 220 HVS	10	69936682631	€00.00
		38A 150 IVBE	10	69936682314	€00.00
	20x20x200	38A 150 HVBE	10	69936685064	€00.00
		38A 220 IVBE	10	61463603606	€00.00
		GENERAL PURPOSE DRESSING STICKS			
RECTANGULAR	13x25x150	38A 220 KV	10	66243460886	€00.00



Use 38A dressing sticks to dress CBN wheels
Use 37C dressing sticks to dress Diamond wheels.



BENCH & COMBINATION OIL STONES

Since 1823, Norton has been the leading supplier of benchstones, files, slips and rubbing bricks. Our comprehensive line of sharpening and finishing stones delivers superior performance solutions.

PRODUCT SELECTION

APPLICATION	COARSE / MEDIUM SHARPENING	FINE STONING
Carbide tool	Medium & coarse, Crystolon Bench	Fine Crystolon Bench
	Coarse/fine Crystolon, Combination	Coarse/fine Crystolon Combination
Steel tool	Medium & coarse India Bench	Fine India Bench
	Coarse/fine India Combination	Coarse/fine India Combination

CRYSTOLON

- Premium silicon carbide abrasive
- Pre-filled with oil
- Fast cutting stone; ideal for general sharpening of cutting tools
- Fast stock removal for quick edge shaping with minimal loading
- Saves time by eliminating the need for pre-soaking prior to use

DIM LxWxH (mm)	TYPE	SPECIFICATION	PK QTY	ART. NO.	PRICE
BENCH STONES					
102x25x13	MJB24	Medium Crystolon	5	61463685480	£00.00
152x51x25	MJB6	Medium Crystolon	5	61463685505	£00.00
	FJB6	Fine Crystolon	5	61463685500	£00.00
COMBINATION OIL STONES					
102x44x16	JB134	Coarse/Fine Crystolon	5	61463685440	£00.00
127x51x19	JB45	Coarse/Fine Crystolon	5	61463685445	£00.00
152x51x25	JB6	Coarse/Fine Crystolon	5	61463685450	£00.00
203x51x25	JB8	Coarse/Fine Crystolon	5	61463685455	£00.00



INDIA

- Smooth cutting aluminium oxide abrasive
- Norton's trademark for a fine finish
- Pre-filled with oil
- Long lasting cutting edge
- Ideal for cleaning, deburring & good quality finishes
- Saves time by eliminating the need for pre-soaking prior to use

DIM LxWxH (mm)	TYPE	SPECIFICATION	PK QTY	ART. NO.	PRICE
BENCH STONES					
102x25x6	MB14	Medium India	5	61463685575	€00.00
	FB14	Fine India	5	61463685570	€00.00
102x25x13	CB24	Coarse India	5	61463685595	€00.00
	MB24	Medium India	5	61463685590	€00.00
	FB24	Fine India	5	61463685585	€00.00
102x44x13	MB124	Medium India	5	61463626048	€00.00
152x38x13	MB26	Medium India	5	61463626034	€00.00
152x51x19	UPB6	Medium India	5	61463690694	€00.00
152x51x25	CB6	Coarse India	5	61463685620	€00.00
	MB6	Medium India	5	61463685615	€00.00
	FB6	Fine India	5	61463685610	€00.00
203x51x25	CB8	Coarse India	5	61463685635	€00.00
	UPB8	Medium India	5	61463685755	€00.00
	MB8	Medium India	5	61463685630	€00.00
	FB8	Fine India	5	61463685625	€00.00
COMBINATION OIL STONES					
102x25x13	IB24	Coarse/Fine India	5	61463626001	€00.00
102x44x16	IB134	Coarse/Fine India	5	61463685550	€00.00
127x51x19	IB45	Coarse/Fine India	5	61463685555	€00.00
152x51x25	IB6	Coarse/Fine India	5	61463685560	€00.00
152x64x25	IB20	Coarse/Fine India	5	61463626103	€00.00
178x51x25	IB7	Coarse/Fine India	5	61463690647	€00.00
203x51x25	IB8	Coarse/Fine India	5	61463625078	€00.00



ARKANSAS

- Natural premium Novaculite quarried in Arkansas & available in soft & hard
- Dense construction
- Sharpest possible razor edges
- Near mirror finishes
- Use for finer honing after India stone
- Absorbs oil at a slower rate, hence does not require pre-filling

DIM LxWxH (mm)	TYPE	SPECIFICATION	PK QTY	ART. NO.	PRICE
BENCH STONES					
102x25x10	HB14	Hard Arkansas	5	61463687555	€00.00
	SB14	Soft Arkansas	5	61463687565	€00.00
152x51x19	HB6	Hard Arkansas	5	61463685660	€00.00





ABRASIVE & PRECISION FILES

Norton abrasive files hold their shape while imparting the finest, most uniform finish on precision machine parts, and in tool and die making.

PRODUCT SELECTION

APPLICATION	COARSE / MEDIUM SHARPENING	FINE STONING	FINISH HONING
Carbide tool	Medium Crystolon square	-	-
Centre punches	Medium India triangle	Fine India triangle	-
Countersinks	Coarse/medium India triangle	Fine India triangle	Hard Arkansas triangle
Form cutter	Coarse/medium India knife blade	Fine India knife blade	Hard Arkansas knife blade
Keyways	Coarse/medium India square	Fine India square	Hard Arkansas square
Lathe bits	-	Fine India square	Hard Arkansas square
Machine knife stone	Coarse Crystolon machine knife	-	-
Magnetic chucks	-	India round	-
Pointed	Medium India pointed	-	Hard Arkansas pointed
Precision machine knife	Medium India half round	Fine India half round	-
Radius tools	Medium India round	Fine India round	Hard Arkansas round
Router bits	-	Fine India square	-
Silversmith	Medium India Silversmith	Fine India Silversmith	-
Tap threads	-	Fine India triangle	-

CRYSTOLON

- Premium silicon carbide abrasive
- Fast cutting
- Ideal for general sharpening

SHAPE	DIM LxH (mm)	TYPE	SPECIFICATION	PK QTY	ART. NO.	PRICE
SQUARE	152x25	MJF76	Medium Crystolon	5	61463625039	£00.00
TRIANGLE	152x13	MJF146	Medium Crystolon	5	61463625043	£00.00



INDIA

- Smooth cutting aluminium oxide abrasive
- Ideal when a close tolerance is more important than the speed of cut

DIM LxDIA (mm)	TYPE	SPECIFICATION	PK QTY	ART. NO.	PRICE
ABRASIVE FILES					
ROUND					
102x3	FF212	Fine India	5	61463626076	£00.00
102x6	MF214	Medium India	5	61463686475	£00.00
	FF214	Fine India	5	61463686470	£00.00
102x10	MF234	Medium India	5	61463686490	£00.00
	FF234	Fine India	5	61463686485	£00.00
102x13	MF244	Medium India	5	61463686505	£00.00
	FF244	Fine India	5	61463686500	£00.00
152x10	FF236	Fine India	5	61463626106	£00.00
152x13	MF246	Medium India	5	61463686520	£00.00
152x16	MF256	Medium India	5	61463686535	£00.00
	FF256	Fine India	5	61463686530	£00.00
152x19	MF266	Medium India	5	61463686550	£00.00
HALF ROUND					
102x10	MF334	Medium India	5	61463686385	£00.00
102x13	MF344	Medium India	5	61463686400	£00.00
	FF344	Fine India	5	61463686395	£00.00
SQUARE					
102x6	FF14	Fine India	5	61463686065	£00.00
	MF14	Medium India	5	61463686070	£00.00
102x10	FF34	Fine India	5	61463686080	£00.00
	MF34	Medium India	5	61463686085	£00.00
	CF34	Coarse India	5	61463686090	£00.00
102x13	CF44	Coarse India	5	61463686105	£00.00
	FF44	Fine India	5	61463686095	£00.00
	MF44	Medium India	5	61463686100	£00.00
152x10	FF36	Fine India	5	61463626037	£00.00
	MF36	Medium India	5	61463626038	£00.00
152x13	FF46	Fine India	5	61463686110	£00.00
	MF46	Medium India	5	61463686115	£00.00
152x16	FF56	Fine India	5	61463686125	£00.00
	MF56	Medium India	5	61463686130	£00.00
152x19	CF66	Coarse India	5	61463686150	£00.00
	FF66	Fine India	5	61463686140	£00.00
	MF66	Medium India	5	61463686145	£00.00
152x25	FF76	Fine India	5	61463686155	£00.00



BONDED ABRASIVES DRESSING STICKS & SHARPENING STONES

DIM LxH (mm)	TYPE	SPECIFICATION	PK QTY	ART. NO.	PRICE
TRIANGLE					
102x6	MF114	Medium India	5	61463686235	£00.00
	FF114	Fine India	5	61463686230	£00.00
102x8	MF124	Medium India	5	61463626027	£00.00
	FF124	Fine India	5	61463626028	£00.00
102x10	MF134	Medium India	5	61463686250	£00.00
	FF134	Fine India	5	61463686245	£00.00
102x13	CF144	Coarse India	5	61463686270	£00.00
	MF144	Medium India	5	61463686265	£00.00
	FF144	Fine India	5	61463686260	£00.00
152x10	MF136	Medium India	5	61463626090	£00.00
	FF136	Fine India	5	61463626054	£00.00
152x13	MF146	Medium India	5	61463686280	£00.00
	FF146	Fine India	5	61463686275	£00.00
152x16	MF156	Medium India	5	61463686295	£00.00
	FF156	Fine India	5	61463686290	£00.00
152x19	MF166	Medium India	5	61463686310	£00.00
	FF166	Fine India	5	61463686305	£00.00
152x25	MF176	Medium India	5	61463686325	£00.00
203x19	MF180	Medium India	5	61463626130	£00.00
	FF180	Fine India	5	61463626082	£00.00
PRECISION FILES					
KNIFE BLADE FILES					
102x25x3	MF724	Medium India	5	61463686775	£00.00
	FF724	Fine India	5	61463686770	£00.00
SILVERSMITH FILES					
102x13x2	FF444	Fine India	5	61463686955	£00.00
	MF444	Medium India	5	61463686960	£00.00

ARKANSAS ABRASIVE FILES

- Hard Novaculite abrasive quarried in Arkansas
- Produces a highly polished finish
- Produces the finest edge possible while maintaining tolerances unequalled by any other abrasive

DIM LxDIA/LxH (mm)	TYPE	SPECIFICATION	PK QTY	ART. NO.	PRICE
HALF ROUND					
76x6	HB14	Hard Arkansas	5	61463686800	£00.00
SQUARE					
76x6	HF13	Hard Arkansas	5	61463686590	£00.00
76x10	HF33	Hard Arkansas	5	61463686595	£00.00
76x13	HF43	Hard Arkansas	5	61463686600	£00.00
TRIANGLE					
76x6	HF113	Hard Arkansas	5	61463686620	£00.00
76x10	HF133	Hard Arkansas	5	61463686625	£00.00
76x13	HF143	Hard Arkansas	5	61463686630	£00.00





ABRASIVE SLIPS & SPECIALTIES

Norton abrasive slips and specialty stones impart the finest, most uniform finish on a wide range of tools. These fast acting slips hold their shape and are long lasting.

PRODUCT SELECTION

APPLICATION	COARSE / MEDIUM SHARPENING	FINE STONING	FINISH HONING
Carbide tools	Medium & Crystolon round edge slip	Fine Crystolon round edge slip	-
	Coarse or medium Crystolon carbide tool slip	Fine Crystolon carbide tool slip	-
Gouges (wood)	-	Fine India gouge Sharpening stone	-
Leather	Medium Crystolon Tradesmen	-	-
Milling cutter	Medium India round edge slip	Fine India round edge slip	Hard Arkansas round edge slip
Pen knife	-	-	Arkansas pen knife
Reamers	Medium India reamer stone	Fine India reamer stone	-
Scythe stone	Scythe stone	-	-
Steel tool	-	-	Rubber stick

SHAPE	DIM LxWxH (mm)	TYPE	SPECIFICATION	PK QTY	ART. NO.	PRICE
SPECIALTY STONES						
SCYTHE STONE	240x35x13	TJ4	Scythe Stone	10	69936693133	£00.00
	254x32x19	JT930	Scythe Stone	5	61463687675	£00.00
RUBBER STICK	200x10x20	-	A240FR96	5	69936625667	£00.00

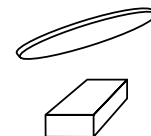

BONDED ABRASIVES DRESSING STICKS & SHARPENING STONES

CRYSTOLON

- Premium silicon carbide abrasive
- Fast cutting stone; ideal for general sharpening of cutting tools
- Fast stock removal for quick edge shaping with minimal loading

SHAPE	DIM LxWxH/DIAxH (mm)	TYPE	SPECIFICATION	PK QTY	ART. NO.	PRICE
SLIP STONES						
CARBIDE TOOL	89x19x13	FJT63	Fine Crystolon	5	61463687285	€00.00
ROUND EDGE	114x44x6	FJS24	Fine Crystolon	5	61463687075	€00.00
SPECIALTY STONES						
RUBBING BRICK	203x51x51	BF28	Hand Crystolon	5	61463687845	€00.00
	203x89x38	235	Fluted Crystolon	5	61463687795	€00.00
MACHINE KNIFE STONE	102x38	JB74	Coarse Crystolon	5	61463687570	€00.00



INDIA

- Smooth cutting aluminium oxide abrasive
- Norton's trademark for a fine finish
- Ideal when a close tolerance is more important than the speed of cut

SHAPE	DIM LxWxH (mm)	TYPE	SPECIFICATION	PK QTY	ART. NO.	PRICE
SLIP STONES						
ROUND EDGE	102x25x11	MS14	Medium India	5	61463687140	€00.00
		FS14	Fine India	5	61463687135	€00.00
	114x44x6	MS24	Medium India	5	61463687150	€00.00
		FS24	Fine India	5	61463687145	€00.00
	114x44x10	MS34	Medium india	5	61463687165	€00.00
		FS34	Fine India	5	61463687160	€00.00
	114x44x13	MS44	Medium India	5	61463687180	€00.00
		FS44	Fine India	5	61463687175	€00.00
SPECIALTY STONES						
REAMER STONES	127x25x5	MT125	Medium India	5	61463687430	€00.00



ARKANSAS

- Natural premium Novaculite quarried in Arkansas & available in soft & hard
- Sharpest possible razor edges
- Near mirror finishes
- Use for finer honing after India stone

SHAPE	DIM LxWxH (mm)	TYPE	SPECIFICATION	PK QTY	ART. NO.	PRICE
SLIP STONES						
ROUND EDGE	102x32x6	HS14	Hard Arkansas	5	61463687050	€00.00
CARVING TOOL	57x22x5	AS22	Hard Arkansas ultra-fine	5	61463687255	€00.00





NORTON

SAINT-GOBAIN®

BONDED
ABRASIVES

ORGANIC WHEELS & CUPS FOR SNAGGING

ORGANIC WHEELS & CUPS FOR SNAGGING 271-272

Snagging wheels

272

Snagging cups

272

ORGANIC WHEELS & CUPS FOR SNAGGING

Norton offers a range of products for portable snagging foundry applications. Type 01 straight wheels are used on portable machines and Type 06 and 11 cup wheels on vertical grinders. Since finish tolerances are not usually critical, coarse, durable wheels are used with grit sizes ranging from 16 to 24.



ZF7A / 25ZF **++++**

Special design of abrasive blends

- Very durable for heavy duty grinding
- Excellent wheel life & metal removal rates
- Ideal for all steels and non-ferrous metals

A **+++**

Tougher than pure white aluminium oxide abrasive

- General purpose abrasive ideal for most operations
- Good wheel life, limited metal removal rate
- Good for cutting medium to soft steels
- Suitable price/performance ratio
- First choice for less technical applications

37C **+++**

Low purity black silicon carbide abrasive

- Harder & more friable than aluminium type abrasives
- Suitable for roughing operations in coarse grit & resinoid wheels
- Ideal for grinding & sharpening applications on metal carbide & non-ferrous metals
- Ideal for applications with no technical requirement

39C **+++**

Highest purity green silicon carbide abrasive

- High cut rate/power on special alloys and titanium
- Extremely friable abrasive for better cutting efficiency & cut quality

Rim Width
Back Thickness
Steels
Non-Ferrous metals
Cast iron

PRODUCT RECOMMENDATION

Highly recommended ●
Recommended ○

WHEELS										
DIM DxTxH (mm)	W	E	Materials		SPECIFICATION	MOS (m/s)	PK QTY	ART. NO.	PRICE	QUALITY TIER
50x13x10			●	○	A 24 TB	50	10	66253057649	€00.00	+++
100x20x20	-	-	●	○	A 24 RB	50	10	66253057660	€00.00	+++
125x50x14	14	-	●	○	A20MB5	50	10	66243570663	€00.00	+++
400x50x127	-	-	●	○	A 24 Q5B3	50	1	69210431446	€00.00	+++
508x50x50	-	-	●	○	ZF7A 16 R5B3	50	1	66253057670	€00.00	+++++
508x60x127	-	-	●	○	ZF7A 16 Q5B3	50	1	66243453103	€00.00	+++++
	-	-	●	○	ZF7A 16 R5B3	50	1	66253057671	€00.00	+++++
	-	-	●	○	ZF7A 20 QB3	50	1	66253057673	€00.00	+++++
760x80x304,8			●	○	ZF7A 14 3RB28	50	1	66253057675	€00.00	+++++

CUPS										
DIM DxTxH (mm)	W	E	Materials		SPECIFICATION	MOS (m/s)	PK QTY	ART. NO.	PRICE	QUALITY TIER
100x20x20	14	20	●	○	A 24 PB	50	20	66253057663	€00.00	+++
125x50xM14	25	20	○	○	37C16N5B5	50	1	69210432282	€00.00	+++
	40	20	○	○	37C16N5B5	50	1	69210432287	€00.00	+++



NORTON

SAINT-GOBAIN®

STRAIGHT CUT-OFF WHEELS

Non-Reinforced wheels
Reinforced wheels

274
274

BONDED ABRASIVES STRAIGHT NON-REINFORCED & REINFORCED CUT-OFF WHEELS

STRAIGHT NON-REINFORCED & REINFORCED CUT-OFF WHEELS

Reinforced cut-off wheels contain fiberglass to increase mechanical resistance when in use. The reinforcements increase the lateral stress capacity, resulting in higher resistance to breakage.

Non-reinforced cut-off wheels are only designed for use on fixed base machines, where the work is securely clamped, the wheel is adequately guarded and operating on a controlled cutting plane. They are suitable for use in dry or wet conditions, depending on bond type.



XGP



Special combination of abrasive blends

- High durability with good cutting capability
- Very long wheel life & high metal removal rate
- Perfect for lab applications
- Suitable for use on all types of steel

4NZ



High concentration of zirconia oxide abrasive

- Extremely tough aluminium oxide abrasive
- Very long wheel life
- Very high cutting capability & high metal removal rate if high pressure is applied
- Perfect for technical applications

39C



Highest purity green silicon carbide abrasive

- Harder & more friable than aluminium oxide abrasive
- Excellent to cut all non metals (titanium, aluminum, bronze)
- Extremely friable abrasive for better cutting efficiency & cut quality

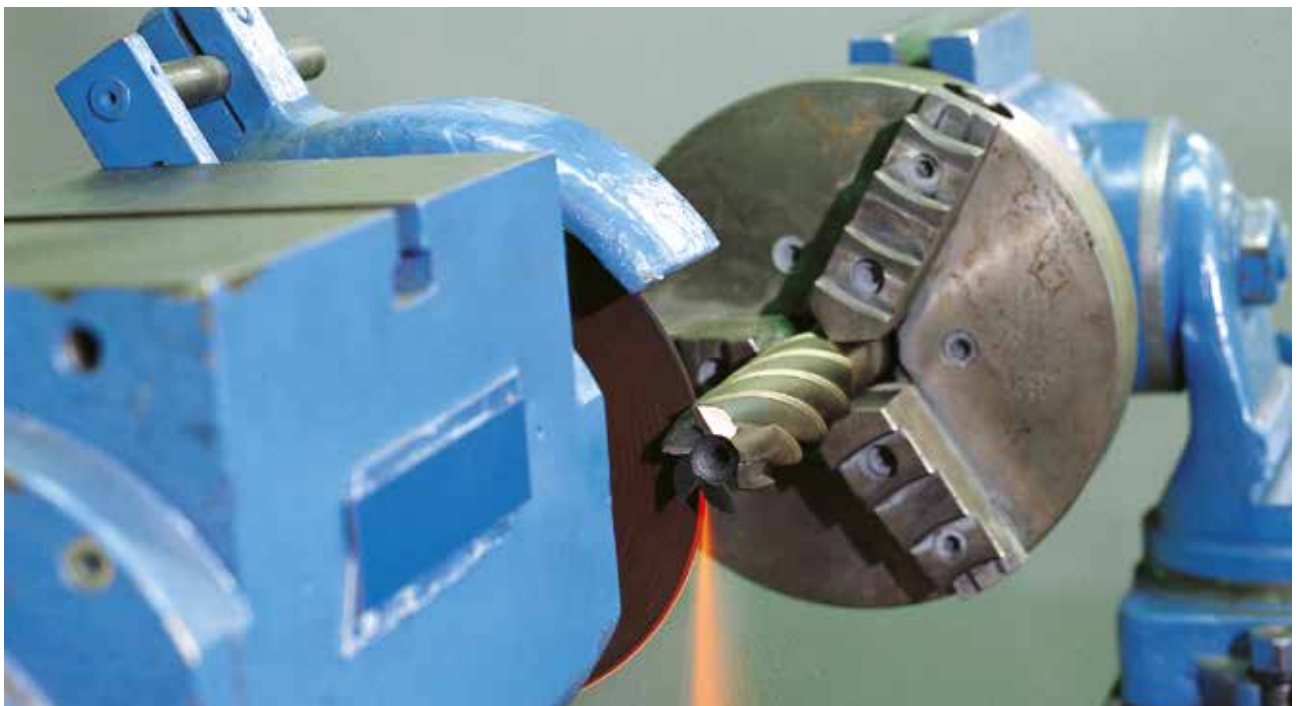



NZ



Latest generation of Norzon grain with finer structure and sharper shape combined with Foundry X bond technology

- Excellent micro-fracturing properties
- Greater heat resistance
- Longer wheel life. Lower total abrasive cost
- Improved cut rate
- Reduced cycle time



U57A



Specially treated brown aluminium oxide abrasive

- Tough & hard aluminium oxide abrasive
- Not suitable for use on extremely hard materials
- Long wheel life
- Ideal for heavy duty applications



57A



Semi-friable aluminium oxide abrasive

- Less tough than type A abrasive but offers better cutting quality with a pointed shape
- Cool & burn free cutting
- Ideal for heat-sensitive applications with light to moderate feed rates
- Good compromise between cut quality & wheel life
- Very versatile: suitable for all steels



23A



An abrasive blend of semi-friable 57A aluminium oxide & white monocristalline 32A aluminium oxide

- Cool & burn free cutting
- Suitable for all steels
- Improved metal removal rate compared to 57A pure semifriable aluminium oxide abrasive



A



Pure brown aluminium oxide abrasive

- The toughest aluminum oxide abrasive
- Long wheel life, limited metal removal rate
- Good for cutting medium to soft steels
- Suitable price/performance position
- First choice for less technical applications

BONDED ABRASIVES STRAIGHT NON-REINFORCED & REINFORCED CUT-OFF WHEELS

SHAPE KEY



DIM DxTxH (mm)	SHAPE	MATERIALS			SPECIFICATION	MOS (m/s)	PK QTY	ART. NO.	PRICE	QUALITY TIER
		High alloyed steels & HSS	Soft steels	Inox						

PRODUCT RECOMMENDATION

Highly recommended ●
Recommended ○

NON-REINFORCED										
100x1x13	41	○	●	○	57A60PB25	80	25	66253056355	€00.00	+++
100x1x20	41	○	●	●	23A80PB25	80	25	66253056356	€00.00	+++
125x1,6x20	41	○	●	○	57A60PB25	80	25	69936625774	€00.00	+++
125x1x16	41	○	●	●	23A80PB25	80	25	66253056358	€00.00	+++
125x1x20	41	○	●	○	57A60PB25	80	25	66253056359	€00.00	+++
150x1x13	41	○	●	●	23A80PB25	80	25	66253056361	€00.00	+++
150x1x16	41	○	●	●	23A80PB25	80	25	66253056363	€00.00	+++
150x1x20	41	○	○	●	23A80NB25	80	25	66253056367	€00.00	+++
150x1x32	41	○	●	○	57A60PB25	80	25	66253056373	€00.00	+++
150x1,6x16	41	○	○	●	23A60NB25	80	25	66253056362	€00.00	+++
150x1,6x20	41	●	○	○	23A60LB25	63	25	66253056365	€00.00	+++
	41	○	●	○	57A60PB25	80	25	66253056364	€00.00	+++
	41	○	○	●	23A60NB25	80	25	66253056366	€00.00	+++
150x1,6x25,4	41	○	●	○	57A60PB25	80	25	69936626781	€00.00	+++
150x1,6x30	41	○	○	●	23A60NB25	80	25	66243452943	€00.00	+++
150x1,6x32	41	○	●	○	57A60PB25	80	25	66253056372	€00.00	+++
	41	○	●	○	57A60NB25	80	25	66253056360	€00.00	+++
150x2x20	41	○	●	○	23A60NB25	80	25	66253056370	€00.00	+++
150x2x32	41	○	●	○	57A60PB25	80	25	66253056369	€00.00	+++
150x2,5x30	41	○	○	●	23A60NB25	80	25	66243452949	€00.00	+++
150x3x32	41	○	●	○	57A60PB25	80	20	66253056374	€00.00	+++
180x1,6x31,75	41	○	●	○	57A60PB25	80	25	66253056375	€00.00	+++
	41	○	●	○	57A60RB25	80	25	66253056376	€00.00	+++
180x1x31,75	41	○	●	○	57A60RB25	80	25	69936625781	€00.00	+++
180x1,6x32	41	○	●	○	57A60PB25	80	25	69936691397	€00.00	+++
200x1,6x20	41	○	●	○	57A60PB25	80	25	66253056377	€00.00	+++
200x1,6x32	41	○	●	○	57A60NB25	80	25	66253056382	€00.00	+++
	41	○	●	○	57A60PB25	80	25	66253056380	€00.00	+++
200x2x20	41	●	○	○	23A60LB25	63	25	66253056378	€00.00	+++
200x2x25,4	41	○	●	○	57A60PB25	80	25	66253056379	€00.00	+++
200x2x32	41	○	●	○	57A60PB25	80	25	69936631641	€00.00	+++
250x1,6x25,4	41	○	●	○	A60NBTOROS	80	10	66253056383	€00.00	+++

PRODUCT RECOMMENDATION

Highly recommended ●
Recommended ○

High alloyed steels & HSS
Soft steels
Inox
Non-Ferrous

DIM DxTxH (mm)	SHAPE	MATERIALS				SPECIFICATION	MOS (m/s)	PK QTY	ART. NO.	PRICE	QUALITY TIER
250x1,6x32	41	●	○	○		XGP70FB26 (TOROS)	63	10	66253060410	€00.00	+++++
	41	●	○	○		XGP70HB26 (TOROS)	63	0	66253060411	€00.00	+++++
	41	●	○	○	○	XGP70EB26 (TOROS)	63	10	66253060409	€00.00	+++++
	41	●	○	○		XGP70JB26 (TOROS)	63	10	66253060412	€00.00	+++++
300x2x32	41	●	○	○	○	XGP70EB26 (TOROS)	63	10	66253060418	€00.00	+++++
	41	●	○	○		XGP70FB26 (TOROS)	63	10	66253060417	€00.00	+++++
350x2,5x32	41	○	○	○	●	XGP70HBB26 (TOROS)	63	0	66253060421	€00.00	+++++
	41	●	○	○		XGP70FB26 (TOROS)	63	10	66253060420	€00.00	+++++
400x3x32	41	●	○	○		XGP60FBB26 (TOROS)	63	10	66253060424	€00.00	+++++
450x3,5x32	41	●	○	○		XGP60EB26 (TOROS)	63	10	66253060428	€00.00	+++++
REINFORCED											
150x1,6x20	41	○	○	●		U57A60QB25	80	25	66253056384	€00.00	++++
200x2x32	41	○	○	●		U57A60OB25	80	25	66253056386	€00.00	++++
350x3,5x25,4	41	○	●	○		NZ30TBFX (Foundry X)	80	10	66253385709	€00.00	+++++
	41	○	○	●		4NZ30TB65 (TOROS)	80	10	66253059172	€00.00	+++++
400x4,5x40	41		●	○		57A24PB25	80	10	66253059176	€00.00	+++
500x5x25,4	41		●	○		57A24TB25-RC26	80	5	66253056529	€00.00	+++
500x5,5x25,4	41		○	●		4NZ30XB25	80	10	66253056535	€00.00	+++++
	41		●	○		57A24PB25	80	5	66253056533	€00.00	+++
	41		○	●		A24TBFX (Foundry X)	80	5	66253386805	€00.00	++++
	41	○	●	○		NZ24TBFX (Foundry X)	80	10	66253386806	€00.00	+++++
	41		●	○		57A24RB25	80	5	66253056536	€00.00	+++
500x5,5x40	41	●	○	○		A24TBF (TOROS)	100	10	66253056534	€00.00	++++
	41	○	●	○		NZ24TBFX (Foundry X)	80	10	66253372433	€00.00	+++++
	41		○	●		A24TBFX (Foundry X)	80	5	66253372432	€00.00	++++
500x6x76,2	42		○	●		U57A20RB25	80	10	66253056538	€00.00	+++
	42		○	●		4NZ24ZB25	80	10	66253056539	€00.00	+++++
600x6,5x60	41		○	●		A24TBFX (Foundry X)	100	5	66253372434	€00.00	++++
	41		●	○		57A24PB25-RC12	100	5	66253057645	€00.00	+++
600x6,8x60	41	○	●	○		NZ24TBFX (Foundry X)	100	5	66253372435	€00.00	+++++
600x7x60	41		●	○		A24VBF (TOROS)	100	5	66253057646	€00.00	+++



NORTON

SAINT-GOBAIN®



SUPER ABRASIVES

Introduction	280	Diamond lapping compounds	303
DIAMOND & CBN GRINDING WHEELS	281-302	Diamond files	304
for Machining round tools	283	Diamond Dressers	305
for Round tool universal grinding	287		
for Sharpening saw blades	290		
for Sharpening HSS saw blades	294		
for General engineering	295		

INTRODUCTION

Diamond is the hardest material known to man, closely followed by Cubic Boron Nitride (CBN). As a result of their hardness these materials are used extensively in the most demanding precision grinding, slicing, and cutting applications. Super Abrasive wheels use diamond and CBN technology to cut demanding materials such as carbide, high speed steel, ceramics, and glass.

Norton provides ultimate, high performance Super Abrasive solutions for the cutting tools industry, offering products specifically designed to deal with the hardest and most challenging materials.

HOW TO READ A SPECIFICATION

ASD	151	R	75	B99
ABRASIVE TYPE	GRIT SIZE	GRADE	CONCENTRATION	BOND

ABRASIVE TYPE

Both diamond & CBN have distinctive characteristics that meet the most demanding applications.

ASD: Synthetic diamond, armoured, high quality, versatile.

CB: Cubic boron nitride, armoured, durable.

GRIT SIZE

Size of the Super Abrasive particles according to FEPA standards. The smaller the number, the finer the grit size.

GRADE

Refers to the degree of durability of the wheel, progressing alphabetically from A (softest, least durable) to Z (hardest, most durable).

CONCENTRATION

Indicates the amount of Super Abrasive grits in the wheel. For CBN wheels the concentration number is included in the grade (Q=50, T=75, W=100, Z=125), concentration 100~4,4 ct/cm³, & accordingly 50~2,2 ct/cm³. The optimum concentration depends upon the application.

BOND

The element in a grinding wheel that holds the diamond or CBN grains together.

GRIT SIZE

The grit size selection depends on the required stock removal rate and the required surface finish.

EUROPEAN (FEPA) SIZE	U.S. STANDARD	US NORTON GRIT SIZE [MESH]	
	MESH	DIAMOND	CBN
1182	16/20	16	-
852	20/30	24	24
602	30/40	36	36
501	35/40	-	-
427	40/50	46	46
301	50/60	60	60
251	60/70	-	-
-	50/80	80	80C
252	60/80	100	80
213	70/80	-	-
181	80/100	105	100
-	80/120	100S	120C
151	100/120	110	120
126	120/140	120	150
107	140/170	150	180
91	170/200	180	220
76	200/230	220	230
64	230/270	240	240
54	270/325	320	320
46	325/400	400	400

APPROXIMATE EUROPEAN (FEPA) SIZE	NOMINAL MICRON SIZE	NORTON GRIT SIZE [MESH]
M63	40/60	-
M40	30/40	500
M25	20/30	-
M16	10/20	600
M10	6/12	800
M6,3	4/8	-
M4,0	2/4	-
M1,0	0/2	-

CONCENTRATION

The concentration influences the stock removal rate and the geometry of the workpiece.

DIAMOND 50/75/100/125 **CBN** Q/T/W/Z

DIAMOND & CBN WHEELS

Norton diamond and CBN wheels are designed to grind and cut the hardest materials known to man, helping make 'difficult-to-grind' applications routine operations. Hardness, abrasion resistance, compressive strength, thermal conductivity are all features designed to achieve a high level of precision and quality, making them a logical choice for a wide range of applications.



DIAMOND WHEELS



BENEFITS

- High quality synthetic diamonds provide excellent material removal rate and longer wheel life than conventional silicon carbide wheels
- Engineered B-99 resin bond provides free cutting capabilities & superior form holding in dry tool room and 1A1R cut-off operations in grinding glass & ceramic materials
- Can be used wet or dry, in off-hand finishing of carbide tools, providing fast stock removal

APPLICATIONS

- Cemented carbide
- Glass
- Ceramics
- Fibreglass
- Plastics
- Stone
- Abrasives
- Electronic components and materials

CBN WHEELS



BENEFITS

- Made with durable CBN abrasive which cuts easily through hard to grind steels, HRC50 and harder, resisting wear
- Engineered B-99 resin bond for free cutting capability and superior form holding
- Aztec IV bond for larger cutting depth
- Used for dry tool resharpening when heavy stock removal is required

APPLICATIONS

- High speed tool steels
- Die steels
- Hardened carbon steels
- Alloy steels
- Aerospace alloys
- Hard stainless steel
- Abrasion-resistant ferrous materials

WHEEL SHAPES

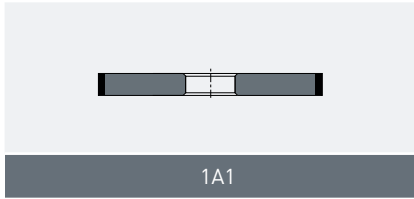

1A1

PAGE 272, 275, 284, 285

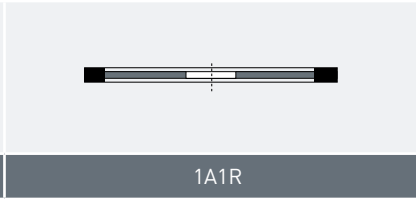

1A1R

PAGE 287

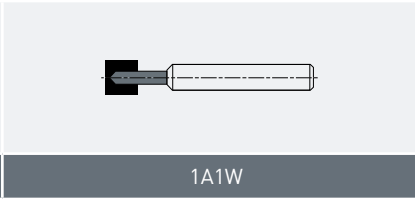

1A1W

PAGE 281, 286

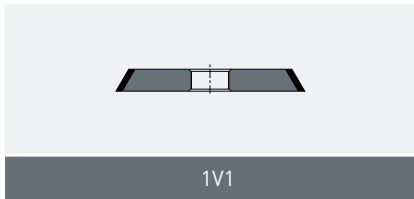

1V1

PAGE 272, 273

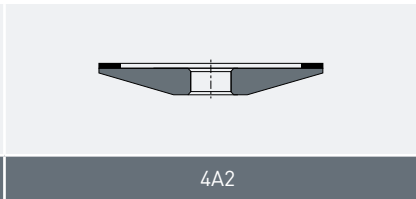

4A2

PAGE 279, 289

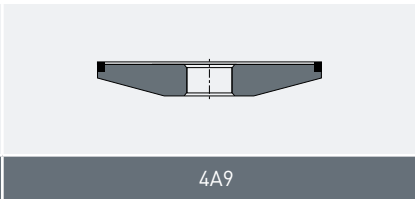

4A9

PAGE 281

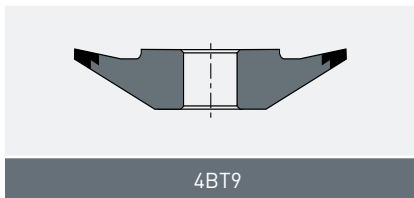

4BT9

PAGE 289

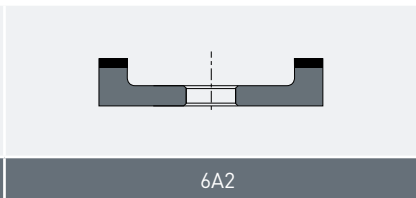

6A2

PAGE 275, 288

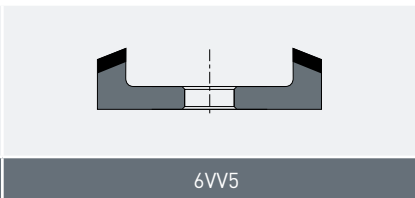

6VV5

PAGE 280

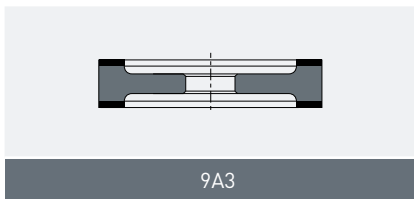

9A3

PAGE 276

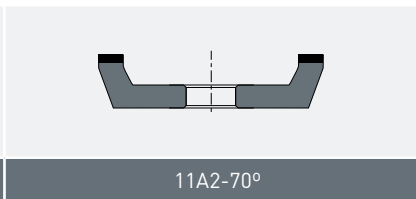

11A2-70°

PAGE 276

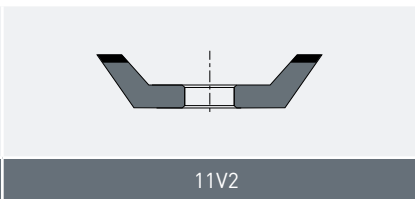

11V2

PAGE 276

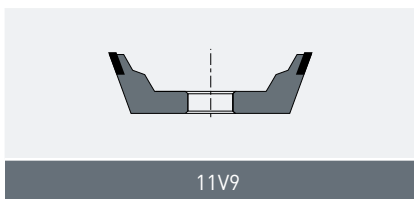

11V9

PAGE 274, 277

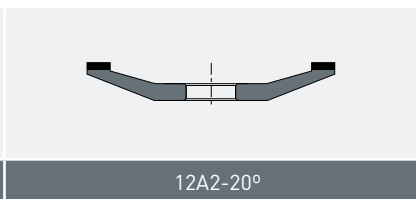

12A2-20°

PAGE 290

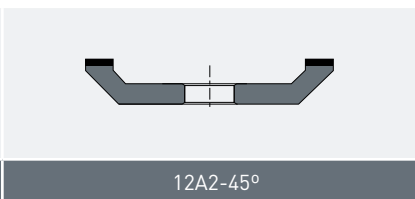

12A2-45°

PAGE 290

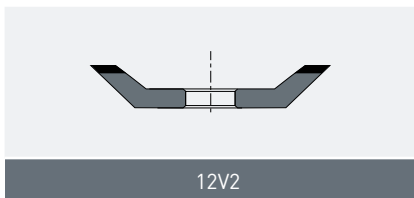

12V2

PAGE 279

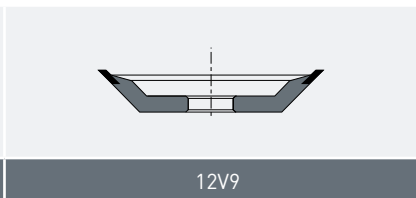

12V9

PAGE 273, 277, 279

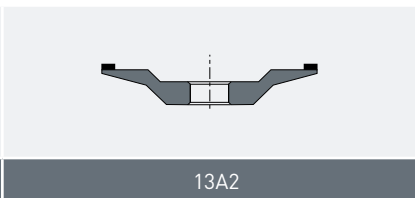

13A2

PAGE 290

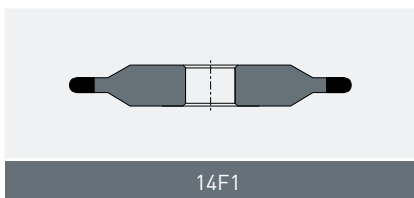

14F1

PAGE 282, 288

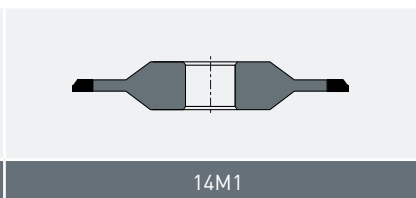

14M1

PAGE 280



ROUND TOOLS

DIAMOND AND CBN GRINDING WHEELS FOR THE MACHINING OF ROUND TOOLS

Norton offers a comprehensive product range for work on round tools including drills, end mills and reamers. Diamond and CBN grinding wheels are ideal for producing and re-sharpening tungsten carbide and HSS tools.

The following sections are arranged by application for easy identification of the correct grinding wheel for fluting, gashing, grinding of clearance angles and re-sharpening. Within the sub-chapters the grinding wheels are ordered by FEPA code.



BOND OVERVIEW DIAMOND

BOND	WEAR RESISTANCE	RECOMMENDATION FOR USE
R100 B99	↑	For CNC grinding operations (wet)
R75 B99		For universal grinding (wet or dry)
R50 B99		For universal grinding (wet or dry)
R75 B49		For universal grinding (dry)
R50 B49		For universal grinding (dry)

BOND OVERVIEW CBN

BOND	WEAR RESISTANCE	RECOMMENDATION FOR USE
W B99	↑	For CNC grinding operations (wet)
T B99		For universal grinding (wet or dry)
Aztec IV		Very free grinding dry grinding bond
R75 B49		For universal grinding (dry)



DIAMOND & CBN WHEELS FOR MACHINING ROUND TOOLS

The Norton B99 resin bonded wheel is ideal for flute grinding on CNC machines and is particularly suitable for applications on standard tools. D64R100B99 and B107 W B99 are the most commonly used products for flute grinding, however other specifications can be made available on request.



1A1 FLUTING

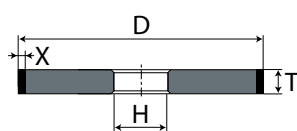

DxTxX (mm)	H (mm)	SPECIFICATION	PK QTY	ART NO.	PRICE
DIAMOND					
100x6x3	32	ASD91 R100 B99	1	7958732719	£000.00
100x10x5	20	ASD64 R100 B99	1	7958732706	£000.00
100x12x5	20	ASD64 R100 B99	1	7958732713	£000.00
125x5x3	20	ASD126 R100 B99	1	7958732469	£000.00
125x10x10	20	ASD64 R100 B99	1	7958732470	£000.00
125x12x10	20	ASD64 R100 B99	1	7958732471	£000.00
150x12x10	20	ASD64 R100 B99	1	7958732727	£000.00
CBN					
100x11x5	20	CB107 W B99	1	7958732712	£000.00
100x15x5	20	CB107 W B99	1	7958732716	£000.00
125x10x10	20	CB107 W B99	1	7958728828	£000.00

1V1 FLUTING

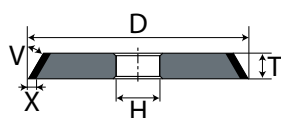

DxTxX (mm)	v (°)	H (mm)	SPECIFICATION	PK QTY	ART NO.	PRICE
DIAMOND						
100x10x5	10°	20	ASD64 R100 B99	1	7958732976	£000.00
100x15x5	20°	20	ASD64 R100 B99	1	7958732974**	£000.00
125x10x5	30°	20	ASD64 R100 B99	1	7958732984**	£000.00
CBN						
100x15x5	20°	20	CB107 W B99	1	7958732994	£000.00

** Available while stocks last



DIAMOND & CBN WHEELS FOR MACHINING ROUND TOOLS

The state-of-the-art Norton B99 resin bond is free cutting and has good corner stability, the most essential characteristic required for CNC gashing.

Two standard specifications are offered:

- For tungsten carbide tools: ASD64 R100 B99
- For HSS-tools: CB107 W B99.

Both are available in 12V9 as well as in 1V1 shape. Further combinations of dimensions, grit sizes and concentrations are available on request.



1V1 GASHING

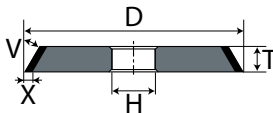

DxTxX (mm)	V (°)	H (mm)	SPECIFICATION	PK QTY	ART NO.	PRICE
DIAMOND						
100x15x5	45°	20	ASD64 R100 B99	1	7958732996*	£000.00
125x15x5	45°	45	ASD64 R100 B99	1	7958733015	£000.00
CBN						
100x15x5	45°	20	CB107 W B99	1	7958733013	£000.00
125x15x5	45°	20	CB107 W B99	1	7958733017	£000.00

* Made-to-order

12V9 GASHING

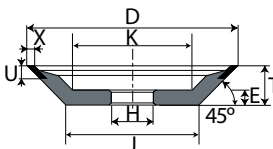

DxXxU (mm)	H (mm)	T (mm)	K (mm)	E (mm)	J (mm)	SPECIFICATION	PK QTY	ART NO.	PRICE
DIAMOND									
100x2x10	20	20	52	11	60	ASD64 R100 B99	1	7958732837	£000.00
100x3x10	20	20	52	11	60	ASD64 R100 B99	1	7958732832	£000.00
125x2x10	20	25	60	12	74	ASD64 R100 B99	1	7958733019	£000.00
150x3x10	20	25	81	15	99	ASD64 R100 B99	1	7958732919	£000.00
CBN									
100x3x10	20	20	52	11	60	CB107 W B99	1	7958732826	£000.00
125x3x10	20	25	71	14	74	CB107 W B99	1	7958732814	£000.00
150x3x10	20	25	81	15	99	CB107 W B99	1	7958732920	£000.00

ADDITIONAL INFORMATION
Stiffened body



DIAMOND & CBN WHEELS FOR MACHINING ROUND TOOLS

Norton B99 resin bond tools are an ideal choice for grinding clearances and relief angles on CNC machines. With excellent cutting behaviour the bond produces a good surface finish. The listed grinding wheels are suitable for the production and re-sharpening of tungsten carbide and HSS round tools.

D64 R100 B99 and B107 W B99 are the most common specifications for clearance angle grinding applications, however, other specifications are available on request.



11V9 CLEARANCE ANGLE GRINDING

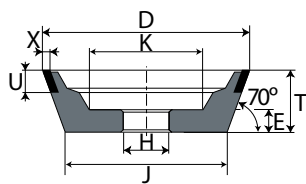

	DxXxU (mm)	H (mm)	T (mm)	K (mm)	E (mm)	J (mm)	SPECIFICATION	PK QTY	ART NO.	PRICE
DIAMOND										
	75x2x10	20	30	40	10	53	ASD64 R100 B99	1	7958732849	£000.00
	100x2x10	20	35	59	15	74	ASD64 R100 B99	1	7958732876	£000.00
	100x3x10	20	35	53	15	74	ASD64 R100 B99	1	7958732877	£000.00
	125x3x10	20	40	70	18	95	ASD64 R100 B99	1	7958732856	£000.00
CBN										
	75x2x10	20	30	40	10	53	CB107 W B99	1	7958732851	£000.00
	100x2x10	20	35	59	15	74	CB107 W B99	1	7958732874	£000.00
ADDITIONAL INFORMATION	100x3x10	20	35	53	15	74	CB107 W B99	1	7958732844	£000.00
Stiffened body	125x3x10	20	40	70	18	95	CB107 W B99	1	7958732854**	£000.00

** Available while stocks last



DIAMOND & CBN WHEELS FOR ROUND TOOL UNIVERSAL GRINDING

Norton offers a comprehensive selection of different bonds and concentrations for re-sharpening applications on universal machines. The B99 grinding wheels can be used wet or dry.

The lower the diamond or CBN concentration the more suited the product will be to grinding large contact areas. Aztec IV is a special free cutting resin bond which is designed for dry grinding operations and enables high material removal.

1A1 RE-SHARPENING

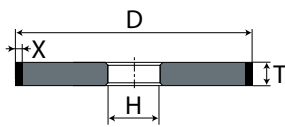

DxTxX (mm)	H (mm)	SPECIFICATION	PK QTY	ART NO.	PRICE
DIAMOND					
100x4x3	20	ASD91 R75 B99	1	7958732717	£000.00
100x10x5	20	ASD91 R75 B99	1	7958732711	£000.00
125x10x5	20	ASD126 R100 B99	1	7958732466	£000.00
150x10x3	20	ASD126 R50 B99	1	7958732724	£000.00
150x10x3	32	ASD126 R75 B99	1	7958732726	£000.00
CBN					
100x10x5	20	CB126 T B99	1	7958732704	£000.00
150x10x3	20	CB126 T B99	1	7958732725	£000.00

6A2 RE-SHARPENING

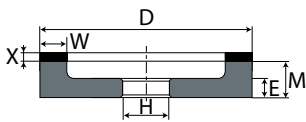

DxWxX (mm)	H (mm)	M (mm)	E (mm)	SPECIFICATION	PK QTY	ART NO.	PRICE
DIAMOND							
100x6x4	20	23	10	ASD151 R75 B99	1	7958732881	£000.00
100x12x2	20	18	10	ASD54 R50 B99	1	7958732886	£000.00
100x12x2	20	18	10	ASD107 R50 B99	1	7958732879	£000.00
125x6x5	20	25	10	ASD64 R75 B99	1	7958732922	£000.00
125x10x2	70	23	10	ASD107 R50 B99	1	7958732882	£000.00
150x10x2	20	23	10	ASD91 R50 B99	1	7958732932	£000.00
150x15x2	32	23	10	ASD107 R50 B99	1	7958732933	£000.00
150x20x2	20	20	10	ASD126 R75 B99	1	7958732934	£000.00
CBN							
125x6x4	20	23	10	CB151 T B99	1	7958732925	£000.00
150x6x4	20	23	10	CB151 T B99	1	7958732936	£000.00
150x6x4	32	23	10	CB151 T B99	1	7958732935	£000.00

DIAMOND & CNC WHEELS FOR ROUND TOOL UNIVERSAL GRINDING

9A3 RE-SHARPENING

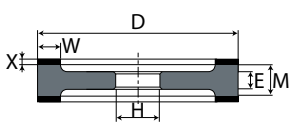

DxWxX (mm)	H (mm)	M (mm)	E (mm)	SPECIFICATION	PK QTY	ART NO.	PRICE
DIAMOND							
175x5x2	20	30	14	ASD126 R50 B99	1	7958733002	£000.00
175x5x2	20	30	14	ASD46 R50 B49	1	66260120338	£000.00
175x5x2	20	30	14	ASD64 R50 B49	1	66260120339	£000.00
175x5x2	20	30	14	ASD126 R50 B49	1	66260120340	£000.00

11A2-70° RE-SHARPENING

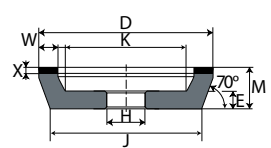

DxWxX (mm)	H (mm)	M (mm)	K (mm)	E (mm)	J (mm)	SPECIFICATION	PK QTY	ART NO.	PRICE
DIAMOND									
100x5x4	20	20	75	10	88	ASD151 R75 B99	1	60157682163	£000.00
CBN									
100x5x4	20	20	75	10	88	CB126 T B99	1	60157682165	£000.00

11V2 RE-SHARPENING

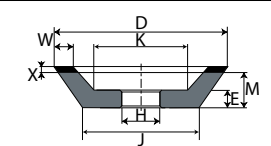

DxWxX (mm)	H (mm)	M (mm)	K (mm)	E (mm)	J (mm)	SPECIFICATION	PK QTY	ART NO.	PRICE
DIAMOND									
100x5x3	20	22	72	8	82	ASD91 R75 B99	1	7958733007	£000.00
100x5x3	20	22	72	8	82	ASD126 R75 B99	1	7958733011	£000.00

11V9 RE-SHARPENING

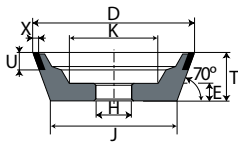

DxXxU (mm)	H (mm)	T (mm)	K (mm)	E (mm)	J (mm)	SPECIFICATION	PK QTY	ART NO.	PRICE
DIAMOND									
75x2x10	20	30	40	10	53	ASD107 R75 B99	1	7958732857	£000.00
75x2x10	20	30	40	10	53	ASD126 R75 B99	1	7958732859	£000.00
75x2x10	20	30	40	10	53	SD64 R75 B49	1	66260120321	£000.00
75x2x10	20	30	40	10	53	SD126 R75 B49	1	66260120322*	£000.00
100x2x10	20	35	55	10	74	ASD126 R75 B99	1	7958732867	£000.00
100x3x10	20	35	60	10	74	ASD126 R75 B99	1	7958732862	£000.00
100x3x10	32	35	60	10	74	ASD126 R75 B99	1	7958732865	£000.00
100x2x10	20	35	55	10	75	SD64 R75 B49	1	66260120323	£000.00
100x2x10	20	35	55	10	75	SD126 R75 B49	1	7958795053	£000.00
125x3x10	20	40	81	10	96	ASD126 R75 B99	1	7958732847	£000.00
125x3x10	32	40	81	10	96	ASD126 R75 B99	1	7958732848	£000.00
CBN									
75x1,5x10	20	30	40	10	53	BN181 Aztec IV	1	69014152323	£000.00
75x2x10	20	30	40	10	53	CB126 T B99	1	7958732853	£000.00
75x2x10	20	30	40	10	53	CB126 R75 B49	1	66260121233	£000.00
100x1,5x10	20	35	55	10	75	BN126 Aztec IV	1	69014152115	£000.00
100x1,5x10	20	35	55	10	75	BN181 Aztec IV	1	69014152118	£000.00
100x1,5x10	32	35	55	10	75	BN181 Aztec IV	1	69014152120	£000.00
100x2x10	20	35	55	10	74	CB126 T B99	1	7958732869	£000.00
100x2x10	32	35	55	10	74	CB126 T B99	1	7958732871*	£000.00
100x2x10	20	35	55	10	75	CB126 R75 B49	1	66260121234	£000.00

* Made-to-order

12V9 RE-SHARPENING

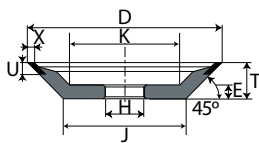

DxXxU (mm)	H (mm)	T (mm)	K (mm)	E (mm)	J (mm)	SPECIFICATION	PK QTY	ART NO.	PRICE
DIAMOND									
75x2x10	20	25	34	10	39	ASD64 R75 B99	1	7958732816	£000.00
75x3x6	20	20	45	10	42	ASD76 R75 B99	1	7958732890*	£000.00
75x2x10	20	20	45	10	35	SD15 R50 B49	1	66260120324	£000.00
75x2x10	20	20	45	10	35	SD64 R75 B49	1	66260120326	£000.00
75x2x10	20	20	45	10	35	SD126 R75 B49	1	66260120327	£000.00
100x2x6	20	20	64	10	59	ASD126 R75 B99	1	7958732821	£000.00
100x3x10	20	20	65	10	59	ASD46 R75 B99	1	7958732885	£000.00
100x2x10	20	20	65	10	60	SD15 R50 B49	1	66260120328*	£000.00
100x2x10	20	20	65	10	60	SD64 R75 B49	1	66260120329	£000.00
100x2x10	20	20	65	10	60	SD126 R75 B49	1	66260120330	£000.00
CBN									
75x2x6	20	20	45	10	42	CB107 T B99	1	7958732813	£000.00
75x2x10	20	20	45	10	35	CB126 R75 B49	1	66260121235	£000.00
100x2x6	20	20	65	10	59	CB126 T B99	1	7958732818	£000.00
100x3x10	20	20	65	10	59	CB126 T B99	1	7958732880	£000.00
100x2x10	20	20	65	10	60	CB126 R75 B49	1	66260121236	£000.00

* Made-to-order



SAW BLADES

DIAMOND AND CBN GRINDING WHEELS FOR THE SAW BLADE INDUSTRY

With an emphasis on excellent price vs. performance ratios, the saw blade programme aims to provide the best solutions for grinding tungsten carbide tipped saw blades and one-piece HSS saws.

The tungsten carbide tipped circular saw blade grinding wheels have been specifically designed for face grinding and flank grinding. Norton offers grinding wheels for the most common machine types required for these applications.

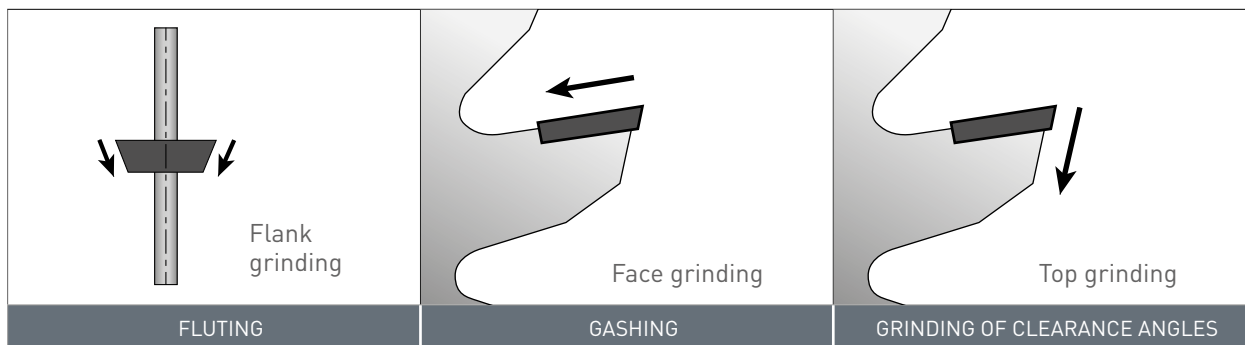

1A1W grinding pins for hollow tooth grinding are also available.

BOND OVERVIEW DIAMOND

BOND	WEAR RESISTANCE	RECOMMENDATION FOR USE
ECO Face	↑	Face grinding of tungsten carbide tipped saw blades
ECO Flank		Flank grinding of tungsten carbide tipped saw blades
ECO Top-AW		Top-grinding of tungsten carbide tipped saw blades on AKEMAT and WOODTRONIC machines
ECO Top		Universal top-grinding of tungsten carbide tipped saw blades
ECO Top-R		Top-grinding of tungsten carbide tipped saw blades, especially re-sharpening
ECO Top-P		Top-grinding of tungsten carbide tipped saw blades, especially production
B99		Universal resin bond for wet and dry grinding

BOND OVERVIEW CBN

BOND	WEAR RESISTANCE	RECOMMENDATION FOR USE
ECO Curve		Profiling and re-sharpening of HSS saw blades

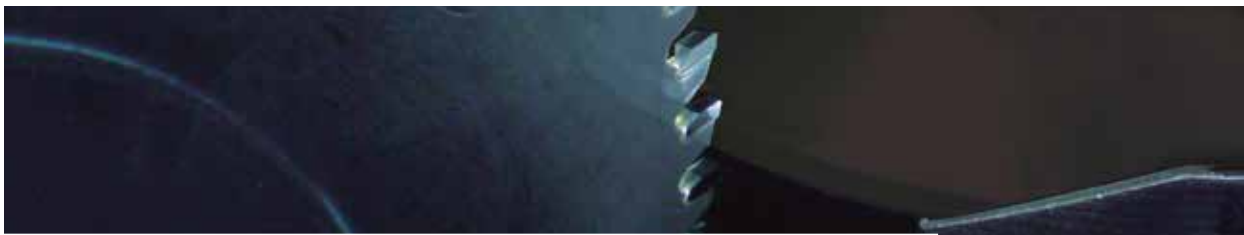

DIAMOND & CBN WHEELS FOR SHARPENING OF TUNGSTEN CARBIDE TIPPED SAW BLADES

The tooth face of circular saw blades is ground with sharp angled cup wheels. Depending on the tooth pitch, different angles and wheel thicknesses are required. The greater the number of teeth around the circumference, the narrower the space between them and the thinner the grinding wheel needs to be. Even the narrowest tooth gaps can be machined with our 12V9 ECO^{Face} wheels.

For reasons of stability, conventional tooth gaps are mainly ground using 4A2 or 12V2 grinding wheels.

4A2 FACE GRINDING

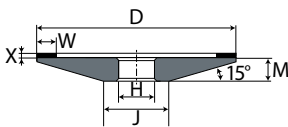

DxWxX (mm)	H (mm)	M (mm)	J (mm)	SPECIFICATION	PK QTY	ART NO.	PRICE
DIAMOND							
100x5x2	25*	7	51,5	ASD91 R75 B99	1	7958725784	£000.00

ADDITIONAL INFORMATION For conventional tooth gaps

*4A2K (with Keyway)

12V2 FACE GRINDING

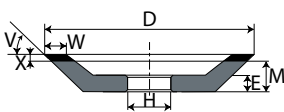

DxWxX (mm)	H (mm)	M (mm)	V (°)	E (mm)	SPECIFICATION	PK QTY	ART NO.	PRICE
DIAMOND								
125x4x2	32	11	30°	9	ASD46 R125 B99	1	60157682189	£000.00
125x4x2	32	11	30°	9	ASD76 R125 B99	1	60157682188	£000.00
200x4x2	32	13	30°	11	ASD46 R125 B99	1	7958725781	£000.00
200x4x2	32	13	30°	11	ASD76 R125 B99	1	7958725780	£000.00

ADDITIONAL INFORMATION For conventional tooth gaps

12V9 FACE GRINDING

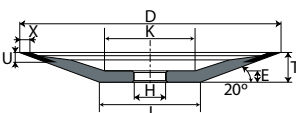

DxXxU (mm)	H (mm)	T (mm)	K (mm)	E (mm)	J (mm)	SPECIFICATION	PK QTY	ART NO.	PRICE
DIAMOND									
100x2,3x4	25*	10	77	7	51	D46 ECO Face	1	7958717431	£000.00
125x2,3x4	25*	10	101	7	76	D46 ECO Face	1	7958714565	£000.00
125x2,3x4	32	13	101	10	70	D46 ECO Face	1	69014148184	£000.00
150x2,3x4	32	13	126	10	95	D46 ECO Face	1	7958719191	£000.00
200x2,3x4	32	13	173	10	145	D46 ECO Face	1	69014148205	£000.00

ADDITIONAL INFORMATION
For conventional tooth gaps



DIAMOND & CBN WHEELS FOR SHARPENING OF TUNGSTEN CARBIDE TIPPED SAW BLADES

To ensure the circular nature of the saw and to define the wedge and clearance angles, the top of the saw blade needs to be ground.
Vollmer and Widma machines normally require 6VV5 cup wheels Akemat and Woodtronic machines require 14M1 state of the art peripheral wheels

6VV5 TOP GRINDING

	DxWxX (mm)	V (°)	H (mm)	T (mm)	E (mm)	SPECIFICATION	ADDITIONAL INFROMATION	PK QTY	ART NO.	PRICE
DIAMOND										
	100x5x10	8°	25*	24	7	ASD126/46 R100/ R75 ECO TOP	Universal use	1	7958725658	£000.00
	125x5x10	8°	32	22	11	ASD126/46 R100/ R75 ECO TOP-P	For production, oil	1	7958725661	£000.00
	125x5x10	8°	32	22	11	ASD126/46 R125/ R100 ECO TOP-R	For re-sharpening	1	7958725663	£000.00

*6VV5K (with keyway)

14M1 TOP GRINDING

	DxUxX (mm)	V (°)	H (mm)	T (mm)	J (mm)	SPECIFICATION	PK QTY	ART NO.	PRICE
DIAMOND									
	150x5x8	8°	32	10	119	ASD107/46 R100/ R75 ECO TOP-AW	1	7958725785	£000.00
	200x5x8	8°	32	10	156	ASD126/46 R100/ R75 ECO TOP-AW	1	7958725786	£000.00

ADDITIONAL INFORMATION D126/D46: U=2,5/2,5



DIAMOND & CBN WHEELS FOR SHARPENING OF TUNGSTEN CARBIDE TIPPED SAW BLADES

During the flank grinding process the cutting width of the circular saw blade is defined. Therefore, typically two 4A9 grinding wheels are simultaneously fed from both sides.

When manufacturing saw blades there is a wide variety of tooth geometries and designs to choose from. Depending on the intended use of the saw, the tooth design can be flat, alternate, trapezoid or any combination of these. Hollow ground teeth are very common to achieve finer cuts with no burrs. The rounded shape of hollow ground teeth is produced with 1A1W grinding pins.



4A9 FACE GRINDING

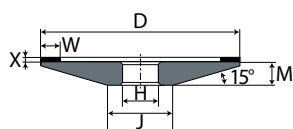

	DxXxW (mm)	H (mm)	T (mm)	J (mm)	SPECIFICATION	PK QTY	ART NO.	PRICE
	DIAMOND							
	80x4x5	32	10	53	ASD64 ECO Flank	1	7958725778	£000.00
	86x4x5	32	10	59	ASD64 ECO Flank	1	7958725779	£000.00
	100x4x4,5	20*	14	35	ASD64 ECO Flank	1	7958725739	£000.00
	100x4x4,5	20*	14	35	ASD126 ECO Flank	1	7958725744	£000.00
ADDITIONAL INFORMATION	100x4x5	32	10	55	ASD64 ECO Flank	1	7958725737	£000.00
Universal use	100x4x5	32	10	55	ASD126 ECO Flank	1	7958725738	£000.00

*4A9K (with Keyway)

1A1W HOLLOW TOOTH GRINDING

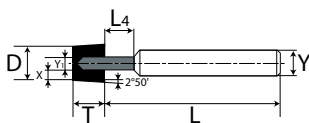

	DxTxX (mm)	Y (mm)	L (mm)	Y _i (mm)	L ₄ (mm)	SPECIFICATION	PK QTY	ART NO.	PRICE
	DIAMOND								
	6,5x3x1,75	6	42	4,1	10	ASD76 R125 B99	1	7958725782	£000.00
	7x3x2	6	42	5,1	10	ASD76 R125 B99	1	7958725783	£000.00
ADDITIONAL INFORMATION	For all common machines								

COLOUR CODES FOR MACHINE MANUFACTURERS

Vollmer-Biberach	Vollmer-Dornhan	Woodtronic	Akemat	Widma
------------------	-----------------	------------	--------	-------



DIAMOND & CBN WHEELS FOR SHARPENING HSS SAW BLADES

HSS saw blades are one-piece saws that are ground from one solid piece of metal. For this process HSS saws require special grinding machines.

14F1 wheels grind the required profile under CNC control. Wheels are ideal for both initial profiling and re-sharpening thanks to the advanced resin bond systems which ensure the wheels are economic and extremely wear resistant.

14F1 INITIAL PROFILING AND RE-SHARPENING

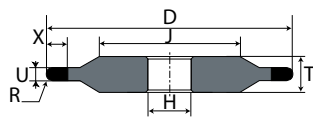

	DxUxX (mm)	R (mm)	H (mm)	T (mm)	J (mm)	SPECIFICATION	PK QTY	ART NO.	PRICE
	CBN								
	200x1,3x6,5	0,65	32	8	169	CB107 ECO Curve	1	7958706686	£000.00
	200x1,6x7	0,8	32	8	164	CB107 ECO Curve	1	7958714307	£000.00
	200x2x8	1	32	8	164	CB107 ECO Curve	1	7958706684	£000.00
	200x2,5x8	1,25	32	8	159	CB107 ECO Curve	1	7958716444	£000.00
ADDITIONAL INFORMATION	200x3x10	1,5	32	8	160	CB107 ECO Curve	1	7958718179	£000.00
For Loroch machines	200x4x12,5	2	32	8	157	CB107 ECO Curve	1	7958716216	£000.00



GENERAL ENGINEERING

DIAMOND AND CBN GRINDING WHEELS FOR GENERAL ENGINEERING

Norton diamond and CBN wheels for general engineering are suitable for many grinding applications like OD-, ID-, and flat grinding, machining of knives, milling cutters and polishing.

Most of the bonds listed in this section are made with ASD (armoured synthetic diamonds) grit and are suitable for wet and dry grinding applications. Some wheels use AMD (armoured metal bond diamonds) which are more wear resistant but require a coolant.

More information about the application can be found in the relevant sub-chapters.

BOND OVERVIEW DIAMOND

BOND	WEAR RESISTANCE	RECOMMENDATION FOR USE
R100 B99	↑	For universal grinding (wet or dry)
R75 B99		For universal grinding (wet or dry)
R50 B99		For universal grinding (wet or dry)
R75 B49		For universal grinding (dry)
R50 B49		For universal grinding (dry)

BOND OVERVIEW CBN

BOND	WEAR RESISTANCE	RECOMMENDATION FOR USE
W B99	↑	For universal grinding (wet or dry)
T B99		For universal grinding (wet or dry)
Q B99		For universal grinding (wet or dry)
R75 B49		For universal grinding (dry)
R50 B49		For universal grinding (dry)



DIAMOND & CBN WHEELS FOR GENERAL ENGINEERING

Norton offers a comprehensive stock programme for resin bonded 1A1 standard grinding wheels designed for OD- and flat grinding tungsten carbide and steel parts. All specified grinding wheels can be used for OD- and flat grinding. However wheels (R50) with lower concentration have been specifically designed for flat grinding operations. Other specifications are available on request.

1A1 OD AND FLAT GRINDING

	DxTxX (mm)	H (mm)	SPECIFICATION	PK QTY	ART NO.	PRICE
	DIAMOND					
	175x15x3	32	ASD126 R50 B99	1	7958732730	£000.00
	200x10x3	32	ASD126 R75 B99	1	7958732731	£000.00
	200x10x3	51	ASD126 R75 B99	1	7958732732	£000.00
	200x15x3	32	ASD126 R75 B99	1	7958732840	£000.00
	250x15x3	51	ASD126 R75 B99	1	7958764970**	£000.00
	250x15x3	76,2	ASD126 R75 B99	1	7958732804	£000.00
	300x10x3	127	ASD126 R75 B99	1	7958732824	£000.00
	300x15x3	76	ASD126 R75 B99	1	7958764968**	£000.00
	300x15x3	127	ASD126 R75 B99	1	7958732810	£000.00
	300x20x3	127	AMD126 R50 B99	1	7958732812	£000.00
	350x15x3	127	ASD126 R50 B99	1	7958788919*	£000.00
	350x20x3	127	ASD126 R50 B99	1	7958788920*	£000.00
	350x30x3	127	ASD126 R50 B99	1	7958788921*	£000.00
	400x15x3	127	ASD126 R50 B99	1	7958788923*	£000.00
	400x20x3	127	ASD126 R50 B99	1	7958788924*	£000.00
	400x30x3	127	ASD126 R50 B99	1	7958788925*	£000.00
	CBN					
	200x10x3	51	CB126 T B99	1	7958732803	£000.00
	200x15x3	32	CB126 Q B99	1	7958732838	£000.00
250x15x3	51	CB126 T B99	1	7958764971**	£000.00	
250x20x3	76,2	CB126 Q B99	1	7958732802	£000.00	
300x15x3	127	CB126 T B99	1	7958732808	£000.00	
300x20x3	127	CB126 Q B99	1	7958732815	£000.00	
350x15x3	127	CB126 Q B99	1	7958788927*	£000.00	
350x20x3	127	CB126 Q B99	1	7958788928*	£000.00	
350x30x3	127	CB126 Q B99	1	7958788929*	£000.00	
400x15x3	127	CB126 Q B99	1	7958788930*	£000.00	
400x20x3	127	CB126 Q B99	1	7958788932*	£000.00	
400x30x3	127	CB126 Q B99	1	7958788933*	£000.00	

* Made-to-order ** Available while stocks last

DIAMOND & CBN WHEELS FOR GENERAL ENGINEERING

Resin bonded grinding pins and grinding wheels can be used for wet or dry applications, either manually or on automatic grinding machines.

To avoid burning and to ensure stable grinding conditions the diameter must be carefully selected. It is highly recommended to choose a diameter no bigger than 70% of the bore. When using grinding pins it is very important to follow the permitted speed instructions, which are engraved on the grinding tool.

If the permitted speed is slower than the adjustable speed of the grinding spindle, a different technical solution is required.



1A1 ID GRINDING

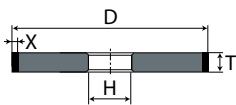

DxTxX (mm)	H (mm)	SPECIFICATION	PK QTY	ART NO.	PRICE
DIAMOND					
15x12x2	6	ASD126 R100 B99	1	7958732728	£000.00
20x10x2	6	ASD126 R100 B99	1	7958732950	£000.00
30x10x3	10	ASD126 R75 B99	1	7958732956	£000.00
40x15x3	10	ASD126 R75 B99	1	7958732971	£000.00
CBN					
12x10x2	6	CB126 W B99	1	7958732722	£000.00
15x12x2	6	CB126 W B99	1	7958732729	£000.00
20x10x2	6	CB126 W B99	1	7958732948	£000.00
20x15x2	6	CB126 W B99	1	7958732957	£000.00
25x10x2	10	CB126 W B99	1	7958732945	£000.00
25x12x2	10	CB126 W B99	1	7958732939	£000.00
30x15x3	10	CB126 W B99	1	7958732937	£000.00
40x15x3	10	CB126 W B99	1	7958732961	£000.00
50x15x3	20	CB126 W B99	1	7958732981	£000.00

DIAMOND & CBN WHEELS FOR GENERAL ENGINEERING

1A1W IDF GRINDING

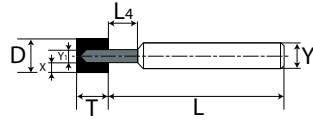

DxTxX (mm)	Y (mm)	L (mm)	Y ₁ (mm)	L ₄ (mm)	SPECIFICATION	PK QTY	ART NO.	PRICE
DIAMOND								
3x6x0,65	3	60	1,7	8	ASD64 R100 B99	1	7958732951	£000.00
3x6x0,65	3	60	1,7	8	ASD126 R100 B99	1	7958732949**	£000.00
5x6x1,5	3	60	2,1	8	ASD64 R100 B99	1	7958732944	£000.00
5x6x1,5	3	60	2,1	8	ASD126 R100 B99	1	7958732943	£000.00
6x6x1,5	6	60	3,1	8	ASD64 R100 B99	1	7958732940	£000.00
6x6x1,5	6	60	3,1	8	ASD126 R100 B99	1	7958732941	£000.00
8x10x2	6	60	4,1	12	ASD64 R100 B99	1	7958732954	£000.00
8x10x2	6	60	4,1	12	ASD126 R100 B99	1	7958732953	£000.00
10x10x2	6	60	-	-	ASD64 R100 B99	1	7958732959	£000.00
10x10x2	6	60	-	-	ASD126 R100 B99	1	7958732960	£000.00
12x12x2	6	60	-	-	ASD64 R100 B99	1	7958732963	£000.00
CBN								
3x6x0,65	3	60	1,7	8	CB126 W B99	1	7958732947	£000.00
5x6x1,5	3	60	2,1	8	CB126 W B99	1	7958732946	£000.00
6x6x1,5	6	60	3,1	8	CB126 W B99	1	7958732938	£000.00
8x10x2	6	60	4,1	12	CB126 W B99	1	7958732955	£000.00
10x10x2	6	60	-	-	CB126 W B99	1	7958732958	£000.00
12x12x2	6	60	-	-	CB126 W B99	1	7958732962	£000.00

** Available while stocks last



DIAMOND & CBN WHEELS FOR GENERAL ENGINEERING

Norton offers a small assortment of standard resin bonded cut-off grinding wheels. The specified diamond cut-off wheels cut hard, short-chipping and wear resistant materials such as glass, ceramics and carbide. The contained CBN cut-off wheels are ideal for machining high speed steel, hardened steel, 55 HRC and magnetic materials.

Further specifications for resin bond, sintered metal and electroplated metal bond are available on request.

1A1R CUT-OFF

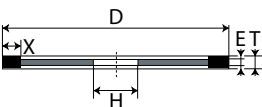
	DxTxX (mm)	E (mm)	H (mm)	SPECIFICATION	PK QTY	ART NO.	PRICE
	DIAMOND						
	100x0,9x5	0,7	20	ASD126 R75 B99	1	60157681683	£000.00
	125x1x5	0,7	20	ASD126 R75 B99	1	60157681686	£000.00
	150x1x5	0,8	20	ASD126 R75 B99	1	60157681688	£000.00
	CBN						
	100x0,9x5	0,7	20	CB151 T B99	1	60157681767	£000.00
	125x1x5	0,7	20	CB151 T B99	1	60157682094	£000.00
	150x1x5	0,8	20	CB151 T B99	1	60157682103	£000.00

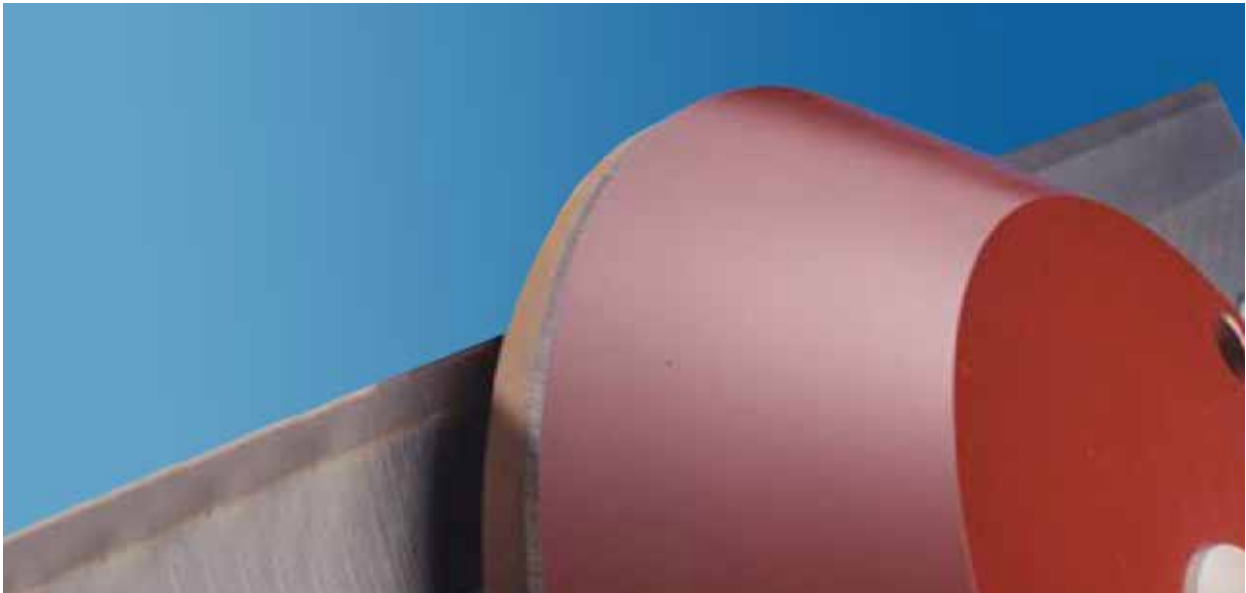

DIAMOND & CBN WHEELS FOR GENERAL ENGINEERING KNIFE GRINDING

Norton offers a range of resin bonded grinding wheels for machining flat, circular and profile knives.

The 6A2 grinding wheels are specifically designed for wet grinding of circular knives with tungsten carbide-steel combinations on Göckel and Reform machines.

The 14F1 grinding wheels are designed for use on Weing machines for grinding profile knives for the wood industry.

6A2 FLAT GRINDING

	DxWxX (mm)	H (mm)	M (mm)	E (mm)	SPECIFICATION	PK QTY	MACGINES	ART NO.	PRICE
	DIAMOND								
	200x8x4	50	31	23	AMD126 R100 B99	1	For Göckel	7958732926	£000.00
	200x8x4	75	31	23	AMD126 R100 B99	1	For Reform	7958732850	£000.00

14F1 PROFILE GRINDING

	DxUxX (mm)	R (mm)	H (mm)	T (mm)	J (mm)	SPECIFICATION	PK QTY	ART NO.	PRICE
	DIAMOND								
	200x2x7	1	60	10	129	ASD64 R100 B99	1	7958732992	£000.00
	200x4x7	2	60	10	134	ASD151 R100 B99	1	7958732986	£000.00
	CBN								
	200x2x7	1	60	10	129	CB126 T B99	1	7958732990	£000.00
For Weing machines	200x4x7	2	60	10	134	CB151 W B99	1	7958732988	£000.00

DIAMOND & CBN WHEELS FOR GENERAL ENGINEERING MILLING CUTTERS

Grinding tool faces and clearances are the main applications of the milling cutter.

Norton offers a diverse range of grinding wheels to enable excellent performance in both applications. A comprehensive range of grit sizes and concentrations provides the ideal solution for each application. The price vs. performance ratio of these tools is the underlying benefit of this product range.



4A2 FACE GRINDING

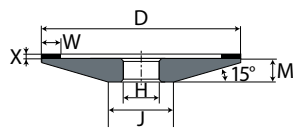

DxWxX (mm)	H (mm)	M (mm)	J (mm)	SPECIFICATION	PK QTY	ART NO.	PRICE
DIAMOND							
100x5x2	20	6	66	ASD64 R75 B99	1	7958732965	£000.00
125x5x2	20	7	84	ASD64 R75 B99	1	7958732868	£000.00
125x5x2	20	7	84	ASD126 R75 B99	1	7958732870	£000.00
125x5x2	32	7	84	ASD91 R75 B99	1	7958732866	£000.00
125x10x2	20	7	84	ASD107 R75 B99	1	7958732873	£000.00
150x5x2	32	9	94	ASD64 R75 B99	1	7958732863	£000.00
150x5x2	20	9	94	ASD126 R75 B99	1	7958732864	£000.00
150x5x2	32	9	94	ASD54 R50 B99	1	7958732858**	£000.00
150x5x2	32	9	94	ASD91 R75 B99	1	7958732855	£000.00
150x3x3,3	20	9	94	ASD64 R75 B49	1	66260120336*	£000.00
175x5x4	32	11	104	ASD126 R75 B99	1	7958732929*	£000.00
CBN							
100x5x2	20	6	66	CB126 T B99	1	7958732884	£000.00
150x5x4	20	9	94	CB107 T B99	1	7958732852	£000.00
150x3x3,3	20	9	94	CB107 R75 B49	1	66260120370*	£000.00
175x5x4	20	11	104	CB126 T B99	1	7958733000	£000.00

* Made-to-order ** Available while stocks last

4BT9 FACE GRINDING

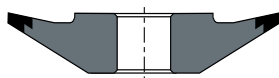

DxWxX (mm)	H (mm)	SPECIFICATION	PK QTY	ART NO.	PRICE
DIAMOND					
100x10x1	20	ASD64 R75 B99	1	66260171068*	£000.00
100x10x1	20	ASD126 R75 B99	1	66260171069*	£000.00
CBN					
100x10x1	20	CB64 T B99	1	66260171070*	£000.00
100x10x1	20	CB126 T B99	1	66260171067*	£000.00

* Made-to-order

DIAMOND & CBN WHEELS FOR GENERAL ENGINEERING

12A2-20° FACE GRINDING

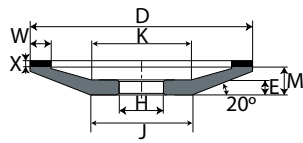

DxWxX (mm)	H (mm)	M (mm)	K (mm)	E (mm)	J (mm)	SPECIFICATION	PK QTY	ART NO.	PRICE
DIAMOND									
125x5x2	20	14	54	8	54	ASD126 R75 B99	1	69014151721	£000.00
125x6x4	20	14	54	8	54	ASD126 R100 B99	1	60157682171	£000.00
125x6x4	32	14	54	8	54	ASD91 R75 B99	1	60157682172	£000.00
150x5x2	20	16	68	9	68	ASD64 R50 B99	1	69014151397	£000.00
150x5x2	20	16	68	9	68	ASD126 R75 B99	1	69014151961	£000.00
150x5x2	32	16	68	9	68	ASD126 R75 B99	1	69014151963	£000.00
150x5x3	32	16	68	9	68	ASD64 R100 B99	1	60157682177	£000.00
150x5x3	32	16	68	9	68	ASD91 R100 B99	1	60157682176**	£000.00
175x5x2	20	18	82	10	82	ASD126 R75 B99	1	69014151422	£000.00
175x5x2	32	18	82	10	82	ASD126 R75 B99	1	69014151424	£000.00
CBN									
150x5x4	20	16	68	9	68	CB126 Q B99	1	69014151412	£000.00
150x6x4	32	16	68	9	68	CB126 T B99	1	60157682182	£000.00
175x5x4	20	18	82	10	82	CB126 T B99	1	69014151427	£000.00

** Available while stocks last

13A2 FACE GRINDING

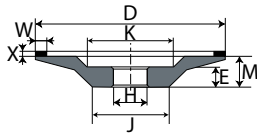

DxWxX (mm)	H (mm)	M (mm)	K (mm)	E (mm)	J (mm)	SPECIFICATION	PK QTY	ART NO.	PRICE
DIAMOND									
125x5x4	20	19	50	9	73	ASD126 R75 B99	1	7958732991**	£000.00
125x5x4	20	18	50	9	73	ASD64 R50 B49	1	66260120331	£000.00
125x5x4	20	18	50	9	73	ASD181 R50 B49	1	66260120332*	£000.00
150x5x4	20	20	75	11	95	ASD64 R50 B49	1	66260120333**	£000.00
CBN									
125x5x4	20	19	50	9	73	CB64 Q B99	1	7958732973	£000.00
125x5x4	20	18	50	9	73	CB64 R50 B49	1	66260120367**	£000.00
150x5x4	20	20	75	11	95	CB126 R50 B49	1	66260120368**	£000.00
175x5x4	20	22	75	11	95	CB126 R50 B49	1	66260120369**	£000.00

* Made-to-order ** Available while stocks last

12A2-45° TOP GRINDING

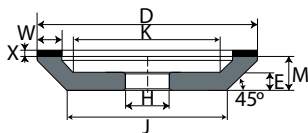

DxWxX (mm)	H (mm)	M (mm)	K (mm)	E (mm)	J (mm)	SPECIFICATION	PK QTY	ART NO.	PRICE
DIAMOND									
100x5x2	20	23	54	10	56	ASD107 R50 B99	1	7958732999	£000.00
100x6x3	20	20	64	10	62	ASD76 R75 B99	1	7958732968	£000.00
100x6x3	20	20	64	10	62	ASD126 R75 B99	1	7958732966	£000.00
125x6x3	32	23	83	10	81	ASD126 R75 B99	1	7958732969	£000.00
CBN									
100x5x2	20	23	54	10	56	CB126 Q B99	1	7958732997	£000.00
125x6x2	20	23	83	10	81	CB126 T B99	1	7958732970	£000.00



DIAMOND LAPPING COMPOUNDS FOR GENERAL ENGINEERING

Norton lapping compounds are supplied in a standard concentration of 5g dispenser syringes. Perfectly sized synthetic diamond powder is mixed with a paste. When used, this compound should be diluted with water or alcohol.

APPLICATIONS & MARKETS

- Used for lapping an extremely wide range of parts by hand
- Superfinishing of electronic components, semi-conductors, magnetic heads, rigid discs and optical discs
- Finishing for routine operations
- Preparatory lapping
- Fast removal of material, roughing

DIAMOND COMPOUND PASTE

- Optimised diamond grit distribution
- Easy and safe application

GRADE (MICRONS)	COLOUR	CONTENTS	PK QTY	ART. NO.	PRICE
1/4	GREY	5g	1	69014154990	£000.00
1/2	LIGHT GREY	5g	1	69014154991	£000.00
1	IVORY	5g	1	69014154992	£000.00
3	YELLOW	5g	1	69014154993	£000.00
6	ORANGE	5g	1	69014154994	£000.00
9	GREEN	5g	1	69014154995	£000.00
12	LIGHT BLUE	5g	1	69014154996	£000.00
15	BLUE	5g	1	69014154997	£000.00
20	BROWN	5g	1	69014154998	£000.00
30	RED	5g	1	69014154999	£000.00
45	CHESTNUT	5g	1	69014155000	£000.00
60	VIOLET	5g	1	69014155001	£000.00









DIAMOND FILES FOR GENERAL ENGINEERING

Norton offers a range of diamond files in various shapes for deburring, tool profiling, hardened steel & metal carbides, glass, ceramics & hard plastics.

FILES

- Free cutting and very high wear resistant, requiring only low contact pressure

SHAPE	T (mm)	H (mm)	L (mm)	PK QTY	ART. NO.	PRICE
	1,4	4,8	140	6	60157636812	£000.00
	1,9	5,3	140	6	60157636813	£000.00
	3,6	3,6	140	6	60157636814*	£000.00
	2,5	2,5	140	6	60157636815*	£000.00
	1,4	4,8	140	6	60157636817*	£000.00
Set - all above	-	-	-	6	60157636811*	£000.00



* Made-to-order



DIAMOND DRESSERS FOR CONVENTIONAL GRINDING WHEELS

Norton stationary diamond dressing tools have a worldwide reputation for quality and technology. Ideal for profiling and straight dressing of all conventional grinding wheels.

PRODUCT SELECTION GUIDE

APPLICATIONS	STRAIGHT PLUNGE GRINDING	ANGULAR PLUNGE / PROFILE GRINDING	CENTRELESS / THROUGH-FEED GRINDING	INTERNAL GRINDING	DIAFORM	SINTERED GRAINS
PROFILE AVAILABILITY						
Blade tool with CVD		●				●
Blade tool with natural grains	●	◐	●			◐
Profile dresser					●	
Multi point	◐		◐			
Single point				●		
					● Highly recommended	◐ Recommended

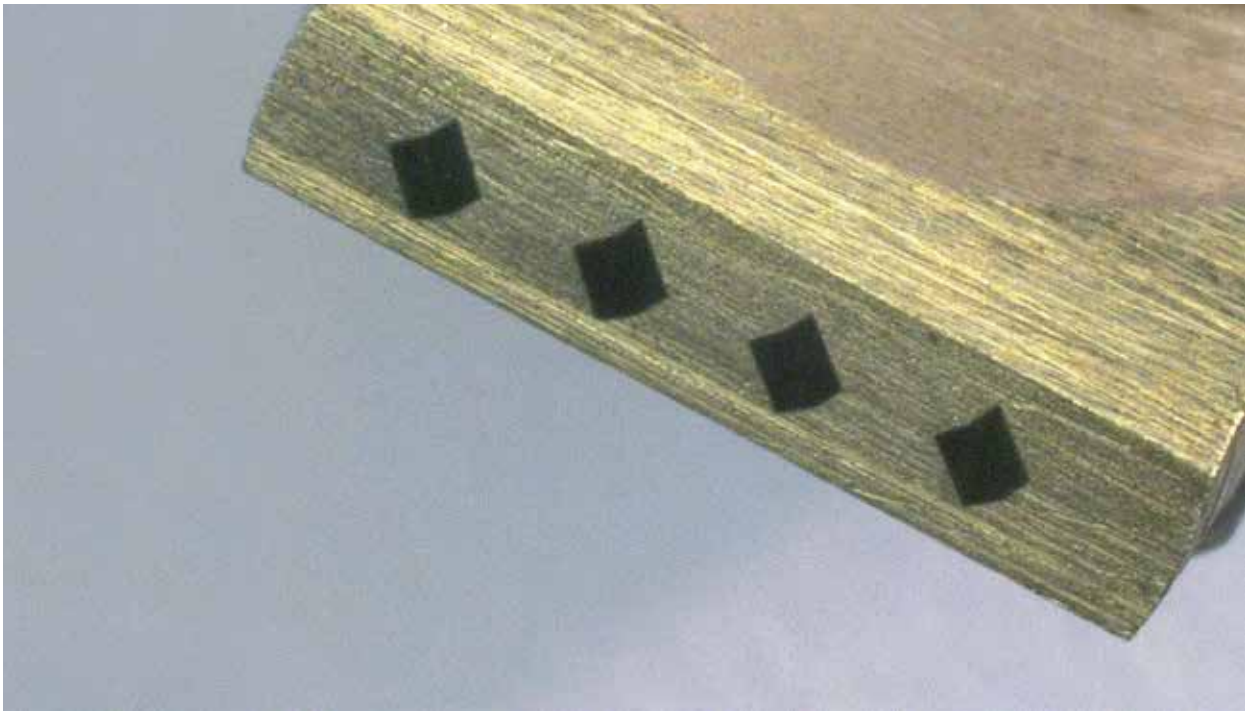

SELECTING A BLADE TOOL DRESSER

Dressing of profiles with blade tools	Dressing tools use a 'needle' form of natural or synthetic diamonds. Needle diamonds are especially suited to dressing profiles using infeeds and angular feeds.
Natural diamonds	An effective diamond layer with a length of up to 15mm creates an economical dressing solution. Using precise diamond setting patterns, with overlapped rows of stones, ensures that consistent dressing results are achieved.
Synthetic diamonds	The constant cross section given by synthetic diamonds, guarantees a constant dressing behaviour through the complete life of the dressing tool.

SELECTION OF GRIT SIZE

Grit size of grinding wheel	Synthetic diamond size (mm)	Natural diamond size
46	0,8x0,8	D1181
60	0,8x0,8	D1001
80-120	0,6x0,6	D711



A new dressing tool should be put through at least 5 dressing cycles in order to fit the diameter of the grinding wheel.
The lifetime of the dressing tool is extended by ensuring that adequate coolant pressure and volume are directed at the tool.

SELECTION OF TOOL SIZE

	Diameter x Thickness (mm)	No. of synthetic needles	Dimensions (mm)
	<35000	2	10,5x28
	35000-60000	3	20,5x28
	60000-100000	4	20,5x28

NUMBER OF CVD NEEDLES PER BLADE

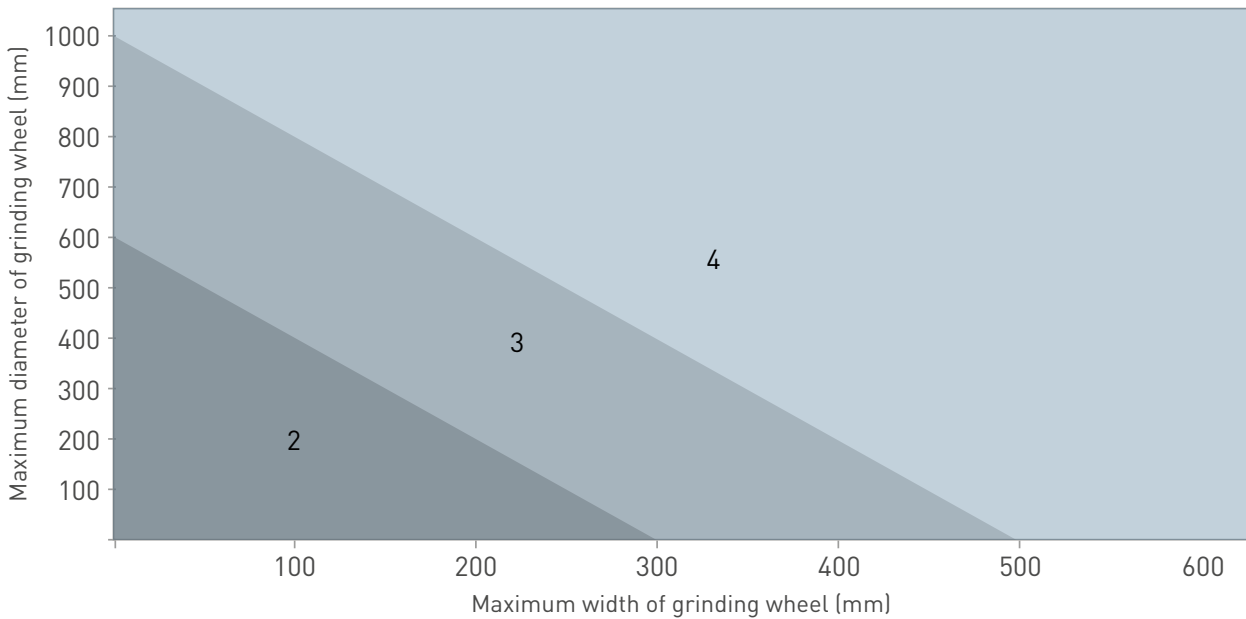

SELECTING A SINGLE-POINT DRESSER

Which tool to choose depends mainly on the dimensions of the wheel to be dressed. In order to calculate this, it is best to use the following method:

MULTIPLY THE DIAMETER OF THE WHEEL BY ITS THICKNESS

	Diameter x Thickness (mm)	Carat
	< 6000	0,33 Carat
	6000 – 18000	0,50 Carat
	> 18000	1,0 Carat

For best results, always use a coolant when dressing

SELECTING A MULTI-POINT DRESSER

Which tool to choose depends mainly on the dimensions of the wheel to be dressed. In order to calculate this, it is best to use the following method:

MULTIPLY THE DIAMETER OF THE WHEEL BY ITS THICKNESS

	Diameter x Thickness (mm)	Carat
	< 30000	1,3 Carat
	30000 – 60000	2,5 Carat
	> 60000	5,0 Carat

For best results, always use a coolant when dressing

DIAMOND DRESSERS

CHOICE OF DIAMOND GRIT

Wheel abrasive	Diamond
80-120	D301
60-80	D711
46-60	D1001
36-46	D2240

BLADE TOOL DRESSERS HPB-D 3565 & 3585



- Synthetic multi-crystalline diamond
- The most consistent dresser for demanding profiling and straight dressing

WxLxDL (mm)	GRIT	SPECIFICATION	PK QTY	ART NO.	PRICE
10,5x28x4	0,6x0,6	HPB-D 3565 / 2	1	60157682820	£0.00
10,5x28x4	0,6x0,6	HPB-D 3565 / 3	1	60157682856	£0.00
10,5x28x4	0,6x0,6	HPB-D 3565 / 4	1	60157682895	£0.00
10,5x28x4	0,8x0,8	HPB-D 3585 / 2	1	60157682899	£0.00
10,5x28x4	0,8x0,8	HPB-D 3585 / 3	1	60157682902	£0.00
10,5x28x4	0,8x0,8	HPB-D 3585 / 4	1	60157682904	£0.00



BLADE TOOL DRESSERS HPB-D & -C 30, 45, 60



- An economical dressing solution for all Alox and SiC wheels.
- Natural diamond
- Needles are recommended for profile dressing

WxLxDL (mm)	GRIT	SPECIFICATION	PK QTY	ART NO.	PRICE
10,5x28x12	D711	HPB-D 30	1	60157682759*	£0.00
10,5x28x12	D1001	HPB-D 45	1	60157682782	£0.00
10,5x28x12	D1181	HPB-D 60	1	60157682786	£0.00
10,5x28x12	NEEDLE	HPB-D	1	60157682790	£0.00
20,5x28x10	D711	HPB-C 30	1	60157682801	£0.00
20,5x28x10	D1001	HPB-C 45	1	60157682806	£0.00
20,5x28x10	D1181	HPB-C 60	1	60157682809	£0.00
20,5x28x10	NEEDLE	HPB-C	1	60157682814	£0.00



* Made-to-order

SCREWED SHANKS FOR BLADE TOOL DRESSERS



DIA (mm)	L (mm)	SHANK CODE	SPECIFICATION	PK QTY	ART NO.	PRICE
12,065	40	MT1	HPB-H3	1	60157682832	£0.00
9,045	25,5	MT0	HPB-H4	1	60157682907	£0.00
11,11	50	Z11,11	HPB-H2	1	60157682910	£0.00
10,00	50	Z10	HPB-HX	1	60157682911	£0.00

SINGLE-POINT DRESSER BC SG **+++++**

- Highest quality diamonds
- Specifically developed for dressing ceramic abrasive (SG/TG) wheels which require faster traverse speed dressing
- High performance tools
- Enables dressing costs to be reduced, specially at production grinding stations

SHANK (mm)	CARAT	PK QTY	ART NO.	PRICE
Z8	0,50	1	66260161757	£000.00
	1,00	1	66260161755	£000.00
Z10	0,33	1	66260161769	£000.00
	0,50	1	66260161768	£000.00
	1,00	1	66260161766	£000.00
Z11,11	0,33	1	66260156906	£000.00
	0,50	1	66260156907	£000.00
	1,00	1	66260157010	£000.00
Z12	0,50	1	66260161779	£000.00
	1,00	1	66260161777	£000.00



SINGLE-POINT DRESSER BC (CYLINDRICAL SHANK) **+++++**

- Standard diamonds
- Ideal for applications where it is difficult to measure the performance of the dressing tool
- Economy product
- Suitable for dressing conventional abrasive wheels

SHANK (mm)	CARAT	PK QTY	ART NO.	PRICE
Z8	0,33	1	66260161753	£0.00
	0,50	1	66260161752	£0.00
	1,00	1	66260161750	£0.00
Z10	0,33	1	66260161764	£0.00
	0,50	1	66260161763	£0.00
	1,00	1	66260161761	£0.00
Z11,11	0,33	1	66260195003	£0.00
	0,50	1	66260195005	£0.00
	1,00	1	66260195009	£0.00
Z12	0,33	1	66260161775	£0.00
	0,50	1	66260161774	£0.00



DIAMOND DRESSERS

SINGLE-POINT DRESSER SP (MK- SHANK) **+++**

- Commercial standard diamonds
- Standard dresser for conventional abrasive wheels

SHANK (mm)	CARAT	PK QTY	ART NO.	PRICE
MK0	0,3	1	69014119596	£000.00
	0,5	1	69014119598	£000.00
	1,0	1	69014119599	£000.00
	1,5	1	69014119600	£000.00
MK1	0,3	1	69014119570	£000.00
	0,5	1	69014119591	£000.00
	1,0	1	69014119594	£000.00
	1,5	1	69014119595	£000.00



PROFILE DRESSER **+++++**

- Extremely high performance tools
- Used to meet extremely high profile accuracy requirements

SHANK (mm)	RADIUS (mm)	ANGLE	SPECIFICATION	ART NO.	PRICE
Z9,52	0,13	40°	DC 40/130	60157682850	£000.00
	0,25	40°	DC 40/250	60157682889	£000.00
	0,50	40°	DC 40/500	60157682901	£000.00
	0,13	60°	DC 60/130	60157682903	£000.00
	0,25	60°	DC 60/250	60157682905	£000.00
	0,50	60°	DC 60/500	60157682909	£000.00

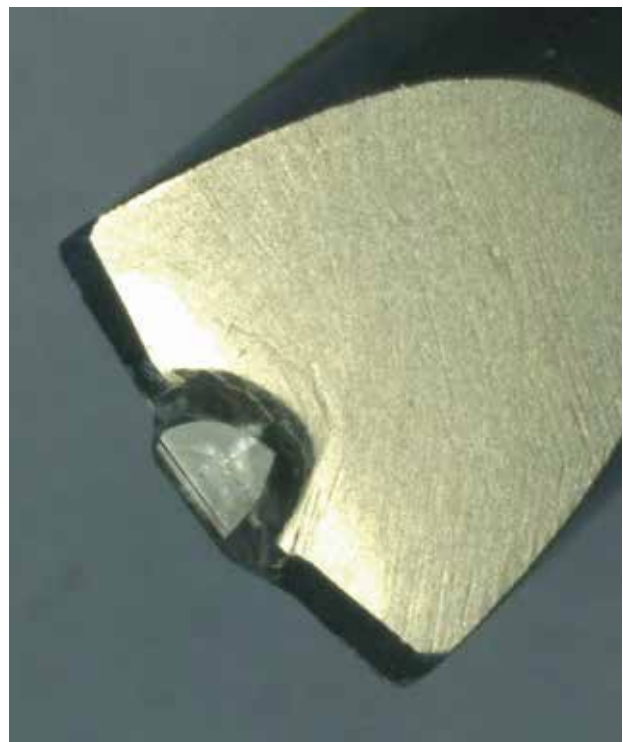
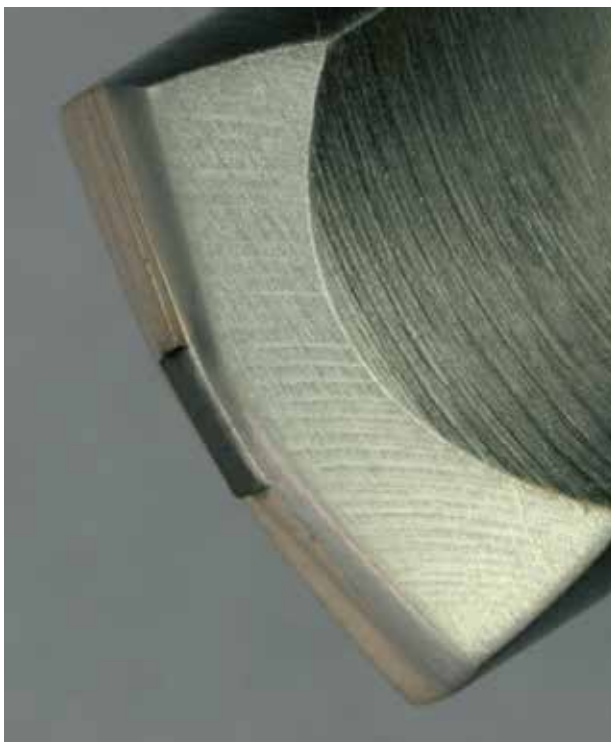

MULTI-POINT DRESSER **+++++**

- Economical and robust too
- Ideal for straight dressing at high speed with low technical demands

TYPE	SHANK (mm)	GRIT	PK QTY	ART. NO.	PRICE
D11x11 (5 Carat)	Z8	D2240	1	60157682849	£000.00
		D1001	1	60157682896	£000.00
		D711	1	60157682906	£000.00
	Z10	D2240	1	60157682892	£000.00
		D1001	1	60157682897	£000.00
		D711	1	60157682908	£000.00
	Z11,11	D2240	1	60157682893	£000.00
		D1001	1	60157682898	£000.00
		D711	1	60157682912	£000.00
MT1 12,065	D2240	1	60157682894	£000.00	
	D1001	1	60157682900	£000.00	
	D711	1	60157682914	£000.00	
D8x11 (2,5 Carat)	Z8	D2240	1	60157682915	£000.00
		D1001	1	60157682920	£000.00
		D711	1	60157682970	£000.00
	Z10	D2240	1	60157682916	£000.00
		D1001	1	60157682922	£000.00
		D711	1	60157682968	£000.00
	Z11,11	D2240	1	60157682917	£000.00
		D1001	1	60157682923	£000.00
		D711	1	60157682977	£000.00
	MT1 12,065	D2240	1	60157682918	£000.00
		D1001	1	60157682925	£000.00
		D711	1	60157682981	£000.00
D6x8 (1,3 Carat)	Z8	D711	1	60157682986	£000.00
		D301	1	60157683153	£000.00
	Z10	D711	1	60157682990	£000.00
		D301	1	60157683154	£000.00
	Z11,11	D711	1	60157682992	£000.00
		D301	1	60157683155	£000.00
	MT1 12,065	D711	1	60157682996	£000.00
		D301	1	60157683156	£000.00



DIAMOND DRESSERS

HAND DRESSER **+++++**

- High diamond concentration
- Grit 18/25 SPC
- High wear resistance and long product life time
- Suitable for face and side dressing



SPECIFICATION	PK QTY	ART NO.	PRICE
HD-150	1	60157682852	£000.00

BRAKE CONTROLLED TRUING DEVICE **+++++**

- For fast effective truing of diamond and CBN wheels with minimum loss of abrasive
- Ideal for truing diamond and CBN wheel types: straight wheels with diamond in the periphery, tool and cutter grinding wheels, wheels used on surface and cylindrical grinding machines, cut-off wheels and internal grinding wheels and cup wheels with diamonds in the rim, as used on vertical spindle surface grinders



SPECIFICATION	PK QTY	ART NO.	PRICE
BCTD	1	66260274459	£000.00

SCREWED SHANKS FOR BLADE TOOL DRESSERS **+++++**

DIA (mm)	T (mm)	B (mm)	SPECIFICATION	PK QTY	ART NO.	PRICE
80	25	13	Wheel 37C60-NV	10	69936668764	£0.00

DRESSING STICKS **+++**

- High purity white aluminium oxide abrasive
- Friable abrasive
- Ideal for dressing CBN Super Abrasive wheels

DIA (mm)	SPECIFICATION	PK QTY	ART NO.	PRICE	APPLICATION
	38A 150 HVBE	10	61463605565	£000.00	For SA wheels ≥D54
13x25x150	38A 220 HVBE	10	61463605066	£000.00	-
	38A 320 HVBE	10	69936684889	£000.00	For SA wheels ≤D46



Mount the device spindle parallel to the wheel spindle to ensure correct straight face truing
For cup shaped wheels, the device spindle will be mounted perpendicularly to the wheel spindle
Use appropriate traverse rates.

TECHNICAL INFORMATION

DESIGNATION OF GRIT SIZES

FEPA MICRONS	US MESH	JIS	DWMI	DIAMOND	CBN	RA (mm) SURFACE FINISH		
						CARBIDE	STEEL PLUNGE	STEEL OSCILLATING
1181	16/18							
1182	16/20			16				
1001	18/20							
851	20/25							
852	20/30	20		24	24			
711	25/30							
601	30/35							
602	30/40	30		36	36			
501	35/40							
426	40/45							
427	40/50	40		46	46			
356	45/50							
301	50/60	50		50	50			
	50/80							
251	60/70			60	60			
252	60/80	60	60	80c	80c	0,6-0,9		
213	70/80			80	80			
181	80/100	80	80	100	100	0,4-0,7	1,0-1,1	0,9-1,1
	80/120			110c				
151	100/120	100	100	110	120		0,9-1,0	0,8-0,9
126	120/140	120	120	120	150	0,4-0,5	0,8-0,9	0,6-0,8
107	140/170	140	150	150	180		0,6-0,8	0,5-0,6
91	170/200	170	180	180	220	0,3-0,4	0,5-0,6	0,4-0,5
76	200/230	200	220	220	230			
64	230/270	230	240	240	240	0,2-0,3	0,4-0,5	
54	270/325	270	320	320	320			
46	325/400	325	400	400	400	0,1-0,2		
	400/500	400		500	500			
M63	40/60							
M40	30/40	500		500				
M25	20/30	700						
	15/25	800						
M16	*10/20*	1000		600				
	8/16	1500						
M10	*6/12*	2000		800				
M6,3	*4/8*	2500						
	3/6	4000						
M4	*2/4*	5000						
M1	*0/2*	15000						

CONCENTRATION

The concentration is defined by a standard and indicates the weight of abrasive (in carats) contained in 1cm³ of abrasive strip – 1 carat = 0,2 grams.

CONCENTRATION*			NUMBER OF CARATS/cm ³	=	ABRASIVE WEIGHT PER cm ³
DIAMOND ABRASIVE	=	CBN ABRASIVE*			
100	=	W	4,4	=	0,88g/cm ³
75	=	T	3,3	=	0,66g/cm ³
50	=	Q	2,2	=	0,44g/cm ³

* Other concentrations available upon request

SELECTION OF CONCENTRATION

The choice of concentration depends on the machining parameters:

HIGH CONCENTRATION			MEDIUM OR LOW CONCENTRATION	
Roughing operations			Finishing operation	
Powerful machine			Low power machine	
Small contact area			Large contact area	
Retention of profile or sharp edges of wheel			Cutting without temperature rise	
OPERATION	INTERNAL GRINDING	EXTERNAL GRINDING	SURFACE GRINDING	SHARPENING
Diamond	100	75	50	50/75
CBN	W	T	Q	Q/T



NORTON

SAINT-GOBAIN®

DIAMOND TOOLS

Introduction	316	CUP GRINDERS	330-332
DIAMOND BLADES	317-329	for Concrete & Building Materials	330
for Concrete & Reinforced Concrete	317	DRILLING CORE BITS	333-338
for Universal Building Materials	318	for Concrete	333
for Multi Materials	323	for Universal Building Materials	336
for Ceramic & Porcelain Tiles	326	Technical Information	338
for Asphalt & Abrasive Materials	329		

INTRODUCTION

Norton Clipper Diamond Blades are the ultimate abrasive cutting solution in construction and building industries. With a range of products suitable for use on concrete, tile, brick, and asphalt, Norton Clipper offers the best choice for every cutting and drilling application in the building/construction industry.

UNDERSTANDING THE PRODUCT

- 1 Safety pictograms
- 2 Strong Norton Clipper branding
- 3 Product name
- 4 Product dimensions (mm)
- 5 Machine type
- 6 oSa certified
The Organisation for Safety of Abrasives
- 7 European safety standard EN13236:2010



DIFFERENTIATION IN THE RANGE

Norton offers the industry's widest selection of diamond blades to meet every customer requirement. The range is classified into three quality-tiers (best/better/good) to help you choose the right product for your specific application.



The Norton Clipper Extreme product range offers high performance; fast cutting and long blade life, for heavy usage, to meet the need of the most demanding applications.



Norton Clipper Pro is a professional quality range designed for frequent use. The Pro range offers great performance in speed of cut and blade life.



Norton Clipper Classic is a range of standard diamond tools for low frequency use, providing a good quality to performance ratio.

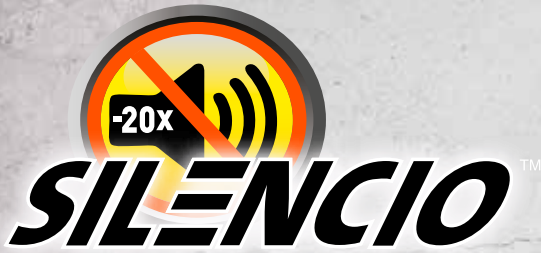

++++ INNOVATION

A PREMIUM CUTTING
SILENT DIAMOND BLADE



DIAMOND BLADES FOR CONCRETE & REINFORCED CONCRETE

Reinforced concrete, cured concrete, kerb stones, concrete pipes, engineering bricks, facing bricks, refractory bricks, flagstones and paving stones, block paving, washed gravel concrete slabs, natural stone, flint, sandstone, limestone.

EXTREME BETON SILENCIO

Residential areas, city centres, schools and hospitals are especially sensitive to noise, with local regulations preventing excessive noise levels. With up to 17mm high segments and a bespoke specification for each application, Norton Silencio is our quietest diamond blade, reducing noise by up to 20x (-13 dB) compared to conventional blades when used on concrete, reinforced concrete, granite and building materials, while achieving a fast, efficient cut.

- A noise dampening layer is sandwiched between two sheets of steel which absorbs the cutting vibrations and sound of the product when in use
- Patented 'off-set gullets' prevent whistling air flow around the diamond blade
- Each blade is fine-tuned to provide the best possible noise reduction and cutting performance on a particular machine application.



+LASER

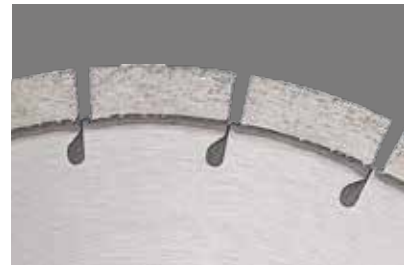

MACHINES	DIA (mm)	BORE (mm)	SEGMENT H/W (mm)	PK QTY	ART NO.	PRICE
	230	22,23	17/2,8	1	70184601168	£000.00
	300	20	15/3,2	1	70184629000	£000.00
	300	25,4	15/3,2	1	70184642421	£000.00
	350	25,4	15/3,2	1	70184628999	£000.00
	350	25,4	15/3,2	1	70184628997	£000.00
	450	25,4	15/3,2	1	70184631020	£000.00
	500	25,4	15/3,2	1	70184630416	£000.00





DIAMOND BLADES FOR UNIVERSAL BUILDING MATERIALS

Cured concrete, kerbs, concrete pipes, bricks, block paving, flagstones and paving stones, washed gravel concrete slabs, natural stone, sandstone, limestone, flint.

PRODUCT SELECTION GUIDE

Highly Recommended ●
Recommended ◐



MATERIALS	EXTREME UNIVERSAL SILENCIO	EXTREME UNIVERSAL TURBO	EXTREME UNIVERSAL LASER	PRO UNIVERSAL TURBO	PRO UNIVERSAL TP	PRO UNIVERSAL LASER	CLASSIC UNIVERSAL TURBO	CLASSIC UNIVERSAL LASER	CLASSIC UNIVERSAL
	+++++	+++++	+++++	++++	++++	++++	+++	+++	+++
Steel									
Granite	●	●	◐						
Engineering bricks	●	●	◐	●		◐			
Cured concrete	●	●	●	◐		●	◐	●	◐
Clay/pipes/paviors	●	●	◐	●					
Quarry tiles		◐	◐						
Marble	◐	●	◐	●					
Hard paviors	●	●	◐	●		●	◐	●	◐
Clay roof tiles	◐	●	◐	●		◐	◐	◐	◐
Terrazo		◐	◐						
Facing bricks	●	●	●	●		●	◐	◐	◐
Reinforced concrete	●	◐	●	◐		●	◐	●	◐
Concrete paving slabs	●	●	◐	◐		●	◐	●	◐
Concrete pipes/kerbs	●	●	●	●		●	◐	●	◐
Slate		●	●	●					
Limestone concrete	●	◐	●	◐		●	◐	◐	◐
Medium block paviors	●	●	●	◐		●	◐	●	◐
Concrete roof tiles	◐	●	●	●		●	◐	●	◐
Sandstone	●		◐						
Asphalt over concrete									
Breeze blocks						●			
Tarmac top blocks									
Mortar jointing					●				
Asphalt									

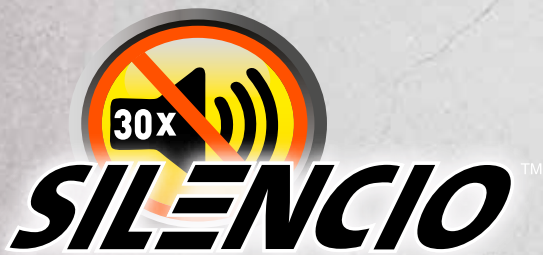

++++ INNOVATION

**A PREMIUM CUTTING
SILENT DIAMOND BLADE**



EXTREME UNIVERSAL SILENCIO

Residential areas, city centres, schools and hospitals are especially sensitive to noise, with local regulations preventing excessive noise levels. With up to 15mm high segments and a bespoke specification for each application, Norton Silencio is our quietest diamond blade, reducing noise by up to 30x (-15 dB) compared to conventional blades when used on concrete, granite and building materials, while achieving a fast, efficient cut.

- A noise dampening layer is sandwiched between two sheets of steel which absorbs the cutting vibrations and sound of the product when in use
- Patented 'off-set gullets' prevent whistling air flow around the diamond blade
- Each blade is fine-tuned to provide the best possible noise reduction and cutting performance on a particular machine application.



***LASER**



MACHINES	DIA (mm)	BORE (mm)	SEGMENT H/W (mm)	PK QTY	ART NO.	PRICE
	300	25,4	15/2,8	1	70184640269	£000.00
	350	25,4	15/2,8	1	70184628998	£000.00
	400	25,4	15/3,1	1	70184640270	£000.00
	500	25,4	15/3,2	1	70184630309	£000.00



**WATCH THE
NORTON
SILENCIO BS
IN ACTION!**

DIAMOND BLADES FOR UNIVERSAL BUILDING MATERIALS

EXTREME UNIVERSAL TURBO **+++++**

- 12mm impregnated diamond segments provide very long life
- Arrow shaped inserts on the blade protect the steel core for reduced blade wear, as well as indicating the correct direction for rotation.
- The ventilated waved steel centre reduces heat which aids blade rigidity during dry cutting
- The corrugated continuous rim enables smooth, high quality cutting and ease of use. It also cuts more aggressively on hard materials.
- Ideal for use on a very wide range of medium to hard construction materials, block pavements, granite, natural stone, roof tiles and hard tiles.



MACHINES	DIA (mm)	BORE (mm)	SEGMENT H/W (mm)	PK QTY	ART NO.	PRICE
	115	22,23	12/1,8	1	70184623598	£000.00
	125	22,23	12/2,0	1	70184623599	£000.00
	230	22,23	12/2,8	1	70184623180	£000.00



EXTREME UNIVERSAL LASER **+++++**

- Up to 15mm high segments provide long life and fast cut on all building materials
- The DUO segments provide high cutting speed, improved comfort and low vibration levels
- Arrow shaped gullet slots quickly remove debris from the blade surface and indicates the rotational direction
- 'DUO' shaped cut reduces heat and cools the blade core
- Laser welded segments ensure optimum safety against segment loss



MACHINES	DIA (mm)	BORE (mm)	SEGMENT H/W (mm)	PK QTY	ART NO.	PRICE
	300*	30/25,4	15/2,8	1	70184612282	£000.00
	350*	30/25,4	15/2,8	1	70184612283	£000.00
	400	25,4	10/3,2	1	70184611438	£000.00



*Special Duo shaped segments and Duo laser cuts for 300mm & 350mm diameter blades only

PRO UNIVERSAL TURBO **++++**

- 12mm high continuous rim blade
- Ideal for universal use on general materials and stone.
- Reinforcement flanges around the bore ensure rigidity and straight cutting under the most demanding conditions.
- Use dry or wet



MACHINES	DIA (mm)	BORE (mm)	SEGMENT H/W (mm)	PK QTY	ART NO.	PRICE
	115	22,23	12/2,1	1	70184610314	£000.00
	125	22,23	12/2,1	1	70184610315	£000.00
	180	22,23	12/2,1	1	70184610317	£000.00
	230	22,23	12/2,1	1	70184610267	£000.00



PRO UNIVERSAL TP **++++**

- Segments with different thicknesses for a number of different mortar joints.
- The hard-metal protection inserts prevent under-cutting of the steel-centre and contributes to longer product life.
- For the removal of mortar joints between bricks, natural stone blocks or facing bricks.
- Removes mortar 2x faster than a standard blade



MACHINES	DIA (mm)	BORE (mm)	SEGMENT H/W (mm)	PK QTY	ART NO.	PRICE
	115	22,23	6,5/4,5	1	70184610712	£000.00
	115	22,23	6,5/6,5	1	70184610305	£000.00
	125	22,23	6,5/4,5	1	70184610713	£000.00
	125	22,23	6,5/6,5	1	70184610307	£000.00
	125	22,23	6,5/8,0	1	70184610716	£000.00



PRO UNIVERSAL LASER **++++**

- Fast cutting
- Use dry or wet cutting on masonry saws
- For use on concrete slabs and general purpose building materials



MACHINES	DIA (mm)	BORE (mm)	SEGMENT H/W (mm)	PK QTY	ART NO.	PRICE
	115	22,23	10/2,2	1	70184624738	£000.00
	125	22,23	10/2,2	1	70184624739	£000.00
	180	22,23	10/2,5	1	70184625563	£000.00
	230*	22,23	10/2,5	1	70184611396	£000.00

*Diamond shaped holes only on 230mm



CLASSIC UNIVERSAL TURBO **+++**

- An economical solution
- Continuous rimmed blade
- Use dry or wet



MACHINES	DIA (mm)	BORE (mm)	SEGMENT H/W (mm)	PK QTY	ART NO.	PRICE
	115	22,23	10/2,2	1	70184626814	£000.00
	125	22,23	10/2,2	1	70184626815	£000.00
	180	22,23	10/2,4	1	70184626816	£000.00
	230	22,23	10/2,6	1	70184626818	£000.00



DIAMOND BLADES FOR UNIVERSAL BUILDING MATERIALS

CLASSIC UNIVERSAL LASER **+++**

- An economical blade choice for dry or wet cutting on masonry saws.
- For use on construction materials and lightweight blocks, Poroton, Kalksandstein.



MACHINES	DIA (mm)	BORE (mm)	SEGMENT H/W (mm)	PK QTY	ART NO.	PRICE
	115	22,23	7/2,2	1	70184626834	£000.00
	125	22,23	7/2,2	1	70184626835	£000.00
	180	22,23	7/2,5	1	70184626837	£000.00
	230	22,23	10/2,5	1	70184626838	£000.00



CLASSIC UNIVERSAL **+++**

- An economical solution
- Sintered blade
- Use dry or wet



MACHINES	DIA (mm)	BORE (mm)	SEGMENT H/W (mm)	PK QTY	ART NO.	PRICE
	115	22,23	10/1,8	1	70184626806	£000.00
	125	22,23	10/1,8	1	70184626807	£000.00
	180	22,23	10/2,2	1	70184626809	£000.00
	230	22,23	10/2,4	1	70184626810	£000.00





DIAMOND BLADES FOR MULTI MATERIALS

Multi-purpose blades for cutting concrete, reinforced concrete, roof tiles, paviers, blocks, granite, natural stone, asphalt, breeze blocks, sandstone and gridstone.

PRODUCT SELECTION GUIDE

Highly Recommended ●
Recommended ◐



MATERIALS	PRO 4x4 EXPLORER	DIALAST
	++++	+++++
Steel	●	
Granite	●	
Engineering bricks		
Cured concrete		
Clay / pipes / paviers		
Quarry tiles	●	
Marble	◐	
Hard paviers		
Clay roof tiles		
Terrazo	●	
Facing bricks	◐	
Reinforced concrete		
Concrete paving slabs		
Concrete pipes / kerbs	●	
Slate	●	
Foundry gates / risers		●
Plastic tube & pipes		●
Composite and fibre tubes		●
Ductile iron		●
Metal Sheet and steel bar / rebar		◐
Metal studs		◐
Angle Iron		◐

4 EXPLORER 4

++++

FASTER CUTTING, LONGER LIFE, IMPROVED SAFETY & GREATER COMFORT



PRO 4X4 EXPLORER

The Pro 4x4 Explorer range is even better than before. Faster cutting, longer life, improved safety and greater comfort when used on any material are all additional benefits of this manufacturing process.

- Multipurpose blade cuts all materials
- Up to 12mm segment height for more cuts per wheel
- Trapezoid shaped segments give a comfortable, smoother cut with lower vibration levels
- Patented cut depth indicator allows better visibility of cut depth when in use
- Keep track of segment wear with the specially engraved wear indicator
- Patented drop shaped gullets prevents fatigue cracks even when cutting thick metal



APPLICATIONS

- Reinforced concrete
- Concrete lintels
- Limestone concrete
- Concrete roof tiles
- Paviments and blocks
- Granite & natural stones
- Asphalt
- Asphalt over concrete
- Breeze blocks
- Gridstone
- Sandstone
- Steel parts up to 5mm thick

MACHINES	DIA (mm)	BORE (mm)	SEGMENT H/W (mm)	PK QTY	ART NO.	PRICE
	115	22,23	10/2,2	1	70184602018	€000.00
	125	22,23	10/2,2	1	70184602019	€000.00
	180	22,23	10/2,5	1	70184602020	€000.00
	230	22,23	12/2,5	1	70184602021	€000.00
	300	20	12/3,0	1	70184602022	€000.00
	300	25,4	12/3,0	1	70184602023	€000.00
	350	20	12/3,2	1	70184602091	€000.00
	350	25,4	12/3,2	1	70184602093	€000.00
	400	25,4	12/3,2	1	70184602095	€000.00
	400	20	12/3,2	1	70184602094	€000.00
	450	25,4	12/3,2	1	70184602096	€000.00



Segment wear indicator





Patented cutting depth indicator

DIALAST **+++++**

- The DiaLast™ Chop Saw cut-off wheel is available in 350x25.4mm for use at 5,400 RPM's, the steel core provides additional stability against abuse and fractures found with conventional abrasive wheels
- The unique gullet design and laser cut core dampens cutting noise when in use, ideal for cutting indoors and out
- For cutting foundry gates or risers, sheet metal, pipes, round or sectional tubing, steel bars, rebars, angled iron, ductile iron and metal studs, longer life than conventional chop saw blades depending on the application
- Extended diamond and tool life results in less blade changes for lower labour cost and downtime



MACHINES	DIA (mm)	BORE (mm)	SEGMENT H/W (mm)	PK QTY	ART NO.	PRICE
 	350	25,4	10/50	1	70184602083	£000.00



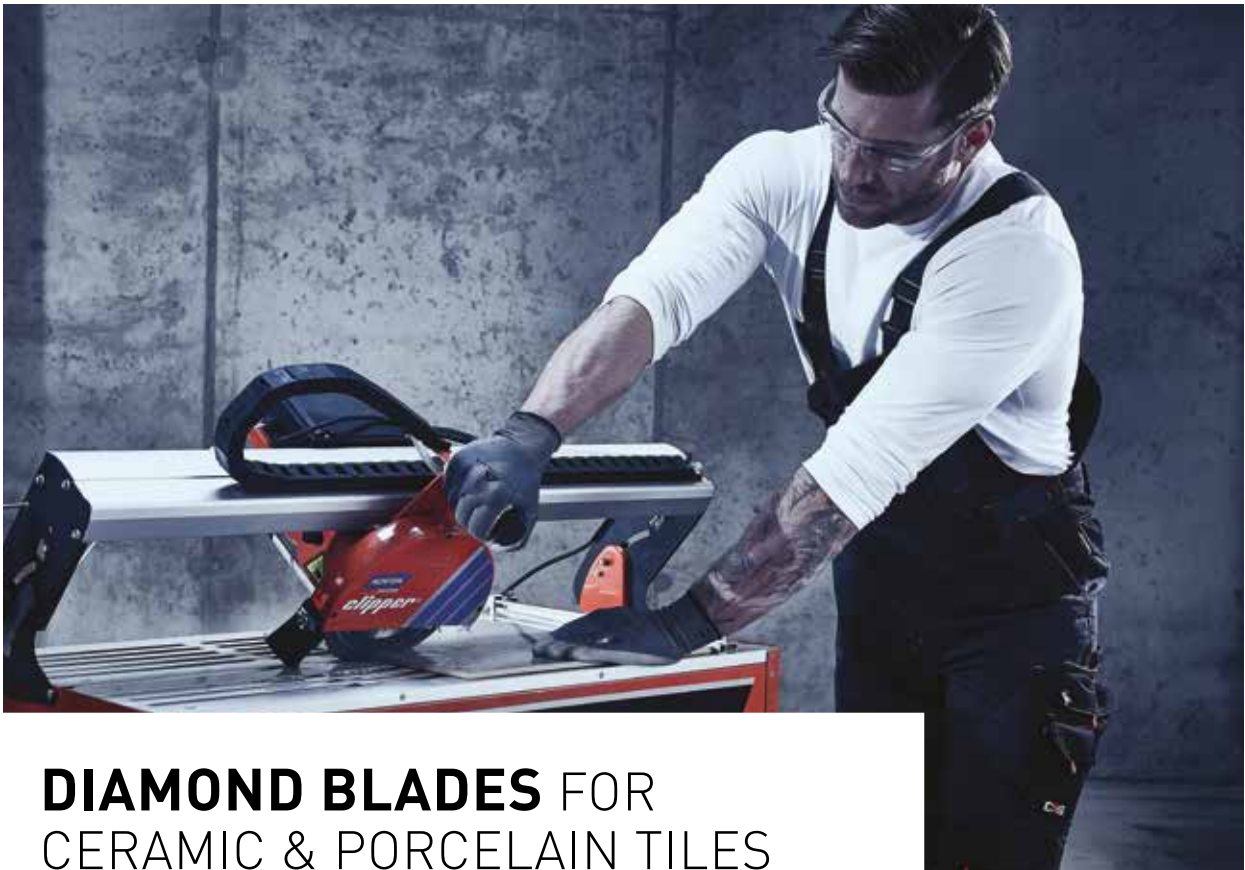

DIAMOND BLADES FOR CERAMIC & PORCELAIN TILES

Ceramic and porcelain tiles, vitrified reconstituted stone, glass, textured glass, glazed ceramic tiles, granite, marble, slate & hard natural stone.

PRODUCT SELECTION GUIDE

Highly recommended ●
Recommended ◐



MATERIALS	EXTREME CERAMIC TURBO	PRO CERAMIC	CLASSIC CERAMIC
	+++++	++++	+++
Steel			
Granite	●	◐	
Engineering bricks			
Cured concrete			
Clay/pipes/paviors		◐	
Quarry tiles	●	◐	◐
Marble	◐	●	◐
Hard paviors			
Clay roof tiles			
Terrazo	●	●	
Facing bricks	◐		
Reinforced concrete			
Concrete paving slabs			
Concrete pipes/kerbs	●		
Slate	●	●	◐



clipper®

++++ INNOVATION

**QUALITY CUTTING OF
HARD CERAMIC TILES**



EXTREME CERAMIC TURBO

- This 10mm high continuous rim blade is the perfect choice for a high quality cut.
- Premium diamond grade and free cutting metal bond make this blade perfect for cutting even the hardest tiles
- 1,4mm thickness for fast cutting and reduced material wastage
- The reinforced flange on the steel centre helps to keep the blade straight without causing damage to the tile
- For use on angle grinders, rail tile and masonry saws
- Can be used on porcelain, ceramic, vitreous, marble, terracota, granite, slate, reconstituted stone, floor and wall tiles.



MACHINES	DIA (mm)	BORE (mm)	SEGMENT H/W (mm)	PK QTY	ART NO.	PRICE
	115	22,23	10/1,4	1	70184644759	£000.00
	125	22,23	10/1,4	1	70184644760	£000.00
	200	25,4	10/1,4	1	70184625427	£000.00
	230	22,23	10/1,4	1	70184621973	£000.00
	250	25,4	10/1,6	1	70184625428	£000.00
	300	25,4	10/1,9	1	70184625429	£000.00

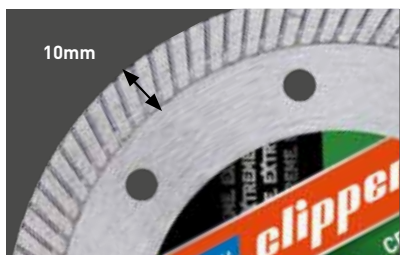

10mm high diamond rim

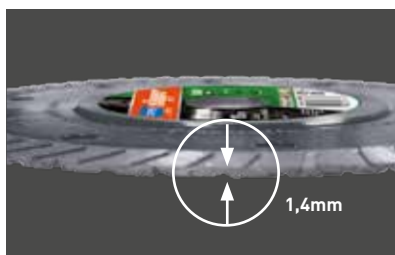

1,4mm thick blade



Fast cutting continuous rim

DIAMOND BLADES FOR CERAMIC & PORCELAIN TILES

PRO CERAMIC **++++**

- Good value for money continuous diamond rim
- Can be used for dry or wet cutting.
- For use on ceramics, granite, marble, slate, quarry tiles.



MACHINES	DIA (mm)	BORE (mm)	SEGMENT H/W (mm)	PK QTY	ART NO.	PRICE
<i>Wet & dry cutting</i>						
	115	22,23	9/1,6	1	70184625942	£000.00
	125	22,23	9/1,6	1	70184625940	£000.00
	230	22,23	9/2,2	1	70184625946	£000.00
<i>Wet cutting only</i>						
	180	25,4/22,23	9/1,6	1	70184625561	£000.00
	200	25,4	9/1,6	1	70184625093	£000.00
	230	25,4	9/1,6	1	70184625096	£000.00
	250	25,4	9/1,6	1	70184625097	£000.00
	300	25,4	9,5/2,0	1	70184625098	£000.00
	350	25,4	9,5/2,0	1	70184625100	£000.00



CLASSIC CERAMIC **+++**

- Value for money continuous rimmed diamond blade
- Dry or wet cutting of medium hard tiles and ceramic tiles.



MACHINES	DIA (mm)	BORE (mm)	SEGMENT H/W (mm)	PK QTY	ART NO.	PRICE
	115	22,23	7/1,6	1	70184626825	£000.00
	125	22,23	7/1,6	1	70184626826	£000.00
	180	25,4/22,23	7/1,7	1	70184626828	£000.00
	200	30/25,4	7/1,7	1	70184626829	£000.00
	230	22,23	7/1,8	1	70184626830	£000.00



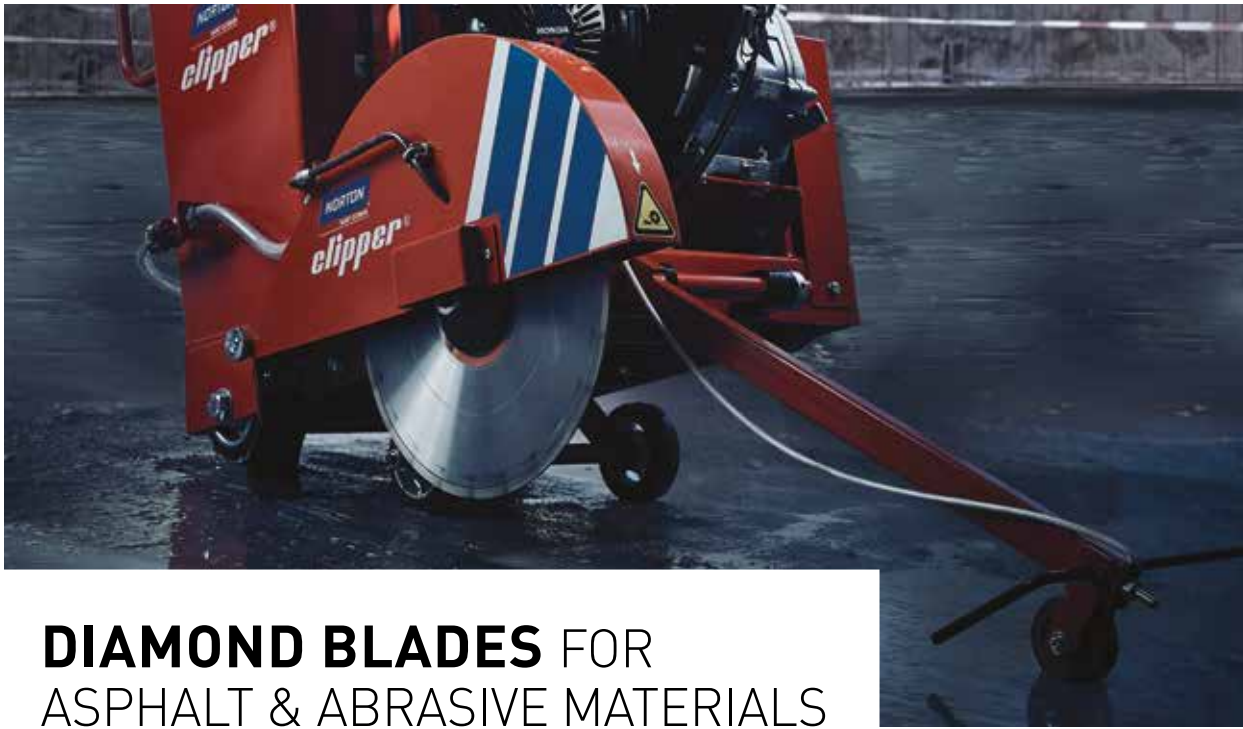





DIAMOND BLADES FOR ASPHALT & ABRASIVE MATERIALS

Asphalt, Asphalt over concrete, green concrete, bitumen, cement joints, breeze blocks, Lignacite blocks

PRO ASPHALT

- 12mm high continuous rim blade
- Ideal for universal use on general materials and stone.
- Reinforcement flanges around the bore ensure rigidity and straight cutting under the most demanding conditions.
- Use dry or wet





MACHINES	DIA (mm)	BORE (mm)	SEGMENT H/W (mm)	PK QTY	ART NO.	PRICE
 	300	25,4	10/2,8	1	70184623184	€000.00
  	350	25,4	10/3,2	1	70184623186	€000.00

QUICK FIX

The system allows for blades bore to be adjusted to fit machines with different arbor/shaft diameters. There are 2 versions, the first allows a blade with a 25,4mm bore to be fitted to a machine with a 22,23mm arbor/shaft. The second allows a blade with either a 25,4mm or 22,23mm bore to be mounted on a machine with a 20mm arbor/shaft.

The system complies with the requirements of European Standard EN 13236.

MACHINES	BORE OF BLADE (mm)	BORE OF MACHINE (mm)	ART NO.	PRICE
	22,23	10/2,2	70184623894	€000.00
	20	10/2,2	70184622589	€000.00





NORTON

SAINT-GOBAIN®

clipper®

+++++ INNOVATION

THE ULTIMATE SURFACE GRINDING PERFORMANCE



CUP GRINDERS FOR CONCRETE & BUILDING MATERIALS

Now with i-HD™ technology, Norton Clipper Extreme Cup Grinders provide the ultimate surface grinding performance.

EXTREME CG +++++ INNOVATION

- i-HD segments provide the best finish, high material removal rates and longest life thanks to the uniform density of diamonds across each whole segment
- The unique large segment design enables faster grinding of large surfaces
- Low vibrations provide better comfort during use
- Large ventilation holes mean better cooling and less heat generation
- Flat 125mm cup grinder is suitable for use on all vacuum grinders
- For use on building materials, concrete, natural stone and abrasive materials
- For tilers, general builders, concrete flooring contractors, swimming pool installers.



MACHINES	DIA (mm)	CUP HEIGHT (mm)	BORE (mm)	SEGMENT H/W (mm)	PK QTY	ART NO.	PRICE
	100	19	22,23	4,5	1	70184694991	€000.00
	125	24	22,23	4,5	1	70184694993	€000.00
	180	29	22,23	4,5	1	70184694994	€000.00
	125 FLAT	19	22,23	4,5	1	70184694992	€000.00



See page 09 for more information on merchandising displays

PRO CG **++++**

- High material removal rate
- Low vibration for better comfort when in use
- i-HD manufacturing technology ensures long life and a good standard of finishing
- For surfacing and grinding medium hardness construction and building materials (concrete, reinforced concrete, natural stone).



MACHINES	DIA (mm)	CUP HEIGHT (mm)	BORE (mm)	SEGMENT H/W (mm)	PK QTY	ART NO.	PRICE
	100	19	22,23	4,5	1	70184694988	£000.00
	125	24	22,23	4,5	1	70184694989	£000.00
	180	29	22,23	4,5	1	70184694990	£000.00

CLASSIC CG **+++**

- An economical solution
- For surfacing and grinding hard construction and building materials (concrete, reinforced concrete, natural stone).
- Smaller segments have excellent performance on on hard materials
- Flat sides avoid damaging walls or ceilings during flush grinding



MACHINES	DIA (mm)	CUP HEIGHT (mm)	BORE (mm)	SEGMENT H/W (mm)	PK QTY	ART NO.	PRICE
	100	19	22,23	4,5	1	70184694995	£000.00
	125	24	22,23	4,5	1	70184694996	£000.00
	180	29	22,23	4,5	1	70184601079	£000.00



CUP GRINDERS FOR CONCRETE & BUILDING MATERIALS

PRO CG-PCD LOW VIBRATION **++++**

- Designed for the fast removal of glue, epoxy resins & paint
- The embedded anti-vibration system provides comfort during use
- Use a concrete cup wheel after using PCD wheels to ensure a great finish.



H = 18mm



MACHINES	DIA (mm)	CUP HEIGHT (mm)	BORE (mm)	PCD ELEMENTS	PK QTY	ART NO.	PRICE
	125	18	22,23	12pcs	1	70184645886	€000.00

CLASSIC CG-PCD **+++**

- Cost-effective PolyCrystalline Diamond (PCD) cup wheel
- Designed for the fast removal of glue, epoxy resins & paint
- Use a concrete cup wheel after using PCD wheels to ensure a great finish.



H = 19mm



MACHINES	DIA (mm)	CUP HEIGHT (mm)	BORE (mm)	PCD ELEMENTS	PK QTY	ART NO.	PRICE
	125	19	22,23	12pcs	1	70184693445	€000.00

EXTREME CUT' N GRIND **+++++**

- Multi-purpose tool for cutting and grinding of building materials
- i-HD™ technology offers longer life, a faster cut and a unique design
- Can be used for the same applications as diamond blades and diamond cup grinders
- Equipped with an aluminium flange in connection M14 for offset cutting and grinding.



MACHINES	DIA (mm)	BORE (mm)	SEGMENT H/W (mm)	PK QTY	ART NO.	PRICE
	125	M14	25 / 3,9	1	70184602036	€000.00

PRO CUT' N GRIND **+++**

- Sintered Turbo shape, for fast material removal and good finishing quality in cutting and grinding
- Equipped with an aluminium flange in connection M14 for offset cutting and grinding
- Can be used for the same applications as diamond blades and diamond cup grinders
- For use on concrete, washed concrete, blocks, ductile iron and natural stones.



MACHINES	DIA (mm)	BORE (mm)	SEGMENT H/W (mm)	PK QTY	ART NO.	PRICE
	100	M14	25 / 3,9	1	70184641171	€000.00
	125	M14	25 / 3,9	1	70184641172	€000.00













DRILLING CORE BITS FOR CONCRETE

Reinforced concrete, cured concrete, kerb stones, concrete pipes, engineering bricks, facing bricks, refractory bricks, flagstones and paving stones, block paving, washed gravel concrete slabs, natural stone, flint, sandstone, limestone.

PRO CB BETON CROWNED **++++**

- Useful length: 300mm.
- Connection: 1/2" Male thread.
- Applications: for concrete and masonry walls.
- Professional crownbit for small diameters wet-drilling jobs.
- Brazed crownbit for wet-drilling.



MACHINES	DIA (mm)	USEFUL LENGTH (mm)	SEGMENT HEIGHT (mm)	PK QTY	ART NO.	PRICE
	14	300	10	1	70184612947	£000.00
	18	300	10	1	70184612824	£000.00
	22	300	10	1	70184612826	£000.00
	25	300	10	1	70184612827	£000.00
	28	300	10	1	70184612828	£000.00
	30	300	10	1	70184612829	£000.00
	32	300	10	1	70184612830	£000.00
	35	300	10	1	70184612831	£000.00
	40	300	10	1	70184612834	£000.00
	51	300	10	1	70184612835	£000.00



















DRILLING CORE BITS FOR CONCRETE

PRO CB BETON SEGMENTED

- Useful length: 450mm.
- Connection: 1 1/4" UNC female thread.
- Applications: concrete and reinforced concrete, masonry blocks. Also suitable for asphalt & abrasive materials.
- Core drills with laser welded segments for wet drilling. The special tapered-shape segments allow for an easier start of the drill.













MACHINES	DIA (mm)	USEFUL LENGTH (mm)	SEGMENT HEIGHT (mm)	PK QTY	ART NO.	PRICE
	52	450	10	1	70184624870	£000.00
	62	450	10	1	70184624872	£000.00
	72	450	10	1	70184624874	£000.00
	82	450	10	1	70184624876	£000.00
	102	450	10	1	70184624880	£000.00
	107	450	10	1	70184624881	£000.00
	112	450	10	1	70184624882	£000.00
	122	450	10	1	70184624883	£000.00
	127	450	10	1	70184624884	£000.00
	132	450	10	1	70184624885	£000.00
	152	450	10	1	70184624887	£000.00
	162	450	10	1	70184624888	£000.00
	182	450	10	1	70184624890	£000.00
	202	450	10	1	70184624892	£000.00
	252	450	10	1	70184624895	£000.00
	300	450	10	1	70184624897	£000.00



















CLASSIC CB BETON

- Useful length: 450mm.
- Connection: 1 1/4" UNC female thread.
- Applications: for concrete and masonry walls.
- Core drill with brazed segments.
- Good value for money.



MACHINES	DIA (mm)	USEFUL LENGTH (mm)	SEGMENT HEIGHT (mm)	PK QTY	ART NO.	PRICE
	51	450	10	1	70184613201	£000.00
	56	450	10	1	70184613202	£000.00
	61	450	10	1	70184613203	£000.00
	66	450	10	1	70184613204	£000.00
	71	450	10	1	70184613205	£000.00
	76	450	10	1	70184613206	£000.00
	81	450	10	1	70184613207	£000.00
	86	450	10	1	70184613208	£000.00
	91	450	10	1	70184613209	£000.00
	101	450	10	1	70184613210	£000.00



MACHINES	DIA (mm)	USEFUL LENGTH (mm)	SEGMENT HEIGHT (mm)	PK QTY	ART NO.	PRICE
	106	450	10	1	70184613211	£000.00
	111	450	10	1	70184613212	£000.00
	121	450	10	1	70184613213	£000.00
	126	450	10	1	70184613214	£000.00
	131	450	10	1	70184613215	£000.00
	141	450	10	1	70184613216	£000.00
	151	450	10	1	70184613217	£000.00
	161	450	10	1	70184613218	£000.00
	171	450	10	1	70184613219	£000.00
	181	450	10	1	70184613220	£000.00
	191	450	10	1	70184613221*	£000.00
	201	450	10	1	70184613222	£000.00
	211	450	10	1	70184613223	£000.00
	225	450	10	1	70184613252	£000.00
	251	450	10	1	70184613224	£000.00
	271	450	10	1	70184613253	£000.00
	300	450	10	1	70184613225	£000.00



Dimensions Key: DIA = Diameter





DRILLING CORE BITS FOR UNIVERSAL BUILDING MATERIALS

For masonry and light building material on hand held machines.
For plumbers and electricians.

EXTREME CB UNIVERSAL **++++**

- Useful length: 150mm
- Connection: M16 female thread
- New swirled core for reduced friction and improved dust removal
- For dry-drilling of non-reinforced masonry walls, poroton, concrete blocks and abrasive materials



MACHINES	DIA (mm)	USEFUL LENGTH (mm)	SEGMENT HEIGHT (mm)	PK QTY	ART NO.	PRICE
	52	150	7	1	70184601792	£000.00
	65	150	7	1	70184601793	£000.00
	82	150	7	1	70184601794	£000.00
	91	150	7	1	70184601874	£000.00
	102	150	7	1	70184601795	£000.00
	107	150	7	1	70184601796	£000.00
	117	150	7	1	70184601797	£000.00
	127	150	7	1	70184601798	£000.00
	152	150	7	1	70184601799	£000.00
	162	150	7	1	70184601800	£000.00
	202	150	7	1	70184601875	£000.00

Dimensions Key: DIA = Diameter



PRO CB UNIVERSAL **++++**

- Useful length: 150mm
- Connection: 1/2" BSP Female
- High performance dry core bit
- Faster drilling speed than Classic CB Universal range (formerly Arid 5)



MACHINES	DIA (mm)	USEFUL LENGTH (mm)	SEGMENT HEIGHT (mm)	PK QTY	ART NO.	PRICE
	38	150	7	1	70184640160	£000.00
	48	150	7	1	70184694047	£000.00
	52	150	7	1	70184640161	£000.00
	65	150	7	1	70184640162	£000.00
	78	150	7	1	70184640163	£000.00
	91	150	7	1	70184694048	£000.00
	107	150	7	1	70184640164	£000.00
	117	150	7	1	70184640165	£000.00
	127	150	7	1	70184640166	£000.00
	152	150	7	1	70184640167	£000.00



CLASSIC CB UNIVERSAL **+++**

- Useful length: 150mm (300mm for diam 28mm).
- Connection: 1/2" BSP Female.
- Conical connection shape to improve the mounting of the corebit
- Reduced vibration, increased safety and better comfort
- Easier core extraction.
- Optimised for the best balance between drilling speed, product life and comfort.





MACHINES	DIA (mm)	USEFUL LENGTH (mm)	SEGMENT HEIGHT (mm)	PK QTY	ART NO.	PRICE
	28	150	7	1	70184620351	£000.00
	38	150	7	1	70184620352	£000.00
	52	150	7	1	70184620353	£000.00
	65	150	7	1	70184640268	£000.00
	78	150	7	1	70184620354	£000.00
	107	150	7	1	70184620355	£000.00
	117	150	7	1	70184620356	£000.00
	127	150	7	1	70184620357	£000.00
	152	150	7	1	70184620358	£000.00



CLASSIC DS

- Useful length: 60mm (300mm for diam 28mm).
- Connection: M16 Female.
- Application: medium-hard building materials.
- Laser-welded segmented drill bit for handheld drilling. Suitable for dry drilling of electrical sockets and switches.
- Good value for money.



MACHINES	DIA (mm)	USEFUL LENGTH (mm)	SEGMENT HEIGHT (mm)	PK QTY	ART NO.	PRICE
	68	60	7	1	70184620422	£000.00
	82	60	7	1	70184620423	£000.00

TECHNICAL INFORMATION

OPERATING SPEEDS

MAXIMUM OPERATING SPEED		
DIAMETER (mm)	MAX M/S	MAX RPM
100	80	15300
115	80	13300
125	80	12250
150	80	10200
180	80	8500
200	80	7650
230	80	6650
250	80	6100
300	100	6400
350	100	5500
400	100	4800
450	63	2700

NEVER EXCEED THE MAXIMUM OPERATING SPEEDS:

- Hand held blades $\varnothing \leq 230\text{mm}$: 80m/s
- Hand held blades $\varnothing > 230\text{mm}$: 100m/s
- Others: 63m/s

PERSONAL PROTECTION

Safety goggles, ear defenders, safety gloves, dust masks and, if conditions are severe, additional face protection. Leather aprons and safety shoes must be worn.



Mouth Protection



Wear Gloves



Eye Protection



Ear Protection



Read Instructions



Not for Side Grinding



Dry Cutting



Wet Cutting

TROUBLESHOOTING

DIAMOND BLADE DOES NOT CUT

Cause	The segments are too hard for the material
Solution	Check if the blade is suitable for the material
Cause	The segments have become blunt
Solution	Sharpen the segments by cutting an abrasive material (e.g. sandstone)
Cause	Insufficient machine power
Solution	Check the voltage, machine power & filters

EXCESSIVE WEAR

Cause	The segment is too soft for the material (e.g. if a blade for hard material is used to cut abrasive material)
Solution	Check if the diamond blade is suitable for the material

CRACKING OF STEEL CENTRE

Cause	The segments are too hard for the material
Solution	Check if the blade is suitable for the material
Cause	Excessive cutting pressure, overheating, material slippage, twisting or jamming in the cut
Solution	Leave the blade to do the work, do not exert too much pressure & allow the blade to cool regularly by leaving it to rotate away from the workpiece for a few seconds

LOOSENING OR CRACKING OF SEGMENTS

Cause	The segments are too hard for the material. This results in the diamond blade bouncing in the cut resulting in cracking segments
Solution	Check if the diamond blade is suitable for the material

SCORCHING OF SEGMENTS

Cause	Excessive cutting pressure causing overheating. This is easily recognisable from the blue colouring where the segments & the steel core are welded together
Solution	Allow the diamond blade to cool regularly by rotating the blade away from the workpiece for a few seconds
Cause	The segments are too hard for the material
Solution	Check if the diamond blade is suitable for the material. Alternatively use less cutting pressure & let the blade do the work

UNDERCUTTING

Cause	Undercutting occurs when the steel core wears faster than the segment, i.e. where the segment & steel core meet. This is usually caused by materials that are highly abrasive. The cutting debris is not removed sufficiently & the steel core is affected. Undercutting is certain to occur if a diamond blade for hard materials is used to cut abrasive materials
Solution	Use a diamond blade suitable for the specific material

SAFETY ADVICE

DOs

Read the safety instructions provided by the abrasives & equipment supplier
Store abrasives in dry, frost-free conditions avoiding wide variations in temperature
Ensure that the product is suitable for its purpose
Handle, store & transport products with care
Examine all products before mounting & periodically during blade use for possible defects or damage (core flatness, fatigue cracks, undercutting, arbor hole damage...)
Check that correct mounting devices are used & that they are clean, undistorted and free from burrs
Ensure that work rests are properly adjusted & secure
Always use a correctly designed & adjusted guard (on the blade and belts)
Ensure that the workpiece is secure
Wear appropriate personal protective equipment at all times
Avoid clogging & uneven wear to ensure that the product is working efficiently
Ensure accordance between product direction arrow / machine rotation
Ensure that all machines using abrasives meet the requirements of the current European machinery directives-CE
Be aware of the hazards likely during the use of abrasives & observe the recommended precautions to be taken: <ul style="list-style-type: none"> • Bodily contact with the abrasive product at operating speed • Injury resulting from product breakage during use • Grinding debris, sparks, fumes & dust generated by the grinding process • Noise • Vibration

DON'Ts

Allow untrained people to use abrasives
Use a product that is damaged or one which has been dropped
Use a product if it cannot be properly identified
Use a machine that is not in good working order or one with defective parts
Force the abrasive onto the mounting device or modify the size of the mounting hole
Exceed the maximum operating speed marked on the product
Apply shock or excessive force to the product or let it overheat
Use mounting flanges which are not clean & flat
Tighten the mounting device excessively
Start the machine until the guard is in place & fastened securely
Continue to use a product if vibration occurs. True or replace it
Grind on the part of the product which is not designed for the operation
Start the machine with the workpiece in contact with the abrasive product
Grind material for which the product is not designed
Stop the abrasive by applying pressure to its surface, let it stop naturally
Exceed permissible rotation speeds: refer to values engraved on product
Use blades with missing segments or core cracks
Use dry products marked for wet use
Wear loose clothing, ties & jewellery



NORTON

SAINT-GOBAIN

WIRE BRUSHES & CARBIDE BURRS

Wire brushes	343
Carbide burrs	359
Bevelling tools	371
Wire wool	376

INTRODUCTION









Norton offers a range of wire brushes suitable for a wide variety of surface processing applications. The range encompasses crimped & knotted wire power wheel brushes, bevelled brushes, cup brushes, end brushes & hand brushes.

A number different types of wire are available which have been specifically selected to give the best results in any specific application.

WIRE TYPES

TEMPERED QUALITY STEEL WIRE			STAINLESS STEEL WIRE			BRASS WIRE
CRIMPED	STRAIGHT		CRIMPED	STRAIGHT		CRIMPED
						
Removing dust and smoothing low-grade and non alloy steels			Brushing and smoothing chrome-nickel steels, including stainless steel			Brushing, cleaning and smoothing brass, copper and bronze
NOSCW NOrmal Steel Crimped Wire	NOSKW NOrmal Steel Knotted Wire	NOSSW NOrmal Steel Straight Wire	STSCW STainless Steel Crimped Wire	STSKW STainless Steel Knotted Wire	STSSW STainless Steel Straight Wire	BRACW BRASS Crimped Wire

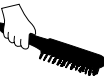
SHAPE KEY

CODE	PRODUCT TYPE	TOOL	APPLICATION
WHB	Crimped Wheel Brushes		Supplied as standard with arbour hole as indicated. The size of the arbour hole can be reduced with reduction rings. Wheel brushes with short wire are more aggressive. Larger widths require more horse power.
	Twist Knotted Wheel Brushes		Suitable for brushing out welded joints and brushing sharp corners.
BEB	Bevel Brushes		Specially designed for brushing hard-to-reach places such as edges and corners.
CPB	Crimped Cup Brushes		Use for cleaning jobs, especially on larger surfaces. Ideal for removing rust, corrosion, paint & primers. Removal of rust, corrosion, paint and primers.
	Twist Knotted Cup Brushes		An aggressive brush excellent for heavy-duty cleaning and finishing of large surfaces. Can be used for removing barnacles, scale, paint, rust and corrosion, as well as cleaning weld seams and spot-welds.
WHB/ENB	Shaft Mounted Brushes		Suitable for industrial use. Ideal for hard-to-reach areas. All shaft mounted brushes are equipped with a 6mm shank.
HCB/SPB	Hand Brushes		With wooden core. Available in different widths. For use on narrow work pieces. Ideal for light deburring & cleaning profiled surfaces.
TUB	Pipe Brushes		With handle or thread. For deburring and cleaning tubes.



WIRE BRUSHES FOR ANGLE GRINDERS

Wire brushes are excellent tools for deburring, removing rust, paint, corrosion and weld splatter from metal surfaces. They're almost spark free and with lower thermal impact, reduce the risk of workpiece burn. Norton offers a number of brush types and sizes for large flat areas to small, tight spaces. All provide a uniform finish and excellent price/performance ratio.

PRODUCT SELECTION GUIDE

FOR ANGLE GRINDERS

ANGLE GRINDER SIZE (mm)	115	125	150	180	230
BRUSH TYPES	BRUSH DIAMETER (mm)				
Wheel brush, knotted	100,115	125	150	178	-
Wheel brush, crimped	100,115	-	-	-	-
Cup brush, knotted	65	75	80	100	120
Cup brush, crimped	60	75	80,100	100	125,150

BY APPLICATION

Highly recommended ●

APPLICATIONS	WIRE DIAMETER (mm)				
	0,2	0,3	0,35	0,5	0,8
Roughening				●	●
Planing	●	●	●		
Deburring	●	●	●		
Edge honing	●	●	●		
Descaling/paint stripping	●	●	●	●	●
Weld seams	●	●	●	●	●

BY TYPE & MATERIAL

Highly recommended ●

PRODUCT AVAILABILITY ON:	STEEL	CARBON STEEL	STAINLESS STEEL	NON-FERROUS METAL	ALUMINIUM
Normal steel	●	●			
Stainless steel			●	●	●

WIRE BRUSHES FOR ANGLE GRINDERS

TWIST KNOTTED WHEEL BRUSHES



- Aggressive removal for heavy duty rust, paint, corrosion and weld splatter
- Work at high speed to finish parts faster

- Wheel shape makes it easy to access hard to reach areas
- Brush does not clog or load with surface material, for a cleaner finish

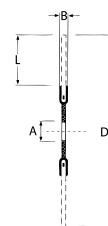

DxBxA L (mm)	NO. KNOTS	RECOMMENDED RPM	PK QTY	NORMAL STEEL		STAINLESS STEEL	
0,50 mm							
115x6x22,2 T22	36	6300 - 12500	1	63642581151	£000.00	63642581639	£000.00
125x6x22,2 T23	42	5500 - 11000	1	63642581157	£000.00	63642581640	£000.00
165x6x22,2 T35	76	4000 - 8000	1	63642581169	£000.00	-	-

TWIST KNOTTED WHEEL BRUSHES



- Powerful performance for de-burring, edge honing and removing rust, paint, corrosion and weld splatter
- Wheel shape makes it easy to access hard to reach areas

- Work at high speed to finish parts faster
- Brush does not clog or load with surface material, for a cleaner finish

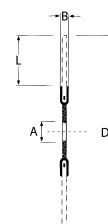

DxBxA L (mm)	RECOMMENDED RPM	PK QTY	NORMAL STEEL		STAINLESS STEEL	
0,35 mm						
100x11x22,2 T22	7500-12500	1	66254406185	£000.00	-	-
115x11xM14 T23	6300-12500	1	66254406173	£000.00	-	-
125x13x22,2 T28	5500-11000	1	66254406178	£000.00	-	-
125x13xM14 T28	5500-11000	1	66254406172	£000.00	-	-
0,50 mm						
115x11x22,2 T23	6300-12500	1	66254406167	£000.00	66254406153	£000.00
115x11xM14 T23	6300-12500	1	66254406160	£000.00	-	-
125x13x22,2 T28	5500-11000	1	66254406166	£000.00	-	-
125x13xM14 T28	5500-11000	1	66254406158	£000.00	66254410928*	£000.00
178x15x22,2 T35	4500-8500	1	66254406163	£000.00	-	-

DIMENSION KEY: D = Diameter B = Width A = Bore min L = Wire Length

* Made-to-order

TWIST KNOTTED CUP BRUSHES **+++++**

- Aggressive brush for high speed roughing, rust, paint, corrosion and weld spatter removal
- Cup shape is ideal for use on large surface areas, removing matter quickly

- Brush guard offers protection, acting as a shield against surface material, whilst retaining visibility of the workpiece
- Brush guard is flexible enough for use on flat contoured, and hard to reach areas

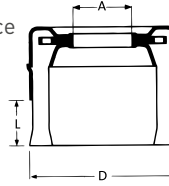

DxA L (mm)	GRINDER SIZE (mm)	PK QTY	NORMAL STEEL		STAINLESS STEEL	
			Part No.	Price	Part No.	Price
0,50 mm						
65xM14 T20	115 & 125	1	66261103046	£000.00	66261103171	£000.00



TWIST KNOTTED CUP BRUSHES **+++**

- For tough cleaning and de-burring on heavy rust, weld scale and paint
- Cup shape with rigid wire construction provides extra cleaning power on large surface areas

- Stiff, long lasting knots make light work of heavy material build-up for applications such as preparing joints for filing and scaling
- Long life thanks to anti-clog nature



DxA L (mm)	GRINDER SIZE (mm)	PK QTY	NORMAL STEEL		STAINLESS STEEL	
			Part No.	Price	Part No.	Price
0,35 mm						
65xM14 T20	115	1	66254406104	£000.00	-	-
100xM14 T25	150	1	66254406099	£000.00	-	-
0,50 mm						
65xM14 T20	115	1	66254406095	£000.00	66254406068	£000.00
80xM14 T25	125	1	66254406094	£000.00	-	-
100xM14 T25	150	1	66254406088	£000.00	-	-

* Made-to-order

WIRE BRUSHES FOR ANGLE GRINDERS

CRIMPED CUP BRUSHES **+++++**

- A multi-purpose brush for the most common cleaning jobs
- Use on large surfaces for removing rust, paint, primer fast
- Offers excellent protection against flying debris thanks to the brush guard
- Brush guard allows visibility on the workpiece

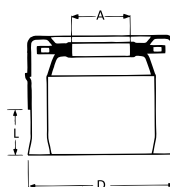

DxA L (mm)	GRINDER SIZE (mm)	PK QTY	NORMAL STEEL		STAINLESS STEEL	
			Part No.	Price	Part No.	Price
0,30 mm						
75xM14 T22	115 & 125	1	66261103049	£000.00	66261103176	£000.00

CRIMPED WIRE CUP BRUSHES **+++**

- Cup brush shape with crimped wire construction for cleaning light surface oxidation, paint and primers
- Cover large areas fast thanks to the cup shape
- Select a smaller diameter wire for lighter cleaning, thicker wire for more aggressive applications
- Long product life, thanks to anti-clog nature of the brush

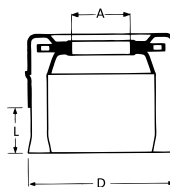

DxBxA L (mm)	GRINDER SIZE (mm)	PK QTY	NORMAL STEEL		STAINLESS STEEL	
			Part No.	Price	Part No.	Price
0,30 mm						
60xM14 T16	115	1	66254406058	£000.00	66254406037	£000.00
75xM14 T20	125	1	66254406055	£000.00	-	-
80xM14 T25	125	1	66254406054	£000.00	66254404868	£000.00
100xM14 T30	150	1	66254406053	£000.00	-	-
125xM14 T35	230	1	66254406050	£000.00	-	-
150xM14 T55	230	1	66254406049	£000.00	-	-

TWIST KNOTTED BEVEL BRUSHES **+++++**

- Bevel shape is specially designed for hard to reach areas including edges and corners
- Brush guard offers protection against flying debris, whilst still providing visibility of the workpiece
- Brush guard is flexible, allowing brush to be used on flat, open surfaces as well as hard to reach areas.
- Long product life, thanks to anti-clog nature of the brush

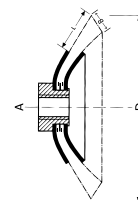

DxA L (mm)	GRINDER SIZE (mm)	PK QTY	NORMAL STEEL		STAINLESS STEEL	
			Part No.	Price	Part No.	Price
0,50 mm						
100xM14 T22	115	1	66261103055	£000.00	66261103179	£000.00

DIMENSION KEY: D = Diameter B = Width A = Bore min L = Wire Length

TWIST KNOTTED BEVEL BRUSH **+++**

- Bevel shape is specially designed for hard to reach areas including edges and corners
- For aggressive removal of rust, corrosion, paint & primer
- Stiff, long lasting knots make light work of heavy material build-up for applications such as preparing joints for filing and scaling
- Long product life, thanks to anti-clog nature of the brush

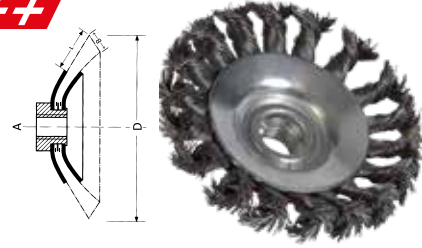

DxBxA L (mm)	GRINDER SIZE (mm)	PK QTY	NORMAL STEEL		STAINLESS STEEL	
			Part No.	Price	Part No.	Price
0,50 mm						
100x13xM14 T20	115	1	66254406149	£000.00	66254406146	£000.00
115x15xM14 T27,5	125	1	66254406147	£000.00	66254406144	£000.00

CRIMPED WIRE BEVEL BRUSHES **++++**

- Bevel shape is specially designed for hard to reach areas including edges and corners
- For removal of light rust, corrosion, paint & primer
- Brush guard offers protection against flying debris, whilst still providing visibility of the workpiece
- Long product life, thanks to anti-clog nature of the brush



DxA L (mm)	GRINDER SIZE (mm)	PK QTY	NORMAL STEEL		STAINLESS STEEL	
			Part No.	Price	Part No.	Price
0,30 mm						
100xM14 T24	115	1	66261103056	£000.00	66261103180	£000.00

CRIMPED WIRE BEVEL BRUSHES **+++**

- Bevel shape is specially designed for hard to reach areas including edges and corners
- For removal of light rust, corrosion, paint & primer
- Thick wire diameter provides more aggressive cleaning
- Long product life, thanks to anti-clog nature of the brush



DxBxA L (mm)	GRINDER SIZE (mm)	PK QTY	NORMAL STEEL	
			Part No.	Price
0,50 mm				
100x13xM14 T20	115	1	66254406142	£000.00
115x15xM14 T27,5	125	1	66254406109*	£000.00

* Made-to-order





WIRE BRUSHES FOR HAND DRILLS

Norton wire brushes for hand drills are ideal for small and hard to reach areas like inner diameters of holes and tubes. Used with medium pressure, the brushes are almost spark free, reducing thermal damage on the workpiece. A number of brush types are available for different application needs.

PRODUCT SELECTION GUIDE

BY APPLICATION

Highly recommended ●

APPLICATIONS	WIRE DIAMETER (mm)			
	0,2	0,3	0,35	0,5
Roughing			●	●
Planing	●	●	●	
Deburring	●	●	●	●
Edge honing	●	●	●	
Descaling/paint stripping		●	●	●
Weld seams	●	●	●	

BY TYPE & MATERIAL

Highly recommended ●

PRODUCT AVAILABILITY ON:	STEEL	CARBON STEEL	STAINLESS STEEL	NON-FERROUS METAL	ALUMINIUM	SOFT WOOD	HARD WOOD
	Normal steel	●	●				●
Stainless steel			●	●	●		
Brass wire				●		●	

TWIST KNOTTED WIRE WITH SHANK

- Circular shape for hard to reach areas including edges and corners
- For aggressive removal of rust, corrosion, paint & primer
- Stiff, long lasting knots make light work of heavy material build-up for preparing joints for filing and scaling
- 6mm shank fits most brands of hand drills

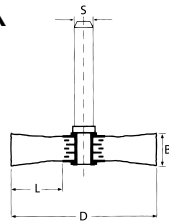

DxB L (mm)	SHANK	PK QTY	NORMAL STEEL	
0,35 mm				
70x15 T15	6	12	66254405406	£000.00
0,50 mm				
70x15 T15	6	12	66254405407	£000.00

CRIMPED WIRE WITH SHANK

- Circular shape for hard to reach areas including edges and corners
- For removal of light rust, corrosion, paint & primer
- Thicker wire diameter provides more aggressive cleaning, for less aggressive applications, choose a thinner wire
- 6mm shank fits most brands of hand drills

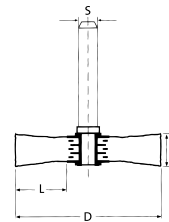

DxB L (mm)	SHANK	PK QTY	NORMAL STEEL	STAINLESS STEEL	BRASS
0,20 mm					
20x4 T3	6	10	66254404872	£000.00	-
30x6 T6,5	6	10	66254404875	£000.00	-
30x9 T6,5	6	10	66254404876	£000.00	66254404909
40x9 T9	6	10	66254404879	£000.00	66254404910
50x10 T12,5	6	10	66254404880	£000.00	-
50x15 T12,5	6	10	66254404881	£000.00	66254405238
60x10 17,5	6	10	-	-	66254405269
60x15 17,5	6	10	66254404885	£000.00	66254405270
70x10 T19	6	10	66254404886	£000.00	66254405271
80x20 T19	6	10	-	-	66254405392
0,30 mm					
50x10 T12,5	6	10	66254404891	£000.00	-
60x15 17,5	6	10	66254404897	£000.00	66254405394*
70x10 T19	6	10	66254404899	£000.00	66254405395
70x15 T19	6	10	-	-	66254405396
80x20 T19	6	10	66254404907	£000.00	66254405398

DIMENSION KEY: D = Diameter B = Width A = Bore min L = Wire Length

* Made-to-order

TWIST KNOTTED END BRUSHES

- End brush shape is perfect for heavy-duty cleaning and deburring hard to reach areas such as tubes and internal diameters
- Twist knotted wires are aggressive and remove material faster
- For use on steel, choose a larger wire diameter for more aggressive applications, for lighter work, select a smaller wire diameter
- 6mm shank fits most brands of hand drills

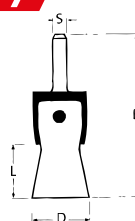

DxB L (mm)	SHANK	PK QTY	NORMAL STEEL	
0,35 mm				
19x68 T28	6	12	66254405421	£000.00
22x68 T28	6	12	66254405422*	£000.00
0,50 mm				
28x68 T28	6	12	66254405423	£000.00

* Made-to-order

CRIMPED WIRE END BRUSHES ON SHANK (ENB)

- End brush shape is perfect for cleaning and deburring hard to reach areas such as tubes and internal diameters
- Crimped wires are perfect for lighter cleaning and material removal
- For use on steel, choose a larger wire diameter for more aggressive applications, for lighter work, select a smaller wire diameter
- 6mm shank fits most brands of hand drills

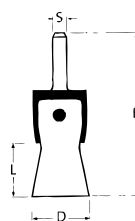

DxBxL (mm)	SHANK	PK QTY	NORMAL STEEL		STAINLESS STEEL	
0,20 mm						
12x60 T20	6	12	66254405408	£000.00	-	-
17x65 T22	6	12	66254405409	£000.00	-	-
0,30 mm						
12x60 T20	6	12	66254405410	£000.00	66254405414	£000.00
17x65 T22	6	12	66254405411	£000.00	66254405415	£000.00
24x68 T25	6	12	66254405412	£000.00	66254405418*	£000.00
30x68 T26	6	12	66254405413	£000.00	66254405419	£000.00

DIMENSION KEY: D = Diameter B = Width A = Bore min L = Wire Length

* Made-to-order





WIRE BRUSHES FOR BENCH GRINDERS

Wire wheel brushes for bench grinders are commonly used to remove rust, corrosion, hardened paint and adhesive residues, providing a good surface finish on large or small work pieces at a good price/performance ratio.

PRODUCT SELECTION GUIDE

BY APPLICATION

Highly recommended ●

APPLICATIONS	WIRE DIAMETER (mm)		
	0,2	0,3	0,5
Roughing			●
Surface preparation	●	●	
De-burring	●	●	
Edge honing	●	●	
Descaling/paint stripping	●	●	●
Weld seams	●	●	●

BY TYPE & MATERIAL

Highly recommended ●

PRODUCT AVAILABILITY ON:	STEEL	CARBON STEEL	STAINLESS STEEL	NON-FERROUS METAL	ALUMINIUM	SOFT WOOD	HARD WOOD
	Normal steel	●	●				●
Stainless steel			●	●	●		

CRIMPED WHEEL BRUSHES (WHB)

- Wheel brushes are ideal for removing corrosion, rust, hardened paints & hard adhesive residues
- Crimped wire removes light rust, corrosion, paint & primer

- Choose a larger wire diameter for more aggressive applications, for lighter work, select a smaller wire diameter
- For working on large surface areas, several wheel brushes can be mounted on the machine simultaneously

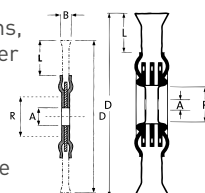

DxBxAxR L (mm)	PK QTY	NORMAL STEEL		STAINLESS STEEL	
		Code	Price	Code	Price
0,20 mm					
100x20x20x30 T24	1	66254406450	€000.00	-	-
125x24x20x30 T36	1	66254406409	€000.00	-	-
150x29x32x50,8 T27	1	66254406407	€000.00	-	-
200x26x32x80 T40	1	66254406401	€000.00	-	-
0,30 mm					
80x15x20x20 T20	1	66254406399	€000.00	-	-
100x11x12x20 T22	1	66254406455	€000.00	-	-
125x11x12x20 T34	1	66254406454	€000.00	-	-
125x24x20x30 T36	1	66254406282	€000.00	-	-
150x18x32x50,8 T27	1	66254406265	€000.00	66254406206	€000.00
180x22x32x50,8 T42	1	66254406263	€000.00	-	-
180x28x32x50,8 T42	1	66254406259	€000.00	66254406196	€000.00
200x26x32x80 T40	1	66254406255	€000.00	66254406187	€000.00
200x36x32x80 T40	1	66254406243	€000.00	-	-
250x32x50,8x100 T50	1	66254406241	€000.00	-	-
0,50 mm					
200x26x32x80 T40	1	66254406216	€000.00	-	-
250x38x50,8x100 T50	1	66254406214	€000.00	-	-

DIMENSION KEY: D = Diameter B = Width A = Bore min L = Wire Length

* Made-to-order



WIRE BRUSHES FOR MANUAL APPLICATION

Simple brushing operations can be carried out by hand using Norton manual brushes. A number of brush types are available for different applications including cleaning and removing rust, scale and paint.

PRODUCT SELECTION GUIDE

BY APPLICATION

Highly recommended ●

APPLICATIONS	TYPE OF WIRE			
	BRASS	CRIMPED	STRAIGHT	NYLON/PVC
Descaling/paint stripping		●		
Weld seams		●		
Brushing/dust removal			●	●
Light cleaning	●			●

BY TYPE & MATERIAL

Highly recommended ●

PRODUCT AVAILABILITY ON:	STEEL	CARBON STEEL	STAINLESS STEEL	NON-FERROUS METAL	ALUMINIUM	SOFT WOOD	HARD WOOD
	Normal steel	●	●				●
Stainless steel			●	●	●		
Brass wire				●		●	

WIRE BRUSHES FOR MANUAL APPLICATION

BRUSHES WITH HANDLE

- Basic hand brush for simple cleaning jobs in hard to reach or small areas
- Plastic handle for better grip and comfort in use
- Choose a larger wire diameter for more aggressive applications, for lighter work, select a smaller wire diameter

L1xL2xL (mm)	NUMBER OF ROWS	PK QTY	ARTICLE NO.	PRICE
WOOD HANDLE NORMAL STEEL STRAIGHT WIRE 0,30 mm				
290x140x25	1R	12	66254405431	£000.00
290x140x25	2R	12	66254405432	£000.00
290x140x25	3R	12	66254405434	£000.00
290x140x25	4R	12	66254405435	£000.00
290x140x25	5R	12	66254405437	£000.00
WOOD HANDLE STAINLESS STEEL STRAIGHT WIRE 0,30 mm				
290x140x25	2R	12	66254405443	£000.00
290x140x25	4R	12	66254405447	£000.00
WOOD HANDLE STAINLESS STEEL CRIMPED WIRE 0,30 mm				
290x140x25	2R	12	66254405457	£000.00
290x140x25	4R	12	66254405461	£000.00
WOOD HANDLE BRASS CRIMPED WIRE 0,30 mm				
290x140x25	4R	12	66254405466	£000.00
290x140x25	6R	12	66254405468	£000.00
PLASTIC HAND NORMAL STEEL STRAIGHT WIRE 0,30 mm				
265x140x25	1R	12	66254405470	£000.00
PLASTIC HAND STAINLESS STEEL STRAIGHT WIRE 0,30 mm				
265x140x25	1R	12	66254405471	£000.00
PLASTIC HAND BRASS CRIMPED WIRE 0,30 mm				
265x140x25	1R	12	66254405473	£000.00

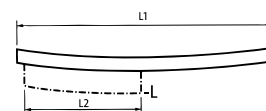

DIMENSION KEY: D = Diameter B = Width A = Bore min L = Wire Length

* Made-to-order

SPECIAL HAND BRUSHES

SPARK PLUG BRUSHES

L1xL2xL (mm)	WIRE	ROWS	PK QTY	ARTICLE NO.	PRICE
SPB					
200x18x45	0,20	3x6R	24	66254405474	£000.00



PIPE BRUSHES WITH HANDLE

- Pipe brush cleans and descales internal diameter of pipes
- Flexible metal shaft allows cleaning around bends and corners
- Choose a larger wire diameter for more aggressive applications, for lighter work, select a smaller wire diameter

DxLxL1 (mm)	PK QTY	ARTICLE NO.	PRICE
NORMAL STEEL CRIMPED WIRE 0,10 mm			
10x100x300	20	66254405706	£000.00
12x100x300	20	66254405704	£000.00
NORMAL STEEL CRIMPED WIRE 0,20 mm			
20x100x300	20	66254405715	£000.00
BRASS CRIMPED WIRE 0,10 mm			
10x100x300	20	66254405725	£000.00
18x100x300	20	66254405728	£000.00
BRASS CRIMPED WIRE 0,15 mm			
20x100x300	20	66254405730	£000.00
NYLON WIRE 0,10 mm			
10x100x300	20	66254405734	£000.00
15x100x300	20	66254405737	£000.00

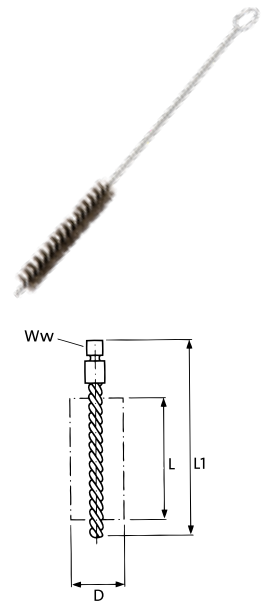

PIPE BRUSHES WITH SHANK

DxLxL1 (mm)	W/w	PK QTY	ARTICLE NO.	PRICE
NORMAL STEEL CRIMPED WIRE 0,20 mm				
18x80x115	6	10	66254405502	£000.00
25x80x115	6	10	66254405503	£000.00
NORMAL STEEL CRIMPED WIRE 0,30 mm				
32x100x160	1/2"BSW	5	66254405634	£000.00

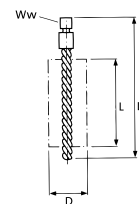

LONG SHAFT FOR PIPE BRUSHES WITH SHANK

D (mm)	SHANK / W/w	WIRE Ø	PK QTY	ARTICLE NO.	PRICE
DOU					
1000	6	-	1	66254405629	£000.00
1000	1/2"BSW	-	1	66254405692	£000.00

DIMENSION KEY: D = Diameter B = Width A = Bore min L = Wire Length



OPERATING SPEED





Peripheral speed is a decisive factor in achieving optimum performance from a brush, the table opposite enables you to determine the relevant peripheral speed by simply reading down and across the appropriate diameter and drive shaft operating speed columns.

RPM	BRUSH DIAMETER (mm)												
	20	40	50	80	100	125	150	180	200	250	300	350	
min ⁻¹	-	-	-	-	-	-	-	-	-	-	-	-	-
800	-	-	-	3,35	4,19	5,23	6,28	7,53	8,37	10,47	12,56	14,75	-
900	-	-	2,35	3,77	4,71	5,88	7,06	8,48	9,41	11,77	14,12	16,47	-
1150	-	-	3,01	4,81	6,01	7,52	9,02	10,83	12,03	15,04	18,04	21,04	-
1200	1,26	2,51	3,14	5,02	6,28	7,85	9,41	11,3	12,55	15,69	18,83	21,97	-
1400	1,46	2,93	3,66	5,86	7,32	9,15	10,98	13,18	14,64	18,31	21,97	25,63	-
1500	1,57	3,14	3,92	6,28	7,85	9,81	11,77	14,13	15,69	19,61	23,54	27,46	-
1800	1,88	3,77	4,71	7,54	9,41	11,77	14,12	16,95	18,83	23,54	28,24	32,95	-
2000	2,09	4,19	5,23	8,37	10,26	13,08	15,69	18,84	20,92	26,15	31,38	36,61	-
2500	2,62	5,23	6,54	10,47	13,08	16,35	19,61	23,55	26,15	32,67	39,23	45,76	-
2800	2,93	5,86	7,32	11,72	14,64	18,31	21,97	26,37	29,29	36,61	43,93	51,25	-
3000	3,14	6,28	7,85	12,56	15,69	19,62	23,54	28,26	31,38	39,23	47,07	54,92	-
3200	3,35	6,7	8,37	13,4	16,74	20,92	25,1	30,14	33,47	41,84	50,21	58,58	-
3500	3,66	7,33	9,15	14,65	18,31	22,89	27,46	32,97	36,61	45,76	54,92	64,07	-
4000	4,19	8,37	10,46	16,75	20,92	26,16	31,38	37,68	41,84	52,33	62,76	73,22	-
4500	4,7	9,42	11,77	18,84	23,54	29,43	35,3	42,4	47,07	58,84	70,61	82,43	-
5000	5,23	10,47	13,08	20,93	26,15	32,7	39,23	47,1	52,33	65,38	78,5	-	-
5400	5,65	11,3	14,12	22,94	28,24	35,31	42,36	50,67	56,48	70,61	84,78	-	-
6000	6,28	12,56	15,69	25,12	31,38	39,24	47,07	56,52	62,76	78,5	-	-	-
7000	7,33	14,66	18,31	29,31	36,61	45,78	54,92	65,94	73,22	91,58	-	-	-
8000	8,37	16,75	20,92	33,94	41,48	52,32	62,76	75,36	83,73	-	-	-	-
9000	9,42	18,84	23,54	37,68	47,07	58,86	70,61	84,78	94,2	-	-	-	-
10000	10,47	20,93	26,17	41,86	52,33	65,4	78,5	94,2	-	-	-	-	-
12500	13,08	26,17	32,71	52,33	65,42	81,75	98,13	-	-	-	-	-	-
15000	15,7	31,4	39,25	62,8	-	-	-	-	-	-	-	-	-
17500	18,32	36,63	45,79	73,26	-	-	-	-	-	-	-	-	-
20000	20,93	41,87	52,33	83,73	-	-	-	-	-	-	-	-	-
22500	23,55	47,1	58,88	94,2	-	-	-	-	-	-	-	-	-
25000	26,17	52,33	65,42	104,66	-	-	-	-	-	-	-	-	-

HOW TO READ THIS TABLE?

Select your brush diameter, then move down till you reach desirable peripheral speed in m/s, after check on the left side of the table the value for the RPM. Check on page 466 the maximum operating speed per type of brush.

MAXIMUM OPERATING SPEED

TYPE	DIAMETER (mm)	MAX RPM	TYPE	DIAMETER (mm)	MAX RPM
 WHEEL BRUSHES	80	10000	 BEVEL BRUSHES	100	11000
	100	8000		100/115	11000
	125	6000		115	10000
	150	6000	 TWIST KNOTTED WHEEL BRUSHES	100	11000
	180	6000		115	11000
	200	4500		125	10000
	250	3600		150/180	8500
	250 - 1 row	3500		200	6500
300	3000	20	20000		
 CUP BRUSHES	60/65/75	11000	 SHAFT MOUNTED WIRE BRUSHES	30	20000
	60/65/75	11000		40	18000
	60/65/75	10000		50	15000
	75	9300		60	15000
	80/100	8500		70	15000
	125/150	6500		80	12000

The maximum RPM ratings are safety ratings not recommended operating speeds. The optimum operating speed is determined by the application and in most cases lower operating speeds will prove more efficient and achieve the best result. As a general guide we recommend the following peripheral speeds when working on the materials listed with:

APPLICATION	CRIMPED WIRE	TWIST KNOTTED
STEEL	30m/s	35-40m/s
NON FERROUS	18-20m/s	-
PLASTIC	15m/s	-

BRUSHING PRESSURE

- Let the tip of the wire brush do the work. Operate the brush with the lightest pressure so only the tips of the wire come in contact with the work
- If heavy pressure is used, wires will be over stressed, resulting in a wiping action, and if this is continued, the life of the brush will be shortened due to wire fatigue
- Apply the work to the face of the brush ensuring as much of the brush face as possible is in full contact. Applying the work to the side or edge of the brushing tool will result in wire breakage and shortened brush life
- Reversing the wheel brush rotation periodically will tend to increase the life of the brush. This results in the sharpening of the wire tips or ends, ensuring faster cutting action

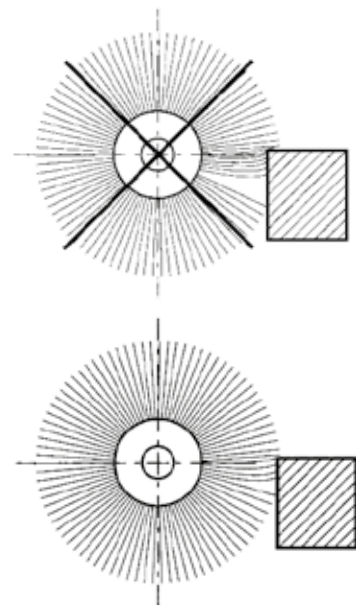

SIZE OF WIRE

- Use the finest size of wire suitable for the application
- Finer wire size will perform better and last longer than heavier

TROUBLESHOOTING

Several factors can influence a brush application. If the selected brush does not achieve the expected result, the following table may provide solutions for the most common problems faced by a user. For further information, please contact our technical department.

PROBLEM	RECOMMENDED ACTIONS
Brush is too aggressive	Increase trim length
	Reduce wire diameter
	Reduce operating speed
Brush is not aggressive enough	Reduce trim length
	Increase wire diameter
	Increase operating speed
Action of brush does not totally remove scale	Reduce trim length
	Increase wire diameter
Finish is too coarse	Increase trim length
	Reduce wire diameter
	Increase operating speed
	Choose a nylon abrasive brush
Finish is too smooth	Reduce trim length
	Increase wire diameter
Action of brush is not uniform	Reduce brushing pressure
	Automate operations to avoid human inaccuracy
Wire breaks more than usual	Reduce brushing pressure
	Reduce wire diameter
	Reduce operating speed
Life of the brush is too short	Reduce wire diameter
	Increase brush diameter
	Reduce brushing pressure

SAFETY & STORAGE

Safety goggles or full face protection with side shields must be worn by all operators and others in the immediate area of power brush operations.

- Keep all machine guards in place
- Observe all speed restrictions indicated on brushes
- Appropriate protective clothing and equipment must be used
- Brushes should be carefully checked when removed from the original carton. Do not use if rusted or damaged
- Store brushes in the original carton. Wire brushes should not be exposed to heat, high humidity, acids, fumes or liquids that can result in deterioration of the wire filaments, and subsequently, premature failure of the wires. Also, check for distortion of brush fill that can cause imbalance and excessive vibration when the brush is running
- Check maximum spindle speed. Do not mount and operate the brush if spindle RPM exceeds the maximum safe free speed for which the brush is rated. Spindle length should be sufficient to permit a full nut mounting
- Before starting the machine, rotate the wire brush with a gloved hand to determine that the brush has been correctly mounted and turns freely



TUNGSTEN CARBIDE BURRS

State of the art, "Inox" & "Steel" cut styles and round edge burrs brings innovation to the Norton carbide burr offering. The specially designed geometries suit growing demands for stainless steel, steel and cast steel offering fast stock removal and long service life, providing optimum efficiency.

This extended line of carbide burrs covers a variety of teeth and cutting shapes providing optimum results in preparing and removing welds, chamfering, deburring in the shipbuilding, automotive, foundry and aviation industries.

Carbide burrs can be used on with hand-held tools or CNC machines. Each carbide burr is packed individually in a plastic case.

UNDERSTANDING THE PRODUCT

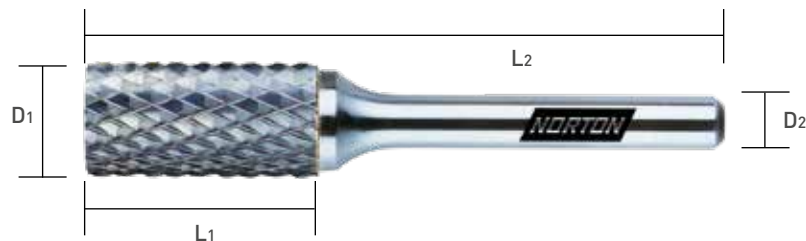

BURR DIMENSIONS & DESCRIPTION

A 16,0 x 25,0 6 x 65 DTECH							
SHAPE	HEAD DIAMETER	X	HEAD LENGTH	SHANK DIAMETER	X	OVERALL BURR LENGTH (OL)	CUT STYLE
	D ₁		L ₁	D ₂		L ₂	

CARBIDE BURRS

CUT STYLES

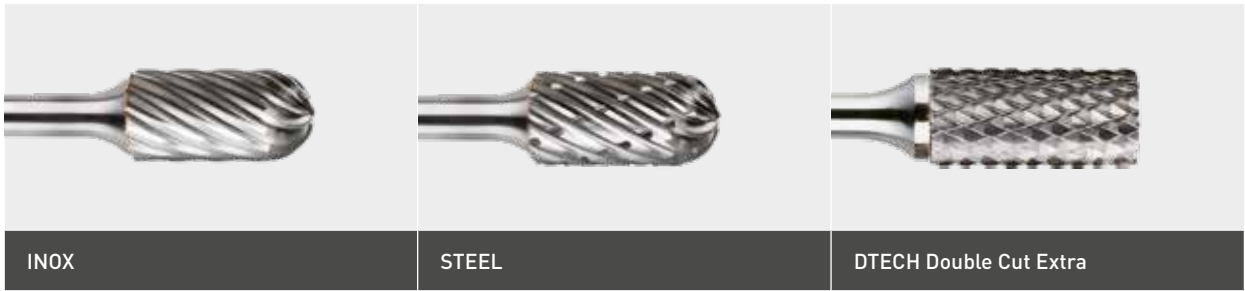

Developed cutting geometry - generating high stock removal on stainless steel and on Ferritic, Austenitic & Martensitic based materials, ensuring production savings and reduced downtime, reducing heat buildup at the cutting edge and work piece.

Specially designed geometry to suit growing market demands for steel and cast steel applications, producing large chips with increased stock removal.

Better stock removal. Stronger tooth formation (decreased tooth wedge angle) longer tool life and reduced chipping.



Universal cutting style, fast material removal, smooth finish and granular chip break.

For deburring of aluminium alloys & plastic wide tooth formation, easy chip flow.

PRODUCT RECOMMENDATION GUIDE

Highly recommended ●
Recommended ○

	INOX	STEEL	DTECH DOUBLE CUT EXTRA	D DOUBLE CUT	ALU ALUMINIUM SPECIAL
Stainless steel	●		○		
Hardened steel		●	○		
Cast Iron			●	○	
Titanium				●	
Nickel				●	
Copper/ copper alloys				●	
Aluminium					●
Plastics / wood					●

APPLICATION BY SHAPE

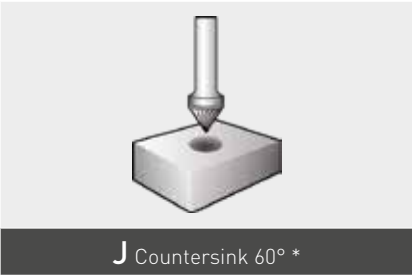
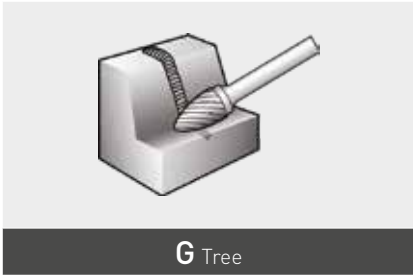
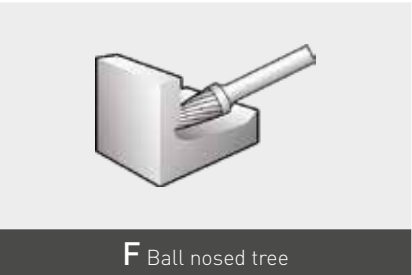
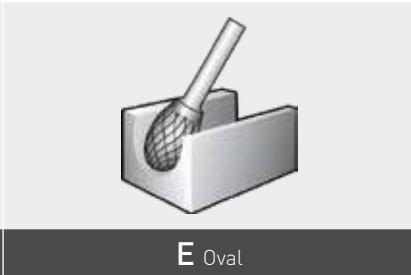
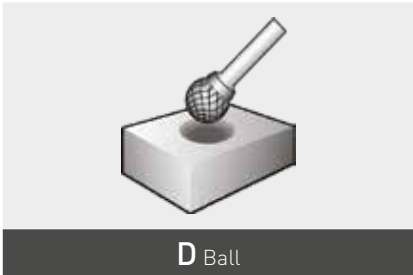
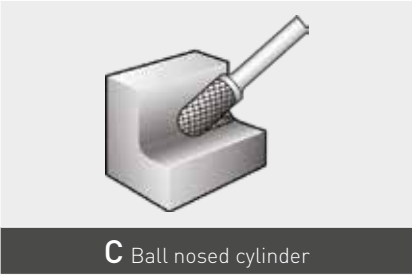
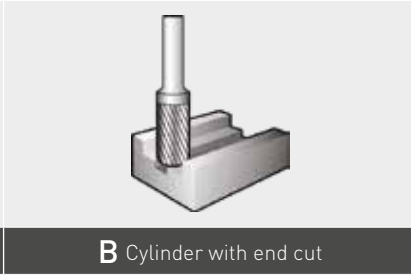
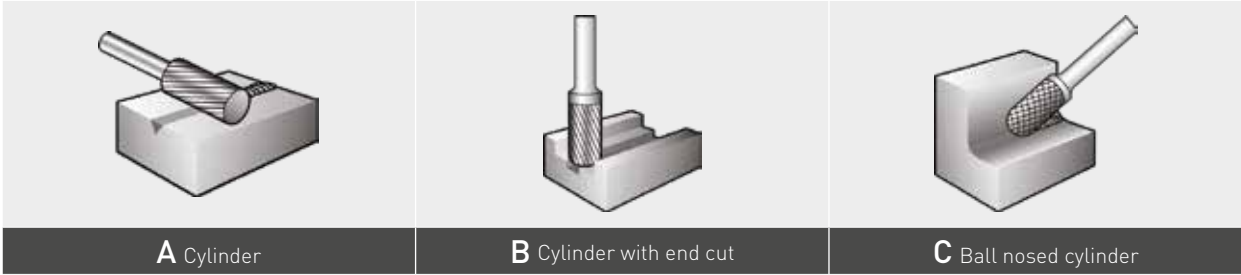

* Made-to-order



* Made-to-order

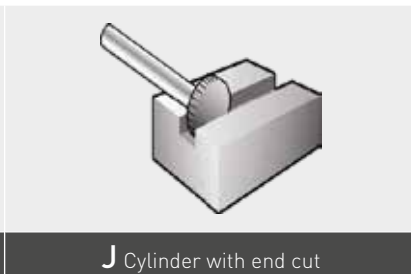







* Made-to-order

CARBIDE BURRS

FOR STAINLESS STEEL **+++++**

- Cut INOX style for high stock removal on stainless steel
- Reduced heat generation on the workpiece
- Aggressive cut creates large chips for a faster finish
- Work faster with reduced downtime for production savings









PRODUCT SHAPE	D ₁ xL ₁ xD ₂ xL ₂ (mm)	PK QTY	ARTICLE NO.	PRICE
A CYLINDER				
	6x18x6x50	1	66261121900	£000.00
	8x19x6x64	1	66261121901	£000.00
	10x19x6x64	1	66261121902	£000.00
	13x25x6x70	1	66261121911	£000.00
C BALL NOSED CYLINDER				
	6x18x6x50	1	66261121912	£000.00
	8x19x6x64	1	66261121920	£000.00
	10x19x6x64	1	66261121921	£000.00
	13x25x6x70	1	66261121922	£000.00
D BALL				
	6x5x6x50	1	66261122103	£000.00
	8x6x6x52	1	66261122107	£000.00
	10x8x6x54	1	66261122108	£000.00
	13x11x6x56	1	66261122109	£000.00
F BALL NOSED TREE				
	6x18x6x50	1	66261122110	£000.00
	8x20x6x65	1	66261122111	£000.00
	13x25x6x70	1	66261122115	£000.00
G TREE				
	8x19x6x64	1	66261122118	£000.00
	13x25x6x70	1	66261122120	£000.00
L BALL NOSED CONE				
	8x25x6x70	1	66261122122	£000.00
	13x32x6x77	1	66261122125	£000.00
INOX KIT				
	A 13x25x6x70	1	66261122126	£000.00
	C 13x25x6x70	1		
	F 13x25x6x70	1		
	G 13x25x6x70	1		
	L 13x32x6x77	1		

FOR STEEL **+++++**

- Cut STEEL style for best results on steel
- Reduced heat generation on the workpiece
- Aggressive cut creates large chips for a faster finish
- Work faster with reduced downtime for production savings



PRODUCT SHAPE	D ₁ xL ₁ xD ₂ xL ₂ (mm)	PK QTY	ARTICLE NO.	PRICE
B CYLINDER WITH END CUT				
	6x18x6x50	1	66261121688	£000.00
	10x19x6x64	1	66261121692	£000.00
	13x25x6x70	1	66261121694	£000.00
C BALL NOSED CYLINDER				
	6x18x6x50	1	66261121748	£000.00
	8x19x6x64	1	66261121749	£000.00
	10x19x6x64	1	66261121750	£000.00
	13x25x6x70	1	66261121751	£000.00
D BALL				
	6x5x6x50	1	66261121753	£000.00
	8x6x6x52	1	66261121755	£000.00
	10x8x6x54	1	66261121756	£000.00
F BALL NOSED TREE				
	6x18x6x50	1	66261121759	£000.00
	8x20x6x65	1	66261121760	£000.00
	10x19x6x64	1	66261121747	£000.00
	13x25x6x70	1	66261121762	£000.00
G TREE				
	8x19x6x64	1	66261121764	£000.00
	10x19x6x64	1	66261121765	£000.00
	13x25x6x70	1	66261121766	£000.00
L BALL NOSED CONE				
	10x30x6x76	1	66261121768	£000.00
	13x32x6x77	1	66261121769	£000.00
STEEL KIT				
	A 13x25x6x70	1	66261121783	£000.00
	C 13x25x6x70	1		
	F 13x25x6x70	1		
	G 13x25x6x70	1		
	L 13x32x6x77	1		

CARBIDE BURRS

FOR CAST IRON & SOFT STEELS





DOUBLE CUT EXTRA COATED **+++++**

- 'DTECH' Double cut EXTRA style, coated with TiLAN (titanium aluminium nitride) for better sliding characteristics
- Reduced heat generation on the workpiece
- Excellent chip removal and reduced wear of teeth
- Reduces cutting pressure required due to improved lubrication





DOUBLE CUT EXTRA **++++**

- 'DTECH' Double cut EXTRA cut style
- Good stock removal & strong tooth formation thanks to decreased tooth wedge angle
- Longer tool life and reduced chipping
- A number of sizes available for a variety of applications

PRODUCT SHAPE	D ₁ xL ₁ xD ₂ xL ₂ (mm)	PK QTY	DOUBLE CUT EXTRA COATED		DOUBLE CUT EXTRA	
B CYLINDER WITH END CUT						
	10x19x6x65	1	-	-	07660739844*	£000.00
	12x25x6x70	1	-	-	60157638174	£000.00
C BALL NOSED CYLINDER						
	10x19x6x65	1	-	-	07660739841	£000.00
	12x25x6x70	1	-	-	60157638175	£000.00
F BALL NOSED TREE						
	12x30x6x75	1	69957383321*	£000.00	63642587067	£000.00
L BALL NOSED CONE						
	10x9x6x53	1	69957383279	£000.00	07660707832	£000.00

* Made-to-order

DOUBLE CUT EXTRA KITS FOR SPECIAL APPLICATIONS

KIT	SHAPE	D ₁ xL ₁ xD ₂ xL ₂ (mm)	PK QTY	ARTICLE NO.	PRICE
 BURRS KIT x10 CUT DTECH	A	10x19x6x65	1	7660739870*	£000.00
	A	12x25x6x70	1		
	C	10x19x6x65	1		
	C	12x25x6x70	1		
	L	12x30x6x75	1		
	E	10x16x6x60	1		
	G	10x19x6x65	1		
	G	12x25x6x70	1		
	D	12x10,8x6x55	1		
	F	12x25x6x70	1		
 SOFT STEEL X4 PEICE KIT	C	12x25x6x70	1	66254428281	£000.00
	D	10x9x6x53	1		
	F	12x25x6x70	1		
	L	12x30x6x75	1		

* Made-to-order

CARBIDE BURRS

FOR TITANIUM, NICKEL, COPPER & COPPER ALLOYS

DOUBLE CUT EXTRA COATED **+++++**

- "D" Double cut style, coated with TiLAN (titanium aluminium nitride) for better sliding characteristics
- Universal cutting style for fast material removal, smooth finish & granular chip break
- Excellent chip removal and reduced wear of teeth
- Reduces cutting pressure required due to improved lubrication



BDX DOUBLE CUT **+++**





- Unique geometry improves operator control and reduces the size of chips.
- Increased cut rate and longer life on tough applications.
- "D" Double cut style.
- Universal cutting style for fast material removal

PRODUCT SHAPE	D ₁ xL ₁ xD ₂ xL ₂ (mm)	PK QTY	DOUBLE CUT EXTRA COATED		BDX DOUBLE CUT +++	
A CYLINDER						
	3x13x3x38	1	-	-	63642586518	£000.00
	6x19x6x50	1	-	-	66261146394	£000.00
	8x19x6x65	1	-	-	66261146396	£000.00
	10x19x6x65	1	-	-	66261146496	£000.00
	10x25x6x162	1	-	-	63642535764	£000.00
	12x25x6x70	1	69957383219	£000.00	66261146497	£000.00
	16x25x6x70	1	-	-	60157638148	£000.00
B CYLINDER WITH END CUT						
	3x13x3x38	1	-	-	60157638140	£000.00
	6x19x6x50	1	-	-	63642586641	£000.00
	8x19x6x65	1	-	-	7660707804	£000.00
	8x19x6x175	1	-	-	63642535757	£000.00
	10x19x6x65	1	-	-	66261146498	£000.00
	12x25x6x70	1	-	-	66261146499	£000.00
	16x25x6x70	1	-	-	66261146500	£000.00
C BALL NOSED CYLINDER						
	3x13x3x38	1	-	-	63642586710	£000.00
	6x13x6x162	1	-	-	63642535773	£000.00
	6x16x6x80	1	-	-	66261197806	£000.00
	6x19x6x50	1	69957383234	£000.00	66261146521	£000.00
	8x19x6x65	1	-	-	66261146524	£000.00
	10x19x6x65	1	-	-	66261146526	£000.00
	12x19x6x65	1	-	-	60157638153	£000.00
	12x25x6x70	1	69957383241	£000.00	66261146531	£000.00
	16x25x6x70	1	-	-	66261146532	£000.00

PRODUCT SHAPE	D ₁ xL ₁ xD ₂ xL ₂ (mm)	PK QTY	DOUBLE CUT EXTRA COATED		BDX DOUBLE CUT +++	
D BALL						
	6x5,4x6x50	1	-	-	66261146533	£000.00
	8x7,2x6x52	1	-	-	66261146534	£000.00
	10x9x6x53	1	69957383279	£000.00	66261146535	£000.00
	12x10,8x6x55	1	-	-	66261146536	£000.00
E OVAL						
	6x10x6x50	1	-	-	63642586892	£000.00
	10x16x6x60	1	-	-	60157638159	£000.00
	12x22x6x67	1	-	-	60157638162	£000.00
F BALL NOSED TREE						
	6x16x6x50	1	69957383296	£000.00	66261146537	£000.00
	6x18x6x150	1	-	-	66623391628	£000.00
	8x20x6x150	1	-	-	66623382151	£000.00
	10x19x6x65	1	-	-	66261146539	£000.00
	12x25x6x70	1	69957383301	£000.00	66261146540	£000.00
	12x25x8x70	1	-	-	60157638172	£000.00
	16x25x6x70	1	-	-	66261146541	£000.00
G TREE						
	3x12x3x38	1	-	-	60157638163	£000.00
	6x16x6x50	1	69957383305	£000.00	66261146542	£000.00
	10x19x6x65	1	69957383307	£000.00	66261146545	£000.00
	12x25x6x70	1	-	-	66261146547	£000.00
	16x25x6x70	1	-	-	66261146548	£000.00
H FLAME						
	8x19x6x65	1	-	-	60157638160	£000.00
	12x32x6x77	1	69957383312	£000.00	63642587971	£000.00
L BALL NOSED CONE						
	6x16x6x50	1	-	-	60157638156	£000.00
	8x19x6x69	1	-	-	66261146549	£000.00
	10x27x6x75	1	-	-	66261146550	£000.00
	12x30x6x75	1	69957383320	£000.00	66261146552	£000.00
M CONE						
	6x19x6x50	1	-	-	63642587137	£000.00
	10x16x6x65	1	-	-	63642587133	£000.00
	12x22x6x70	1	-	-	60157638149	£000.00

CARBIDE BURRS

MINI CARBIDE BURRS KITS

KIT	SHAPE	D ₁ xL ₁ xD ₂ xL ₂ (mm)	PK QTY	ARTICLE NO.	PRICE
MINI BURRS KIT x10 CUT D NORTON 	A	3x13x3x38	1	7660708056	£000.00
	B	3x13x3x38	1		
	M	3x11x3x38	1		
	C	3x13x3x38	1		
	L	3x8x3x38	1		
	H	3x8x3x38	1		
	E	3x6x3x38	1		
	G	3x13x3x38	1		
	D	3x2,7x3x39	1		
	F	3x13x3x38	1		
MINI BURRS KIT x 5 CUT D 	A	10x19x6x65	1	63642553618	£000.00
	C	12x25x6x70	1		
	F	12x25x6x70	1		
	G	10x19x6x65	1		
	L	12x30x6x75	1		
MINI BURRS KIT x 5 BRASS, BRONZE, COPPER 	C	12x25x6x70	1	66254428265	£000.00
	D	10x9x6x53	1		
	F	12x25x6x70	1		
	L	12x30x6x75	1		
NEW DOUBLE CUT KIT 	B	10x19x6x65	1	69957365977	£000.00
	C	10x19x6x65	1		
	D	10x9x6x53	1		
	E	10x16x6x60	1		
	G	10x19x6x65	1		



FOR CAST IRON & SOFT STEELS



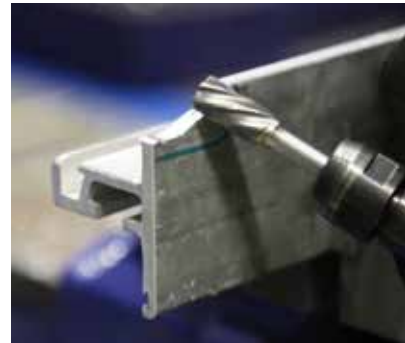

ALU COATED **++++**

- 'ALU' cut style, coated with TiLAN (titanium aluminium nitride) for better sliding characteristics
- Reduced heat generation on the workpiece
- Excellent chip removal and reduced wear of teeth
- Reduces cutting pressure required due to improved lubrication



ALU **++++**

- 'ALU' cut style, for de-burring aluminium alloys and plastic
- A number of sizes available for a variety of applications
- Wide tooth formation for easy chip flow

PRODUCT SHAPE	D ₁ xL ₁ xD ₂ xL ₂ (mm)	PK QTY	ALU COATED		ALU	
A CYLINDER						
	10x19x6x65	1	-	-	60157638195	£000.00
	12x25x6x70	1	-	-	63642586517	£000.00
B CYLINDER WITH END CUT						
	10x19x6x65	1	-	-	07660739845	£000.00
C BALL NOSED CYLINDER						
	10x19x6x65	1	-	-	60157638182	£000.00
	12x25x6x70	1	69957383278	£000.00	07660707846	£000.00
F BALL NOSED TREE						
	10x19x6x65	1	-	£000.00	63642586951	£000.00
	12x25x6x70	1	69957383303	£000.00	60157638181	£000.00
L BALL NOSED CONE						
	6x16x6x50	1	-	-	63642587095	£000.00
	12x30x6x75	1	69957383325	£000.00	63642587101	£000.00

ALU BURR KIT FOR CAST IRON & SOFT STEELS **++++**

KIT	SHAPE	D ₁ xL ₁ xD ₂ xL ₂ (mm)	PK QTY	ARTICLE NO.	PRICE
	C	12x25x6x70	1		
	D	10x9x6x53	1		
	F	12x25x6x70	1	66254428260	£000.00
	L	12x30x6x75	1		

* Made-to-order

RECOMMENDED OPERATING SPEEDS (RPM)

MATERIAL TYPE	PRODUCT DIAMETER				
	3mm	6mm	10mm	12mm	16mm
Steel	60000-90000	45000-60000	30000-40000	22500-30000	18000-24000
Tempered steel	60000-90000	30000-45000	19000-30000	15000-22500	12000-18000
Stainless steel	60000-90000	30000-45000	19000-30000	15000-22500	12000-18000
Casting	45000-90000	22500-60000	15000-40000	11000-30000	9000-24000
Titanium	60000-90000	30000-45000	19000-30000	15000-22500	12000-18000
Nickel	60000-90000	30000-45000	19000-30000	15000-22500	12000-18000
Copper & copper alloys	45000-90000	22500-60000	15000-40000	11000-30000	9000-24000
Aluminium	30000-90000	15000-70000	10000-50000	7000-38000	6000-30000
Plastics	30000-90000	15000-70000	10000-50000	7000-38000	6000-30000
Carbon or glass fibers	64000-117000	32000-59000	19000-35000	16000-30000	12000-22000

Recommended speeds are for standard shank length of 45mm, maximum overhang 10mm. Maximum recommended speed for extra long burrs is 15000 RPM.

RECOMENDATIONS FOR USE

- It may be necessary to adjust the rates shown to achieve optimum performance
- Running below the optimum speed will encourage chipping
- Harder materials or sticky metals such as, titanium, require slower speeds
- Running above optimum speed will cause tooth wear
- Smaller burrs require faster speeds
- Allowing the tool to become too hot may cause the braze to melt and detach the head of the shank
- Apply constant movement and light pressure when in use
- Do not sink the burr for more than one third of its periphery



NORTON NORBEVEL

New Norton **NorBevel-6** and **NorBevel-12** machines are a revolution in beveling and rounding metal!

Norton now offers two new machine ranges, compact and ergonomic, electric and the pneumatic to make beveling and rounding metal easier, faster, more accurate and more cost effective. The NorBevel concept has been designed for heavy-duty beveling and radius work, beveling up to a depth of 12 mm.



FOR **BEVELLING**, NORBEVEL PROVIDES:

BETTER WORKING CONDITIONS

Lightweight and almost vibration-free. The chips are large enough to immediately drop to the ground. No hazardous dust particles and/or combustion gases are released.

A MORE CONSISTENT AND ACCURATE ANGLE

NorBevel-6 and NorBevel-12 machines provide a more consistent and accurate angle to the metal for a stronger welded joint.

A MACHINE QUALITY FINISH WITHOUT CONTAMINATION

A better quality weld joint is created through reduced encapsulation of impurities in the weld, as NorBevel does not contaminate the metal.

SPEED AND FLEXIBILITY

Approximately 1.2m of beveling can be done in one minute. In a matter of seconds the machine can be adjusted and the bevel heads replaced.

NO FINISHING AND NO DISCOLORATION

A perfect end result straight away, without finishing. Discoloration is prevented through reduced-sparking that adds hardly any heat to the material.

FOR **ROUNDING**, NORBEVEL PROVIDES:

UNIFORM QUALITY

A larger bonding surface is created for paint and coatings due to the uniform radius. Cable feed glands are no longer required to prevent chafing when feeding through cables, wiring and/or piping.

A QUALITY FINISH

Only with NorBevel you can quickly achieve high levels of constant quality when rounding metal.

SPEED AND FLEXIBILITY

Rounding small openings from a diameter of 18 mm is easy due to the compact and lightweight machine design. Rounding metal now has an unprecedented degree of flexibility.



NORTON NORBEVEL-12 RANGE

The NorBevel 12 models have been designed for heavy duty beveling and radius work, beveling up to a depth of 12 mm. Both the EBA-12 and ABA-12 models have powerful motors, adjustable heads for adapting beveling depth, and come in a convenient travel case with adaptor. The electric version, EBA-12 has a variable speed switch for greater control.

NORBEVEL EBA-12 ELECTRIC

- Bevel radius: R2, R3, R4, R5, R6, R8
- Bevel angle: 15°, 22,5°, 30°, 37,5°, 45°, 60°
- Electric Motor: 1.53kw
- Voltage: 230V / 120V
- Speed: 10.500 rpm
- Weight: 4,5kg

MAX. BEVEL DEPTH	MIN. PIPE / OPENING DIA	ART NO.	PRICE
12mm	41mm	66261107700	€000.00



Bevel head with depth adjustment



Variable speed setting



Supplied in a convenient case

NORBEVEL ABA-12 PNEUMATIC

- Bevel radius: R2, R3, R4, R5, R6, R8
- Bevel angle: 15°, 22,5°, 30°, 37,5°, 45°, 60°
- Power: 2 PK / 1,48kw
- Air pressure: 6 bar
- Air consumption: 1100 ltr / min
- Speed: 10.000 rpm
- Weight: 5,66 kg

MAX. BEVEL DEPTH	MIN. PIPE / OPENING DIA	ART NO.	PRICE
12mm	41mm	66261107706	€000.00

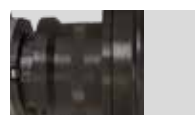

Bevel head with depth adjustment



Safety lever



Supplied in a convenient case

HEADS FOR NORBEVEL-12 (ELECTRIC AND PNEUMATIC)

MAX DEPTH (mm)	RADIUS / ANGLE	PK QTY	LASER-CUT STEEL & STAINLESS STEEL		STEEL		ALUMINIUM, PLASTIC, BRASS & SOFT METALS	
			Part No.	Price	Part No.	Price	Part No.	Price
8mm 	R2	1	66261136479	£000.00	66261107707	£000.00	66261113318	£000.00
	R3	1	66261136480	£000.00	66261107799	£000.00	66261113319	£000.00
	R4	1	-	-	66261107801	£000.00	66261113320	£000.00
	R5	1	66261152485	£000.00	-	-	-	-
	R8	1	66261152489	£000.00	-	-	66261152484	£000.00
8mm 	30°	1	66261146205	£000.00	66261107805	£000.00	66261113321	£000.00
	37,5°	1	-	-	66261107806	£000.00	-	-
	45°	1	66261136503	£000.00	66261107809	£000.00	66261113323	£000.00
	15°	1	-	-	-	-	-	-
12mm 	22,5°	1	-	-	66261107840	£000.00	-	-
	30°	1	66261146212	£000.00	66261107841	£000.00	66261146169	£000.00
	37,5°	1	-	-	66261107843	£000.00	-	-
	45°	1	66261146216	£000.00	66261107844	£000.00	66261146171	£000.00
	60°	1	-	-	66261107845	£000.00	-	-

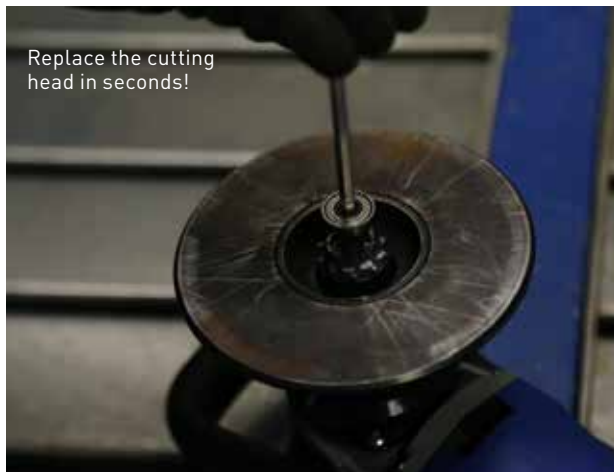

Recommended maximum cut depth is 4mm per pass



NORTON NORBEVEL- 6 RANGE

For lighter bevelling and rounding to a depth of 6 mm, the NorBevel-6 machines are compact, maneuverable, and available in two super light weight models, with electric and pneumatic motors. The Premium version can be used for more precise depth adjustment of 0.1 mm. Spindle lock for a lighter and quicker change of NorBevel heads, only one allen key is required.

NORBEVEL EBI-6 **+++++** ELECTRIC PREMIUM

- Bevel radius: R2, R3, R4
- Bevel angle: 15°, 22,5°, 30°, 37,5°, 45°, 60°
- Electric Motor: 500 W
- Voltage: 230V / 120V
- Speed: 11.000 rpm
- Weight: 2.0kg

MAX. BEVEL DEPTH	MIN. PIPE / OPENING DIA	ART NO.	PRICE
6mm	22mm	66261126777	€000.00

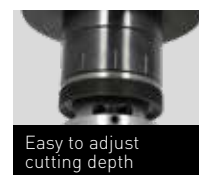

NORBEVEL EBI-6 **+++** ELECTRIC

- Bevel radius: R2, R3, R4
- Bevel angle: 15°, 22,5°, 30°, 37,5°, 45°, 60°
- Electric Motor: 500 W
- Voltage: 230V / 120V
- Speed: 11.000 rpm
- Weight: 1.6kg

MAX. BEVEL DEPTH	MIN. PIPE / OPENING DIA	ART NO.	PRICE
6mm	22mm	66261107846	€000.00



NORBEVEL ABIS-6 **+++++** PNEUMATIC PREMIUM

- Bevel radius: R2, R3, R4
- Bevel angle: 15°, 22,5°, 30°, 37,5°, 45°, 60°
- Power: 8 PK / 0.38 kw
- Air pressure: 6 bar
- Air consumption: 310 ltr / min
- Speed: 25.000 rpm
- Weight: 1,1 kg



MAX. BEVEL DEPTH	MIN. PIPE / OPENING DIA	ART NO.	PRICE
6mm	22mm	66261129888	£000.00



NORBEVEL EBI-6 **+++** PNEUMATIC

- Bevel radius: R2, R3, R4
- Bevel angle: 15°, 22,5°, 30°, 37,5°, 45°, 60°
- Power: 8 PK / 0.38 kw
- Air pressure: 6 bar
- Air consumption: 310 ltr / min
- Speed: 25.000 rpm
- Weight: 0.8 kg



MAX. BEVEL DEPTH	MIN. PIPE / OPENING DIA	ART NO.	PRICE
6mm	22mm	66261107847	£000.00

HEADS FOR NORBEVEL-06 (ELECTRIC AND PNEUMATIC)

MAX DEPTH (mm)	RADIUS / ANGLE	PK QTY	LASER-CUT STEEL & STAINLESS STEEL	STEEL	ALUMINIUM, PLASTIC, BRASS & SOFT METALS			
 6mm	R2	1	66261136486	£000.00	66261107851	£000.00	66261113306	£000.00
	R3	1	66261136502	£000.00	66261107852	£000.00	66261113309	£000.00
	R4	1	66261146174	£000.00	66261107853	£000.00	66261113310	£000.00
 6mm	30°	1	66261146179	£000.00	66261107856	£000.00	66261113311	£000.00
	45°	1	66261136504	£000.00	66261107858	£000.00	66261113312	£000.00
	60°	1	-	-	66261107859	£000.00	-	-



Recommended maximum cut depth is 4mm per pass



STEEL WOOL

For cleaning a variety of materials and highlighting and rubbing wood. Washable and reusable. Won't rust, shred or splinter. Compatible with water based finishes. Synthetic Steel Wool is one of top NORTON quality items.

STANDARD **++++**

- Made from strands of ultra-fine steel filaments
- For use on wood, paint, metal, stone, marble & glass
- Can be used with a chemical stripper
- Ideal for cleaning & fine finishing



WEIGHT	GRADE	PK QTY	ARTICLE NO.	PRICE
1kg	0000	12	63642593149	£000.00
1kg	000	12	63642593151	£000.00
1kg	00	12	63642593153	£000.00
1kg	0	12	63642593154	£000.00



SAINT-GOBAIN ABRASIVES NV/SA
INDUSTRIELAAN 129
1070 ANDERLECHT
BRUSSELS
BELGIUM
TEL: +32 2 267 21 00
FAX: +32 2 267 84 24

SAINT-GOBAIN ABRASIVES, S.R.O.
POČERNICKÁ 272/96, MALEŠICE
108 00 PRAHA 10
CZECH REPUBLIC
TEL: +420 255 719 326
FAX: +420 255 719 321

SAINT-GOBAIN ABRASIVES A/S
ROBERT JACOBSENS VEJ 62A
2300 KØBENHAVN S
DENMARK
TEL: +45 4675 5244

PO BOX 643706
FORTUNE TOWER OFFICE 2106
JLT BLOCK C
(NEXT TO METRO STATION)
JUMEIRA LAKE TOWER, DUBAI
UNITED ARAB EMIRATES
TEL: +971 4 431 5154
FAX: +971 4 431 5434

SAINT-GOBAIN ABRASIFS
RUE DE L'AMBASSADEUR - B.P.8
78 702 CONFLANS CEDEX
FRANCE
TEL: +33 (0)1 34 90 40 00
FAX: +33 (0)1 39 19 89 56

SAINT-GOBAIN ABRASIVES GMBH
BIRKENSTRASSE 45-49
D-50389 WESSELING
GERMANY
TEL: +49 (0) 2236 703-1
+49 (0) 2236 8996-0
+49 (0) 2236 8911-0
FAX: +49 (0) 2236 703-367
+49 (0) 2236 8996-10
+49 (0) 2236 8911-30
FÜR DEN FACHHANDEL ÖSTERREICH
TEL: +43 (00) 662 430 076

SAINT-GOBAIN ABRASIVES KFT.
1225 BUDAPEST
BÁNYALÉG U. 60/B.
HUNGARY
TEL: +36 1 371 22 50
FAX: +36 1 371 22 55

SAINT-GOBAIN ABRASIVI S.P.A
VIA PER CESANO BOSCONI 4
I-20094 CORSICO MILANO
ITALY
TEL: +39 02 44 851
FAX: +39 02 44 78 266

SAINT-GOBAIN ABRASIVES S.A.
190 RUE J.F. KENNEDY
L-4930 BASCHARAGE
GRAND DUCHE DE LUXEMBOURG
TEL: +352 50 401 1
FAX: +352 50 16 33
NO. VERT (FRANCE) 0800 906 903

SAINT-GOBAIN ABRASIFS, S.A.
2 ALLÉE DES FIGUIERS
AIN SEBAA - CASABLANCA
MOROCCO
TEL: +212 5 22 66 57 31
FAX: +212 5 22 35 09 65

SAINT-GOBAIN ABRASIVES BV
GROENLOSEWEG 28
7151 HW EIBERGEN
P.O. BOX 10
7150 AA EIBERGEN
THE NETHERLANDS
TEL: +31 545 466466
FAX: +31 545 474605

SAINT-GOBAIN ABRASIVES AS
KARIHAUGVEIEN 89
1086 OSLO
NORWAY
TEL: +47 63 87 06 00
FAX: +47 63 87 06 01

SAINT-GOBAIN HPM POLSKA SP. Z O.O.
UL. NORTON 1
62-600 KOŁO
POLAND
TEL: +48 63 26 17 100
FAX: +48 63 27 20 401

SAINT-GOBAIN ABRASIVOS, L. DA
ZONA INDUSTRIAL DA MAIA
I-SECTOR VIII, NO. 122
APARTADO 6050
4476 - 908 MAIA
PORTUGAL
TEL: +351 229 437 940
FAX: +351 229 437 949

**SAINT-GOBAIN GLASS,
BUSINESS UNIT ABRASIVI
PUNCT DE LUCRU:**
LOC.VETIS, JUD. SATU MARE
447355, STR. CAREIULUI 11,
PARC INDUSTRIAL RENOVATIO
ROMANIA
TEL: +40 261 839 709
FAX: +40 261 839 710

SG HPM RUS
58, F. ENGELS STR.
STROENIE 2
105082 MOSCOW
RUSSIA
TEL: +74 955 408 355
FAX: +74 959 373 224

SAINT-GOBAIN ABRASIVES (PTY) LTD
2 MONTEER ROAD
ISANDO 1600
P.O. BOX 67
SOUTH AFRICA
TEL: +27 11 961 2000
FAX: +27 11 961 2184/5

SAINT-GOBAIN ABRASIVOS, S.A.
CTRA. DE GUIPÚZCOA, KM. 7,5
E-31195 BERRIOPLANO (NAVARRA)
SPAIN
TEL: +34 948 306 000
FAX: +34 948 306 042

SAINT-GOBAIN ABRASIVES AB
BOX 495
SE-191 24 SOLLENTUNA
SWEDEN
TEL: +46 8 580 881 00
FAX: +46 8 580 881 01

SAINT-GOBAIN INOVATIF MALZEMELER VE
AŞINDIRICI SAN. TIC. A.Ş.
GOLD PLAZA, ALTAY ÇEŞME MAHALLESİ,
ÖZ SOKAK, NO:19/16
34843 MALTEPE-ISTANBUL ,
TURKEY
TEL: 0090-216-217 12 50
FAX: 0090-216-442 40 74

SAINT-GOBAIN ABRASIVES
DOXEY RD
STAFFORD
ST16 1EA
UNITED KINGDOM
TEL: +44 1785 222 000
FAX: +44 1785 213 487



Saint-Gobain Abrasifs
European Headquarters
Rue de l'Ambassadeur - B.P.8
78 702 Conflans Cedex
France

Tel: +33 (0)1 34 90 40 00
Fax: +33 (0)1 39 19 89 56

www.nortonabrasives.com
www.youtube.com/NortonAbrasivesEMEA

Norton is a registered trademark of Saint-Gobain Abrasives.
Form #????



ABRASIVE SOLUTIONS INDUSTRIAL APPLICATIONS

2019