

Data sheet | Item number: 207-1331

Gelbox; for cables; Branch; with gel; 221, 2x73 Series; max. 4 mm² connectors; without splicing connectors; Size 1; gray



www.wago.com/207-1331



Color: 

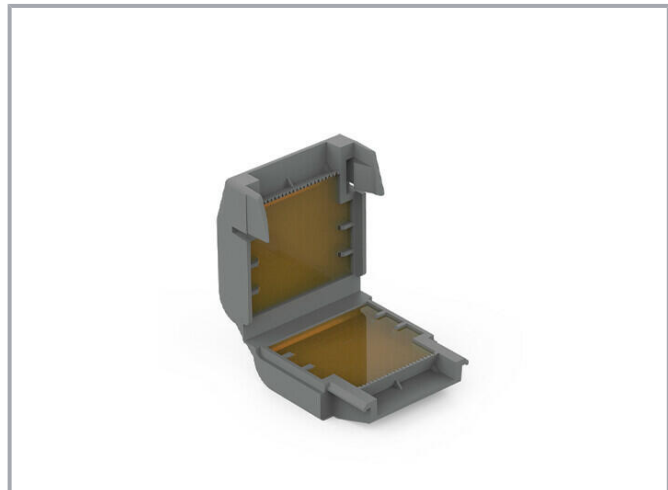

Item description

Note on Packaging Unit (PU) and Subpackaging Unit (SPU):

If you order a full PU, you will receive our eco-friendly, sustainable cardboard blisters packed in a shelf-ready box.

If you order a quantity smaller than a full PU, you will receive the eco-friendly, sustainable cardboard blisters without a shelf-ready box.

Subject to changes. Please also observe the further product documentation!

WAGO Private Limited
NH No. 8, Block No. 94 Vadsala,
Block No. 1187 Varnama, Village Varnama / Vadsala
Ta. & Distt. Vadodara, Vadodara, Gujarat-391243
Phone: +91-265-6812100 | Email: info.india@wago.com

Do you have any questions about our products?
We are always happy to take your call at +49 (571) 887-44222.



Please note the system description for the splicing connectors that can be used.

The Benefits for You:

- Easy, fast and safe to use
- Can be used immediately and accessed again later
- Silicon-free
- Label-free
- Suitable for indefinite storage
- The complete system consisting of Gelboxes and WAGO connectors has been VDE-tested and IPX8-certified.

Data

Connection data

Connection 1

Actuation type	Locking system
----------------	----------------

Physical data

Width	33.6 mm / 1.323 inch
Height	17.8 mm / 0.701 inch
Depth	32 mm / 1.26 inch

Mechanical data

Mounting type	Flying leads
Protection class	IPX8

Material data

Note on material data	Information on material data can be found here
Color	gray
Housing material	Polypropylene
Weight	12.7 g

Environmental requirements

Surrounding air temperature (operation)	-55 ... 85 °C
Surrounding air temperature (storage)	0 ... 40 °C

Subject to changes. Please also observe the further product documentation!

Commercial data

PU (SPU)	48 (4) Stück
Packaging type	BOX
Country of origin	IT
GTIN	4055143997799
Customs tariff number	85389099990

Approvals / Certificates

Country specific Approvals

Logo	Approval	Additional Approval Text	Certificate name
	VDE VDE Prüf- und Zertifizierungsinstitut	EN 60998	400051938

Downloads

Documentation

Bid Text

207-1331 doc - Datei	docx 20.8 kB	Download
207-1331 X81 - Datei	xml 3.7 kB	Download

System Description

System Description 207 Series Gel boxes	pdf 1.2 MB	Download
---	---------------	----------

Additional Information

Technical Section Technical explanations	pdf 2.2 MB	Download
---	---------------	----------

CAD/CAE-Data

CAD data

Subject to changes. Please also observe the further product documentation!

2D/3D Models 207-1331

[URL](#)

[Download](#)

CAE data

ZUKEN Portal 207-1331

[URL](#)

[Download](#)

Environmental Product Compliance

Compliance Search

Environmental Product Compliance 207-1331

[URL](#)

[Download](#)

Gelbox; for cables; Branch; with gel; 221, 2x73 Series; max. 4 mm² connectors; without splicing connectors; Size 1; gray

Installation Notes

Installation



Gelbox öffnen.



Place the wired connector in the Gelbox.

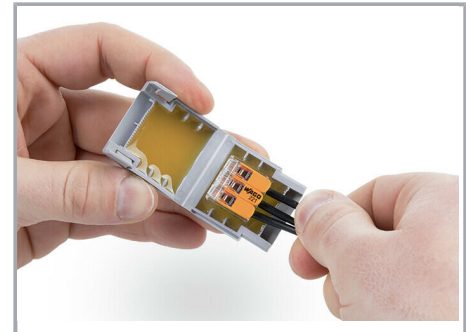

Place the wired connector in the Gelbox.

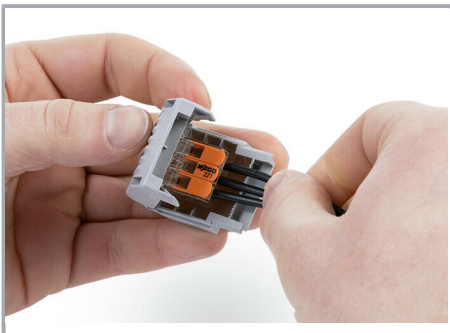

Close the Gelbox.

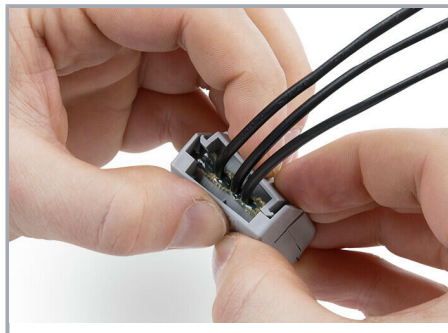

Close latch securely.

Subject to changes. Please also observe the further product documentation!

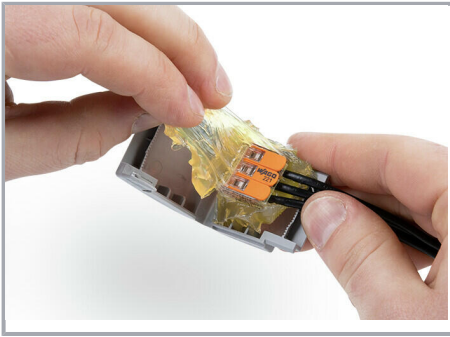

Re-accessible:

- Open the Gelbox.
- Remove the gel.
- Rewire with new components.



Lift the flap and pull the cover perforation forward.



Press in the perforation on the sides.

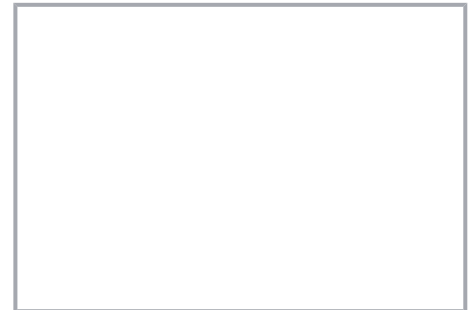

Tear off the cover from the perforation.

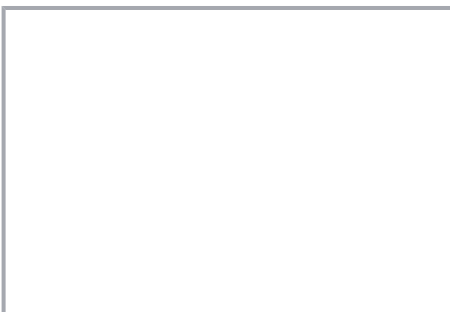

As a counter display: Bend the rear flap at the fold, straighten it and fix it in the cardboard cut-out

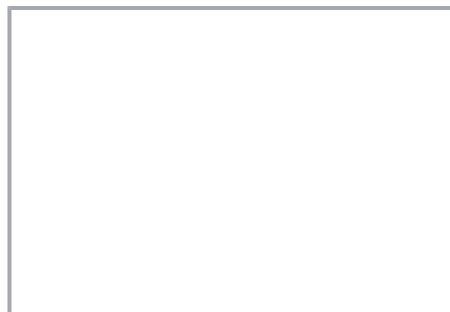

If the flap is not required, tear off from the perforation.

Subject to changes. Please also observe the further product documentation!