

- > Ø 10 ... 25 mm
- > Magnetic piston as standard
- > Conforming to ISO 6432
- > Corrosion resistant-
With buffer or adjustable cushioning
- > Nose mounting nut and piston rod supplied locknut as standard



Technical features

Medium:

Compressed air, filtered, lubricated or non-lubricated

Standard:

ISO 6432

Operation:

Double acting with magnetic piston and buffer or adjustable cushioning

Operating pressure:

1 ... 10 bar (14 ... 145 psi)

Cylinder diameters:

10, 12, 16, 20, 25 mm (buffer)
16, 20, 25 mm (adjustable cushioning)

Strokes:

See page below

Non-standard strokes:

up to 500 mm max. on request

Operating temperature:

-10 ... +80°C max. (+14 ... +176°F)

Air supply must be dry enough to avoid ice formation at temperatures below +2°C (+35°F).

Materials:

Barrel: stainless steel (austenitic)

End covers: clear anodised aluminium alloy

Piston rod: stainless steel (austenitic)

Buffer: PUR

Wiper: PUR

Seals: NBR

Technical data

Cylinder Ø (mm)	10	12	16	20	25
Port size	M5	M5	M5	G1/8	G1/8
Piston rod Ø (mm)	4	6	6	8	10
Piston rod thread	M4	M6	M6	M8	M10x1,25
Cushion length mm	—	—	16	19	19
Initial cushion volume (cm ³) *1)	—	—	2,4	4,4	7,2
Theoretical thrusts at 6 bar outstroke (N)	47,1	67,8	120	188	294
Theoretical thrusts at 6 bar instroke (N)	39,6	51	104	158	247
Air consumption at 6 bar outstroke (l/cm)	0,006	0,008	0,014	0,022	0,035
Air consumption at 6 bar instroke (l/cm)	0,005	0,006	0,013	0,019	0,028

*1) For cylinders with adjustable cushioning only

Standard strokes



with buffer cushioning

Cylinder Ø (mm)	Stroke length (mm)									
	10	25	40	50	80	100	125	160	200	250
10	•	•	•	•	•	•	—	—	—	—
12	•	•	•	•	•	•	•	•	•	—
16	•	•	•	•	•	•	•	•	•	•
20	•	•	•	•	•	•	•	•	•	•
25	•	•	•	•	•	•	•	•	•	•

with adjustable cushioning

Cylinder Ø (mm)	Stroke length (mm)									
	10	25	40	50	80	100	125	160	200	250
16	—	•	—	•	•	•	•	•	•	•
20	—	•	—	•	•	•	•	•	•	•
25	—	•	—	•	•	•	•	•	•	•

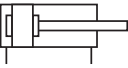
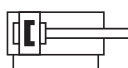
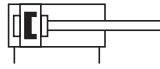
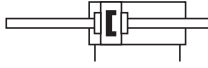
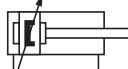
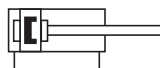
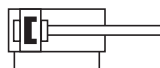
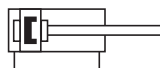
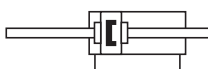
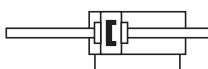
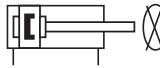
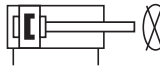
Cylinder variants

Symbol	Model Non-magnetic piston	Symbol	Model magnetic piston	Description	Dimensions
	TRM/8000 *1)		RM/8000/M	Standard cylinder with integral eye mounting	4
			RM/8000/MC	Cylinder with central rear port	5
			RM/8000/MF	Cylinder with flat rear cover	5
	RM/8000/IU TRM/8000/IU *1)		RM/8000/MU	Cylinder with extended piston rod piston rod extension 75 mm: *RM/8****/IU/stroke/75	4
			RM/8000/JM	Cylinder with double ended piston rod (Ø 16 to 25 mm)	4
			RM/8017/M	Cylinder Ø 16 mm with adjustable cushioning	4
			RM/8021/M	Cylinder Ø 20 mm with adjustable cushioning	4
			RM/8026/M	Cylinder Ø 25 mm with adjustable cushioning	4
			RM/8017/MU	Cylinder Ø 16 mm with adjustable cushioning and extended piston rod	4
			RM/8021/MU	Cylinder Ø 20 mm with adjustable cushioning and extended piston rod	4
			RM/8026/MU	Cylinder Ø 25 mm with adjustable cushioning and extended piston rod	4
			RM/8017/JM	Cylinder Ø 16 mm with double ended piston rod and adjustable cushioning	4
			RM/8021/JM	Cylinder Ø 20 mm with double ended piston rod and adjustable cushioning	4
			RM/8026/JM	Cylinder Ø 25 mm with double ended piston rod and adjustable cushioning	4
			RM/8000/N2	Cylinder with non-rotating piston rod (Ø 12 to 25 mm)	4
			RM/8000/L4	Cylinder Ø 12 to 25 mm with locking unit (PASSIVE). achieved by spring force on removal of the signal to the unit. Operating pressure for locking unit: 4 ... 10 bar	5

*1 Cylinder (Ø 16 ... 25 mm) with heat resistant seals 150°C max.

Option selector

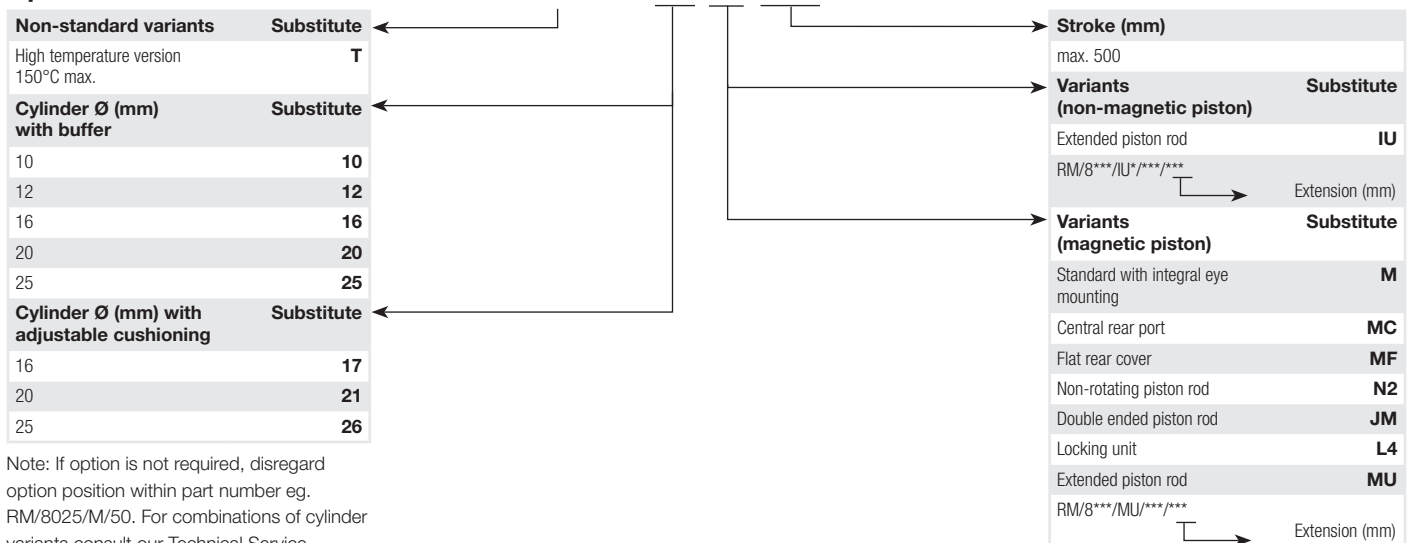

Note: If option is not required, disregard option position within part number eg. RM/8025/M/50. For combinations of cylinder variants consult our Technical Service.
Please note that heat resistant seals are not available for all variants. This options selector explains only the cylinder variants.
Additional variants/options are not possible.

Note: Please fill in only the numbers of digits required, e.g. RM/8025/M/50

Mountings

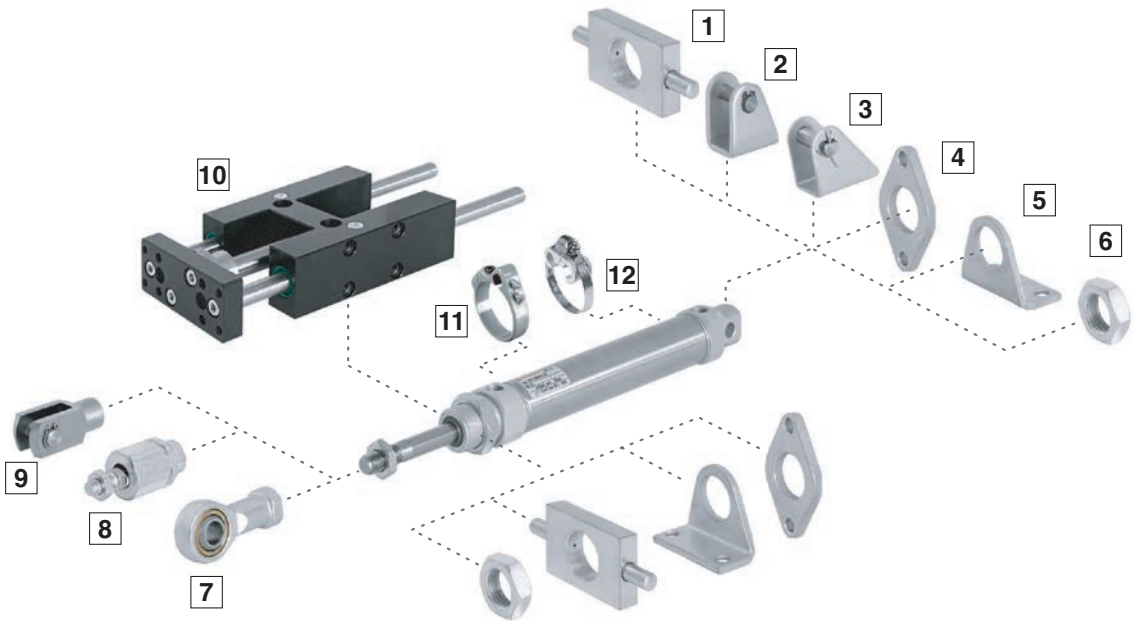

Cyl.	AK	B, G	C	F	FH
	8	4	5	9	1
Ø	Page 6	Page 6	Page 6	Page 6	Page 6
10	QM/8010/38	M/P19407	M/P19369	QM/8010/25	—
12	QM/8012/38	M/P19408	M/P19389	QM/8012/25	QM/8012/34
16	QM/8012/38	M/P19408	M/P19389	QM/8012/25	QM/8012/34
20	QM/8020/38	M/P19409	M/P19406	QM/8020/25	QM/8020/34
25	QM/8025/38	M/P19409	M/P19406	QM/8025/25	QM/8020/34
Cyl.	L	L2	N	UF	Guide block with roler bearing
	3	2	6	7	10
Ø	Page 6	Page 7	Page 7	Page 7	Page 8
10	QM/947	QM/8010/44	M/P1501/90	QM/8010/32	—
12	QM/8012/24	QM/8012/44	M/P13834	QM/8012/32	QM/8012/61/*
16	QM/8012/24	QM/8012/44	M/P13834	QM/8012/32	QM/8012/61/*
20	QM/8020/24	QM/8020/44	M/P13615	QM/8020/32	QM/8020/61/*
25	QM/8020/24	QM/8020/44	M/P13615	QM/8025/32	QM/8025/61/*
Cyl.	Switch mounting brackets >15 mm stroke	<15 mm stroke	Magnetically operated switches		
	11	12	Page 10 & 11		
Ø	Page 10	Page 10			
10	QM/33/012/22	QM/33/010/23			
12	QM/33/012/22	QM/33/016/23			
16	QM/33/016/22	QM/33/016/23			
20	QM/33/020/22	QM/33/020/23			
25	QM/33/025/22	QM/33/025/23			

* Insert standard stroke length: Ø 12 mm: 50, 100, 160, 200 and 250 mm; Ø 16 ... 25 mm: 50, 100, 160, 200, 250, 320, 400 and 500 mm., use nearest standard stroke.

Basic dimensions
RM/8000/M

Dimensions in mm
Projection/First angle

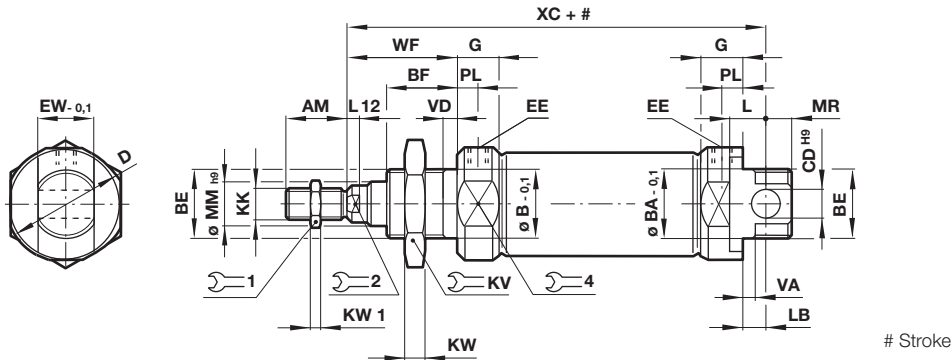

Ø	AM	Ø B/BA -0,1	BE	BF	Ø CD H9	Ø D	EE	EW -0,1	G	KK	⌀KV	KW	KW1	L	Model
10	12	12	M12x1,25	12	4	16,5	M5	7,9	9	M4	19	6	2	6	RM/8010/M/*
12	16	16	M16x1,5	17	6	21	M5	11,9	9,5	M6	22	5	3	9	RM/8012/M/*
16	16	16	M16x1,5	17	6	21	M5	11,9	9,5	M6	22	5	3	9	RM/8016/M/*
20	20	22	M22x1,5	20	8	30	G1/8	15,9	15	M8	27	8	4	12	RM/8020/M/*
25	22	22	M22x1,5	22	8	30	G1/8	15,9	15	M10x1,25	27	8	5	12	RM/8025/M/*
Ø	L12	LB	Ø MM H9	MR	PL	⌀1	⌀2	⌀4	WF	VA/VD	XC	at 0 mm	per 25 mm	Model	
10	-	2	4	8	5,5	7	-	14	16	1,5	64	0,034 kg	0,007 kg	RM/8010/M/*	
12	3	3	6	8	5,5	10	5	19	22	2	75	0,058 kg	0,011 kg	RM/8012/M/*	
16	3	4	6	7	5,5	10	5	19	22	2	82	0,070 kg	0,012 kg	RM/8016/M/*	
20	3	3	8	11	8	13	7	27	24	2	95	0,145 kg	0,018 kg	RM/8020/M/*	
25	4	7	10	9	8	17	9	27	28	2	104	0,200 kg	0,028 kg	RM/8025/M/*	

* Please insert standard stroke length.

Alternative variants
RM/8017/M, RM/8021/M, RM/8026/M –
Cylinder with adjustable cushioning

Ø	at 0 mm	per 25 mm	Model
16	0,070 kg	0,012 kg	RM/8017/M/*
20	0,145 kg	0,018 kg	RM/8021/M/*
25	0,195 kg	0,028 kg	RM/8026/M/*

* Please insert standard stroke length.

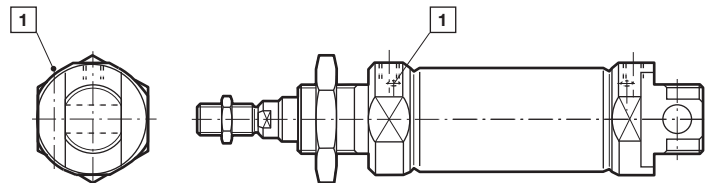

1 Cushion screw

RM/8000/N2 –
Cylinder with non-rotating piston rod

Ø	⌀1	Torque max.	at 0 mm	per 25 mm	Model
12	5	0,04 Nm	0,058 kg	0,011 kg	RM/8012/N2/*
16	5	0,04 Nm	0,070 kg	0,012 kg	RM/8016/N2/*
20	6	0,15 Nm	0,145 kg	0,018 kg	RM/8020/N2/*
25	8	0,25 Nm	0,200 kg	0,028 kg	RM/8025/N2/*

* Please insert standard stroke length.

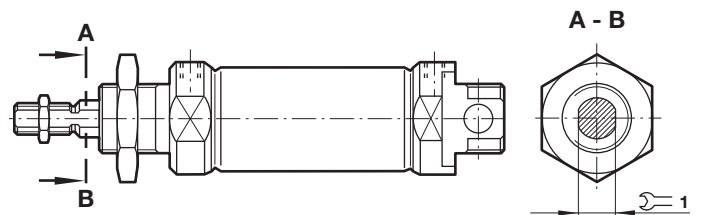

RM/8000/JM –
Cylinder with double ended piston rod

Ø	LB	ZM	at 0 mm	per 25 mm	Model
16	56	100	0,080 kg	0,017 kg	RM/8016/JM/*
20	68	116	0,165kg	0,028 kg	RM/8020/JM/*
25	69	125	0,250 kg	0,043 kg	RM/8025/JM/*

* Please insert standard stroke length.

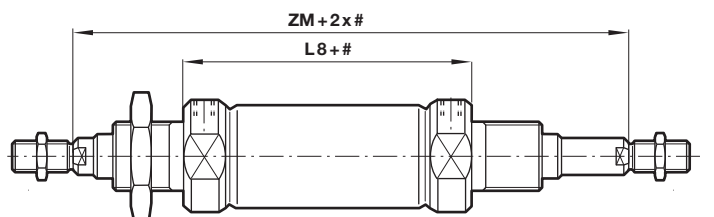

Stroke

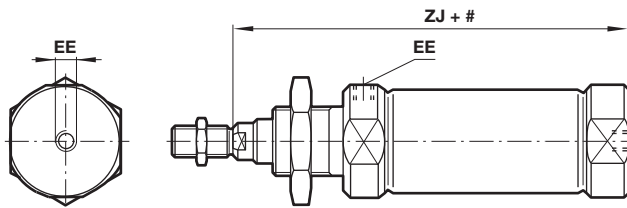
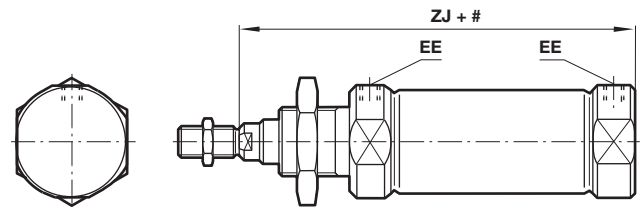
Alternative variants
**RM/8000/MC –
Cylinder with central rear port**

**RM/8000/MF –
Cylinder with flat rear cover**

 Dimensions in mm
Projection/First angle

Stroke

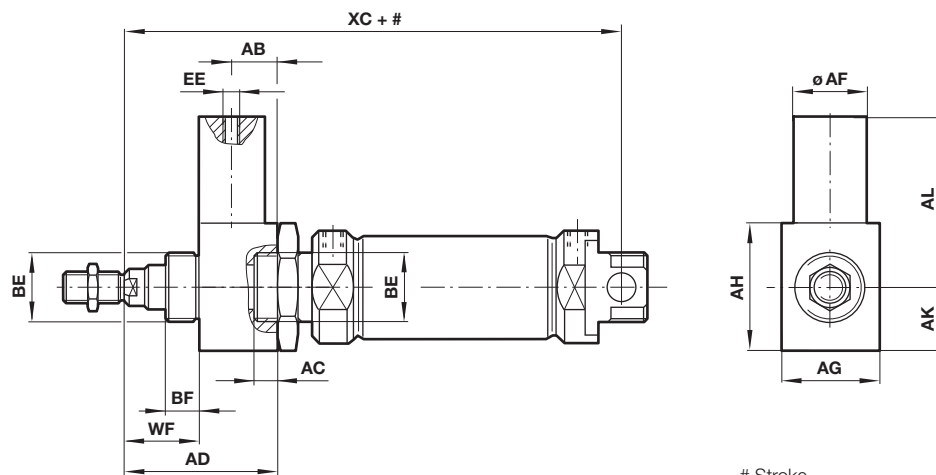
Ø	EE	ZJ	at 0 mm	per 25 mm	Model
10	M5	62	0,031 kg	0,007 kg	RM/8010/M*
12	M5	72	0,052 kg	0,011 kg	RM/8012/M*
16	M5	78	0,064 kg	0,012 kg	RM/8016/M*
20	G1/8	92	0,130 kg	0,018 kg	RM/8020/M*
25	G1/8	97	0,185 kg	0,028 kg	RM/8025/M*

* Please insert standard stroke length.

RM/8000/L4 – Cylinder with locking unit

Stroke

Ø	AB	AC	AD	Ø AF	AG	AH	AL	AK	Model
12	21	13	48,5	20	20	20	43,5	10	RM/8012/L4*
16	21	13	48,5	20	20	20	43,5	10	RM/8016/L4*
20	24	14	66	22	27	33	45,5	16,5	RM/8020/L4*
25	24	14	65	22	27	33	45,5	16,5	RM/8025/L4*
Ø	BE	BF	EE	WF	XC	Locking forces	at 0 mm	per 25 mm	Model
12	M16 x 1,5	12	M5	18,5	109	200 N	0,130 kg	0,011 kg	RM/8012/L4*
16	M16 x 1,5	12	M5	18,5	116	200 N	0,140 kg	0,012 kg	RM/8016/L4*
20	M22 x 1,5	23	M5	31	145	350 N	0,300 kg	0,018 kg	RM/8020/L4*
25	M22 x 1,5	23	M5	30	151,5	400 N	0,360 kg	0,028 kg	RM/8025/L4*

* Please insert standard stroke length.

Mountings

Piston rod swivel AK

Conforms to DIN ISO 8139

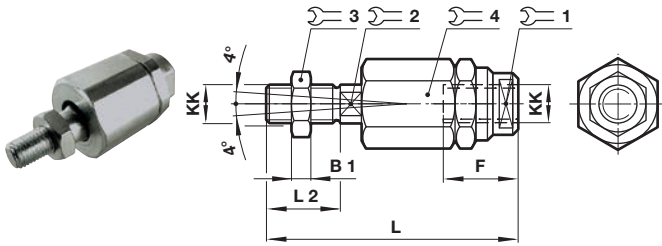

Ø	KK	B1	F	L	L2	1 2 3 4				kg	Model (AK)
						1	2	3	4		
10	M 4	2	12,5	33	8	11	3,2	7	11	0,01	QM/8010/38
12/16	M 6	3	14	39	12	7	5	10	13	0,02	QM/8012/38
20	M 8	4	18	55	16	10	7	13	17	0,05	QM/8020/38
25	M 10 x 1,25	5	26	73	20	19	12	17	30	0,2	QM/8025/38

Front or rear flange G and B

Dimensions in mm
Projection/First angle

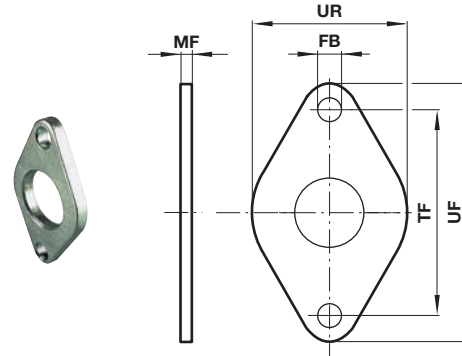

Ø	Ø FB	MF	TF	UF	UR	kg	Model (B, G)
10	4,5	3	30	40	22	0,02	MP19407
12/16	5,5	4	40	51	28	0,03	MP19408
20/25	6,6	5	50	63	38	0,05	MP19409

Foot C

Conforms to DIN ISO 6432

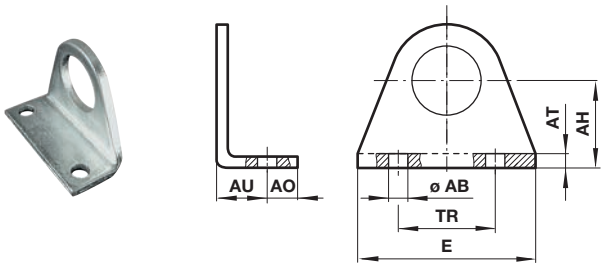

Ø	Ø AB	AH	AO	AT	AU	E	TR	kg	Model (C)
10	4,5	16	6	2	10	35	25	0,02	MP19369
12/16	5,5	20	6	3	13	43	32	0,03	MP19389
20/25	6,6	25	7,5	4	16	53	40	0,06	MP19406

Piston rod clevis F

Conforms to DIN ISO 8140

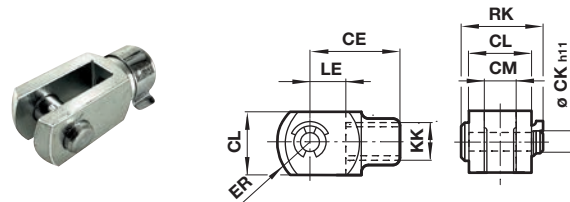

Ø	KK	CE	Ø CK h11	CL	CM	ER	LE	RK	kg	Model (F)
10	M4	16	4	8	4	6,5	8	11,5	0,01	QM/8010/25
12/16	M6	24	6	12	6	9,5	12	17,5	0,02	QM/8012/25
20	M8	32	8	16	8	13	16	22	0,06	QM/8020/25
25	M10 x1,25	40	10	20	10	16	20	28	0,10	QM/8025/25

Front or rear detachable trunnion FH

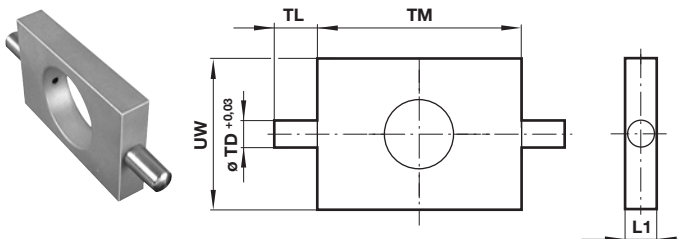

Ø	L1	Ø TD +0,03	TL	TM	UW	kg	Model (FH)
12/16	8	6	10	38	25	0,05	QM/8012/34
20/25	8	6	10	46	30	0,07	QM/8020/34

Rear hinge L

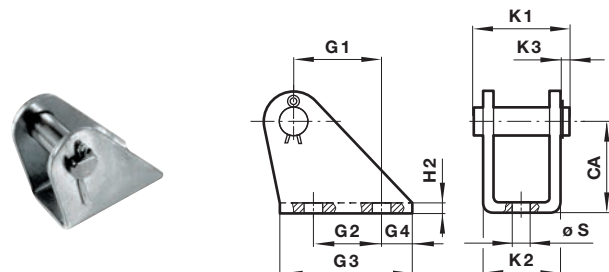

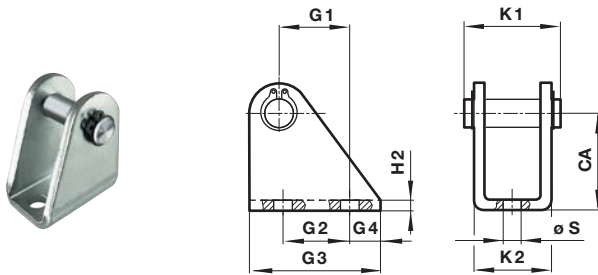

Ø	CA	G1	G2	G3	G4	H2	K1	K2	K3	Ø S	kg	Model (L)
10	12	6,5	-	15	6	1	13,5	10,5	2	4,8	0,01	QM/947
12/16	20	18,5	15	30	8	1,5	20	15	3	5,5	0,02	QM/8012/24
20/25	25	20	15	35	10	2	25	20,5	3	6,6	0,04	QM/8020/24

Rear hinge L2

Ø	CA	G1	G2	G3	G4	H2	K1	K2	Ø S	kg	Model (L2)
10	24	11	12,5	20	4	2,5	17,5	13	4,5	0,018	QM/8010/44
12/16	27	13	15	25	5	3	23	18	5,5	0,035	QM/8012/44
20/25	30	16	20	32	6	4	29,5	24	6,6	0,077	QM/8020/44

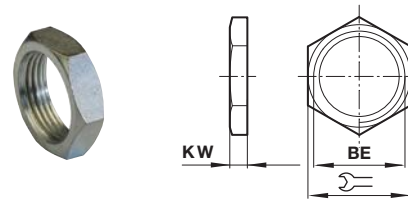
Nose nut N

 Dimensions in mm
Projection/First angle

Ø	BE		KW	kg	Model (N)
10	M12x1,25	19	6	0,01	M/P1501/90
12/16	M16x1,5	22	5	0,01	M/P13834
20/25	M22x1,5	27	8	0,02	M/P13615

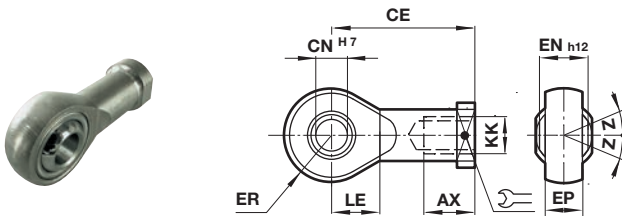
**Universal piston rod eye UF
Conforms to DIN ISO 8139**

Ø	KK	AX	CE	Ø CN H7	EN -0,1	ER	LE	Z	kg	Model (UF)
10	M4	14	27	5	8	8	10	5°	0,02	QM/8010/32
12/16	M6	14	30	6	9	9	11	5°	0,02	QM/8012/32
20	M8	16	36	8	12	11	13	5°	0,05	QM/8020/32
25	M10 x 1,25	25	42	10	14	14	15	5°	0,08	QM/8025/32

QM/8000/61 – Guide block

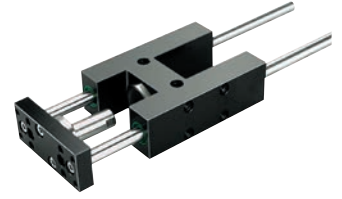
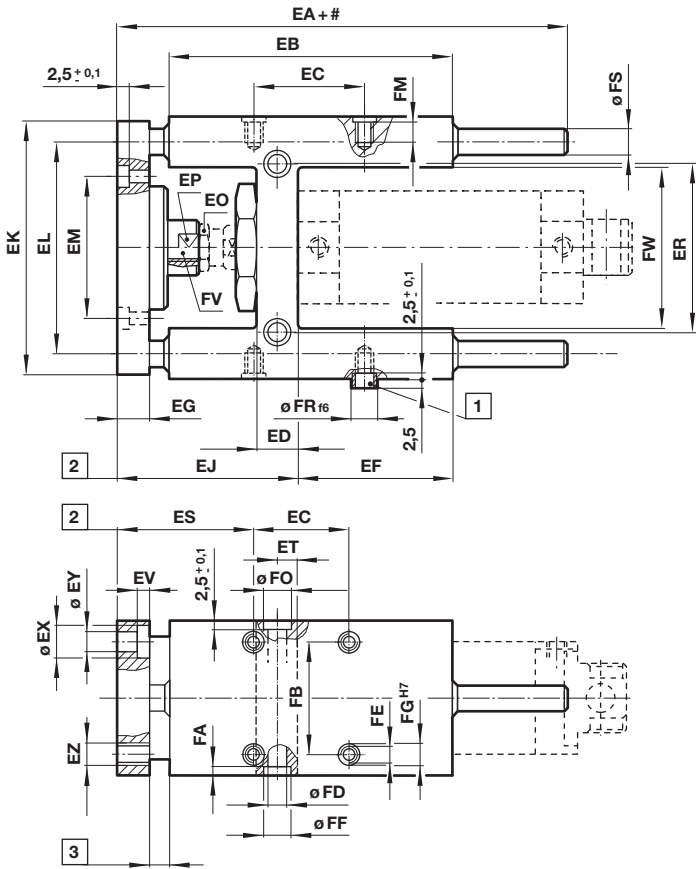

Dimensions in mm
Projection/First angle



- # Stroke
- 1 Centering sleeve
- 2 Adjustable
- 3 Safety zone

Ø	EA	EB	EC	ED	EF	EG	EJ	EK	EL	EM	EO	EP	ER	ES	ET	EV	EW	Ø EX	Ø EY	EZ	Model
12/16	132	75	32,5	16,5	37	10	76	63	46	24	10	8	24	65	6,5	4,6	27	8	4,5	M4	QM/8012/61
20	160	108	32,5	19	58	12	90	76	58	38	13	13	38	75	8,5	5,7	32	10	5,5	M5	QM/8020/61
25	160	108	32,5	19	58	12	90	76	58	38	17	13	38	75	8,5	5,7	32	10	5,5	M5	QM/8025/61
Ø	FA	FB	FC	Ø FD	FE	FF	Ø FG H7	FH	FJ	FK	FL	FM	Ø FO H7	FP	Ø FR f6	ØFS	FV	FW	kg at 0 mm	kg per 100 mm	Model
12/16	6	22	30	5,5	M 4	9	6	32	54	65	15	10	9	M5	6	8	M 6	27	0,40	0,04	QM/8012/61
20	7	23	34	6,6	M 6	11	9	40	68	79	20	14	9	M 6	9	10	M 8	37	0,65	0,06	QM/8020/61
25	7	23	34	6,6	M 6	11	9	40	68	79	20	14	9	M 6	9	10	M 10 x 1,25	37	0,65	0,06	QM/8025/61

Note: supplied complete with cylinder mounting screws and two centering sleeves

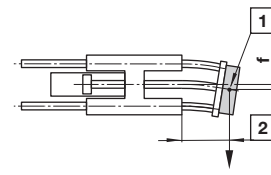
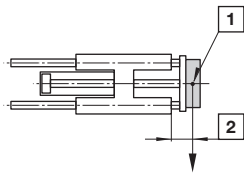
Maximum load for QM/8000/61

 Dimensions in mm
Projection/First angle

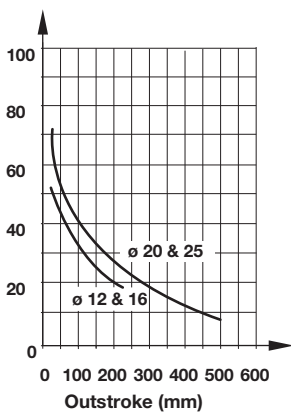
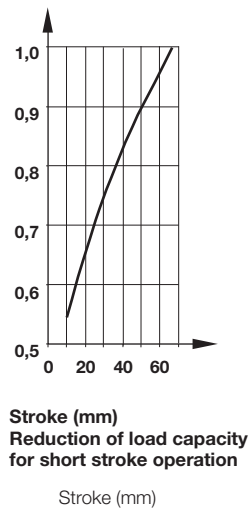
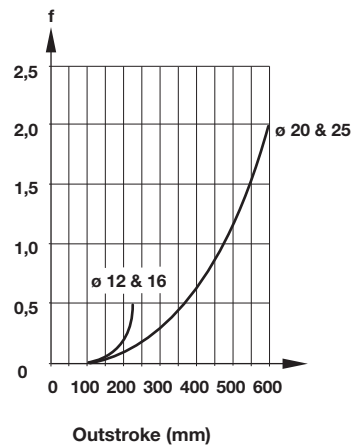
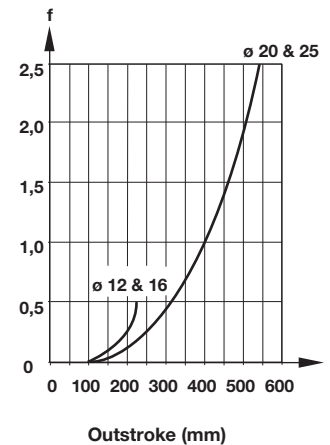

- 1 Centre of gravity load capacity
- 2 Outstroke

Maximum load capacity is dependent on the outstroke of a horizontally installed guide unit. In the case of short stroke operation, the load capacity figures taken from the diagram must be multiplied by the correction factor (diagram 2). In the curves of load capacity (diagram 1), the short stroke corrections have already been taken into account for an outstroke > 60 mm.

The total deflection of guide rods will be determined by the addition of that due to own weight (diagram 3) and that due to load capacity (diagram 4).

**Maximum load capacity depending on outstroke
(diagram 1)**
Load capacity

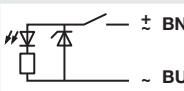
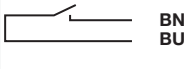
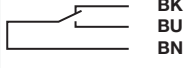
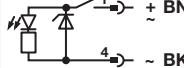
Correction factor

Deflection caused by own weight (diagram 3)
Deflection (mm)

Deflection caused by a load of 10 N (diagram 4)
Deflection (mm)

Technical data - Reed switches - additional informations see data sheet N/en 4.3.005

Symbol	Voltage (V a.c.) (V d.c.)	Current maximum (mA)	Function	Operating temperature (°C)	LED	Protection class	Plug	Cable length (m)	Cable type	Weight (g)	Model	
	10 ... 240	10 ... 170	180	Closer	-25 ... +80	•	IP66	—	2, 5 or 10	PVC 2 x 0,25	37	M/50/LSU/*V
	10 ... 240	10 ... 170	180	Closer	-25 ... +80	•	IP66	—	5	PUR 2 x 0,25	37	M/50/LSU/5U
	10 ... 240	10 ... 170	180	Closer	-25 ... +150	—	IP66	—	2	Silicon 2 x 0,25	37	TM/50/RAU/2S
	10 ... 240	10 ... 170	180	Changeover	-25 ... +80	—	IP66	—	5	PVC 3 x 0,25	37	M/50/RAC/5V
	10 ... 60	10 ... 60	180	Closer	-25 ... +80	•	IP66	M8 x 1	0,3	PVC 3 x 0,25	16	M/50/LSU/CP *1)

* Insert cable length; *1) Plug-in connector see page 11; Color code: BK = black, BN = brown, BU = blue

Drawings

M/50/LSU/*V, M/50/LSU/5U,
TM/50/RAU/2S
Cable length L = 2, 5 or 10 m

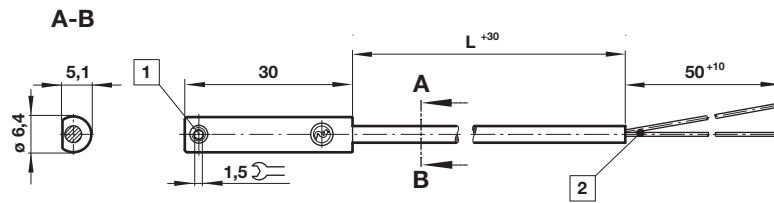

M/50/RAC/5V
Cable length L = 5 m

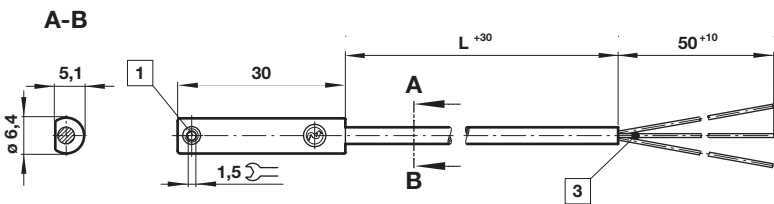

M/50/LSU/CP

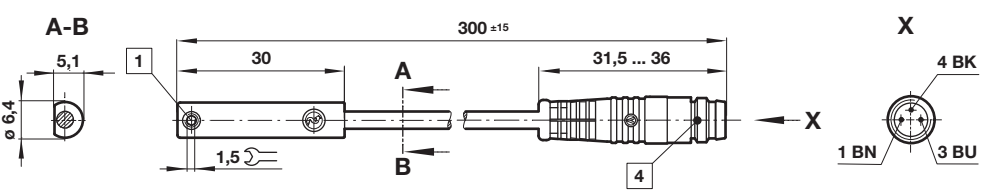

- 1 Fixing screw
- 2 + BN = brown; - BU = blue (output)
- 3 - BK = black; + BN = brown; - BU = blue
- 4 Plug M8 x 1, color code: BK = black; BN = brown; BU = blue

Dimensions in mm
Projection/First angle



Switch mounting brackets - Brackets > 15 mm stroke

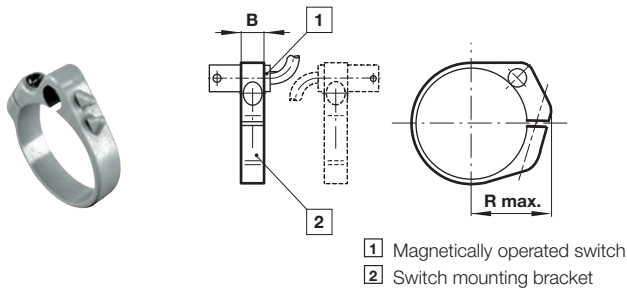

Switch mounting brackets - Brackets < 15 mm stroke

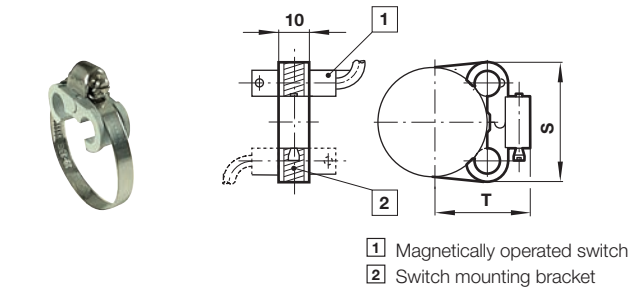

Ø	B	R max.	kg	Model
10	8	16	0,01	QM/33/010/22
12	8	18	0,01	QM/33/012/22
16	10	20	0,01	QM/33/016/22
20	10	22	0,01	QM/33/020/22
25	10	24	0,01	QM/33/025/22

Ø	S	T	kg	Model
10	27,5	19,5	0,01	QM/33/010/23
12	28,5	21,5	0,01	QM/33/016/23
16	29,5	23,5	0,01	QM/33/016/23
20	29,5	26	0,01	QM/33/020/23
25	31,5	28,5	0,01	QM/33/025/23

Technical data - Solid state - additional informations see data sheet N/en 4.3.007

Symbol	Voltage (V d.c.)	Current maximum (mA)	Function	Operating temperature (°C)	LED	Protection class	Plug	Cable length (m)	Cable type	Weight (g)	Model
	10 ... 30	150	PNP	-40 ... +80	•	IP67	—	2, 5 or 10	PVC 3 x 0,12	37	M/50/EAP/*V
	10 ... 30	150	PNP	-40 ... +80	•	IP68	—	5	PUR 3 x 0,14	37	M/50/EAP/5U
	10 ... 30	150	PNP	-40 ... +80	•	IP67	M8 x 1	0,3	PVC 3 x 0,14	16	M/50/EAP/CP *1)
	10 ... 30	150	PNP	-40 ... +80	•	IP67	M12 x 1	0,3	PVC 3 x 0,14	16	M/50/EAP/CC *1)
	10 ... 30	150	NPN	-40 ... +80	•	IP67	—	2, 5 or 10	PVC 3 x 0,12	37	M/50/EAN/*V
	10 ... 30	150	Closer	-40 ... +80	•	IP67	M8 x 1	0,3	PVC 3 x 0,14	16	M/50/EAN/CP *1)

* Insert cable length; *1) Plug-in connector below; Color code: BK = black, BN = brown, BU = blue

Drawings

M/50/EAP/*V,
M/50/EAN/*V
Cable length L = 2, 5 or 10 m

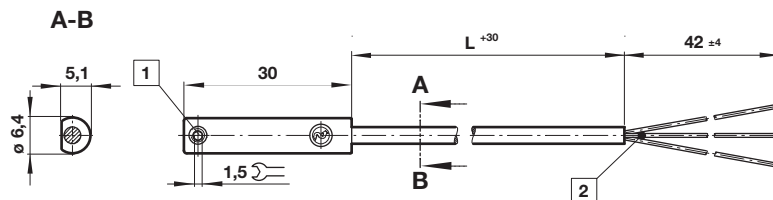

Dimensions in mm
Projection/First angle



M/50/EAP/CP,
M/50/EAN/CP

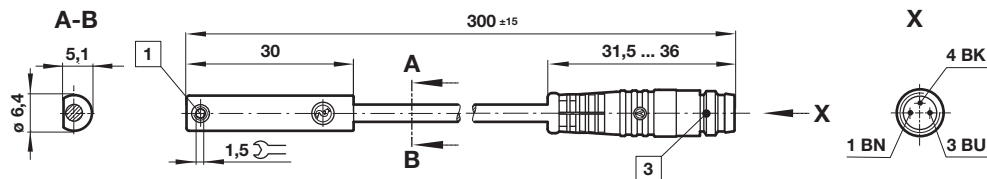

M/50/EAP/CC

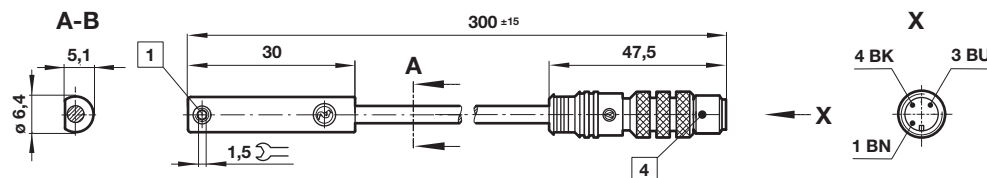

- 1 Fixing screw
- 2 Color code: BK = black; BN = brown; BU = blue
- 3 Plug M8 x 1
- 4 Plug M12 x 1

Accessories

Plug-in connector cable with nut



Outer cover	Cable length (m)	Weight (kg)	Connector	Connector
PVC 3 x 0,25	5 m	0,18	M8 x 1	M/P73001/5
PUR 3 x 0,25	5 m	0,18	M8 x 1	M/P73002/5
PUR 3 x 0,34	5 m	0,21	M12 x 1	M/P34594/5

Warning

These products are intended for use in industrial compressed air systems only. Do not use these products where pressures and temperatures can exceed those listed under »Technical features/data«.

Before using these products with fluids other than those specified, for non-industrial applications, life-support systems or other applications not within published specifications, consult IMI Precision Engineering, Norgren GmbH
Through misuse, age, or malfunction, components used in fluid power systems can fail in various modes.

The system designer is warned to consider the failure modes of all component parts used in fluid power systems and to provide adequate safeguards to prevent personal injury or damage to equipment in the event of such failure.

System designers must provide a warning to end users in the system instructional manual if protection against a failure mode cannot be adequately provided.

System designers and end users are cautioned to review specific warnings found in instruction sheets packed and shipped with these products.