

**Minimum Depth, Cost-effective Shielded Power Inlet Filter**

# SRB Series



UL Recognized  
CSA Certified  
VDE Approved\*



## SRB Series

- Smallest depth Corcom RFI filter available
- Complete shield
- Wide range of capacitor values
- Attenuates coupled EMI up to 300MHz
- Minimal to low leakage current versions are suitable for patient and non-patient contact medical equipment.
- Full range of mounting and termination options including unique vertical and horizontal orientation slide in mounts eliminate the need for mounting hardware

## Ordering Information

15 SRB S 1 - Q

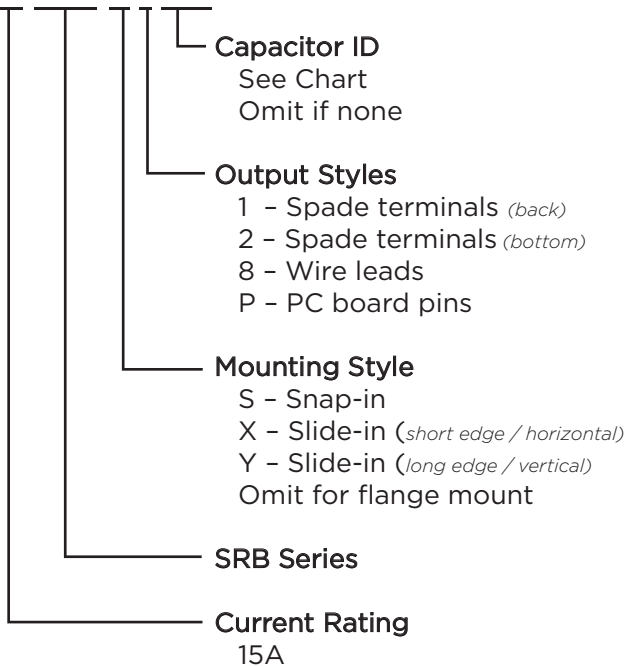

\*15A versions are tested by Underwriters Laboratories to US and Canadian requirements and are VDE approved at 10A, 250VAC

## Specifications

### Maximum leakage current each Line to Ground:

Capacitor ID / Value	@120 VAC	@250 VAC
Blank / None	2 µA	5 µA
Q / 33 pF	2.1 µA	3.65 µA
R / 100 pF	9.6 µA	16.6 µA
S / 220 pF	19.2 µA	33.2 µA
T / 330 pF	24.0 µA	41.5 µA
W / 470 pF	0.04 mA	0.07 mA
X / 1000 pF	0.07 mA	0.13 mA
Y / 2200 pF	0.16 mA	0.28 mA
Z / 3300 pF	0.24 mA	0.42 mA

### Hipot rating (one minute):

Line to Ground:	2250 VDC
Line to Line:	1450 VDC

### Rated Voltage (max.):

250 VAC

### Operating Frequency:

50/60 Hz

### Rated Current:

15A\*

### Operating Ambient Temperature Range

(at rated current  $I_r$ ): -10°C to +40°C

In an ambient temperature ( $T_a$ ) higher than +40°C the maximum operating current ( $I_o$ ) is calculated as follows:  $I_o = I_r \sqrt{(85-T_a)/45}$

## Capacitor Options

Capacitor ID	Capacitor Value
Q	33 pF
R	100 pF
S	220 pF
T	330 pF
W	470 pF
X	1000 pF
Y*	2200 pF
Z*	3300 pF

\*Not available in SRB8, SRBX or SRBY styles

**Minimum Depth, Cost-effective Shielded Power Inlet Filter** *(continued)*

# SRB Series

## Available Part Numbers

### Flange Mount

15SRB1	15SRB2	15SRBP	15SRB8
15SRB1-Q	15SRB2-Q	15SRBP-Q	15SRB8-Q
15SRB1-R	15SRB2-R	15SRBP-R	15SRB8-R
15SRB1-S	15SRB2-S	15SRBP-S	15SRB8-S
15SRB1-T	15SRB2-T	15SRBP-T	15SRB8-T
15SRB1-W	15SRB2-W	15SRBP-W	15SRB8-W
15SRB1-X	15SRB2-X	15SRBP-X	15SRB8-X
15SRB1-Y	15SRB2-Y	15SRBP-Y	
15SRB1-Z	15SRB2-Z	15SRBP-Z	

### Snap-In

### Slide-In

15SRBS1	15SRBS8	15SRBX8	15SRBY8
15SRBS1-Q	15SRBS8-Q	15SRBX8-Q	15SRBY8-Q
15SRBS1-R	15SRBS8-R	15SRBX8-R	15SRBY8-R
15SRBS1-S	15SRBS8-S	15SRBX8-S	15SRBY8-S
15SRBS1-T	15SRBS8-T	15SRBX8-T	15SRBY8-T
15SRBS1-W	15SRBS8-W	15SRBX8-W	15SRBY8-W
15SRBS1-X	15SRBS8-X	15SRBX8-X	15SRBY8-X
15SRBS1-Y			
15SRBS1-Z			

## Electrical Schematic

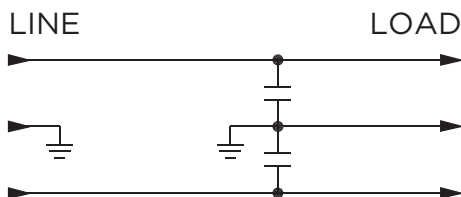

## Accessories

GA400: NEMA 5-15P to IEC 60320-1 C-13 line cord

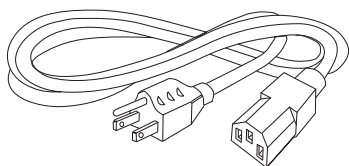

## Case Styles

### SRB1



Typical Dimensions:  
 Mounting holes (2): .132 [3.35] Dia. with .236 [5.99] Dia. x 90° countersink for #4 flathead screw  
 Line Inlet (1): IEC 60320-1 C14  
 Load Terminals (2): .250 [6.3] with .07 [1.8] Dia. hole  
 Ground Terminal (1): .250 [6.3] with .07 x .16 [1.8 x 3.8] slot

### SRB2



Typical Dimensions:  
 Mounting holes (2): .132 [3.35] Dia. with .236 [5.99] Dia. x 90° countersink for #4 flathead screw  
 Line Inlet (1): IEC 60320-1 C14  
 Load Terminals (2): .250 [6.3] with .07 [1.8] Dia. hole  
 Ground Terminal (1): .250 [6.3] with .07 x .16 [1.8 x 3.8] slot

### SRBP



Typical Dimensions:  
 Mounting holes (2): .132 [3.35] Dia. with .236 [5.99] Dia. x 90° countersink for #4 flathead screw  
 Line Inlet (1): IEC 60320-1 C14  
 PC board pins (3): .031 [0.7] square, ± .003 [.07]

### SRBS1



Typical Dimensions:  
 Line Inlet (1): IEC 60320-1 C14  
 Load Terminals (2): .250 [6.3] with .07 [1.8] Dia. hole  
 Ground Terminal (1): .250 [6.3] with .07 x .16 [1.8 x 3.8] slot

Minimum Depth, Cost-effective Shielded Power Inlet Filter *(continued)*

# SRB Series

## Case Styles *(continued)*

### SRB8



Typical Dimensions:  
 Mounting holes (2): .132 [3.35] Dia. with .236 [5.99] Dia. x 90° countersink for #4 flathead screw  
 Line Inlet (1): IEC 60320-1 C14  
 Wire Leads: 4.0 [101.6] Min., 18AWG, UL1015

### SRBS8



Typical Dimensions:  
 Line Inlet (1): IEC 60320-1 C14  
 Wire Leads: 4.0 [101.6] Min., 18AWG, UL1015

### SRBX8

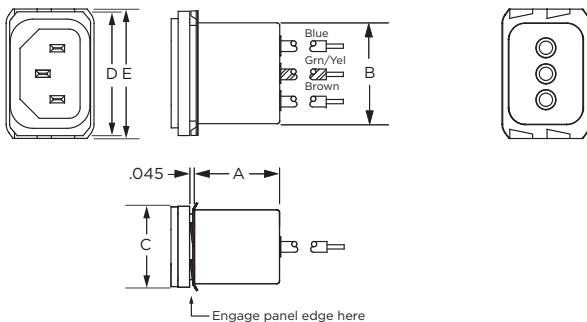

Typical Dimensions:  
 Line Inlet (1): IEC 60320-1 C14  
 Wire Leads: 4.0 [101.6] Min., 18AWG, UL1015

### SRBY8



Typical Dimensions:  
 Line Inlet (1): IEC 60320-1 C14  
 Wire Leads: 4.0 [101.6] Min., 18AWG, UL1015

## Case Dimensions

Part No.	A (max.)	B (max.)	C (max.)	D $\pm .015$ $\pm .38$	E (max.)
15SRB1	1.75 <i>44.45</i>	1.13 <i>28.70</i>	0.96 <i>24.38</i>	1.58 <i>40.00</i>	2.04 <i>51.76</i>
15SRB2	1.54 <i>39.12</i>	1.13 <i>28.70</i>	0.96 <i>24.38</i>	1.58 <i>40.00</i>	2.04 <i>51.76</i>
15SRBP	1.54 <i>39.12</i>	1.13 <i>28.70</i>	0.96 <i>24.38</i>	1.58 <i>40.00</i>	2.04 <i>21.76</i>
15SRBS1	1.75 <i>44.45</i>	1.13 <i>28.70</i>	0.96 <i>24.38</i>	1.19 <i>30.10</i>	1.41 <i>35.81</i>
15SRB8	0.95 <i>24.13</i>	1.13 <i>28.70</i>	0.96 <i>24.38</i>	1.58 <i>40.00</i>	2.04 <i>51.76</i>
15SRBS8	.95 <i>24.13</i>	1.13 <i>28.70</i>	0.96 <i>24.38</i>	1.19 <i>30.10</i>	1.41 <i>35.81</i>
15SRBX8	0.95 <i>24.1</i>	1.11 <i>28.2</i>	0.89 <i>22.61</i>	1.35* <i>34.29*</i>	1.41 <i>35.81</i>
15SRBY8	0.95 <i>24.1</i>	1.11 <i>28.2</i>	0.89 <i>22.61</i>	1.30* <i>33.02*</i>	1.36 <i>34.54</i>

\*max.

**Minimum Depth, Cost-effective Shielded Power Inlet Filter** *(continued)*

# SRB Series

## Recommended Panel Cutouts

### SRB1, SRB2, SRBP & SRB8

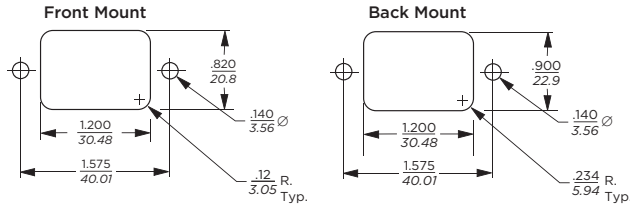

Tolerances  $\pm .005$  [0.13] unless otherwise noted  
 Note 1: SRB1 and SRB8 can be front or back mounted  
 Note 2: SRB2 and SRBP can be back mounted only

### SRBS



Panel Thickness	G Dim. $\pm .002$ [.05]
0.031 - 0.052 [0.79 - 1.32]	1.260 [32.00]
0.046 - 0.068 [1.17 - 1.73]	1.350 [34.29]

### SRBX



### SRBY



## PC Board Layout

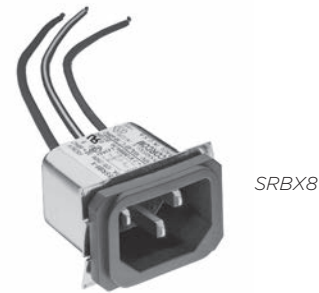
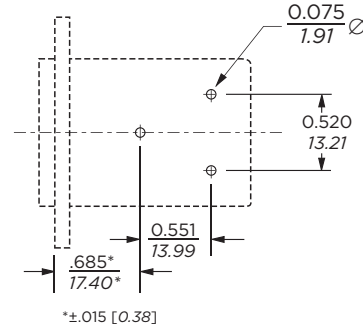

**Minimum Depth, Cost-effective Shielded Power Inlet Filter** *(continued)*

# SRB Series

## Performance Data

### Typical Insertion Loss

Measured in closed 50 Ohm system



### Minimum Insertion Loss

Measured in closed 50 Ohm system

Common Mode / Asymmetrical (Line to Ground)

Current Rating	Frequency – MHz					
	1	5	10	50	100	300
Q	-	-	-	-	-	20
R	-	-	-	3	6	22
S	-	-	1	6	17	19
T	-	-	2	13	13	19
W	-	2	4	18	13	20
X	-	5	9	25	10	17
Y	1	10	15	20	8	22
Z	2	14	18	17	7	15