



Think Automation and beyond...

# Flush Silhouette Switches LB/LBW Series 16mm LB Series Miniature Switches & Pilot Lights



# Stylish and Functional

IDEC's extensive range of LB/LBW series switches can be used for a wide range of applications.

## Flush Silhouette

### LB Series Flush Silhouette Switches

Slim 2mm-thick bezels for stylish panels.

### LBW Series Flush Silhouette Switches

Smart appearance with large surface for secure operation.



### Flush Silhouette

Projects only 2mm from the panel surface. For sleek and refined style.

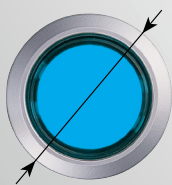

**LB Series Bezel**  
ø22/□22mm

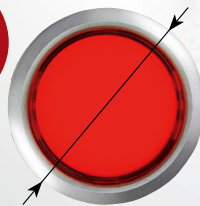

**LBW Series Bezel**  
ø26/□26mm

New LBW series with ø26/□26mm bezels. Large button surface for easy usability. Ideal for frequently used switches such as STOP and START. (Actual size)

## Miniature Switches and Pilot Lights

### ø16mm LB Series Miniature Switches and Pilot Lights

Short body for space-saving installation.

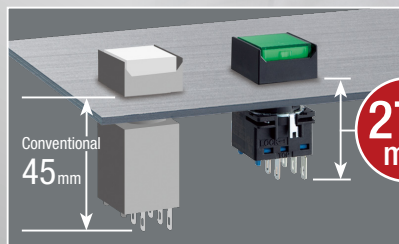

**27.9mm**

### Short Body

Depth of only 27.9mm behind panel. Reduces the size of machines and control panels.

Compact

## Flush Silhouette & Miniature Switches and Pilot Lights

### Removable Contact Block /Single Board Mounting

Removable contacts enable easy wiring / Single board mounting for space-saving installation.

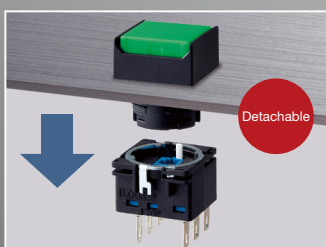

Detachable



For details on UP series **P.52**

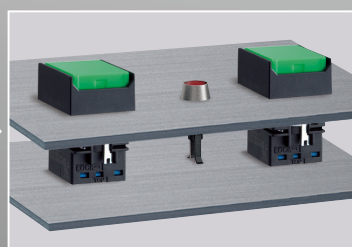

### Waterproof

Degree of protection: IP65



Detachable & Single Board

New UP series has the same depth as LB/LBW series. Mounts on the same panel. (Flush bezel: 34.9mm, standard bezel: 27.9mm)

Waterproof



## LB Series and LBW Series

For diverse applications



Flush silhouette switches and  $\varnothing 16\text{mm}$  miniature switches and pilot lights. Wide variety of switches to choose from.



New LBW series with large operator surface for easy usability.

# LB SERIES

## Flush Silhouette Switches

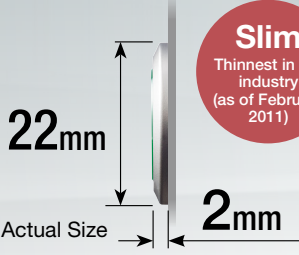

**Slim**  
Thinnest in the industry  
(as of February 2011)

Protection degree: IP65 (IEC 60529)

For sleek and refined style

\* Panel cutout (mm)



### Illuminated Pushbuttons

Illuminated pushbuttons with switch guard available



### Pushbuttons

Marking plates can be used with lens style pushbuttons



\*Does not light on.



Pushbuttons with switch guard available

Round  
ø18.2\*

Square  
□18.2\*

Rectangular  
18.2 x 24.2\*

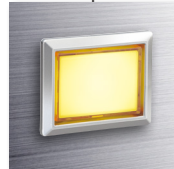
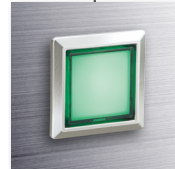

### Pilot Lights



### Dome Pilot Lights



### Selector Switches

2-position and 3-position selector switches. Maintained and other various spring return actions available.

\*Photo: lever operator (knob operator also available)

Illuminated selector switches available



Wave Key

**Key Selectors**  
ensure safety

Seven different keys to choose from. Key removable in desired positions.



### Buzzer

Protection degree: IP54  
Steady sound at 80 dB minimum (at 0.1m)



### Lever Switches

Degree of protection: IP67  
Up/down operation.  
2- and 3-positions available.  
For 3-position switches, maintained and return two-way actions available.

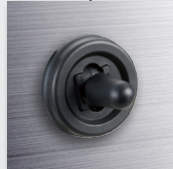

# LBW SERIES

## Flush Silhouette Switches



**Slim**  
Thinnest in the industry  
(as of May 2012)

Projects only 2mm from the panel. Removable contact blocks ideal for single board mounting.  $\varnothing 26/\square 26$  bezel size for easy operation.

For sleek and refined style



### Illuminated Pushbuttons

Illuminated pushbuttons with switch guard available



### Ring-illuminated Pushbuttons



### Pushbuttons

Marking plates can be used with lens style pushbuttons



\*Does not light on.



Pushbuttons with switch guard available

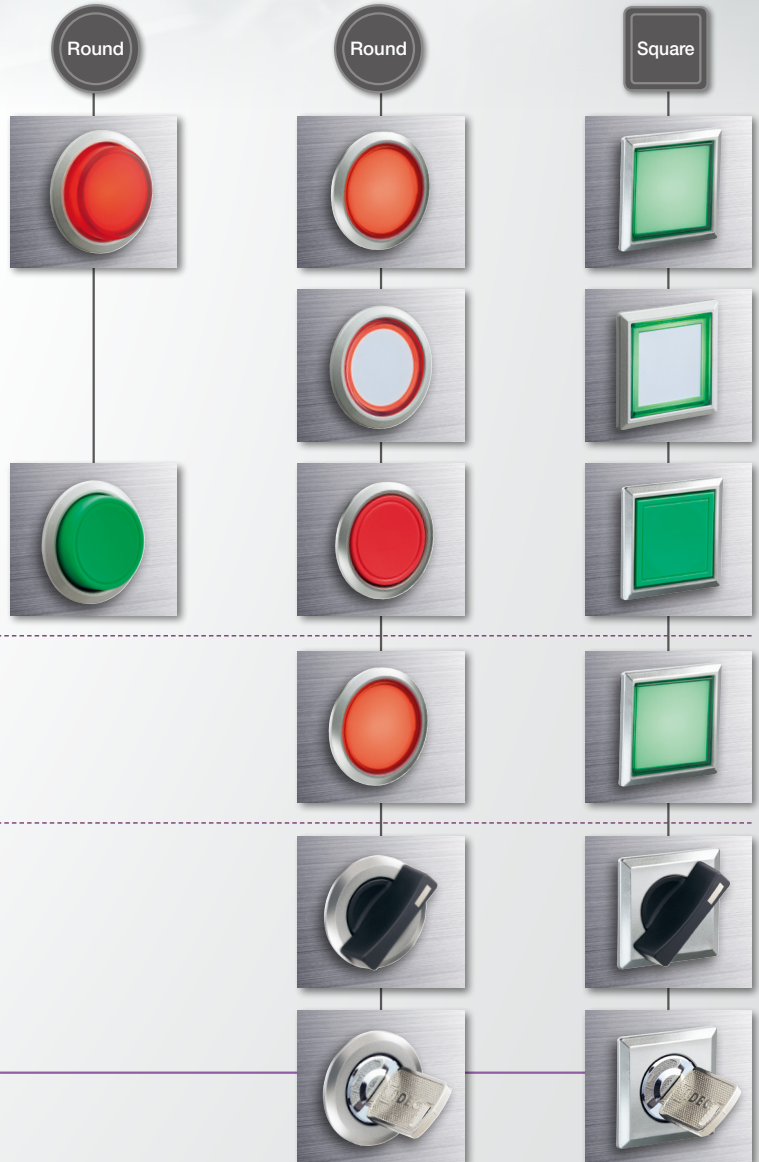

### Pilot Lights



### Selector Switches

2-position and 3-position selector switches. Maintained and spring return actions available.



Key Selectors ensure safety

Wave Key

Seven different keys to choose from. Key removable in desired positions.

Stylish Appearance with Advanced Functions

Operation status is easily visible due to illumination on the operator.



Illuminated Selector Switch (LB series only)



Switch guard prevents inadvertent switch operation

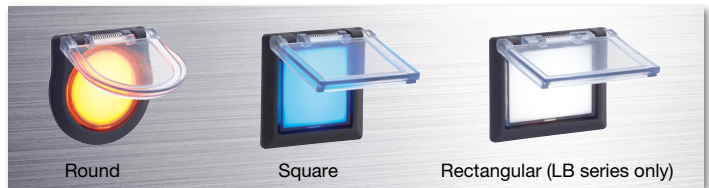

#### Illuminated Pushbutton Color Variations



#### Pushbutton Color Variations



#### Bezel Color Variations



#### Ring-Illuminated Pushbutton Color Variations

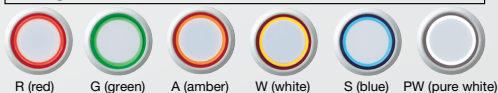

#### Ring-Illuminated Pushbutton Bezels



# Ø16mm LB SERIES

## Miniature Switches and Pilot Lights (Standard Bezel)

Panel depth of only 27.9mm.  
Removable contact blocks ideal for single board mounting.  
Protection degree: IP65 (IEC 60529)

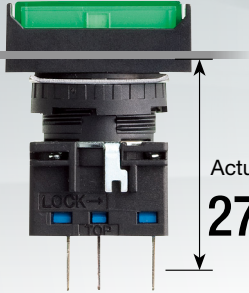

**Short**  
Shortest in the industry  
(as of February 2011)

Actual Size  
**27.9mm**

For space-saving installation



### Illuminated Pushbuttons



### Pushbuttons

Marking plates can be used with lens style pushbuttons  
  
\*Does not light on.

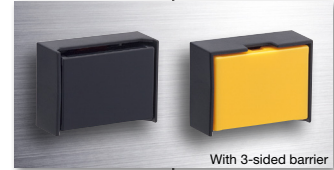

### Pilot Lights

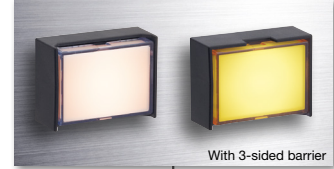

### Dome Pilot Lights



### Selector Switches

2- and 3-position selector switches. Maintained and other various spring return actions available.  
\*Photo: knob operator (lever operator also available)  
 Illuminated selector switches available



**Key Selectors**  
ensure safety

Wave Key

Seven different keys to choose from. Key removable in desired positions.

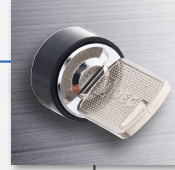

### Buzzers

Steady sound at 80 dB minimum (at 0.1m)  
IP54 tab terminals, PC board terminal, and IP40 solder terminals available.



### Lever Switches

Degree of protection: IP67  
Up/down operation.  
2- and 3-positions available.  
For 3-position switches, maintained and return two-way actions available.



Illuminated Pushbutton Color Variations



Pushbutton Color Variations







# Flush Silhouette Switches LB Series

# Flush Silhouette Switches LBW Series

## ø16mm LB Series Switches and Pilot Lights

**Flush bezel projects only 2 mm from front of panel. Standard bezel with only a panel depth of 27.9 mm. Removable contact blocks ideal for single board mounting.**

- Pushbuttons, selector switches, and key selector switches with up to 3PDT contacts.
- Wave keys are used for key selector switches to prevent duplication of keys. Six different keys are available besides standard key.
- Black or metallic flush bezels available.
- Bright and clear illumination surface. LED illumination.
- Gold-clad, cross-bar contact, or high-capacity silver contacts.
- Protection degree: IP65 (IEC60529)

Applicable Standards	Mark	File No. or Organization
UL508		UL Recognition No.E55996
CSA 22.2 No.14		CSA File No. LR 21451
EN60947-5-1		TÜV Rheinland
		EU Low Voltage Directive
GB14048.5		Contact IDEC for approval file no.

• See page 49 for approval ratings.

## Contact Ratings

### Gold Contact (switch base: blue)

Rated Insulation Voltage		250V	
Rated Thermal Current		3A	
Rated Operating Voltage		30V DC	125V AC
Rated Operating Current (electrical life: 100,000 operations)	Resistive Load	0.1A	0.1A
Contact Material		Gold-clad silver	

- Minimum applicable load (reference value): 5V AC/DC, 1 mA
- Applicable range is subject to the operating conditions and load.
- See electrical life in Specifications.

### Silver Contact (switch base: gray)

Rated Insulation Voltage		250V	
Rated Operating Voltage		30V	125V 250V
Rated Operating Current	Electrical Life 50,000 operations	AC 50/60Hz	Resistive load — 5A 5A
		DC	Inductive load — 3A 1.5A
	Electrical Life 100,000 operations	AC 50/60Hz	Resistive load 5A 1.1A —
		DC	Inductive load 2A 0.4A —
	AC 50/60Hz	Resistive load — 5A 3A	
		Inductive load — 3A 1.5A	
DC	Resistive load 3A 0.6A —		
	Inductive load 1A 0.22A —		
Rated Thermal Current		5A	
Contact Material		Silver	

- AC inductive load: PF=0.6 to 0.7 DC inductive load: L/R=7 ms max.

## LED Ratings

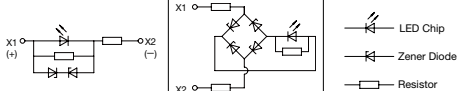
Rated Voltage	5V DC	12V AC/DC	24V AC/DC
Voltage Range	5V DC±5%	12V AC/DC±10%	24V AC/DC±10%
LED Part No.	LB9Z-LED5②	LB9Z-LED1②	LB9Z-LED2②
Current Draw	A, R, W: 18 mA G, S: 6 mA PW: 5 mA		
Voltage Marking	Marked on the side of the LED unit		
LED Life (reference value)	Approx. 30,000 hours [until the brightness reduces to 50% of the initial value when lit at the rated voltage (direct current) under 25°C environment.]		
Internal Circuit	 <p>A, G, R, PW, S, W</p>		

- ② (color code): A (amber), G (green), PW (pure white), R (red), S (blue), W (white)
- Use the pure white (PW) module for yellow illumination.
- LED lamp contains a current-limiting resistor.



## Specifications

Operating Temperature	-25 to +60°C (no freezing) Illuminated units: -25 to +55°C	
Storage Temperature	-30 to +80°C (no freezing)	
Operating Humidity	45 to 85% RH (no condensation)	
Contact Resistance	50 mΩ maximum (initial value)	
Insulation Resistance	100 MΩ minimum (500V DC megger)	
Dielectric Strength	Switch Unit	Between live part and ground: 2,000V AC, 1 minute Between terminals of different poles: 2,000V AC, 1 minute Between terminals of the same poles: 1,000V AC, 1 minute
	Illumination Unit	Between live part and ground: 2,000V AC, 1 minute
Vibration Resistance	Operating extremes/Damage limits: 5 to 55 Hz, amplitude 0.5 mm	
Shock Resistance	Operating extremes: 100 m/s <sup>2</sup> Damage limits: 1,000 m/s <sup>2</sup>	
Mechanical Life (minimum operations)	Momentary:	2,000,000
	Maintained:	250,000
	Selector switches	250,000
Electrical Life (minimum operations)	Momentary:	50,000 / 100,000 (*1)
	Maintained:	50,000 / 100,000 (*2)
	Selector switches:	50,000 / 100,000 (*2)
Degree of Protection	IP65 (IEC 60529)	
	Terminal Style	Solder/tab terminal #110 PC board terminal
Weight (approx.)	11g (LB3L-M1T24)	15g (LB8GL-M1T24)
	10g (LB3P-1T04)	14g (LB8GB-M1T2)
Weight (approx.)	10g (LB3B-M1T2)	16g (LBW7L-M1T24)
	12g (LB3S-2T2)	14g (LBW7P-1T04)
	25g (LB3K-2ST2A)	15g (LBW7B-M1T2)
	14g (LB8L-M1T24)	17g (LBW7S-2T2)
	13g (LB8P-1T04)	29g (LBW7K-2ST2A)
	13g (LB8B-M1T2)	17g (LBW7GL-M1T24)
	15g (LB8S-2T2)	18g (LBW7GB-M1T2)
	27g (LB8K-2ST2A)	

- \* 1: Switching frequency 1,800 operations/h.
- \* 2: Switching frequency 1,200 operations/h.

Flush Silhouette  
LB Series

Flush Silhouette  
LBW Series

ø16  
LB Series

UP Series

Illuminated  
Pushbutton

Pilot Light

Pushbutton

Selector

Illuminated  
Selector

Key Selector

Lever Switch

Buzzer

Accessories

Maintenance  
Parts

Panel  
Cut-out

Instructions

# Flush Silhouette Switches LB Series Illuminated Pushbuttons

## Illuminated Pushbuttons

Solder/Tab Terminal

Package Quantity:1

Part No. / Shape	LB①L-②1T③④⑤*						
				Round / Black Bezel	Square / Black Bezel	Rectangular / Black Bezel	
① Shape	② Operation	③ Contact	④ LED Operating Voltage	Part No.		* Illumination Color Code	
Black bezel	Momentary	Gold/SPDT	24V AC/DC	LB①L-M1T14*		Specify the color code in place of * in the Part No.  A: amber G: green PW: pure white R: red S: blue W: white Y: yellow	
		Gold/DPDT		LB①L-M1T24*			
	Maintained	Gold/SPDT	24V AC/DC	LB①L-A1T14*			
		Gold/DPDT		LB①L-A1T24*			
Metallic bezel	Momentary	Gold/SPDT	24V AC/DC	LB①L-M1T14*			
		Gold/DPDT		LB①L-M1T24*			
	Maintained	Gold/SPDT	24V AC/DC	LB①L-A1T14*			
		Gold/DPDT		LB①L-A1T24*			
Guard Type	Momentary	Gold/SPDT	24V AC/DC	LB①L-M1T14*			
		Gold/DPDT		LB①L-M1T24*			
	Maintained	Gold/SPDT	24V AC/DC	LB①L-A1T14*			
		Gold/DPDT		LB①L-A1T24*			

- Illuminated pushbuttons contain an LED unit. For details on LED units, see page 60.
- The guard opens 180 degrees spring-return.
- Illuminated pushbuttons can be used with legend markings. Engraving can be done on a marking plate which is placed in the lens, or a clear film can be printed and placed in the lens. See page 63 for details on the marking plate and film.
- White lens type (when light is off) are available. Clear lens is used instead of colored lens for amber, green, red, and blue illuminated pushbuttons. Amber, green, red, or blue LED units are used. To specify, see Part Number Development below.
- PC board terminals available for gold contacts. Silver contacts also available. To specify, see Part Number Development below.
- 5V DC and 12V AC/DC LED operating voltages also available.
- Other bezel sizes available (LBW series). For details, see page 24.

## Part Number Development

### LB①L-②1T③④⑤\*

#### ① Shape

Code	Shape
6	Round / Black Bezel
7	Square / Black Bezel
8	Rectangular / Black Bezel
6M	Round / Metallic Bezel
7M	Square / Metallic Bezel
8M	Rectangular / Metallic Bezel
6G	Round with Guard
7G	Square with Guard
8G	Rectangular with Guard

#### ② Operation

Code	Operation
A	Maintained
M	Momentary

#### ③ Contacts

Code	Contact
1	Gold/SPDT
2	Gold/DPDT
5	Silver/SPDT
6	Silver/DPDT

#### ④ LED Operating Voltage

Code	Rated Operating Voltage
1	5V DC
3	12V AC/DC
4	24V AC/DC

#### ⑤ Others

Code	Specification	Part No. Example
Blank	Solder/Tab Terminal	—
W	White Lens Type (When Light is Off)	LB6L-M1T14W*
V	PC Board Terminal (Gold Contact Only)	LB6L-M1T14V*
VW	White Lens Type (When Light is Off) with PC Board Terminal (Gold Contact Only)	LB6L-M1T14VW*

- Specify the color code in place of \* in the table above.
- Color code for white lens type (when light is off) : A (amber), G (green), R (red), S (blue)







# Flush Silhouette Switches LB Series Pilot Lights

## Pilot Lights

Solder/Tab Terminal

Package Quantity:1

Part No. / Shape	<b>LB①P-②T③④*</b>							
	 Round / Black Bezel    Square / Black Bezel    Rectangular / Black Bezel    Dome / Black Bezel    Round / Metallic Bezel    Square / Metallic Bezel    Rectangular / Metallic Bezel    Dome / Metallic Bezel							
② Lens Shape	① Shape	③ LED Operating Voltage	Part No.	* Illumination Color Code				
Flush	Black Bezel	24V AC/DC	<b>LB①P-1T04*</b>	Specify the color code in place of * in the Part No.  A: amber G: green PW: pure white R: red S: blue W: white Y: yellow				
	Metallic Bezel	24V AC/DC	<b>LB①P-1T04*</b>					
Dome	Black Bezel	24V AC/DC	<b>LB6P-2T04*</b>					
	Metallic Bezel	24V AC/DC	<b>LB6MP-2T04*</b>					

- Pilot lights contain an LED unit. For maintenance LED units see page 60.
- Legends and symbols can be engraved on a marking plate or film to be inserted under the lens by users for labelling purposes. See page 63 for details.
- White lens type (when light is off) are available. Clear lens is used instead of colored lens for amber, green, red, and blue pilot lights. Amber, green, red, or blue LED units are used. To specify, see Part Number Development below.
- PC board terminals available. To specify, see Part Number Development below.
- 5V DC and 12V AC/DC LED operating voltages also available.
- Other bezel sizes available (LBW series). For details, see page 26.

## Part Number Development

### LB①P-②T③④\*

#### ① Shape

Code	Shape
6	Round / Black Bezel
7	Square / Black Bezel
8	Rectangular / Black Bezel
6M	Round / Metallic Bezel
7M	Square / Metallic Bezel
8M	Rectangular / Metallic Bezel

- Round only for dome.

#### ② Lens Shape

Code	Lens Shape
1	Flush
2	Dome

#### ③ LED Operating Voltage

Code	Rated Operating Voltage
1	5V DC
3	12V AC/DC
4	24V AC/DC

#### ④ Others

Code	Specification	Part No. Example
Blank	Solder/Tab Terminal	—
W	White Lens Type (When Light is Off)	LB6P-1T04W*
V	PC Board Terminal	LB6P-1T04V*
VW	White Lens Type (When light is Off) with PC Board Terminal	LB6PPM1T04VW*

- Specify the color code in place of \* in the table above.
- Color code for white lens type (when light is off) : A (amber), G (green), R (red), S (blue)

# Flush Silhouette Switches LB Series Pilot Lights

## Dimensions

Flush Silhouette LB Series
Flush Silhouette LBW Series
ø16 LB Series
UP Series

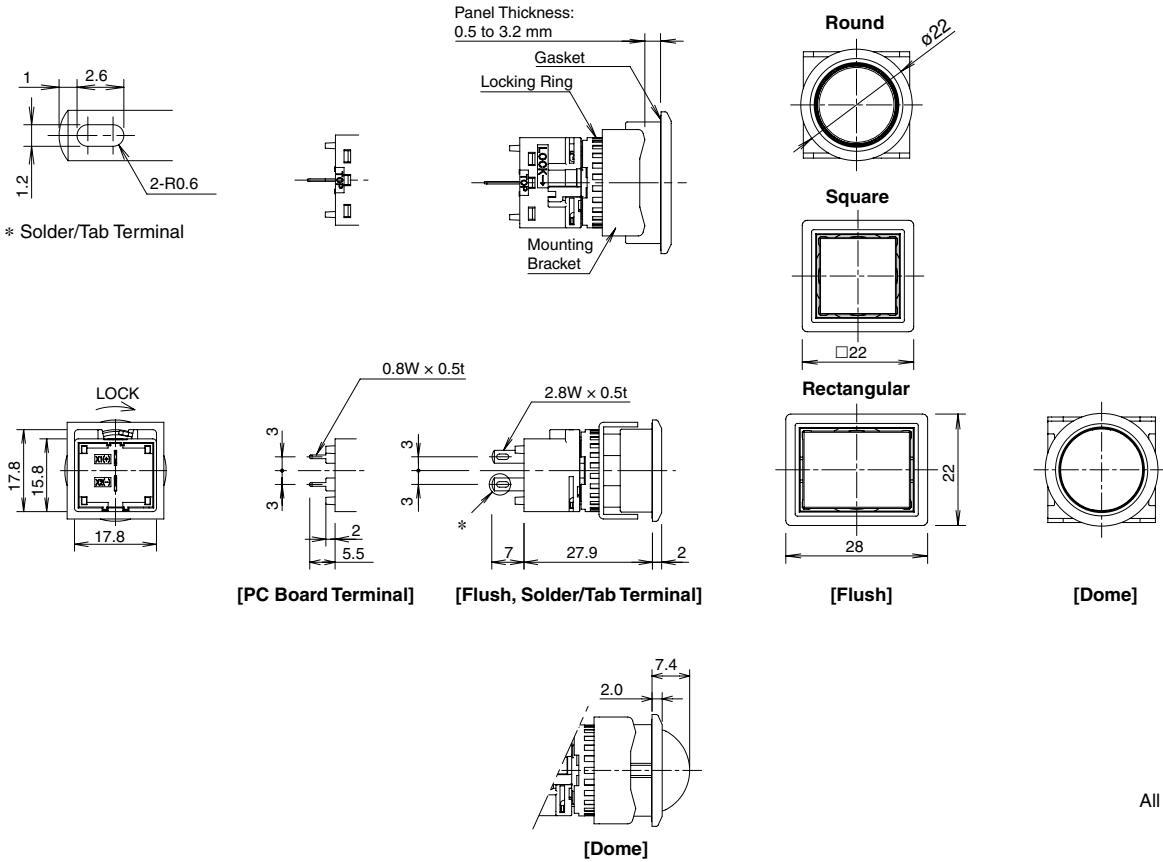

### Terminal Arrangement (Bottom View)

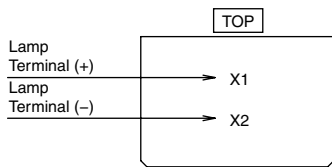

### Panel Cut-out for Positioning Round (LB6P/LB6MP)

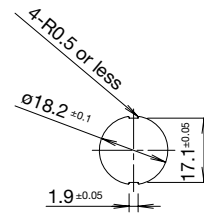

### Mounting Hole Layout

#### Round (LB6P/LB6MP)

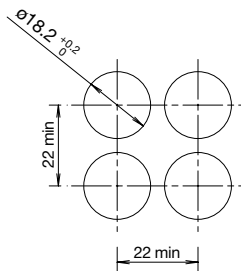

#### Square (LB7P/LB7MP)

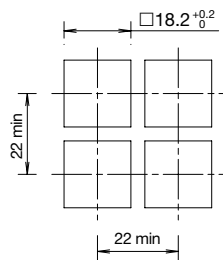

#### Square (LB8P/LB8MP)

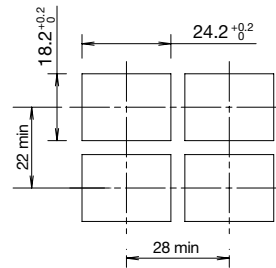

Note: When using rubber boot or terminal cover, see dimensions on page 57 and 58.

- For details on pc board and circuit design, see page 50.
- For details on single board mounting, see page 51.

Illuminated Pushbutton
<b>Pilot Light</b>
Pushbutton
Selector
Illuminated Selector
Key Selector
Lever Switch
Buzzer
Accessories
Maintenance Parts
Panel Cut-out
Instructions

# Flush Silhouette Switches LB Series Pushbuttons

## Pushbuttons

Solder/Tab Terminal

Package Quantity:1



① Shape	Button Style	② Operation	③ Contact	Part No.		* Color Code
				Gold Contact	Silver Contact	
Black bezel	Button	Momentary	SPDT	LB1B-M1T1*	LB1B-M1T5*	B: black G: green R: red S: blue W: white Y: yellow
			DPDT	LB1B-M1T2*	LB1B-M1T6*	
			3PDT	LB1B-M1T3*	LB1B-M1T7*	
		Maintained	SPDT	LB1B-A1T1*	LB1B-A1T5*	
			DPDT	LB1B-A1T2*	LB1B-A1T6*	
			3PDT	LB1B-A1T3*	LB1B-A1T7*	
	Lens	Momentary	SPDT	LB1B-M1T1L*	LB1B-M1T5L*	A: amber G: green R: red S: blue W: white Y: yellow
			DPDT	LB1B-M1T2L*	LB1B-M1T6L*	
			3PDT	LB1B-M1T3L*	LB1B-M1T7L*	
		Maintained	SPDT	LB1B-A1T1L*	LB1B-A1T5L*	
			DPDT	LB1B-A1T2L*	LB1B-A1T6L*	
			3PDT	LB1B-A1T3L*	LB1B-A1T7L*	
Metallic bezel	Button	Momentary	SPDT	LB1B-M1T1*	LB1B-M1T5*	B: black G: green R: red S: blue W: white Y: yellow
			DPDT	LB1B-M1T2*	LB1B-M1T6*	
			3PDT	LB1B-M1T3*	LB1B-M1T7*	
		Maintained	SPDT	LB1B-A1T1*	LB1B-A1T5*	
			DPDT	LB1B-A1T2*	LB1B-A1T6*	
			3PDT	LB1B-A1T3*	LB1B-A1T7*	
	Lens	Momentary	SPDT	LB1B-M1T1L*	LB1B-M1T5L*	A: amber G: green R: red S: blue W: white Y: yellow
			DPDT	LB1B-M1T2L*	LB1B-M1T6L*	
			3PDT	LB1B-M1T3L*	LB1B-M1T7L*	
		Maintained	SPDT	LB1B-A1T1L*	LB1B-A1T5L*	
			DPDT	LB1B-A1T2L*	LB1B-A1T6L*	
			3PDT	LB1B-A1T3L*	LB1B-A1T7L*	
Guard Type	Button	Momentary	SPDT	LB1B-M1T1*	LB1B-M1T5*	B: black G: green R: red S: blue W: white Y: yellow
			DPDT	LB1B-M1T2*	LB1B-M1T6*	
			3PDT	LB1B-M1T3*	LB1B-M1T7*	
		Maintained	SPDT	LB1B-A1T1*	LB1B-A1T5*	
			DPDT	LB1B-A1T2*	LB1B-A1T6*	
			3PDT	LB1B-A1T3*	LB1B-A1T7*	
	Lens	Momentary	SPDT	LB1B-M1T1L*	LB1B-M1T5L*	A: amber G: green R: red S: blue W: white Y: yellow
			DPDT	LB1B-M1T2L*	LB1B-M1T6L*	
			3PDT	LB1B-M1T3L*	LB1B-M1T7L*	
		Maintained	SPDT	LB1B-A1T1L*	LB1B-A1T5L*	
			DPDT	LB1B-A1T2L*	LB1B-A1T6L*	
			3PDT	LB1B-A1T3L*	LB1B-A1T7L*	

- The guard opens 180 degrees spring-return.
- Pushbuttons can be used with legend markings. Engraving can be done on a marking plate which is placed in the lens, or a clear film can be printed and placed in the lens. See page 63 for details on the marking plate and film.
- Black is available for lens. Black lens consists of a transparent lens and a black marking plate. To specify, see Part Number Development below.
- PC board terminals available for gold contacts. To specify, see Part Number Development below.
- Other bezel sizes available (LBW series). For details, see page 28.

## Part Number Development LB 1 B-2 1 T 3 4 \*

### ① Shape

Code	Shape
6	Round / Black Bezel
7	Square / Black Bezel
8	Rectangular / Black Bezel
6M	Round / Metallic Bezel
7M	Square / Metallic Bezel
8M	Rectangular / Metallic Bezel
6G	Round with Guard
7G	Square with Guard
8G	Rectangular with Guard

### ② Operation

Code	Operation
A	Maintained
M	Momentary

### ③ Contacts

Code	Contact	Code	Contact
1	Gold/SPDT	5	Silver/SPDT
2	Gold/DPDT	6	Silver/DPDT
3	Gold/3PDT	7	Silver/3PDT

### ④ Others

Code	Specification	Part No. Example
Blank	Solder/Tab Terminal	—
B	Black Translucent Lens (Lens Only)	LB6B-M1T1LB
V	PC Board Terminal (Gold Contact Only)	LB6B-M1T1V*

# Flush Silhouette Switches LB series Pushbuttons

## Dimensions

Flush Silhouette LB Series
Flush Silhouette LBW Series
ø16 LB Series
UP Series

All dimensions in mm.

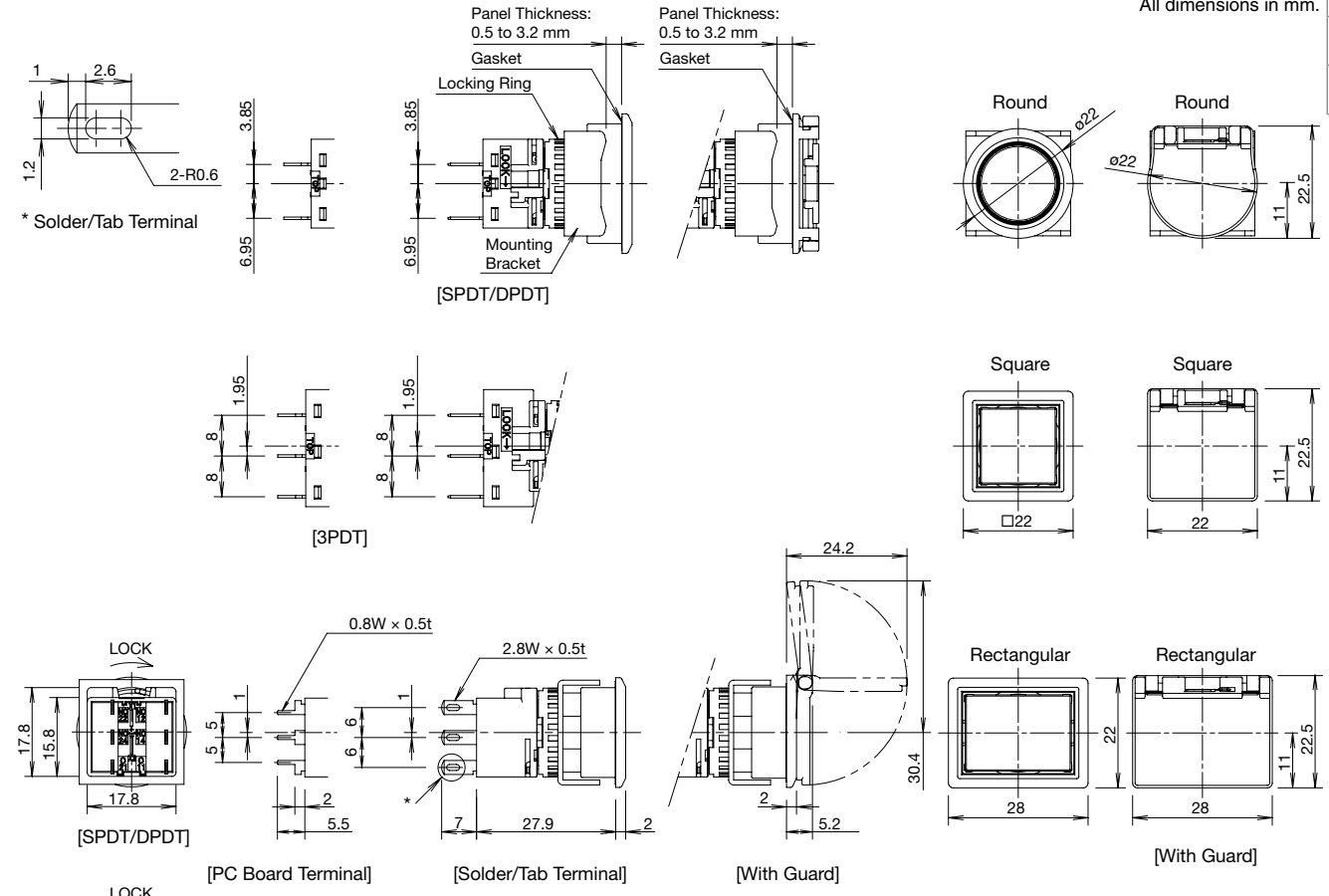

Illuminated Pushbutton
Pilot Light
Pushbutton
Selector
Illuminated Selector
Key Selector
Lever Switch
Buzzer
Accessories
Maintenance Parts
Panel Cut-out
Instructions

### Terminal Arrangement (Bottom View)

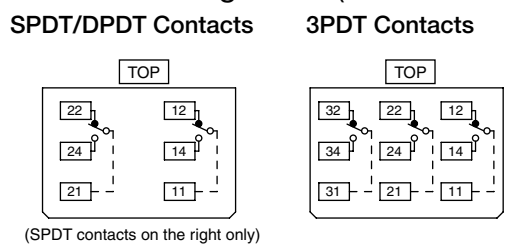

### Panel Cut-out for Positioning Round (LB6B/LB6MB/LB6GB)

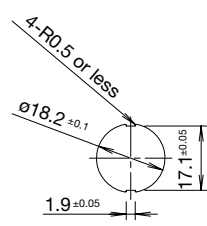

### Mounting Hole Layout

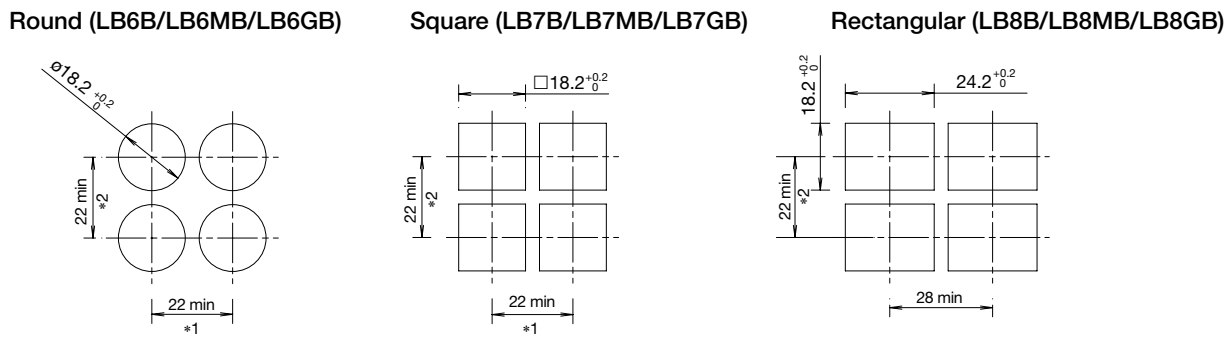

\*1: 23.2 mm minimum for 3PDT  
 \*2: 45 mm minimum for switches with guard  
 Note: When using rubber boot or terminal cover, see dimensions on page 57 and 58.

- For details on pc board and circuit design, see page 50.
- For details on single board mounting, see page 51.

# Flush Silhouette Switches LB Series Selector Switches

## Selector Switches

Solder/Tab Terminal

Package Quantity: 1

Part No. / Shape **LB** ① **S**-② ③ **T** ④ ⑤

Knob Operator

Round / Black Bezel    Square / Black Bezel    Rectangular / Black Bezel    Round / Metallic Bezel    Square / Metallic Bezel    Rectangular / Metallic Bezel

Lever Operator

Round / Metallic Bezel    Square / Metallic Bezel    Rectangular / Metallic Bezel

UL    CE    CE    CE

① Shape	② Operator Position		③ Contact	Part No.	
				Gold Contact	Silver Contact
Black bezel	90° 2-position	Maintained 	SPDT	<b>LB</b> ① <b>S</b> -2 <b>T</b> 1	<b>LB</b> ① <b>S</b> -2 <b>T</b> 5
			DPDT	<b>LB</b> ① <b>S</b> -2 <b>T</b> 2	<b>LB</b> ① <b>S</b> -2 <b>T</b> 6
			3PDT	<b>LB</b> ① <b>S</b> -2 <b>T</b> 3	<b>LB</b> ① <b>S</b> -2 <b>T</b> 7
	45° 3-position	Maintained 	DPDT	<b>LB</b> ① <b>S</b> -3 <b>T</b> 2	<b>LB</b> ① <b>S</b> -3 <b>T</b> 6
			3PDT	<b>LB</b> ① <b>S</b> -3 <b>T</b> 3	<b>LB</b> ① <b>S</b> -3 <b>T</b> 7
		Spring return two-way 	DPDT	<b>LB</b> ① <b>S</b> -3 <b>T</b> 2	<b>LB</b> ① <b>S</b> -3 <b>T</b> 6
		3PDT	<b>LB</b> ① <b>S</b> -3 <b>T</b> 3	<b>LB</b> ① <b>S</b> -3 <b>T</b> 7	
Metallic bezel	90° 2-position	Maintained 	SPDT	<b>LB</b> ① <b>S</b> -2 <b>T</b> 1	<b>LB</b> ① <b>S</b> -2 <b>T</b> 5
			DPDT	<b>LB</b> ① <b>S</b> -2 <b>T</b> 2	<b>LB</b> ① <b>S</b> -2 <b>T</b> 6
			3PDT	<b>LB</b> ① <b>S</b> -2 <b>T</b> 3	<b>LB</b> ① <b>S</b> -2 <b>T</b> 7
	45° 3-position	Maintained 	DPDT	<b>LB</b> ① <b>S</b> -3 <b>T</b> 2	<b>LB</b> ① <b>S</b> -3 <b>T</b> 6
			3PDT	<b>LB</b> ① <b>S</b> -3 <b>T</b> 3	<b>LB</b> ① <b>S</b> -3 <b>T</b> 7
		Spring return two-way 	DPDT	<b>LB</b> ① <b>S</b> -3 <b>T</b> 2	<b>LB</b> ① <b>S</b> -3 <b>T</b> 6
		3PDT	<b>LB</b> ① <b>S</b> -3 <b>T</b> 3	<b>LB</b> ① <b>S</b> -3 <b>T</b> 7	

- Lever operators also available. To specify, see Part Number Development below.
- PC board terminals available for gold contacts. To specify, see Part Number Development below.
- 2-position spring return from right, 3-position spring return from right, and 3-position spring return from left also available. To specify, see Part Number Development below.
- For contact operation, see page 48.
- Other bezel sizes available (LBW series). For details, see page 30.

## Part Number Development

### LB ① S-② ③ T ④ ⑤

#### ① Shape

Code	Shape
6	Round / Black Bezel
7	Square / Black Bezel
8	Rectangular / Black Bezel
6M	Round / Metallic Bezel
7M	Square / Metallic Bezel
8M	Rectangular / Metallic Bezel

#### ② Operator Position

##### 2-position

Operator Position	
2 Maintained 	21 Spring return from right 

##### 3-position

Operator Position			
3 Maintained 	31 Spring return from right 	32 Spring return from left 	33 Spring return two-way 

#### ③ Operator

Code	Operator Shape
Blank	Knob
L	Lever

#### ④ Contacts

Code	Contact
1	Gold/SPDT (90° 2-position only)
2	Gold/DPDT
3	Gold/3PDT
5	Silver/SPDT (90° 2-position only)
6	Silver/DPDT
7	Silver/3PDT

#### ⑤ Others

Code	Specification	Part No. Example
Blank	Solder/Tab Terminal	—
V	PC Board Terminal (Gold Contact Only)	LB6S-2T1V

# Flush Silhouette Switches LB Series Selector Switches

Flush Silhouette LB Series
Flush Silhouette LBW Series
ø16 LB Series
UP Series

## Dimensions

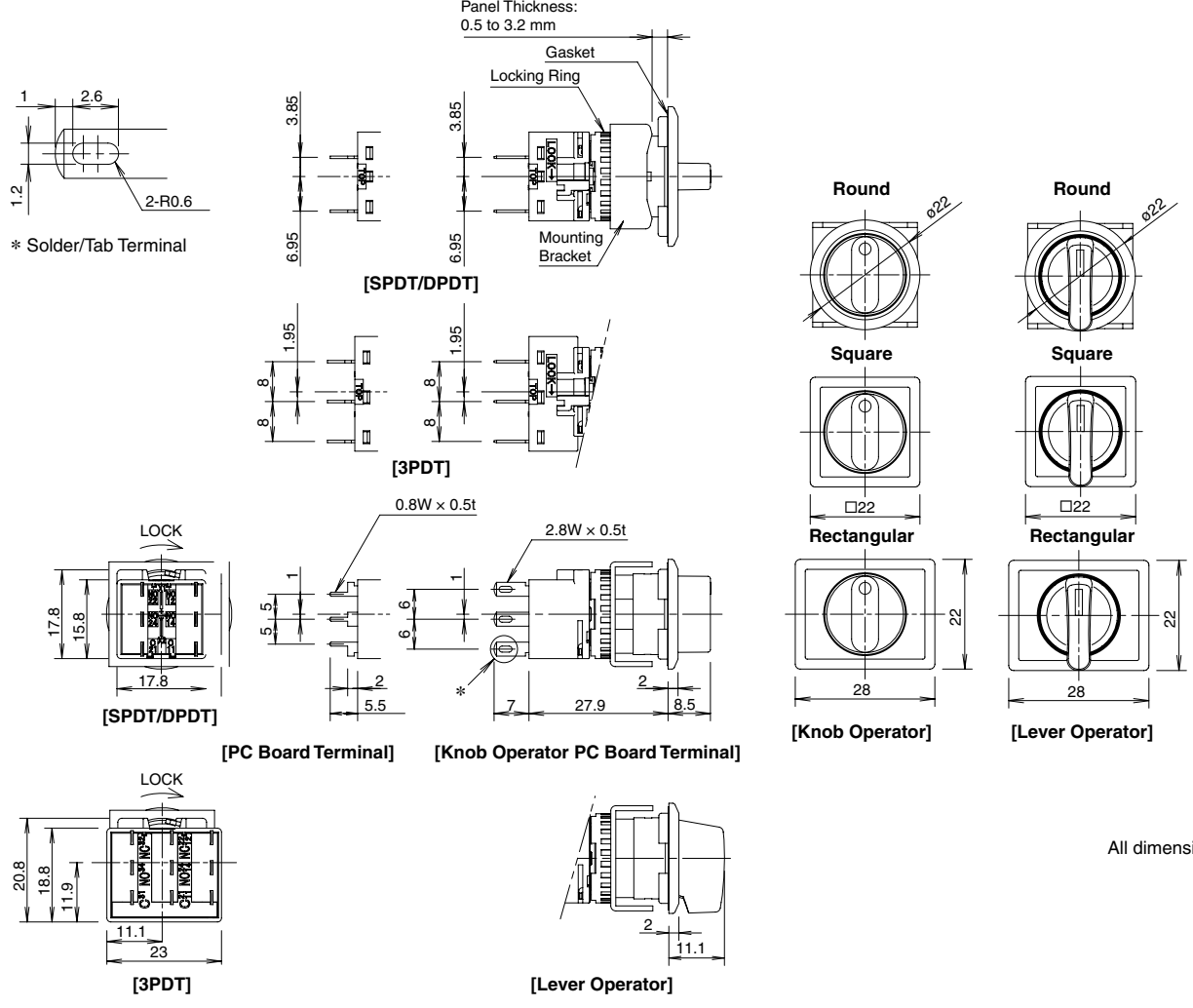

All dimensions in mm.

Illuminated Pushbutton
Pilot Light
Pushbutton
Selector
Illuminated Selector
Key Selector
Lever Switch
Buzzer
Accessories
Maintenance Parts
Panel Cut-out
Instructions

### Terminal Arrangement (Bottom View)

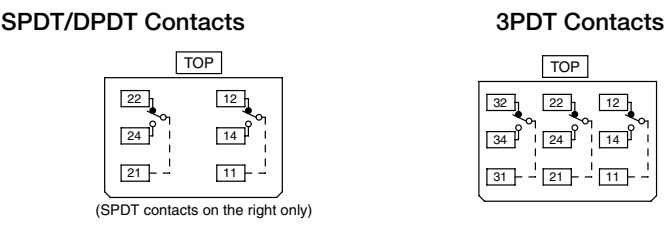

### Panel Cut-out for Positioning

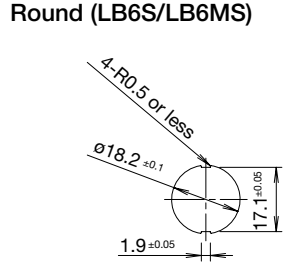

### Mounting Hole Layout

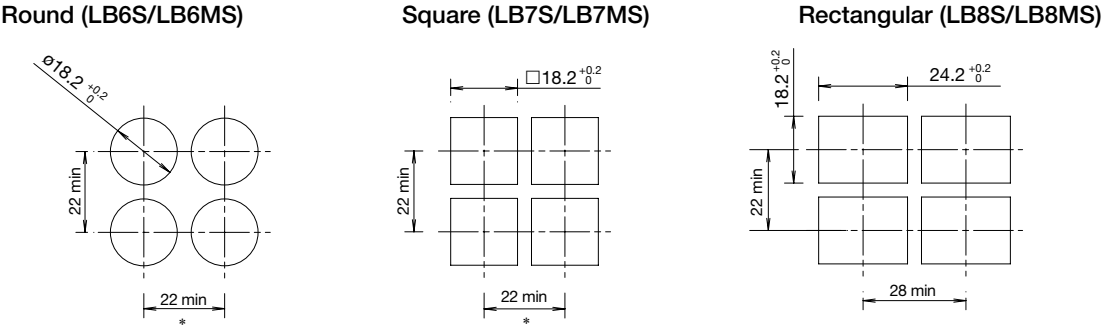

\*: 23.2 mm minimum for 3PDT  
 Note: When using rubber boot or terminal cover, see dimensions on page 58.









- For details on pc board and circuit design, see page 50.
- For details on single board mounting, see page 51.

# Flush Silhouette Switches LB series Illuminated Selector Switches

## Illuminated Selector Switches

Solder/Tab Terminal

Package Quantity: 1

Part No. / Shape	LB①F-②T③④⑤*						
	 Round / Black Bezel		 Square / Black Bezel		 Round / Metallic Bezel		
① Shape	② Operator Position		③ Contact	④ LED Operating Voltage	Part No.		* Illumination Color Code
					Gold Contact	Silver Contact	
Black bezel	90° 2-position	Maintained 	SPDT	24V AC/DC	LB①F-2T14*	LB①F-2T54*	Specify the color code in place of * in the Part No.  G: green R: red W: white
			DPDT	24V AC/DC	LB①F-2T24*	LB①F-2T64*	
Metallic bezel	45° 3-position	Maintained 	DPDT	24V AC/DC	LB①F-3T24*	LB①F-3T64*	
Metallic bezel	90° 2-position	Maintained 	SPDT	24V AC/DC	LB①F-2T14*	LB①F-2T54*	
			DPDT	24V AC/DC	LB①F-2T24*	LB①F-2T64*	
Metallic bezel	45° 3-position	Maintained 	DPDT	24V AC/DC	LB①F-3T24*	LB①F-3T64*	

- Illuminated selector switches contain an LED unit. For maintenance LED units see page 60.
- PC board terminals available for gold contacts. To specify, see Part Number Development below.
- 5V DC and 12V AC/DC LED operating voltages also available. To specify, see Part Number Development below.
- For contact operation, see page 48.



## Part Number Development

LB①F-②T③④⑤\*

### ① Shape

Code	Shape
6	Round / Black Bezel
6M	Round / Metallic Bezel

### ② Operator Position

Operator Position	
2-position	3-position
2 Maintained 	3 Maintained 

### ③ Contacts

Code	Contact
1	Gold/SPDT (90° 2-position only)
2	Gold/DPDT
5	Silver/SPDT (90° 2-position only)
6	Silver/DPDT

### ④ LED Operating Voltage

Code	Rated Operating Voltage
1	5V DC
3	12V AC/DC
4	24V AC/DC

### ⑤ Others

Code	Specification	Part No. Example
Blank	Solder/Tab Terminal	—
V	PC Board Terminal (Gold Contact Only)	LB6F-2T14V*

- Specify a color code in place of \* in the Part No.



# Flush Silhouette Switches LB Series Illuminated Selector Switches

Flush Silhouette LB Series
Flush Silhouette LBW Series
ø16 LB Series
UP Series

## Dimensions

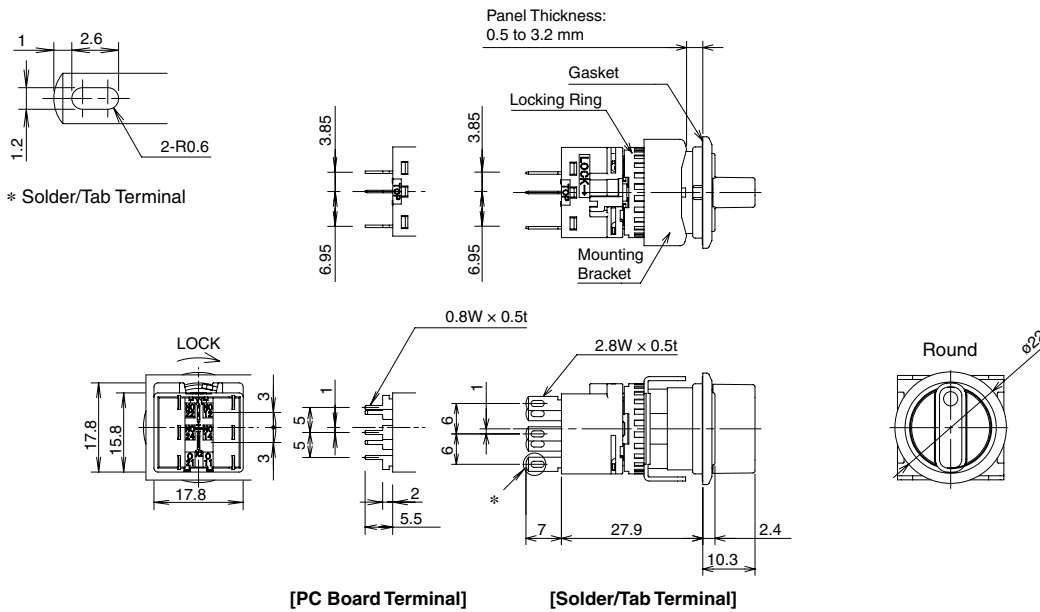

All dimensions in mm.

## Terminal Arrangement (Bottom View)

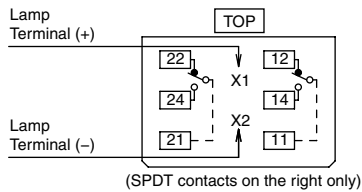

## Mounting Hole Layout

### Round (LB6F/LB6MF)

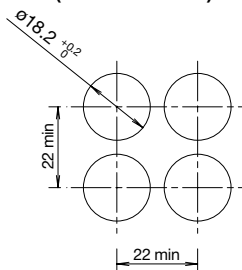

## Panel Cut-out for Positioning

### Round (LB6F/LB6MF)

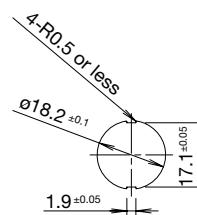

Note: When using terminal cover, see dimensions on page 58.

- For details on pc board and circuit design, see page 50.
- For details on single board mounting, see page 51.

Illuminated Pushbutton
Pilot Light
Pushbutton
Selector
<b>Illuminated Selector</b>
Key Selector
Lever Switch
Buzzer
Accessories
Maintenance Parts
Panel Cut-out
Instructions

# Flush Silhouette Switches LB series Key Selector Switches

## Key Selector Switches

Solder/Tab Terminal

Package Quantity:1

Part No. / Shape	LB①K-②③T④⑤-⑥										
	Round / Black Bezel		Square / Black Bezel		Rectangular / Black Bezel		Round / Metallic Bezel		Square / Metallic Bezel		Rectangular / Metallic Bezel
① Shape	② Operator Position		⑤ Key Removable Position	④ Contact	Part No.						
					Gold Contact	Silver Contact					
Black bezel	90° 2-position	Maintained	A: Key removable in all positions	SPDT	LB①K-2ST1A	LB①K-2ST5A					
				DPDT	LB①K-2ST2A	LB①K-2ST6A					
				3PDT	LB①K-2ST3A	LB①K-2ST7A					
	45° 3-position	Maintained	A: Key removable in all positions	DPDT	LB①K-3ST2A	LB①K-3ST6A					
				3PDT	LB①K-3ST3A	LB①K-3ST7A					
				3PDT	LB①K-3ST3A	LB①K-3ST7A					
Metallic bezel	90° 2-position	Maintained	A: Key removable in all positions	SPDT	LB①K-2ST1A	LB①K-2ST5A					
				DPDT	LB①K-2ST2A	LB①K-2ST6A					
				3PDT	LB①K-2ST3A	LB①K-2ST7A					
	45° 3-position	Maintained	A: Key removable in all positions	DPDT	LB①K-3ST2A	LB①K-3ST6A					
				3PDT	LB①K-3ST3A	LB①K-3ST7A					
				3PDT	LB①K-3ST3A	LB①K-3ST7A					

- For operator position, see Part Number Development below.
- For key removable position, see Part Number Development below. The key cannot be removed at the return position.
- Two keys are supplied.
- Besides the standard key (key number 0H), six other keys are available. To specify, see Part Number Development below.
- Disc tumbler keys also available. Only the standard key is available. To specify, see Part Number Development below.
- PC board terminals available for gold contacts. To specify, see Part Number Development below.
- For contact operation, see page 48.
- Other bezel sizes available (LBW series). For details, see page 32.

### Part Number Development

#### LB①K-②③T④⑤-⑥

##### ① Shape

Code	Shape
6	Round / Black Bezel
7	Square / Black Bezel
8	Rectangular / Black Bezel
6M	Round / Metallic Bezel
7M	Square / Metallic Bezel
8M	Rectangular / Metallic Bezel

##### ② Operator Position

Code	Operator Position
2	90° 2-position maintained
21	90° 2-position spring return from right
3	45° 3-position maintained
31	45° 3-position spring return from right
32	45° 3-position spring return from left
33	45°-3-position spring return two-way

##### ③ Key Style

Code	Key Style
S	Wave key
Blank	Disc tumbler key

##### ⑥ Key Number

Code	Key Number
Blank	Standard key (0H)
1H to 2H	Reversible key
3H to 6H	Non-reversible key

##### ④ Contacts

Code	Contact
1	Gold/SPDT (90° 2-position only)
2	Gold/DPDT
3	Gold/3PDT
5	Silver/SPDT (90° 2-position only)
6	Silver/DPDT
7	Silver/3PDT

- Wave key only.

##### ⑤ Key Removal Position

2-position

Key Removable Position			Spring return from right
A: Key removable in all positions	B: Key removable at left	C: Key removable at right	

3-position

Key Removable Position			
A: Key removable in all positions	B: Key removable at left / center	C: Key removable at center / right	D: Key removable at center
E: Key removable at right / left	G: Key removable at left	H: Key removable at right	

For key selectors with the following operations, the key cannot be removed at the return position.

3-position

Spring return from right	Spring return from left	Spring return two-way

- Key is removable at L, C, R. Key is retained at L, C, and R.

##### Others

Code	Specification	Part No. Example
Blank	Solder/Tab Terminal	—
V	PC Board Terminal (Gold Contact Only)	LB6K-2ST1VA

# Flush Silhouette Switches LB Series Key Selector Switches

## Dimensions

Flush Silhouette LB Series
Flush Silhouette LBW Series
ø16 LB Series
UP Series

### Key Selector Switches with Wave Key

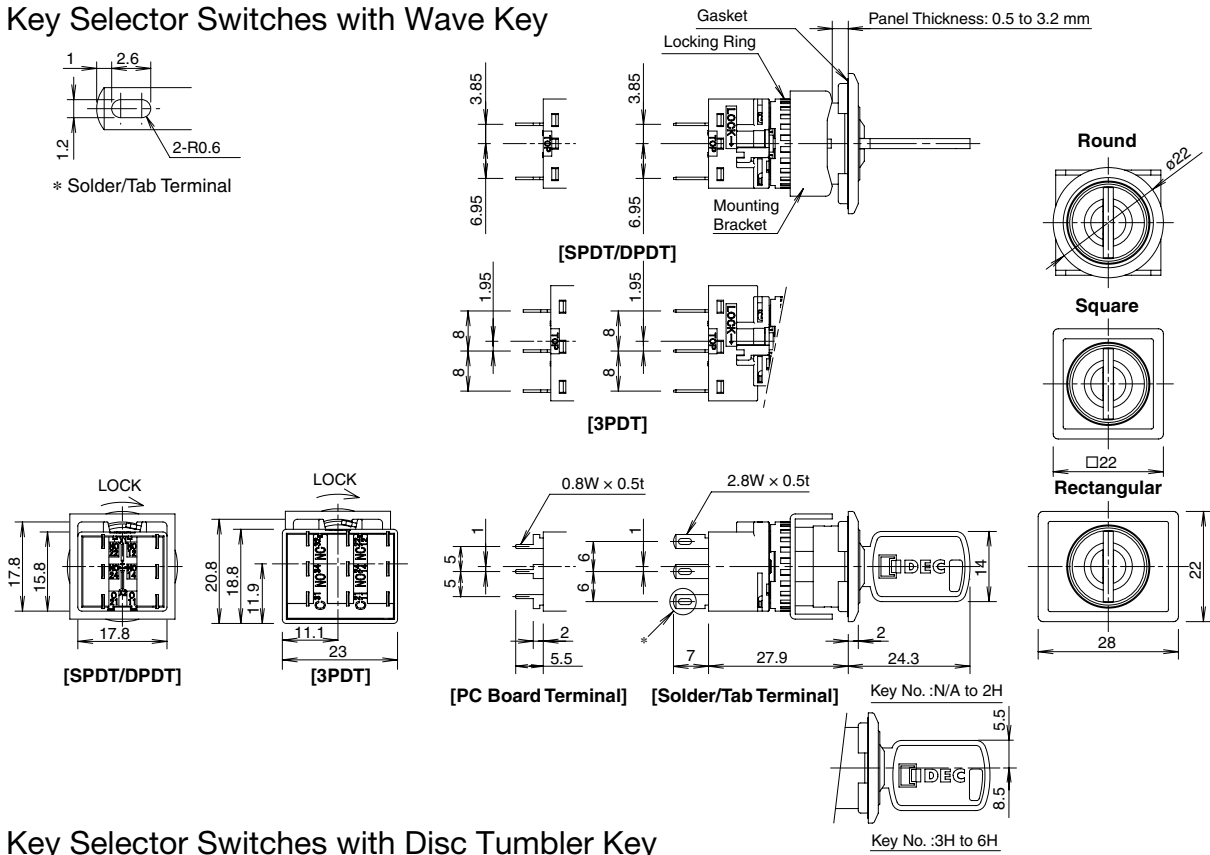

### Key Selector Switches with Disc Tumbler Key

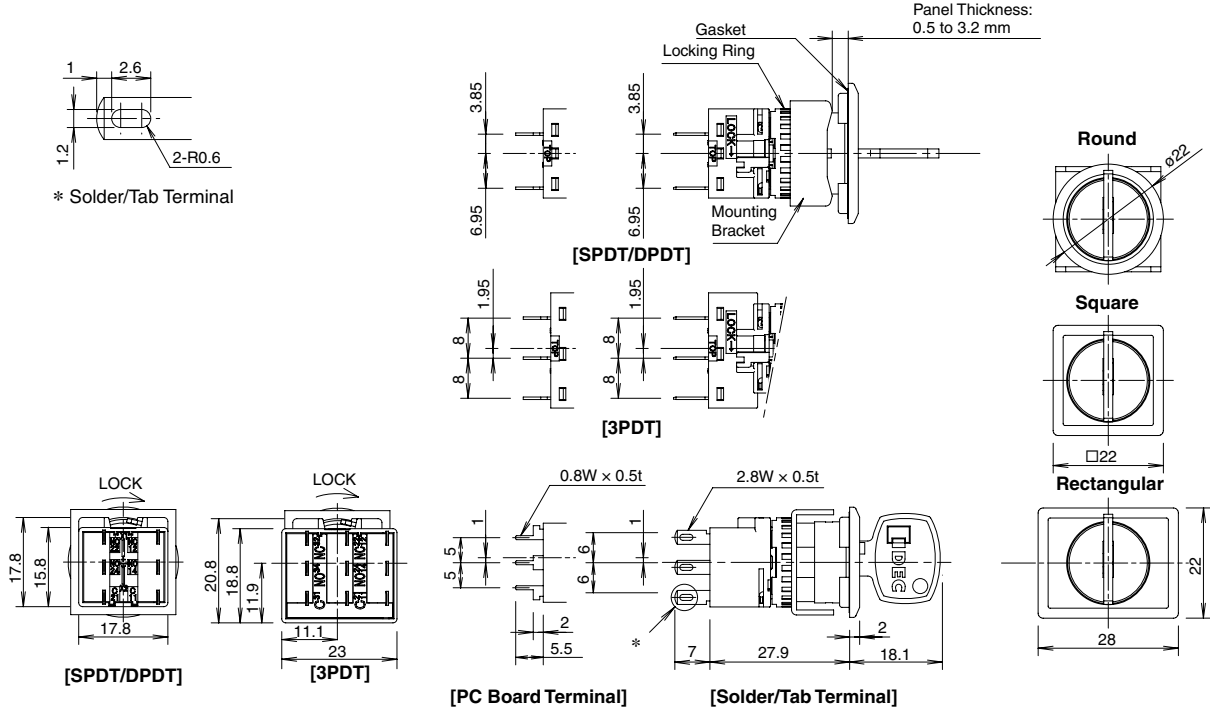

### Terminal Arrangement (Bottom View)

SPDT/DPDT Contacts

3PDT Contacts

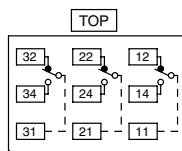
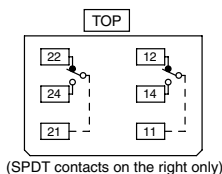

- For details on mounting hole layout, see page 49.
- For details on pc board and circuit design, see page 50.
- For details on single board mounting, see page 51.

All dimensions in mm.





Illuminated Pushbutton
Pilot Light
Pushbutton
Selector
Illuminated Selector
<b>Key Selector</b>
Lever Switch
Buzzer
Accessories
Maintenance Parts
Panel Cut-out
Instructions

# Flush Silhouette Switches LB Series Lever Switches

## Lever Switches

Solder/Tab Terminal

Package Quantity: 1

Part No. / Shape					
	 Round / Black Bezel				
Shape	Operator Position		Contact	Part No.	
				Gold Contact	Silver Contact
Black bezel	2-position	Maintained 	SPDT	<b>LB6T-2T1</b>	<b>LB6T-2T5</b>
			DPDT	<b>LB6T-2T2</b>	<b>LB6T-2T6</b>
			3PDT	<b>LB6T-2T3</b>	<b>LB6T-2T7</b>
	3-position	Maintained 	DPDT	<b>LB6T-3T2</b>	<b>LB6T-3T6</b>
			3PDT	<b>LB6T-3T3</b>	<b>LB6T-3T7</b>
		Spring return from top/bottom 	DPDT	<b>LB6T-33T2</b>	<b>LB6T-33T6</b>
		3PDT	<b>LB6T-33T3</b>	<b>LB6T-33T7</b>	

- PC board terminals available for gold contacts. Add "V" to the Part No.  
Example: **LB6T-2T1V**
- For contact operation, see page 48.



# Flush Silhouette Switches LB Series Buzzers

## Buzzers

### Specifications

Rated Insulation Voltage	30V
Rated Operating Voltage	12, 24V DC
Operating Voltage Range	12V DC±10%, 24V DC±10%
Current Draw	26 mA
Inrush Current	80 mA maximum
Sound Pressure (at 0.1m)	Steady sound: 80 dB minimum (at the rated voltage)
Sound Frequency	2.3±0.3kHz
Response Speed	50 ms maximum
Operating Temperature	-25 to +60°C (no freezing)
Storage Temperature	-30 to +80°C(no freezing)
Operating Humidity	45 to 85% (no condensation)
Insulation Resistance	100 MΩ minimum (500V DC megger)
Dielectric Strength	Between live and dead parts: 1,000V AC, 1 minute
Vibration Resistance	Operating extremes/Damage limits: 5 to 55 Hz, amplitude 0.5 mm
Shock Resistance	Operating extremes: 100m/s <sup>2</sup> Damage limits:1,000m/s <sup>2</sup>
Life	1,000 hours minimum (beep sound)
Degree of Protection	IP54 (IEC60529)
Terminal Style	Solder/tab terminal #110 PC board terminal
Weight (approx.)	13g (round), 14g (square)

### Standards

Safety Standards	Mark	File No. or Organization
UL60947-1 UL60947-4-1A		UL Recognition File No.E68961
CSA C22.2 No.14		CSA File No.LR21451
EN60947-5-1 EN61000-6-4		EMC Directive

• UL, CSA ratings: Operating voltage 12, 24V DC.

Package Quantity: 1

Part No. / Shape					
		<p>Round / Black Bezel    Rectangular / Black Bezel    Round / Metallic Bezel    Rectangular / Metallic Bezel</p>			
Shape	Operating Voltage	Degree of Protection	Part No.		
			Terminal Style		
			Solder/tab terminal	PC board terminal	
Black bezel	Round	24V DC	IP54	<b>LB6Z-1T04</b>	<b>LB6Z-1T04V</b>
	Rectangular	24V DC	IP54	<b>LB8Z-1T04</b>	<b>LB8Z-1T04V</b>
Metallic bezel	Round	24V DC	IP54	<b>LB6MZ-1T04</b>	<b>LB6MZ-1T04V</b>
	Rectangular	24V DC	IP54	<b>LB8MZ-1T04</b>	<b>LB8MZ-1T04V</b>

• 12V DC operating voltages also available. Specify "-1T04" in place of "-1T03" in the Part No.  
Example: **LB6Z-1T03**





# Flush Silhouette Switches LBW series Illuminated Pushbuttons

## Illuminated Pushbuttons

Solder/Tab Terminal

Package Quantity:1

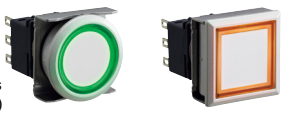
Part No. / Shape	LBW ① L - ② ③ T ④ ⑤ ⑥ *					
	<div style="display: flex; justify-content: space-around;"> <div style="text-align: center;"> <p><b>Flush</b></p>  <p>Round / Black Bezel    Square / Black Bezel    Round / Metallic Bezel    Square / Metallic Bezel    Round with Guard    Square with Guard</p> </div> <div style="text-align: center;"> <p><b>Extended</b></p>  <p>(black bezel is also available)</p> </div> <div style="text-align: center;"> <p><b>Flush Ring-illuminated</b></p>  <p>(black bezel is also available)</p> </div> </div>					
① Shape	② Operation	④ Contact	⑤ LED Operating Voltage	Part No.	* Illumination Color Code	
Black bezel	Momentary	Gold/SPDT	24V AC/DC	LBW①L-M③T14*	Specify the color code in place of * in the Part No.  A: amber G: green PW: pure white R: red S: blue W: white Y: yellow	
		Gold/DPDT		LBW①L-M③T24*		
	Maintained	Gold/SPDT	24V AC/DC	LBW①L-A③T14*		
		Gold/DPDT		LBW①L-A③T24*		
Metallic bezel	Momentary	Gold/SPDT	24V AC/DC	LBW①L-M③T14*		
		Gold/DPDT		LBW①L-M③T24*		
	Maintained	Gold/SPDT	24V AC/DC	LBW①L-A③T14*		
		Gold/DPDT		LBW①L-A③T24*		
Guard Type	Momentary	Gold/SPDT	24V AC/DC	LBW①L-M③T14*		
		Gold/DPDT		LBW①L-M③T24*		
	Maintained	Gold/SPDT	24V AC/DC	LBW①L-A③T14*		
		Gold/DPDT		LBW①L-A③T24*		

- Flush/Extended color code: A (amber), G (green), PW (pure white), R (red), S (blue), W (white), Y (yellow)
- Ring-illuminated color code: PW (pure white), W (white), WA (amber), WG (green), WR (red), WS (blue)
- Illuminated pushbuttons contain an LED unit. For details on LED units, see page 60.
- The guard opens 180 degrees spring-return.
- Illuminated pushbuttons can be used with legend markings. Engraving can be done on a marking plate which is placed in the lens, or a clear film can be printed and placed in the lens. See page 64 for details on the marking plate and film.
- White lens type (when light is off) are available. Clear lens is used instead of colored lens for amber, green, red, and blue illuminated pushbuttons. Amber, green, red, or blue LED units are used. To specify, see Part Number Development below.
- PC board terminals available for gold contacts. Silver contacts also available. To specify, see Part Number Development below.
- Extended style is available. See Part Number Development below (③).
- Flush ring-illuminated style is available. See Part Number Development below (③). Guard is not available with flush ring-illuminated style.
- 5V DC and 12V AC/DC LED operating voltages also available.
- Other bezel sizes available (LB series). For details, see page 8.

## Part Number Development

LBW ① L - ② ③ T ④ ⑤ ⑥ \*

### ① Shape

Code	Shape
6	Round / Black Bezel
7	Square / Black Bezel
6M	Round / Metallic Bezel
7M	Square / Metallic Bezel
6G	Round with Guard
7G	Square with Guard

### ② Operation

Code	Operation
A	Maintained
M	Momentary

### ③

Code	Operator Style
1	Flush
2	Extended
1R	Flush Ring-illuminated

### ④ Contacts

Code	Contact
1	Gold/SPDT
2	Gold/DPDT
5	Silver/SPDT
6	Silver/DPDT

### ⑤ LED Operating Voltage

Code	Rated Operating Voltage
1	5V DC
3	12V AC/DC
4	24V AC/DC

### ⑥ Others

Code	Specification	Part No. Example
Blank	Solder/Tab Terminal	—
W	White Lens Type (When Light is Off)	LBW6L-M1T14W*
V	PC Board Terminal (Gold Contact Only)	LBW6L-M1T14V*
VW	White Lens Type (When Light is Off) with PC Board Terminal (Gold Contact Only)	LBW6L-M1T14VW*

- Specify the color code in place of \* in the table above.
- Color code for white lens type (when light is off) : A (amber), G (green), R (red), S (blue)



# Flush Silhouette Switches LBW series Illuminated Pushbuttons

Flush Silhouette LB Series
Flush Silhouette LBW Series
ø16 LB Series
UP Series

## Dimensions

### Flush/Ring-illuminated

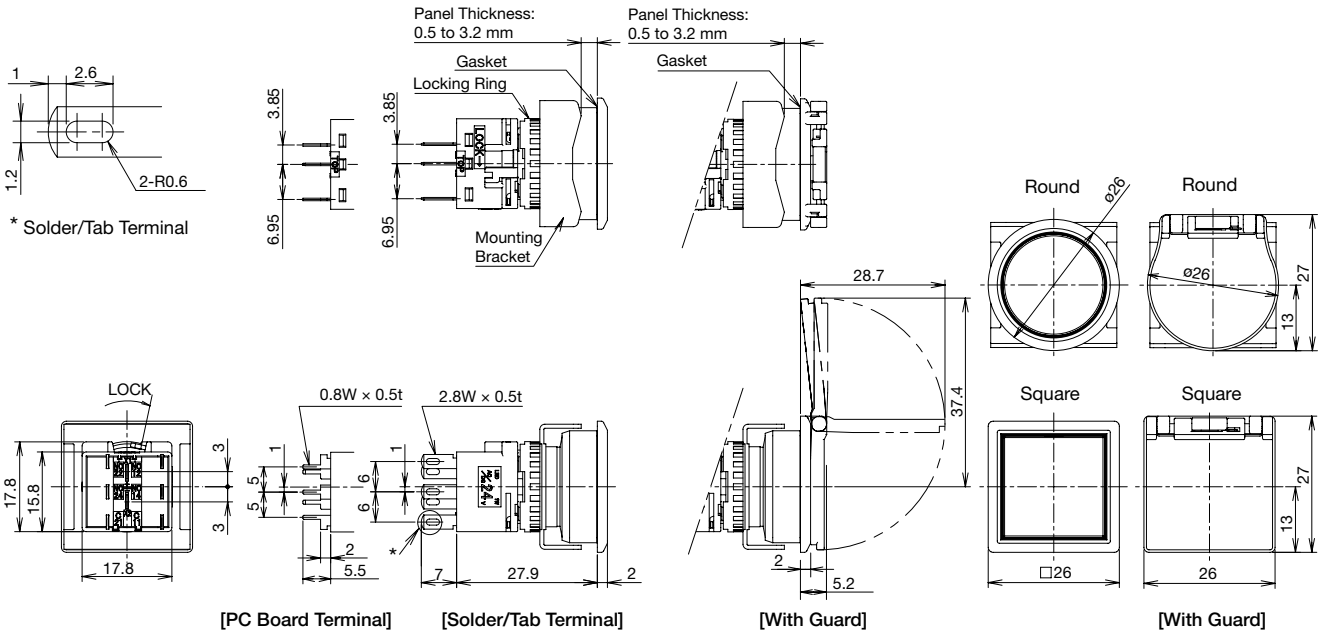

### Extended

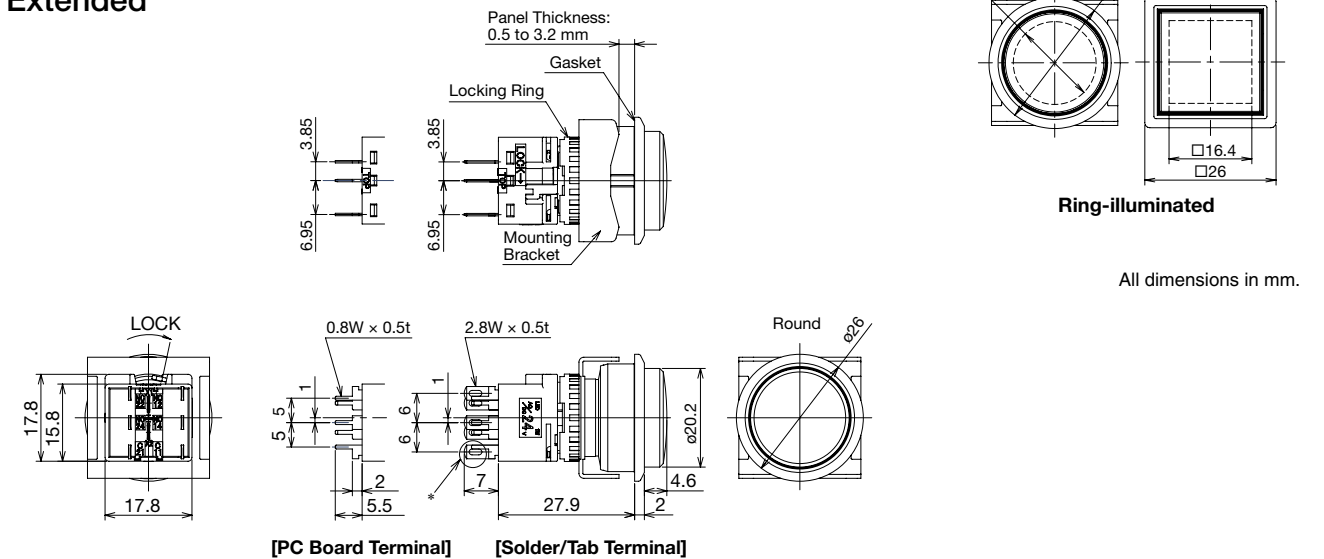

### Terminal Arrangement (Bottom View)

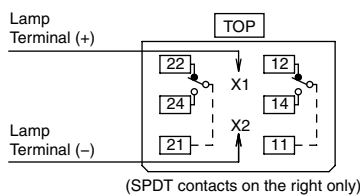

### Mounting Hole Layout

Round (LBW6/LBW6M)

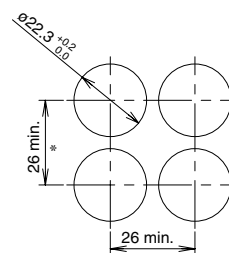

Square (LBW7/LBW7M)

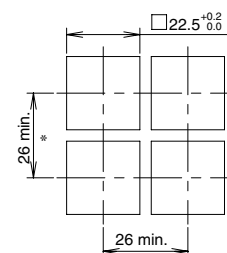

- For details on pc board and circuit design, see page 50.
- For details on single board mounting, see page 51.

\*: 53 mm minimum for switches with guard.



Illuminated Pushbutton
Pilot Light
Pushbutton
Selector
Illuminated Selector
Key Selector
Lever Switch
Buzzer
Accessories
Maintenance Parts
Panel Cut-out
Instructions

# Flush Silhouette Switches LBW Series Pilot Lights

## Pilot Lights

Solder/Tab Terminal

Package Quantity: 1

Part No. / Shape	LBW①P-1T0②③*			
				
① Shape	③ LED Operating Voltage	Part No.	* Illumination Color Code	
Black Bezel	24V AC/DC	LBW①P-1T04*	Specify the color code in place of * in the Part No. A: amber G: green PW: pure white R: red S: blue W: white Y: yellow	
Metallic Bezel	24V AC/DC	LBW①P-1T04*		

- Pilot lights contain an LED unit. For maintenance LED units see page 60.
- Legends and symbols can be engraved on a marking plate or film to be inserted under the lens by users for labelling purposes. See page 64 for details.
- White lens type (when light is off) are available. Clear lens is used instead of colored lens for amber, green, red, and blue pilot lights. Amber, green, red, or blue LED units are used. To specify, see Part Number Development below.
- PC board terminals available. To specify, see Part Number Development below.
- 5V DC and 12V AC/DC LED operating voltages also available.
- Other bezel sizes available (LBW series). For details, see page 10.

## Part Number Development

### LBW①P-1T0②③\*

#### ① Shape

Code	Shape
6	Round / Black Bezel
7	Square / Black Bezel
6M	Round / Metallic Bezel
7M	Square / Metallic Bezel

#### ② LED Operating Voltage

Code	Rated Operating Voltage
1	5V DC
3	12V AC/DC
4	24V AC/DC

#### ③ Others

Code	Specification	Part No. Example
Blank	Solder/Tab Terminal	—
W	White Lens Type (When Light is Off)	LBW6P-1T04W*
V	PC Board Terminal	LBW6P-1T04V*
VW	White Lens Type (When light is Off) with PC Board Terminal	LBW6P-1T04VW*

- Specify the color code in place of \* in the table above.
- Color code for white lens type: A (amber), G (green), R (red), and S (blue) only.

# Flush Silhouette Switches LBW Series Pilot Lights

Flush Silhouette LB Series
Flush Silhouette LBW Series
ø16 LB Series
UP Series

## Dimensions

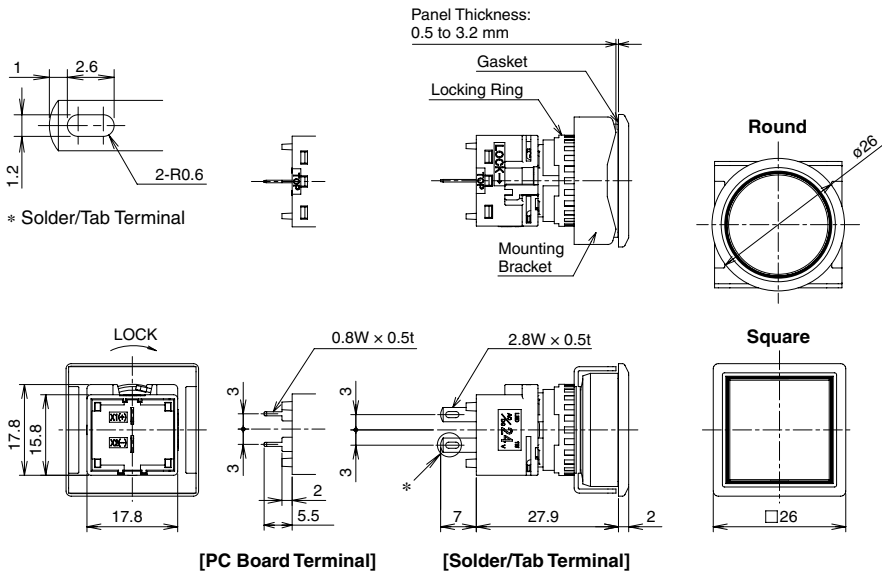

All dimensions in mm.

## Terminal Arrangement (Bottom View)

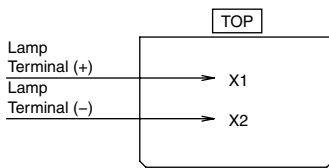

## Panel Cut-out for Positioning

Round (LBW6P/LBW6MP)

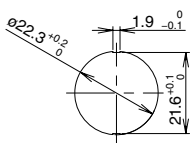

## Mounting Hole Layout

Round (LBW6P/LBW6MP)

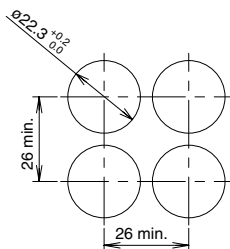

Square (LBW7P/LBW7MP)

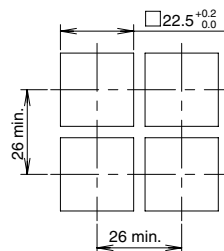

- For details on pc board and circuit design, see page 50.
- For details on single board mounting, see page 51.

Illuminated Pushbutton
Pilot Light
Pushbutton
Selector
Illuminated Selector
Key Selector
Lever Switch
Buzzer
Accessories
Maintenance Parts
Panel Cut-out
Instructions

# Flush Silhouette Switches LBW Series Pushbuttons

## Pushbuttons

Solder/Tab Terminal

Package Quantity: 1

Part No. / Shape	LBW①B-②1T③④*					
① Shape	Button Style	② Operation	③ Contact	Part No.		* Illumination Color Code
Black bezel	Button	Momentary	SPDT	LBW①B-M1T1*	LBW①B-M1T5*	Specify the color code in place of * in the Part No.  B: black G: green R: red S: blue W: white Y: yellow
			DPDT	LBW①B-M1T2*	LBW①B-M1T6*	
			3PDT	LBW①B-M1T3*	LBW①B-M1T7*	
		Maintained	SPDT	LBW①B-A1T1*	LBW①B-A1T5*	
			DPDT	LBW①B-A1T2*	LBW①B-A1T6*	
			3PDT	LBW①B-A1T3*	LBW①B-A1T7*	
Metallic bezel	Button	Momentary	SPDT	LBW①B-M1T1*	LBW①B-M1T5*	
			DPDT	LBW①B-M1T2*	LBW①B-M1T6*	
			3PDT	LBW①B-M1T3*	LBW①B-M1T7*	
		Maintained	SPDT	LBW①B-A1T1*	LBW①B-A1T5*	
			DPDT	LBW①B-A1T2*	LBW①B-A1T6*	
			3PDT	LBW①B-A1T3*	LBW①B-A1T7*	
Guard Type	Button	Momentary	SPDT	LBW①B-M1T1*	LBW①B-M1T5*	
			DPDT	LBW①B-M1T2*	LBW①B-M1T6*	
			3PDT	LBW①B-M1T3*	LBW①B-M1T6*	
		Maintained	SPDT	LBW①B-A1T1*	LBW①B-A1T5*	
			DPDT	LBW①B-A1T2*	LBW①B-A1T6*	
			3PDT	LBW①B-A1T3*	LBW①B-A1T7*	

- The guard opens 180 degrees spring-return.
- PC board terminals available for gold contacts. To specify, see Part Number Development below.
- Pushbuttons can be used with legend markings engraved on marking plates and lens buttons with clear film inserted in the lens is available. To specify, see Part Number Development below. See page 63 for details on the marking plate and film.
- Extended pushbuttons available. To specify, see Part Number Development below. Pushbuttons with guard is not available. Extended pushbuttons is available with momentary operation only.
- Other bezel sizes available (LB series). For details, see page 12.

## Part Number Development

### LBW①B-②③1T④⑤\*

#### ① Shape

Code	Shape
6	Round / Black Bezel
7	Square / Black Bezel
6M	Round / Metallic Bezel
7M	Square / Metallic Bezel
6G	Round with Guard
7G	Square with Guard

#### ② Operation

Code	Operation
A	Maintained
M	Momentary

#### ③ Operator Style

Code	Operation
1	Flush
2	Extended *

\* Extended style is available only for round (black/metallic bezel) and in momentary operation. Guard model is not available.

#### ④ Contacts

Code	Contact	Code	Contact
1	Gold/SPDT	5	Silver/SPDT
2	Gold/DPDT	6	Silver/DPDT
3	Gold/3PDT	7	Silver/3PDT

#### ⑤ Others

Code	Specification	Part No. Example
Blank	Solder/Tab Terminal	—
L (Note 1)	Lens	LBW6B-M1T1L*
V	PC Board Terminal (Gold Contact Only)	LB6WB-M1T1V*
VL (Note 1)	PC Board Terminal with Lens (Gold Contact Only)	LB6WB-M1T1VL*

Note 1: Codes L and VL are available with flush operator only.

- Color code (\*) for lens:  
A (amber), B (translucent lens with black nameplate), G (green), R (red), S (blue), W (white), Y (yellow)

# Flush Silhouette Switches LBW Series Pushbuttons

## Dimensions

Flush Silhouette  
LB Series

Flush Silhouette  
LBW Series

ø16  
LB Series

UP Series

All dimensions in mm.

### Flush Pushbutton

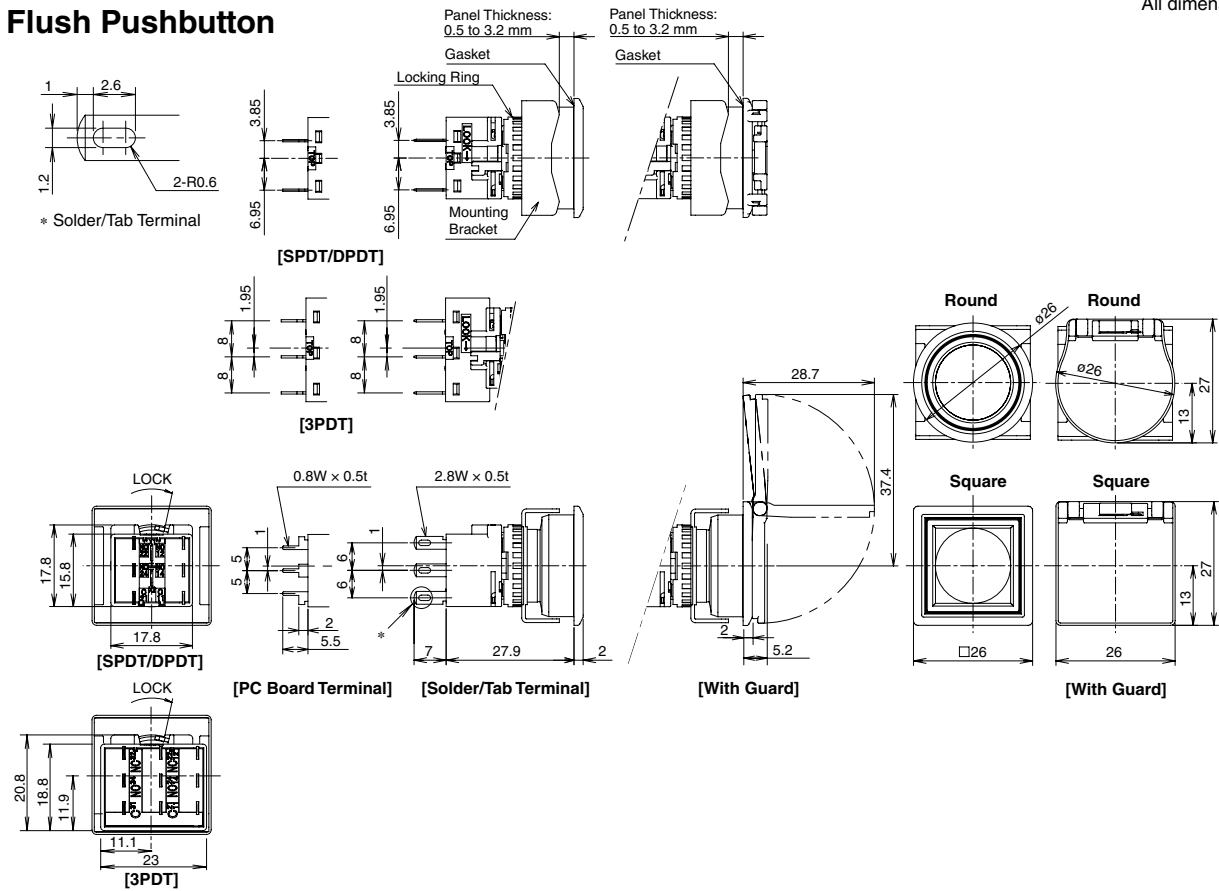

### Extended Pushbutton

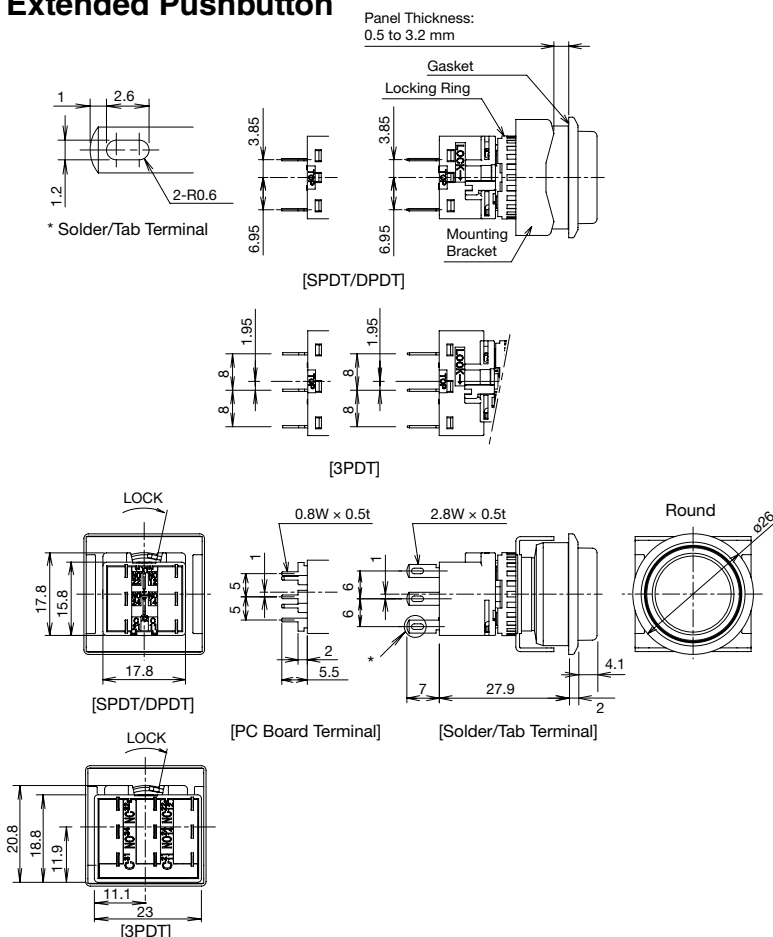

### Terminal Arrangement (Bottom View)

#### SPDT/DPDT Contacts

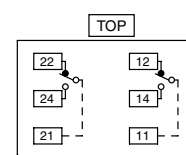

(SPDT contacts on the right only)

#### 3PDT Contacts

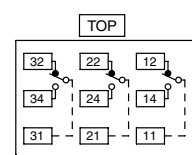

- For details on mounting hole layout, see page 49.
- For details on pc board and circuit design, see page 50.
- For details on single board mounting, see page 51.

Illuminated Pushbutton

Pilot Light

Pushbutton

Selector

Illuminated Selector

Key Selector

Lever Switch

Buzzer

Accessories

Maintenance Parts

Panel Cut-out



Instructions

# Flush Silhouette Switches LBW series Selector Switches

## Selector Switches

Solder/Tab Terminal

Package Quantity: 1

Part No. / Shape	<b>LBW</b> ① <b>S</b> -② <b>T</b> ③ ④	
		
	<p>Round / Black Bezel      Square / Black Bezel      Round / Metallic Bezel      Square / Metallic Bezel</p>	

① Shape	② Operator Position	③ Contact	Part No.		
			Gold Contact	Silver Contact	
Black bezel	90° 2-position	Maintained	SPDT	<b>LBW</b> ① <b>S</b> -2 <b>T</b> 1	<b>LBW</b> ① <b>S</b> -2 <b>T</b> 5
			DPDT	<b>LBW</b> ① <b>S</b> -2 <b>T</b> 2	<b>LBW</b> ① <b>S</b> -2 <b>T</b> 6
			3PDT	<b>LBW</b> ① <b>S</b> -2 <b>T</b> 3	<b>LBW</b> ① <b>S</b> -2 <b>T</b> 7
	45° 3-position	Maintained	DPDT	<b>LBW</b> ① <b>S</b> -3 <b>T</b> 2	<b>LBW</b> ① <b>S</b> -3 <b>T</b> 6
			3PDT	<b>LBW</b> ① <b>S</b> -3 <b>T</b> 3	<b>LBW</b> ① <b>S</b> -3 <b>T</b> 7
		Spring return two-way	DPDT	<b>LBW</b> ① <b>S</b> -3 <b>3T</b> 2	<b>LBW</b> ① <b>S</b> -3 <b>3T</b> 6
Metallic bezel	90° 2-position	Maintained	SPDT	<b>LBW</b> ① <b>S</b> -2 <b>T</b> 1	<b>LBW</b> ① <b>S</b> -2 <b>T</b> 5
			DPDT	<b>LBW</b> ① <b>S</b> -2 <b>T</b> 2	<b>LBW</b> ① <b>S</b> -2 <b>T</b> 6
			3PDT	<b>LBW</b> ① <b>S</b> -2 <b>T</b> 3	<b>LBW</b> ① <b>S</b> -2 <b>T</b> 7
	45° 3-position	Maintained	DPDT	<b>LBW</b> ① <b>S</b> -3 <b>T</b> 2	<b>LBW</b> ① <b>S</b> -3 <b>T</b> 6
			3PDT	<b>LBW</b> ① <b>S</b> -3 <b>T</b> 3	<b>LBW</b> ① <b>S</b> -3 <b>T</b> 7
		Spring return two-way	DPDT	<b>LBW</b> ① <b>S</b> -3 <b>3T</b> 2	<b>LBW</b> ① <b>S</b> -3 <b>3T</b> 6
		DPDT	<b>LBW</b> ① <b>S</b> -3 <b>3T</b> 3	<b>LBW</b> ① <b>S</b> -3 <b>3T</b> 7	

- PC board terminals available for gold contacts. To specify, see Part Number Development below.
- For contact operation, see page 48.
- Other bezel sizes available (LB series). For details, see page 14.

## Part Number Development

### LBW ① S-② T ③ ④

#### ① Shape



Code	Shape
6	Round / Black Bezel
7	Square / Black Bezel
6M	Round / Metallic Bezel
7M	Square / Metallic Bezel

#### ② Operator Position

##### 2-position

Operator Position
2 Maintained

##### 3-position

Operator Position	
3 Maintained	33 Spring return two-way
	

#### ③ Contacts

Code	Contact
1	Gold/SPDT (90° 2-position only)
2	Gold/DPDT
3	Gold/3PDT
5	Silver/SPDT (90° 2-position only)
6	Silver/DPDT
7	Silver/3PDT

#### ④ Others

Code	Specification	Part No. Example
Blank	Solder/Tab Terminal	—
V	PC Board Terminal (Gold Contact Only)	LBW6S-2T1V

# Flush Silhouette Switches LBW Series Selector Switches

Flush Silhouette LB Series
Flush Silhouette LBW Series
ø16 LB Series
UP Series

## Dimensions

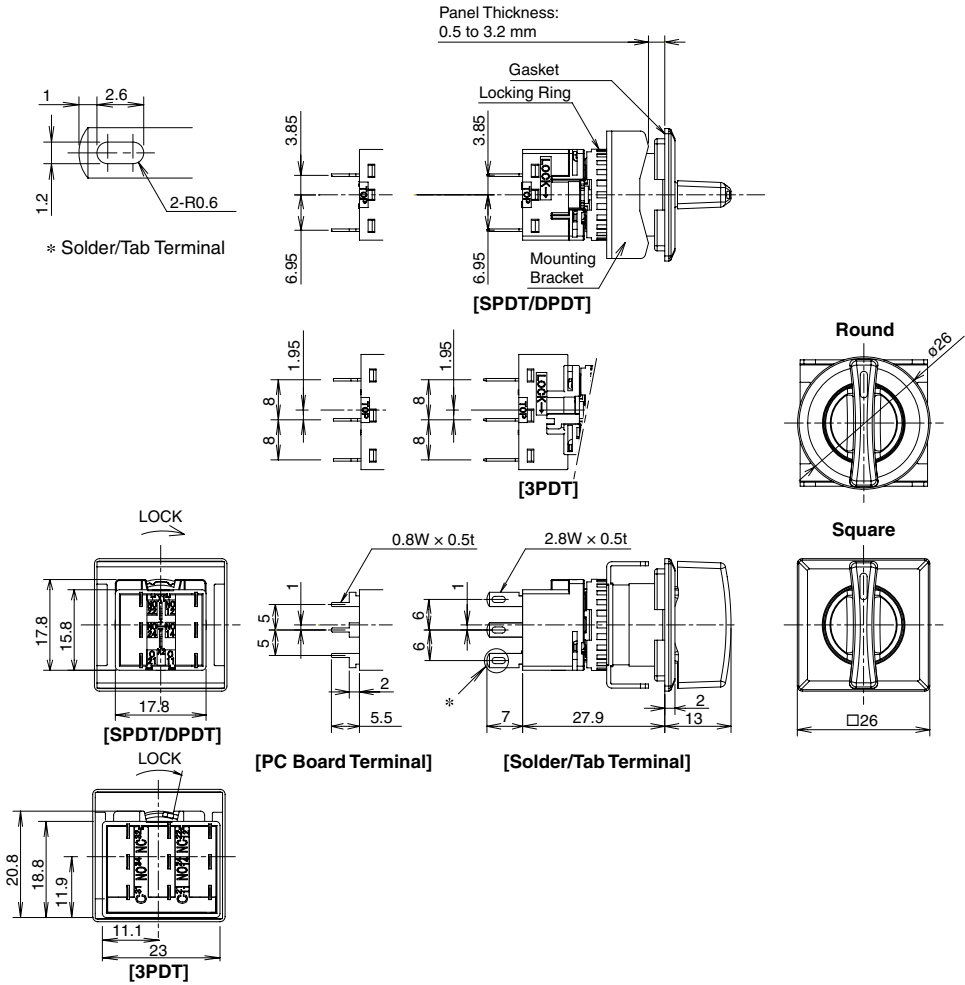

All dimensions in mm.

## Terminal Arrangement (Bottom View)

SPDT/DPDT Contacts

3PDT Contacts

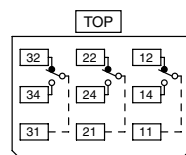
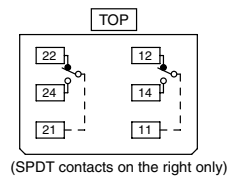

## Panel Cut-out for Positioning

Round (LBW6S/LBW6MS)

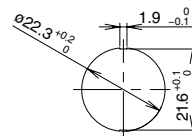

## Mounting Hole Layout

Round (LBW6S/LBW6MS)

Square (LBW7S/LBW7MS)

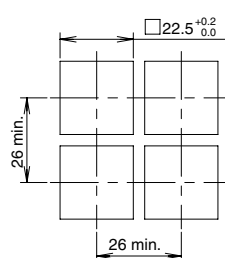
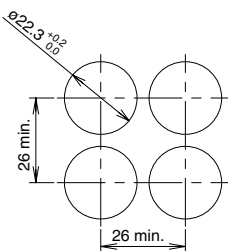

- For details on pc board and circuit design, see page 50.
- For details on single board mounting, see page 51.

Illuminated Pushbutton
Pilot Light
Pushbutton
<b>Selector</b>
Illuminated Selector
Key Selector
Lever Switch
Buzzer
Accessories
Maintenance Parts
Panel Cut-out
Instructions

# Flush Silhouette Switches LBW series Key Selector Switches

## Key Selector Switches

Solder/Tab Terminal

Package Quantity:1

Part No. / Shape	<b>LBW</b> ① <b>K</b> -② ③ <b>T</b> ④ ⑤ -⑥						
	Wave Key Disc Tumbler Key						
	Round / Black Bezel	Square / Black Bezel	Round / Metallic Bezel	Square / Metallic Bezel	Round / Metallic Bezel	Square / Metallic Bezel	
① Shape	② Operator Position		⑤ Key Removable Position	⑤ Contact	Part No.		
					Gold Contact	Silver Contact	
Black bezel	90° 2-position	Maintained	A: Key removable in all positions 	SPDT	<b>LBW</b> ① <b>K</b> -2 <b>ST</b> 1 <b>A</b>	<b>LBW</b> ① <b>K</b> -2 <b>ST</b> 5 <b>A</b>	
				DPDT	<b>LBW</b> ① <b>K</b> -2 <b>ST</b> 2 <b>A</b>	<b>LBW</b> ① <b>K</b> -2 <b>ST</b> 6 <b>A</b>	
	45° 3-position	Maintained		DPDT	<b>LBW</b> ① <b>K</b> -3 <b>ST</b> 2 <b>A</b>	<b>LBW</b> ① <b>K</b> -3 <b>ST</b> 6 <b>A</b>	
				3PDT	<b>LBW</b> ① <b>K</b> -3 <b>ST</b> 3 <b>A</b>	<b>LBW</b> ① <b>K</b> -3 <b>ST</b> 7 <b>A</b>	
Metallic bezel	90° 2-position	Maintained	A: Key removable in all positions 	SPDT	<b>LBW</b> ① <b>K</b> -2 <b>ST</b> 1 <b>A</b>	<b>LBW</b> ① <b>K</b> -2 <b>ST</b> 5 <b>A</b>	
				DPDT	<b>LBW</b> ① <b>K</b> -2 <b>ST</b> 2 <b>A</b>	<b>LBW</b> ① <b>K</b> -2 <b>ST</b> 6 <b>A</b>	
	45° 3-position	Maintained		DPDT	<b>LBW</b> ① <b>K</b> -3 <b>ST</b> 2 <b>A</b>	<b>LBW</b> ① <b>K</b> -3 <b>ST</b> 6 <b>A</b>	
				3PDT	<b>LBW</b> ① <b>K</b> -3 <b>ST</b> 3 <b>A</b>	<b>LBW</b> ① <b>K</b> -3 <b>ST</b> 7 <b>A</b>	

- For operator position, see Part Number Development below.
- For key removable position, see Part Number Development below. The key cannot be removed at the return position.
- Two keys are supplied.
- Besides the standard key (key number 0H), six other keys are available.
- Disc tumbler keys also available. Only the standard key is available. To specify, see Part Number Development below.
- PC board terminals available for gold contacts. To specify, see Part Number Development below.
- For contact operation, see page 48.
- Other bezel sizes available (LB series). For details, see page 18.

## Part Number Development

### LBW ① K-② ③ T④ ⑤ -⑥

#### ① Shape

Code	Shape
6	Round / Black Bezel
7	Square / Black Bezel
6M	Round / Metallic Bezel
7M	Square / Metallic Bezel

#### ② Operator Position

Code	Operator Position
2	90° 2-position maintained
3	45° 3-position maintained
33	45°-3-position spring return two-way

#### ③ Key Style

Code	Key Style
S	Wave key
Blank	Disc tumbler key

#### ④ Contacts

Code	Contact
1	Gold/SPDT (90° 2-position only)
2	Gold/DPDT
3	Gold/3PDT
5	Silver/SPDT (90° 2-position only)
6	Silver/DPDT
7	Silver/3PDT

#### ⑤ Key Removal Position

The key cannot be removed at the return position.

##### 2-position

Key Removable Position	
A: Key removable in all positions 	B: Key removable at left 

##### 3-position

Key Removable Position	
A: Key removable in all positions 	D: Key removable at center 

##### 3-position

Spring return two-way

- Key is removable at ①, ③, ④, ⑤.
- Key is retained at ②, ⑥, and ⑦.

#### ⑥ Key Number

Code	Key Number
0H	Standard key
1H to 2H	Reversible key
3H to 6H	Non-reversible key

- Wave keys only.

#### Others

Code	Specification	Part No. Example
Blank	Solder/Tab Terminal	—
V	PC Board Terminal (Gold Contact Only)	LBW6K-2T1VA



# Flush Silhouette Switches LBW Series Key Selector Switches

Flush Silhouette  
LB Series

Flush Silhouette  
LBW Series

ø16  
LB Series

UP Series

## Dimensions

### Key Selector Switches with Wave Key

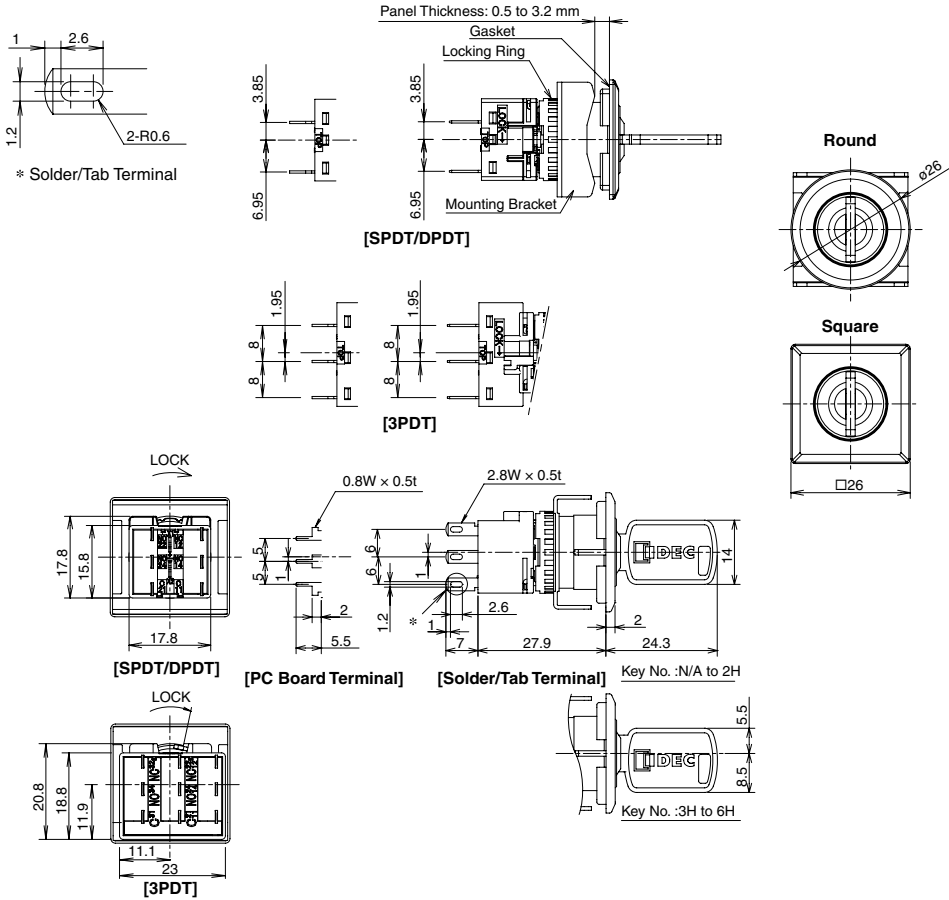

### Key Selector Switches with Disc Tumbler Key

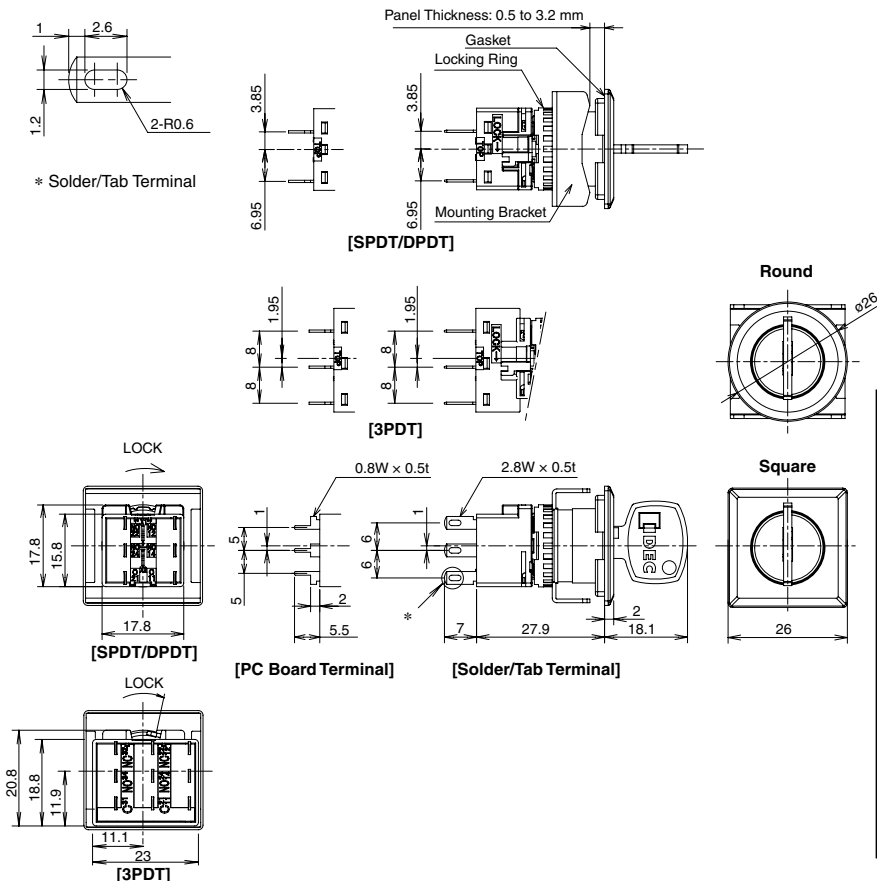

### Terminal Arrangement (Bottom View)

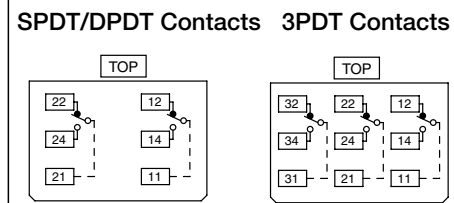

- (SPDT contacts on the right only)
- For details on mounting hole layout, see page 49.
  - For details on pc board and circuit design, see page 50.
  - For details on single board mounting, see page 51.





Illuminated Pushbutton
Pilot Light
Pushbutton
Selector
Illuminated Selector
<b>Key Selector</b>
Lever Switch
Buzzer
Accessories
Maintenance Parts
Panel Cut-out
Instructions

# ø16 LB Series Illuminated Pushbuttons

## Illuminated Pushbuttons

Solder/Tab Terminal

Package Quantity: 1

Part No. / Shape	LB ① L-② 1T ③ ④ ⑤ *					
	 Round		 Square		 Rectangular	
				 Rectangular with 3-sided Barrier		
② Operation	③ Contact	④ LED Operating Voltage	Part No.		* Illumination Color Code	
			Gold Contact	Silver Contact		
Momentary	SPDT	24V AC/DC	LB①L-M1T14*	LB①L-M1T54*	Specify the color code in place of * in the Part No. A: amber G: green PW: pure white R: red S: blue W: white Y: yellow	
	DPDT		LB①L-M1T24*	LB①L-M1T64*		
Maintained	SPDT	24V AC/DC	LB①L-A1T14*	LB①L-A1T54*		
	DPDT		LB①L-A1T24*	LB①L-A1T64*		

- Illuminated pushbuttons contain an LED unit. For details on LED units, see page 60.
- Illuminated pushbuttons can be used with legend markings. Engraving can be done on a marking plate which is placed in the lens, or a clear film can be printed and placed in the lens. See page 63 for details on the marking plate and film.
- White lens type (when light is off) are available. Clear lens is used instead of colored lens for amber, green, red, and blue illuminated pushbuttons. Amber, green, red, or blue LED units are used. To specify, see Part Number Development below.
- PC board terminals available for gold contacts. To specify, see Part Number Development below.
- 5V DC and 12V AC/DC LED operating voltages also available. To specify, see Part Number Development below.

## Part Number Development

LB ① L-② 1T ③ ④ ⑤ \*

### ① Shape

Code	Shape
1	Round
2	Square
3	Rectangular
4	Rectangular with 3-sided Barrier

### ② Operation

Code	Operation
A	Maintained
M	Momentary

### ③ Contacts

Code	Contact
1	Gold/SPDT
2	Gold/DPDT
5	Silver/SPDT
6	Silver/DPDT

### ④ LED Operating Voltage

Code	Rated Operating Voltage
1	5V DC
3	12V AC/DC
4	24V AC/DC

### ⑤ Others

Code	Specification	Part No. Example
Blank	Solder/Tab Terminal	—
W	White Lens Type (When Light is Off)	LB1L-M1T14W*
V	PC Board Terminal (Gold Contact Only)	LB1L-M1T14V*
VW	White Lens Type (When Light is Off) with PC Board Terminal (Gold Contact Only)	LB1L-M1T14VW*

- Specify the color code in place of \* in the table above
- Color code for white lens type: A (amber), G (green), R (red), and S (blue) only.

Flush Silhouette LB Series
Flush Silhouette LBW Series
<b>ø16 LB Series</b>
UP Series

## Dimensions

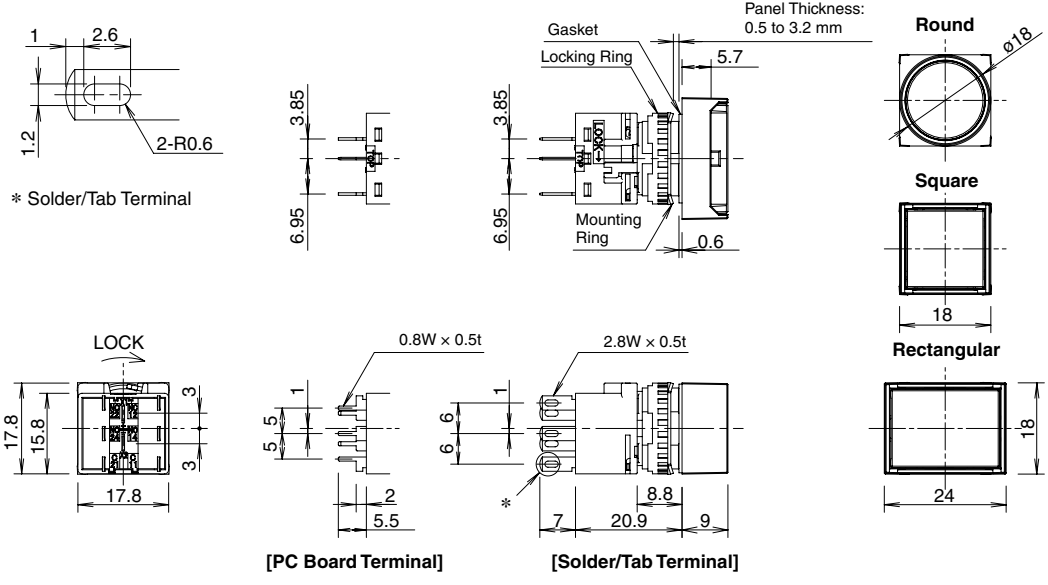

All dimensions in mm.

### Terminal Arrangement (Bottom View)

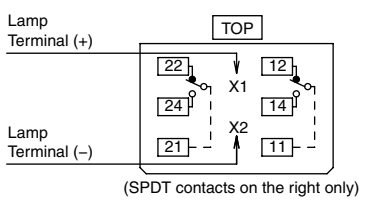

### Panel Cut-out for Positioning (LB1L/LB2L/LB3L/LB4L)

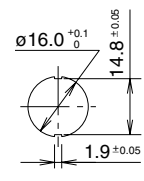

### Mounting Hole Layout (LB1L/LB2L/LB3L/LB4L)

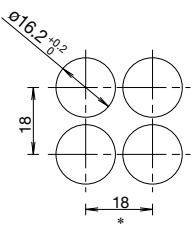

\*: 24 mm for rectangular units.  
 Note: When using rubber boot or terminal cover, see dimensions on 56 and 58.

- For details on pc board and circuit design, see page 50.
- For details on single board mounting, see page 51.



<b>Illuminated Pushbutton</b>
Pilot Light
Pushbutton
Selector
Illuminated Selector
Key Selector
Lever Switch
Buzzer
Accessories
Maintenance Parts
Panel Cut-out
Instructions

# ø16 LB Series Pilot Lights

## Pilot Lights

Solder/Tab Terminal

Package Quantity: 1

Part No. / Shape	LB①P-②T③④*					
						
② Lens Shape	③ LED Operating Voltage	Part No.	* Illumination Color Code			
Flush	24V AC/DC	LB①P-1T04*	Specify the color code in place of * in the Part No. A: amber G: green PW: pure white R: red S: blue W: white Y: yellow			
Dome	24V AC/DC	LB1P-2T04*				

- Pilot lights contain an LED unit. For maintenance LED units see page 60.
- Legends and symbols can be engraved on a marking plate or film to be inserted under the lens by users for labelling purposes. See page 63 for details.
- White lens type (when light is off) are available. Clear lens is used instead of colored lens for amber, green, red, and blue pilot lights. Amber, green, red, or blue LED units are used. To specify, see Part Number Development below.
- PC board terminals available. To specify, see Part Number Development below.
- 5V DC and 12V AC/DC LED operating voltages also available. To specify, see Part Number Development below.

### Part Number Development

#### LB①P-②T③④\*

##### ① Shape

Code	Shape
1	Round
2	Square
3	Rectangular
4	Rectangular with 3-sided Barrier

##### ② Lens Shape

Code	Lens Shape
1	Flush
2	Dome

##### ③ LED Operating Voltage

Code	Rated Operating Voltage
1	5V DC
3	12V AC/DC
4	24V AC/DC

- Round only for dome.

##### ④ Others

Code	Specification	Part No. Example
Blank	Solder/Tab Terminal	—
W	White Lens Type (When Light is Off)	LB1P-1T04W*
V	PC Board Terminal	LB1P-1T04V*
VW	White Lens Type (When light is Off) with PC Board Terminal	LB1P-1T04VW*

- Specify the color code in place of \* in the table above
- Color code for white lens type: A (amber), G (green), R (red), and S (blue) only.

Flush Silhouette LB Series
Flush Silhouette LBW Series
<b>ø16 LB Series</b>
UP Series

## Dimensions

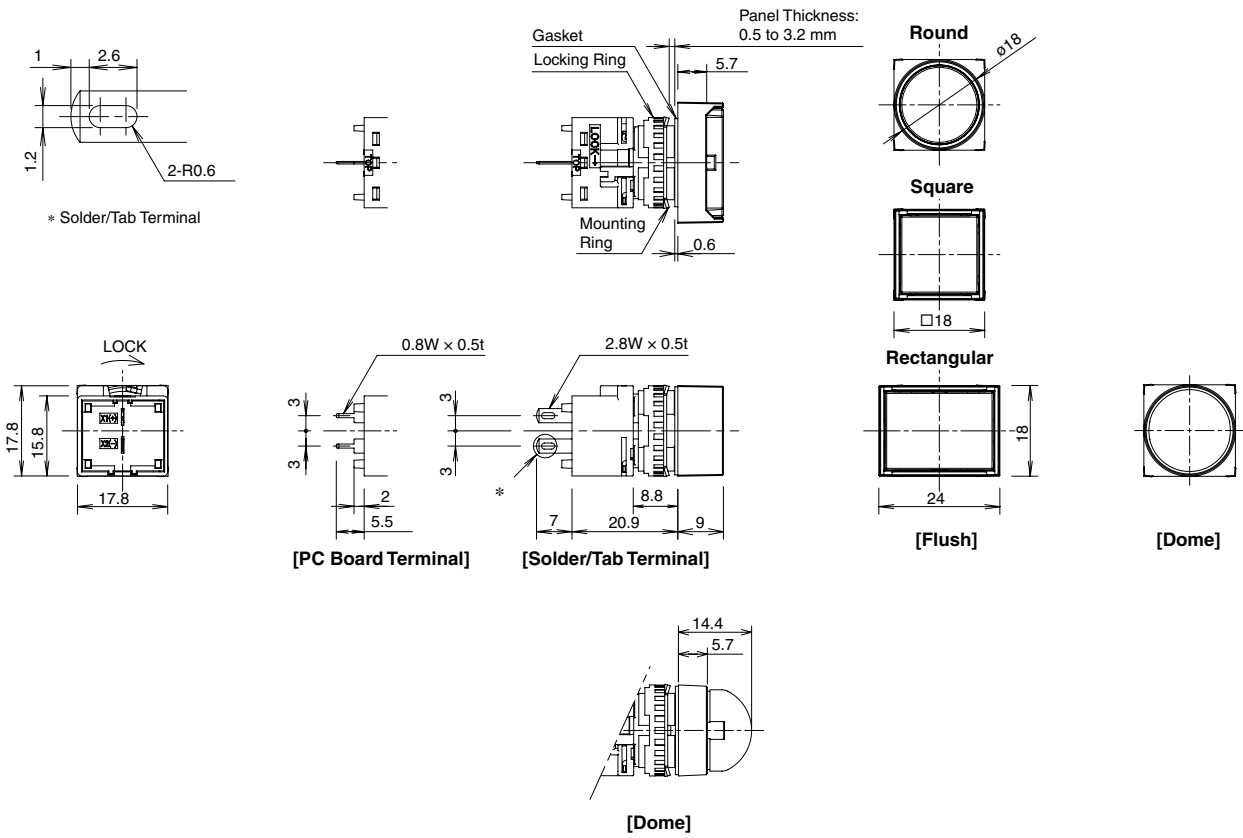

All dimensions in mm.

### Terminal Arrangement (Bottom View)

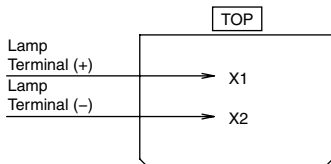

### Panel Cut-out for Positioning (LB1P/LB2P/LB3P/LB4P)

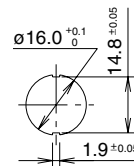

### Mounting Hole Layout

(LB1P/LB2P/LB3P/LB4P)

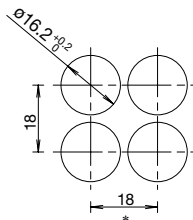

\*: 24 mm for rectangular units.  
 Note: When using rubber boot or terminal cover, see dimensions on 56 and 58.

- For details on pc board and circuit design, see page 50.
- For details on single board mounting, see page 51.



Illuminated Pushbutton
<b>Pilot Light</b>
Pushbutton
Selector
Illuminated Selector
Key Selector
Lever Switch
Buzzer
Accessories
Maintenance Parts
Panel Cut-out
Instructions

# ø16 LB Series Pushbuttons

## Pushbuttons

Solder/Tab Terminal

Package Quantity: 1

Part No. / Shape	<b>LB</b> ① <b>B</b> -② <b>1T</b> ③④*	
		
	<span>Round</span> <span>Square</span> <span>Rectangular</span> <span>Rectangular with 3-sided Barrier</span>	

Button Style	② Operation	③ Contact	Part No.		* Illumination Color Code
			Gold Contact	Silver Contact	
Button	Momentary	SPDT	<b>LB</b> ① <b>B</b> - <b>M1T1</b> *	<b>LB</b> ① <b>B</b> - <b>M1T5</b> *	B: black G: green R: red S: blue W: white Y: yellow
		DPDT	<b>LB</b> ① <b>B</b> - <b>M1T2</b> *	<b>LB</b> ① <b>B</b> - <b>M1T6</b> *	
		3PDT	<b>LB</b> ① <b>B</b> - <b>M1T3</b> *	<b>LB</b> ① <b>B</b> - <b>M1T7</b> *	
	Maintained	SPDT	<b>LB</b> ① <b>B</b> - <b>A1T1</b> *	<b>LB</b> ① <b>B</b> - <b>A1T5</b> *	
		DPDT	<b>LB</b> ① <b>B</b> - <b>A1T2</b> *	<b>LB</b> ① <b>B</b> - <b>A1T6</b> *	
		3PDT	<b>LB</b> ① <b>B</b> - <b>A1T3</b> *	<b>LB</b> ① <b>B</b> - <b>A1T7</b> *	
Lens	Momentary	SPDT	<b>LB</b> ① <b>B</b> - <b>M1T1L</b> *	<b>LB</b> ① <b>B</b> - <b>M1T5L</b> *	A: amber G: green R: red S: blue W: white Y: yellow
		DPDT	<b>LB</b> ① <b>B</b> - <b>M1T2L</b> *	<b>LB</b> ① <b>B</b> - <b>M1T6L</b> *	
		3PDT	<b>LB</b> ① <b>B</b> - <b>M1T3L</b> *	<b>LB</b> ① <b>B</b> - <b>M1T7L</b> *	
	Maintained	SPDT	<b>LB</b> ① <b>B</b> - <b>A1T1L</b> *	<b>LB</b> ① <b>B</b> - <b>A1T5L</b> *	
		DPDT	<b>LB</b> ① <b>B</b> - <b>A1T2L</b> *	<b>LB</b> ① <b>B</b> - <b>A1T6L</b> *	
		3PDT	<b>LB</b> ① <b>B</b> - <b>A1T3L</b> *	<b>LB</b> ① <b>B</b> - <b>A1T7L</b> *	

- Lens can be used with legend markings. Engraving can be done on a marking plate which is placed in the lens, or a clear film can be printed and placed in the lens. See page 63 for details on the marking plate and film.
- Black is available for lens. Black lens consists of a transparent lens and a black marking plate. To specify, see Part Number Development below.
- PC board terminals available for gold contacts. To specify, see Part Number Development below.

## Part Number Development

### LB

①**B**-②**1T**③④\*

#### ① Shape

Code	Shape
1	Round
2	Square
3	Rectangular
4	Rectangular with 3-sided Barrier

#### ② Operation

Code	Operation
A	Maintained
M	Momentary

#### ③ Contacts

Code	Contact
1	Gold/SPDT
2	Gold/DPDT
3	Gold/3PDT
5	Silver/SPDT
6	Silver/DPDT
7	Silver/3PDT

#### ④ Others

Code	Specification	Part No. Example
Blank	Solder/Tab Terminal	—
B	Black Translucent Lens (Lens Only)	LB1B-M1T1L <b>B</b>
V	PC Board Terminal (Gold Contact Only)	LB1B-M1T1V*

Flush Silhouette LB Series
Flush Silhouette LBW Series
<b>ø16 LB Series</b>
UP Series

## Dimensions

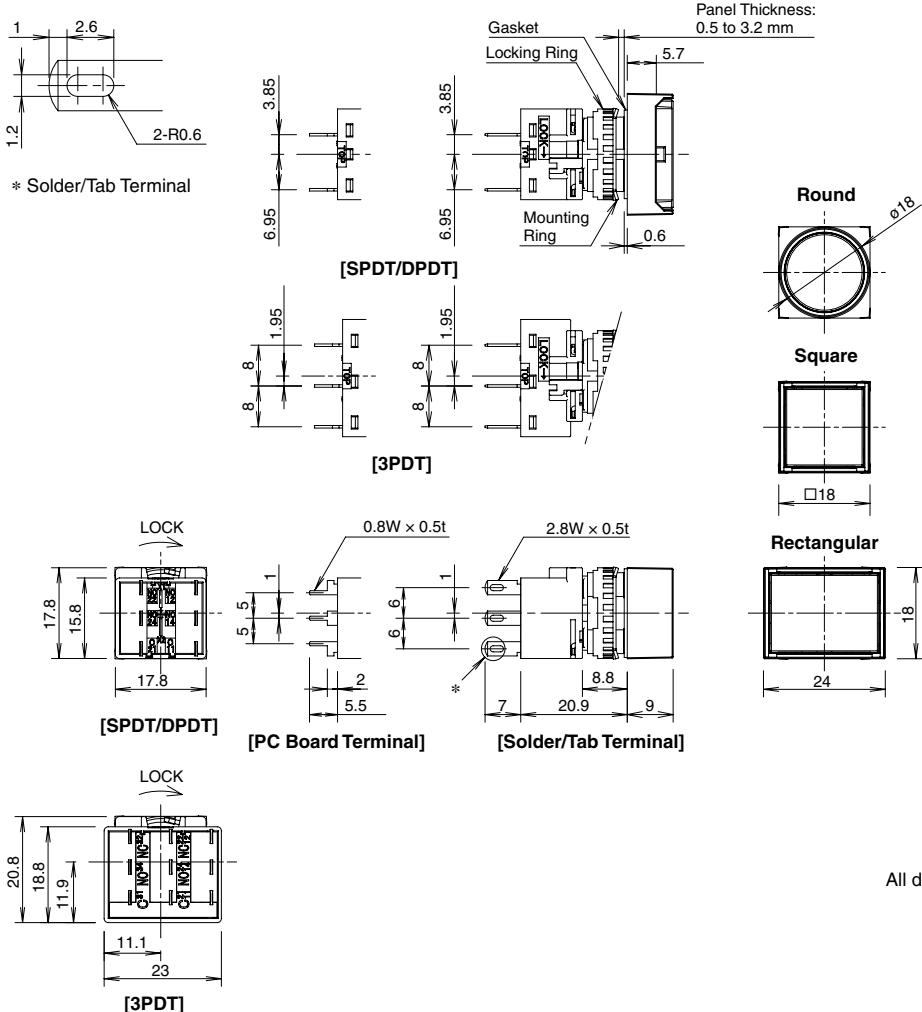

All dimensions in mm.

Illuminated Pushbutton
Pilot Light
<b>Pushbutton</b>
Selector
Illuminated Selector
Key Selector
Lever Switch
Buzzer
Accessories
Maintenance Parts
Panel Cut-out
Instructions

### Terminal Arrangement (Bottom View)

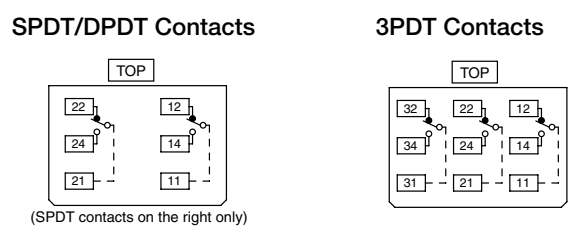

### Mounting Hole Layout (LB1B/LB2B/LB3B/LB4B)

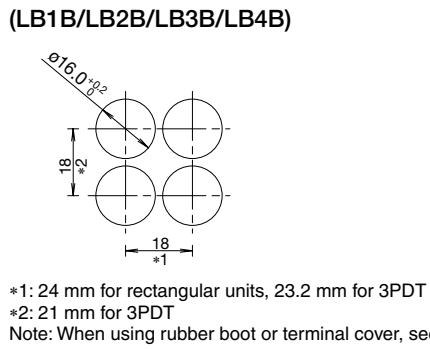

### Panel Cut-out for Positioning (LB1B/LB2B/LB3B/LB4B)

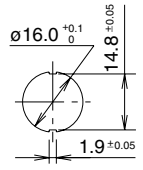

- For details on pc board and circuit design, see page 50.
- For details on single board mounting, see page 51.

# ø16 LB Series Selector Switches

## Selector Switches

Solder/Tab Terminal

Package Quantity: 1

Part No. / Shape	<b>LB</b> ① <b>S</b> -② ③ <b>T</b> ④ ⑤							
	Knob Operator			Lever Operator				
	Round	Square	Rectangular	Round	Square	Rectangular		
② Operator Position			③ Contact	Part No.				
				Gold Contact	Silver Contact			
90° 2-position	Maintained		SPDT	<b>LB</b> ① <b>S</b> -2 <b>T</b> 1	<b>LB</b> ① <b>S</b> -2 <b>T</b> 5			
			DPDT	<b>LB</b> ① <b>S</b> -2 <b>T</b> 2	<b>LB</b> ① <b>S</b> -2 <b>T</b> 6			
			3PDT	<b>LB</b> ① <b>S</b> -2 <b>T</b> 3	<b>LB</b> ① <b>S</b> -2 <b>T</b> 7			
45° 3-position	Maintained		DPDT	<b>LB</b> ① <b>S</b> -3 <b>T</b> 2	<b>LB</b> ① <b>S</b> -3 <b>T</b> 6			
			3PDT	<b>LB</b> ① <b>S</b> -3 <b>T</b> 3	<b>LB</b> ① <b>S</b> -3 <b>T</b> 7			
	Spring return two-way		DPDT	<b>LB</b> ① <b>S</b> -3 <b>T</b> 2	<b>LB</b> ① <b>S</b> -3 <b>T</b> 6			
			3PDT	<b>LB</b> ① <b>S</b> -3 <b>T</b> 3	<b>LB</b> ① <b>S</b> -3 <b>T</b> 7			

- Lever operators also available. To specify, see Part Number Development below.
- PC board terminals available for gold contacts. To specify, see Part Number Development below.
- 2-position spring return from right, 3-position spring return from right, 3-position spring return from left also available. To specify, see Part Number Development below.
- For contact operation, see page 48.

## Part Number Development

### LB ① S-② ③ T④ ⑤

#### ① Shape

Code	Shape
1	Round
2	Square
3	Rectangular

#### ② Operator Position

2-position	
Operator Position	
<b>2</b> Maintained	<b>21</b> Spring return from right

#### 3-position

Operator Position			
<b>3</b> Maintained	<b>31</b> Spring return from right	<b>32</b> Spring return from left	<b>33</b> Spring return two-way

#### ③ Operator

Code	Operator Shape
Blank	Knob
L	Lever

#### ④ Contacts

Code	Contact
1	Gold/SPDT (90° 2-position only)
2	Gold/DPDT
3	Gold/3PDT
5	Silver/SPDT (90° 2-position only)
6	Silver/DPDT
7	Silver/3PDT

#### ⑤ Others

Code	Specification	Part No. Example
Blank	Solder/Tab Terminal	—
V	PC Board Terminal (Gold Contact Only)	LB1S-2T1V









# ø16 LB Series Illuminated Selector Switches

## Illuminated Selector Switches

Solder/Tab Terminal

Package Quantity: 1

Part No. / Shape	LB①F-②T③④⑤*					
				Round	Square	Rectangular

90° 2-position	② Operator Position Maintained 	③ Contact SPDT	④ LED Operating Voltage 24V AC/DC	Part No.		* Illumination Color Code
				Gold Contact	Silver Contact	
		DPDT	24V AC/DC	LB①F-2T14*	LB①F-2T54*	Specify the color code in place of * in the Part No. G: green R: red W: white
				LB①F-2T24*	LB①F-2T64*	
45° 3-position	Maintained 	DPDT	24V AC/DC	LB①F-3T24*	LB①F-3T64*	

- Illuminated selector switches contain an LED unit. For maintenance LED units see page 60.
- PC board terminals available for gold contacts. To specify, see Part Number Development below.
- 5V DC and 12V AC/DC LED operating voltages also available. To specify, see Part Number Development below.
- For contact operation, see page 48.



## Part Number Development

LB①F-②T③④⑤\*

### ① Shape

Code	Shape
1	Round
2	Square
3	Rectangular

### ② Operator Position

Operator Position	
2-position	3-position
2 Maintained 	3 Maintained 

### ③ Contacts

Code	Contact
1	Gold/SPDT (90° 2-position only)
2	Gold/DPDT
5	Silver/SPDT (90° 2-position only)
6	Silver/DPDT

### ④ LED Operating Voltage

Code	Rated Operating Voltage
1	5V DC
3	12V AC/DC
4	24V AC/DC

### ⑤ Others

Code	Specification	Part No. Example
Blank	Solder/Tab Terminal	—
V	PC Board Terminal (Gold Contact Only)	LB1F-2T14V*

- Specify a color code in place of \* in the Part No.

# LB Series Illuminated Selector Switches ø16

Flush Silhouette LB Series
Flush Silhouette LBW Series
<b>ø16 LB Series</b>
UP Series

## Dimensions

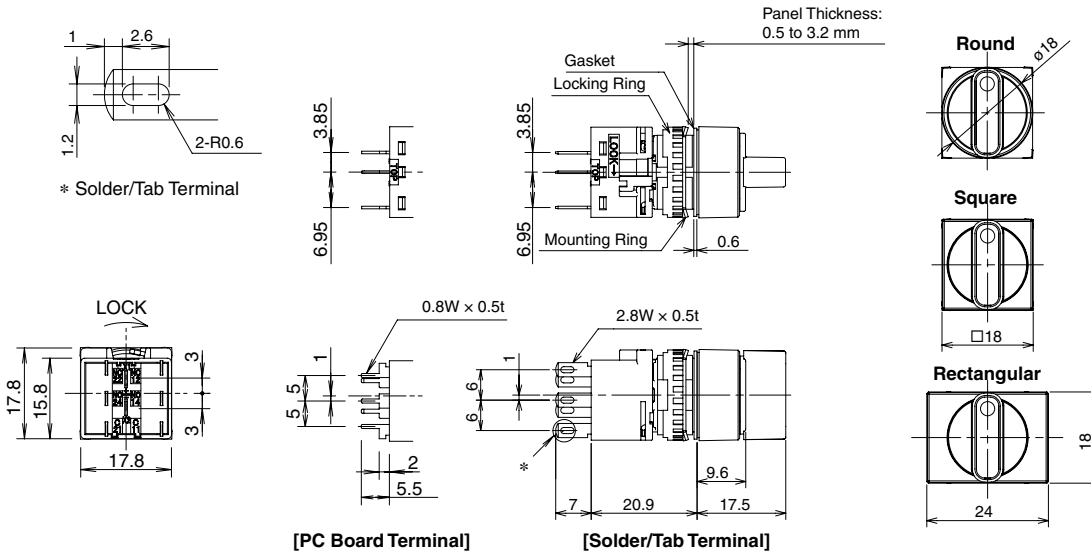

All dimensions in mm.

### Terminal Arrangement (Bottom View)

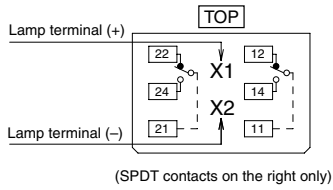

### Panel Cut-out for Positioning Round (LB1F/LB2F/LB3F)

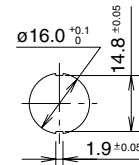

### Mounting Hole Layout

#### Round (LB1F/LB2F/LB3F)

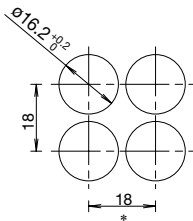

\*: 24 mm for rectangular units.

Note: When using terminal cover, see dimensions on page 58.

- For details on pc board and circuit design, see page 50.
- For details on single board mounting, see page 51.







Illuminated Pushbutton
Pilot Light
Pushbutton
Selector
<b>Illuminated Selector</b>
Key Selector
Lever Switch
Buzzer
Accessories
Maintenance Parts
Panel Cut-out
Instructions

# ø16 LB Series Key Selector Switches

## Key Selector Switches

Solder/Tab Terminal

Package Quantity: 1

Part No. / Shape	LB ① K-② ③ T ④ ⑤ -⑥				
			 Round	 Square	 Rectangular
② Operator Position		⑤ Key Removable Position	④ Contact	Part No.	
				Gold Contact	Silver Contact
90° 2-position	Maintained	A: Key removable in all positions 	SPDT	LB①K-2ST1A	LB①K-2ST5A
			DPDT	LB①K-2ST2A	LB①K-2ST6A
			3PDT	LB①K-2ST3A	LB①K-2ST7A
45° 3-position	Maintained	A: Key removable in all positions 	DPDT	LB①K-3ST2A	LB①K-3ST6A
			3PDT	LB①K-3ST3A	LB①K-3ST7A

- For operator position, see Part Number Development below.
- For key removable position, see Part Number Development below. The key cannot be removed at the return position.
- Two keys are supplied.
- Besides the standard key (key number 0H), six other keys are available.
- Disc tumbler keys also available. Only the standard key is available. To specify, see Part Number Development below.
- PC board terminals available for gold contacts. To specify, see Part Number Development below.
- For contact operation, see page 48.

### Part Number Development

#### LB ① K-② ③ T ④ ⑤ -⑥

##### ① Shape

Code	Shape
1	Round
2	Square
3	Rectangular

##### ② Operator Position

Code	Operator Position
2	90° 2-position maintained
21	90° 2-position spring return from right
3	45° 3-position maintained
31	45° 3-position spring return from right
32	45° 3-position spring return from left
33	45°-3-position spring return two-way

##### ③ Key Style

Code	Key Style
S	Wave key
Blank	Disc tumbler key

##### ⑥ Key Number

Code	Key Number
Blank	Standard key (0H)
1H to 2H	Reversible key
3H to 6H	Non-reversible key





- Wave key only.

##### ④ Contacts







Code	Contact
1	Gold/SPDT (90° 2-position only)
2	Gold/DPDT
3	Gold/3PDT
5	Silver/SPDT (90° 2-position only)
6	Silver/DPDT
7	Silver/3PDT

##### ⑤ Key Removal Position

###### 2-position



Key Removable Position			Spring return from right
A: Key removable in all positions 	B: Key removable at left 	C: Key removable at right 	

###### 3-position

Key Removable Position			
A: Key removable in all positions 	B: Key removable at left / center 	C: Key removable at center / right 	D: Key removable at center 
E: Key removable at right / left 	G: Key removable at left 	H: Key removable at right 	

For key selectors with the following operations, the key cannot be removed at the return position.

###### 3-position

Spring return from right	Spring return from left	Spring return two-way
		

- Key is removable at ①, ②, ③. Key is retained at ④, ⑤, and ⑥.

##### Others

Code	Specification	Part No. Example
Blank	Solder/Tab Terminal	—
V	PC Board Terminal (Gold Contact Only)	LB1K-2ST1VA

Flush Silhouette LB Series
Flush Silhouette LBW Series
<b>ø16 LB Series</b>
UP Series

## Dimensions

### Key Selector Switches with Wave Key

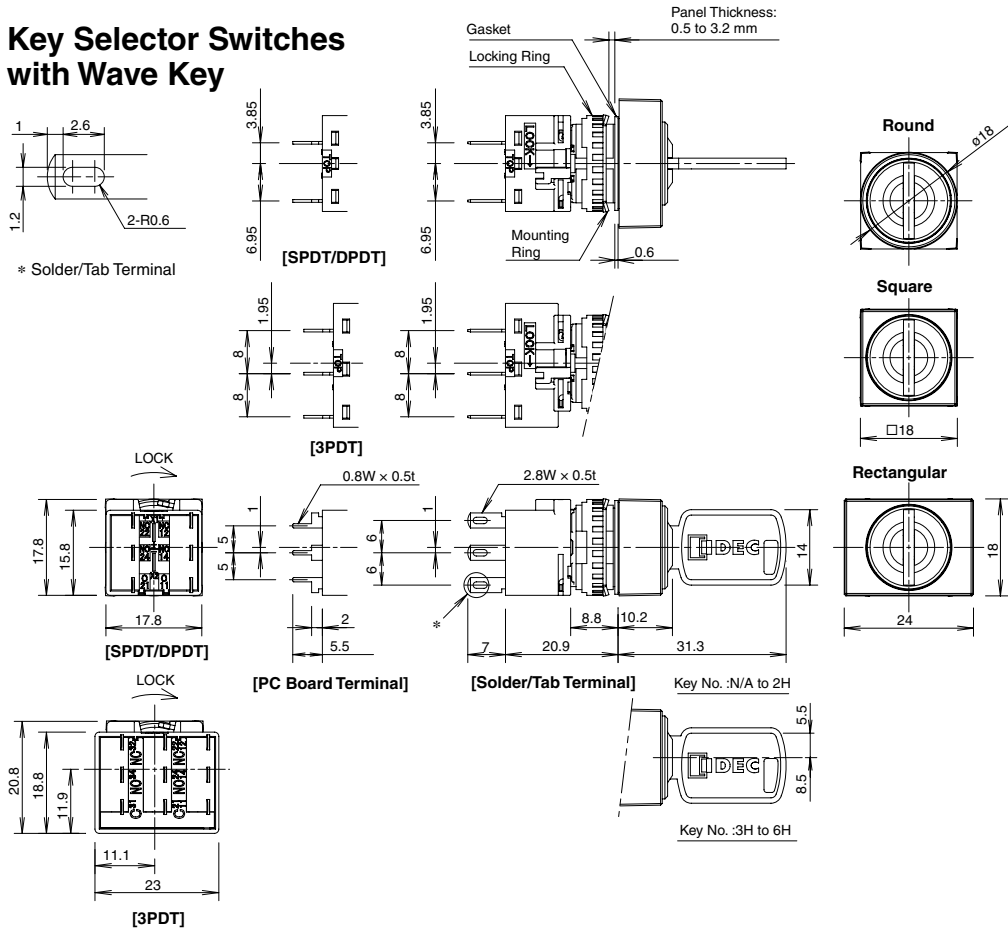

### Key Selector Switches with Disc Tumbler Key

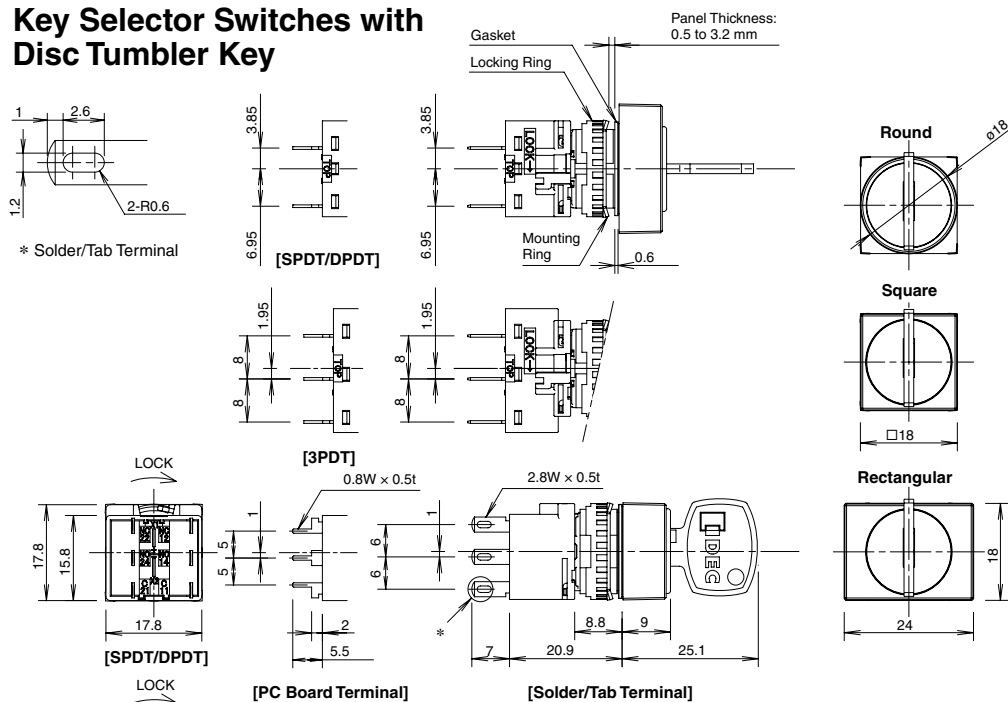

Illuminated Pushbutton
Pilot Light
Pushbutton
Selector
Illuminated Selector
<b>Key Selector</b>
Lever Switch
Buzzer
Accessories
Maintenance Parts
Panel Cut-out
Instructions

All dimensions in mm.

### Terminal Arrangement (Bottom View)

#### SPDT/DPDT Contacts

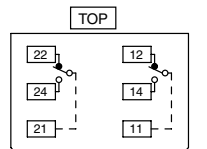

#### 3PDT Contacts

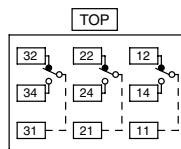





- For details on mounting hole layout, see page 49.
- For details on pc board and circuit design, see page 50.
- For details on single board mounting, see page 51.

# ø16 LB Series Lever Switches

## Lever Switches

Solder/Tab Terminal

Package Quantity: 1

Part No. / Shape					
		 Round			
Operator Position	Contact	Part No.			
		Gold Contact	Silver Contact		
2-position	Maintained		SPDT	<b>LB1T-2T1</b>	<b>LB1T-2T5</b>
			DPDT	<b>LB1T-2T2</b>	<b>LB1T-2T6</b>
			3PDT	<b>LB1T-2T3</b>	<b>LB1T-2T7</b>
3-position	Maintained		DPDT	<b>LB1T-3T2</b>	<b>LB1T-3T6</b>
			3PDT	<b>LB1T-3T3</b>	<b>LB1T-3T7</b>
	Spring return from top/bottom		DPDT	<b>LB1T-33T2</b>	<b>LB1T-33T6</b>
			3PDT	<b>LB1T-33T3</b>	<b>LB1T-33T7</b>

- PC board terminals available for gold contacts. Add "V" to the Part No.  
Example: **LB1T-2T1V**
- For contact operation, see page 48.

## Dimensions

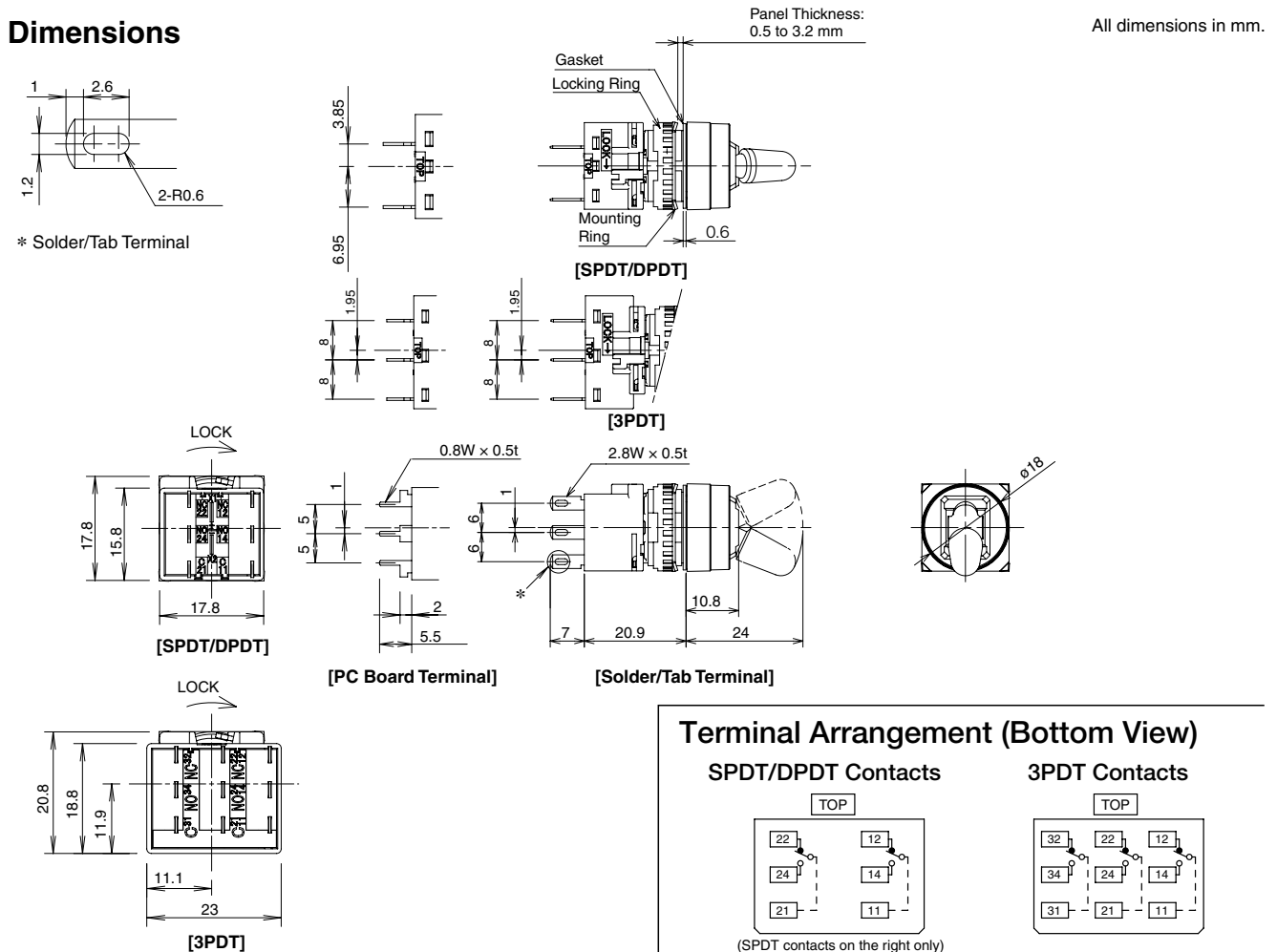



- For details on mounting hole layout, see page 49.
- For details on pc board and circuit design, see page 50.
- For details on single board mounting, see page 51.

## Buzzers

### Specifications

Rated Insulation Voltage	30V	Dielectric Strength	Between live and dead parts: 1,000V AC, 1 minute
Rated Operating Voltage	12, 24V DC	Vibration Resistance	Operating extremes/Damage limits: 5 to 55 Hz, amplitude 0.5 mm
Operating Voltage Range	12V DC±10%, 24V DC±10%	Shock Resistance	Operating extremes: 100m/s <sup>2</sup> Damage limits: 1,000m/s <sup>2</sup>
Current Draw	26mA	Life	1,000 hours minimum (beep sound)
Inrush Current	80mA maximum	Degree of Protection	LB3Z-1T0*: IP54 (IEC60529) LB3Z-104K: IP40 (IEC60529)
Sound Pressure (at 0.1m)	Steady sound: 80 dB minimum (at the rated voltage)	Terminal Style	LB3Z-1T0*: Solder/tab terminal #110 PC board terminal LB3Z-104K: Solder terminal
Sound Frequency	2.3±0.3kHz	Weight (approx.)	11g (LB3Z-1T0*), 8g (LB3Z-104K)
Response Speed	50 ms maximum		
Operating Temperature	-25 to +60°C (no freezing)		
Storage Temperature	-30 to +80°C (no freezing)		
Operating Humidity	45 to 85% (no condensation)		
Insulation Resistance	100 MΩ minimum (500V DC megger)		

• For applicable standards and UL, CSA ratings, see page 22.

Name and Shape	Operating Voltage	Terminal Style	Part No.	
			IP54	IP40
Rectangular  	24V DC	Solder/tab terminal	<b>LB3Z-1T04</b>	—
		PC board terminal	<b>LB3Z-1T04V</b>	—
		Solder terminal	—	<b>LB3Z-104K</b>

• 12V DC operating voltages also available. Specify “-1T04” in place of “-1T03” in the Part No.  
Example: **LB3Z-1T03**

### Dimensions

#### IP54

#### Terminal Arrangement (Bottom View)

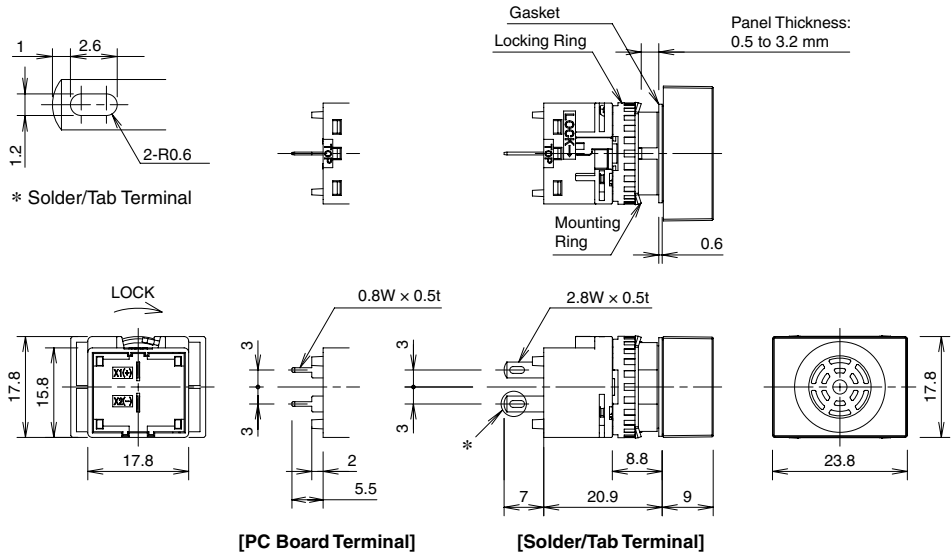
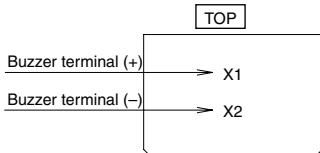

#### IP40

#### Terminal Arrangement (Bottom View)

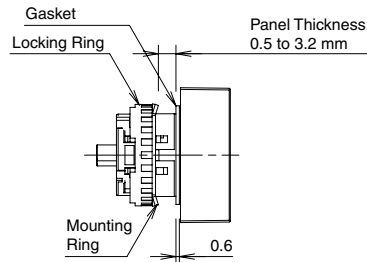
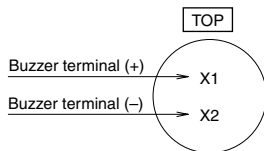

- For details on mounting hole layout, see page 49.
- For details on pc board and circuit design, see page 50.
- For details on single board mounting, see page 51.

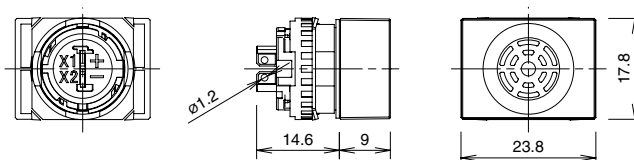

All dimensions in mm.

# LB/LBW Series Contact Operation

## Contact Operation

### Selector Switch / Illuminated Selector Switch / Key Selector Switch

Operator Position & Contact Operation (Top View)					
Position		Contact	↙ Left	↑ Center	↘ Right
90° 2-position		SPDT		/	
		DPDT		/	
		3PDT		/	
45° 3-position		DPDT			
		3PDT			

### Lever Switch

Lever Position & Contact Operation (Top View)					
Position		Contact	Down	Center	Up
90° 2-position		SPDT		/	
		DPDT		/	
		3PDT		/	
45° 3-position		DPDT			
		3PDT			



## Mounting Hole Layout / PC Board Drilling Layout

### LB Series Flush Bezel Round (LB6/LB6M)

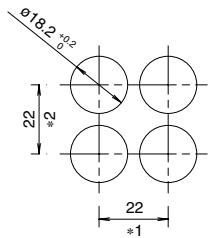

\*1: 23.2 mm for 3PDT contacts  
\*2: 45 mm for switches with guard

### Square (LB7/LB7M)

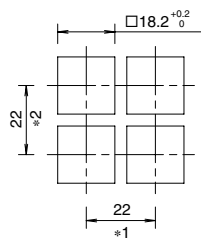

Note: When using the LB series with a rubber boot or terminal cover, make sure to note the dimensions on page 56.

### Rectangular (LB8/LB8M)

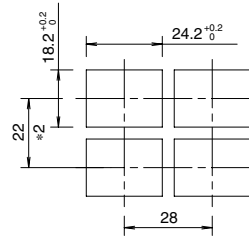

### LBW Series Flush Bezel Round (LBW6/LB6M/LBW6G)

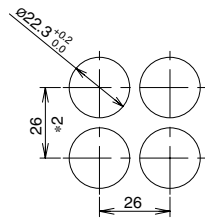

\* 53 mm for switches with guard

### Square (LBW7/LBW7M/LBW7G)

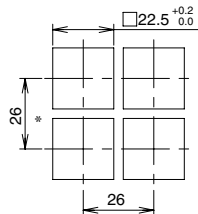

\* 53 mm for switches with guard

### LB Series Standard Bezel (LB1/LB2/LB3)

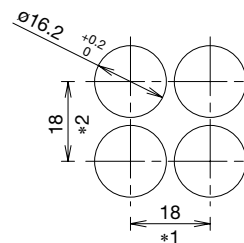

\*1: 24 mm for rectangular type  
23.2 mm for 3PDT contacts  
\*2: 21 mm for 3PDT contacts

## Panel Cut-out for Positioning

### LB Series Flush Bezel Round (LB6/LB6M)

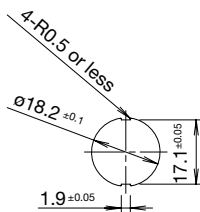

### LBW Series Flush Bezel Round (LBW6/LBW6M/LBW6G)

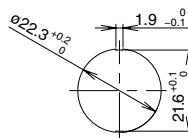

### LB Series Standard Bezel Round (LB1/LB2/LB3)

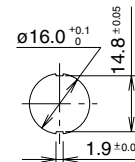

## Approval Ratings and CCC Approval File No.

### UL

#### Gold Contact

Rated Operating Voltage	30V DC	125V AC
Rated Operating Current	0.1A	0.1A

#### Silver Contact

Rated Operating Voltage		30V	125V	250V	
Rated Operating Current	AC	Res.	—	3.5 A, 2, 3, 5A	
		Ind.	—	2A, 1.5A	
	DC	Res.	2, 3, 5A	0.4A	—
		Ind.	1A	0.2A	—

### CSA

#### Gold Contact

Rated Operating Voltage	30V DC	125V DC
Rated Operating Current	0.1A	0.1A

#### Silver Contact

Rated Operating Voltage		30V	125V	250V	
Rated Operating Current	AC	Res.	—	3A, 2, 3, 5A	
		Ind.	—	2A, 1.5A	
	DC	Res.	2, 5A	0.4A	—
		Ind.	1A	0.2A	—

### TÜV

#### Gold Contact

Rated Operating Voltage	30V DC	125V AC
Rated Operating Current	0.1A (DC-12)	0.1A (AC-12)

#### Silver Contact

Rated Operating Voltage		30V	125V	250V
Rated Operating Current	AC-12	—	3A	2, 5A
	DC-12	2, 5A	0.4A	—

### CCC

#### Gold Contact

Rated Operating Voltage	30V DC	125V AC
Rated Operating Current	0.1A (DC-12)	0.1A (AC-12)

#### Silver Contact

Rated Operating Voltage		30V	250V
Rated Operating Current	AC-12	—	2, 5A
	DC-12	2, 5A	—

# LB/LBW Series Notes for Designing PC Board and Circuit

## Notes for Designing PC Board and Circuit

- Use 1.6-mm-thick glass epoxy PC board with drilled holes.
- Design a circuit so that the LB/LBW series can operate within the rated voltage and current range. Make sure that inrush current and voltage do not exceed the rating.
- Minimum applicable load is 5V AC/DC, 1 mA on gold contacts. Applicable range is subject to the operating condition and load.
- Since the \*2.8-mm-wide terminal touches the PC board as shown on the right, short circuit may occur with pattern lines. Design a circuit that prevents short circuits.

### SPDT/DPDT Contacts

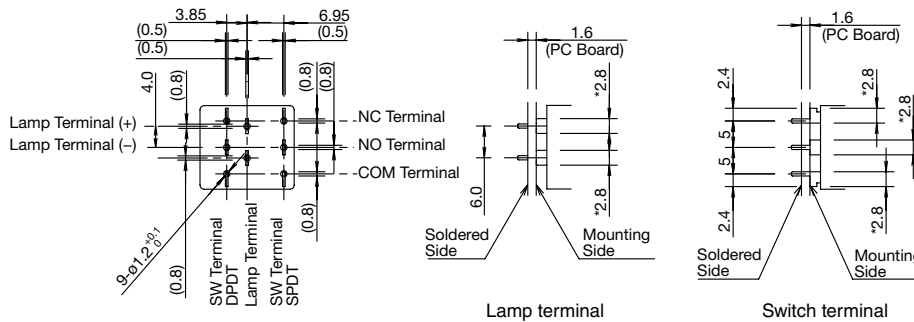

### 3PDT Contacts

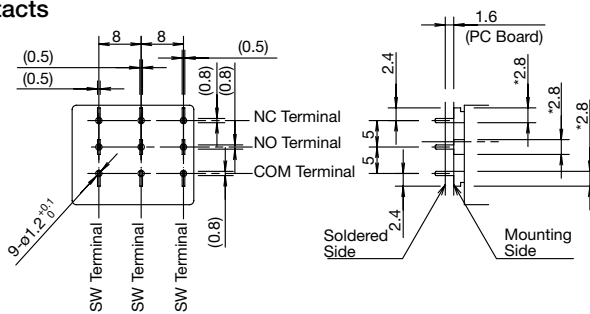

## PC Board Drilling Layout (Bottom View)

### SPDT/DPDT Contacts

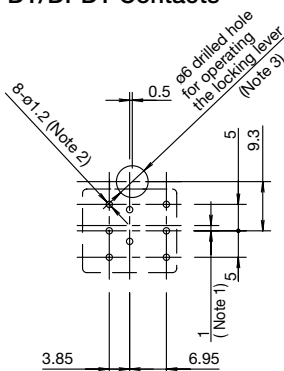

### 3PDT Contacts

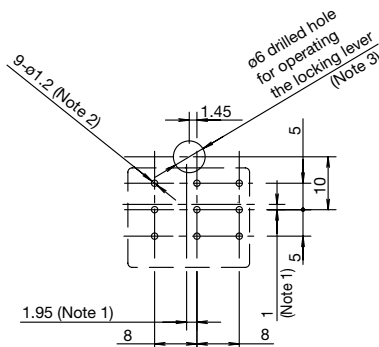

Note 1: When designing, note the alignment of center lines of the contact blocks and center lines of the operators.

Note 2: The diameter of the terminal hole is ø1.2.

Note 3: Hole diameter may vary to meet installation requirements. Determine the location and the size of the hole so that the locking lever can be operated.

All dimensions in mm.

Flush Silhouette LB Series
Flush Silhouette LBW Series
ø16 LB Series
UP Series

## Single Board Mounting

IDEC's LB/LBW Series is available for single board mounting.

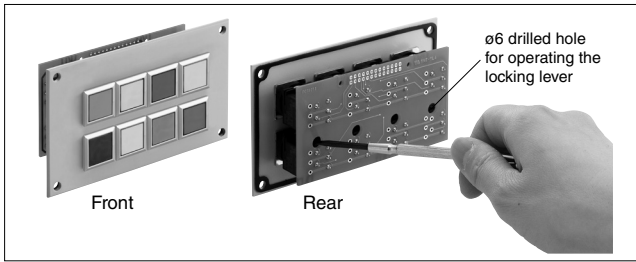

### Installing and Removing Contact Blocks

Turn the locking lever to install and remove contact blocks on the PC using a screwdriver from a hole in the PC board. See "Notes for Designing PC Board and Circuit" on page 50. Determine the location of the switches so that the locking lever can be operated. See "Removing and Installing the Contact Block" on page 61.

### Mounting Holes and Assembly Procedure

Drill mounting holes in the panel as shown below. When the units are mounted collectively, provide adequate clearance.

#### Panel Cut-out for Positioning

##### Standard Bezel (LB1/LB2/LB3/LB4)

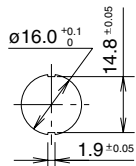

##### LB Series Flush Bezel (LB6/LB6M/LB6G)

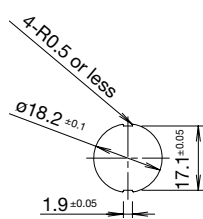

##### LBW Series Flush Bezel (LBW6/LBW6M/LBW6G)

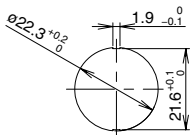

#### Mounting Hole Layout

##### Standard Bezel (LB1/LB2/LB3/LB4)

###### SPDT/DPDT Contacts

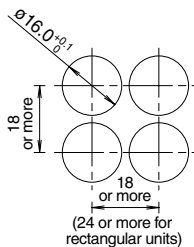

###### 3PDT Contacts

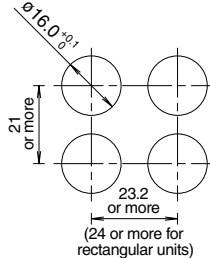

##### LB Series Flush Bezel

###### SPDT/DPDT Contacts LB6/LB6M/LB6G

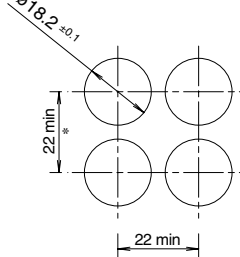

###### 3PDT Contacts

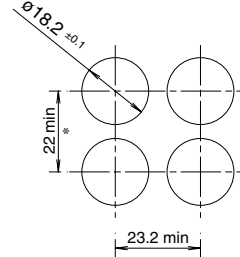

##### LB7/LB7M/LB7G

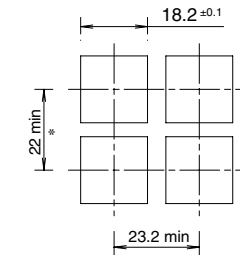
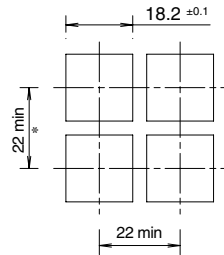

##### LB8/LB8M/LB8G

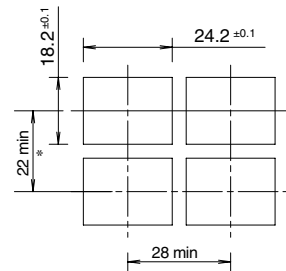
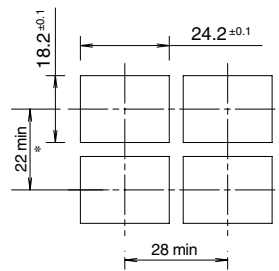

\* 45 mm minimum for switches with guard

##### LBW Series Flush Bezel LBW6/LBW6M/LBW6G

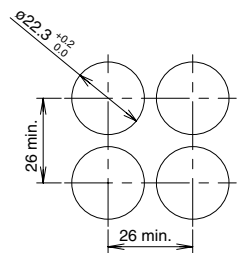

##### LBW Series Flush Bezel LBW7/LBW7M/LBW7G

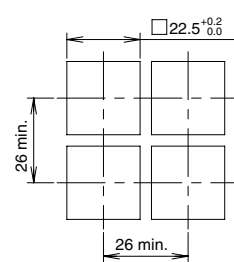

\* 53 mm minimum for switches with guard

#### Assembly Procedure

1. Install the operator to the panel.
2. Mount the contact block to the operator from the rear.
3. Turn the locking lever to lock the contact block.
4. Insert the PC board to terminals and solder.

- Note 1: Make sure that each terminal is inserted into the PC board correctly.
- Note 2: Do not apply tensile force to the connector cable for an extended period of time.
- Note 3: Do not expose the contact block to water.
- Note 4: Ensure to lock contact blocks when the contact blocks are installed on the operators.
- UP series can be installed on the same board. For details, see page 52.

Illuminated Pushbutton
Pilot Light
Pushbutton
Selector
Illuminated Selector
Key Selector
Lever Switch
Buzzer
Accessories
Maintenance Parts
Panel Cut-out
Instructions

# UP Series Single Board Mount Pilot Lights

## Mounts on the same panel as LB/LBW series





- Three illumination colors: Green (G), red (R), and white (W)

### Specifications

Color Code		Red (R), White (W)	G (Green)
Rated Current (I)		7mA	2mA
Maximum Current (Ta: 25°C)	Reverse Voltage (V <sub>R</sub> )	9V	5V
	Operating Temperature (T <sub>opr</sub> )	-25 to +55°C (no freezing)	
	Storage Temperature (T <sub>stg</sub> )	-30 to +80°C (no freezing)	
Forward Voltage (V <sub>f</sub> )		Standard value: 2V (I <sub>f</sub> =7mA)	Standard value: 2.7V (I <sub>f</sub> =2 mA)
Dielectric Voltage			
Between live and dead parts: 500V AC, 1 minute			
Weight (approx.)		4.3g (UP8-89V1), 5.1g (UP8-89V2)	



### UP Series

Mounting Hole Size	Shape	Degree of Protection (IEC 60529)	Mountable Unit	Part No.	Ordering No.	Illumination Color Code	Package Quantity
ø8 UP8  With standard bezel  With flush bezel	Shroud	IP40	Standard Bezel	UP8-89V1*	UP8-89V1*PN10	Specify the color code in place of * in the Part No.  G: green R: red W: white	10
			Flush Bezel	UP8-89V2*	UP8-89V2*PN10		
ø9 UP9P  With standard bezel 	Shroud	IP65	Standard bezel Flush bezel	UP9P-99V1*	UP9P-99V1*PN10		10

• LED cannot be replaced.

Note: Connect an external current limiting resistor in series. Otherwise, the LED may be damaged.

### Dimensions

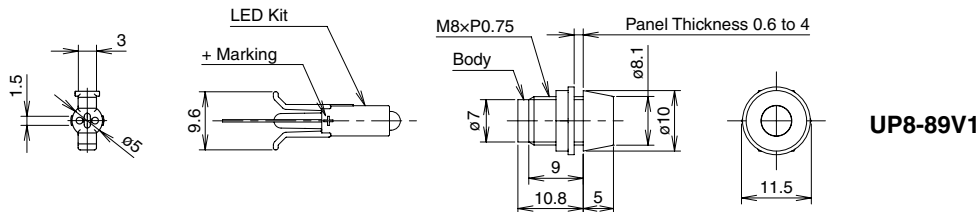

### [Assembly Drawing]

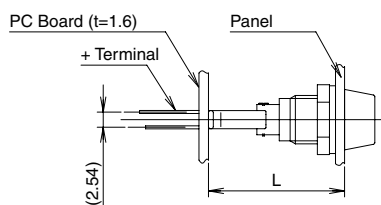

#### Dimensions (L)

Standard Bezel	22.5mm
Flush Bezel	29.9mm

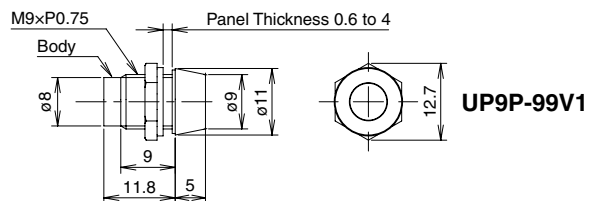
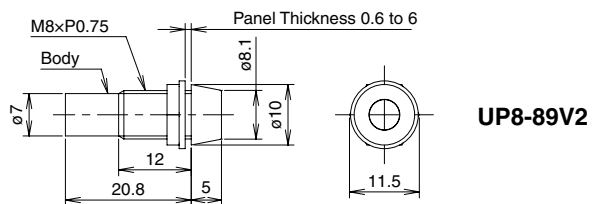

### PC Board Mounting Hole

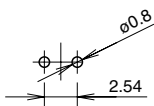

### Panel Cut-out

UP8

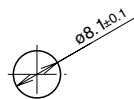

UP9P

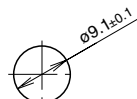

### Internal Circuit

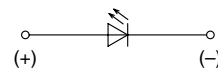

The longer pin is the positive terminal

All dimensions in mm.

# UP Series Single Board Mount Pilot Lights

## Safety Precautions

- Turn off power to the unit before installation, removal, wiring, maintenance, and inspection. Failure to turn off may cause electrical shocks or fire hazard.
- For wiring, use wires of a proper size to meet the voltage and current requirements.
- Improper soldering or failure to tighten the terminal screw may cause overheating and fire.

## Single Board Mounting

UP series miniature pilot light single board mounting types can be mounted with LB/ LBW series on the same panel. Follow the instructions below on single board mounting.

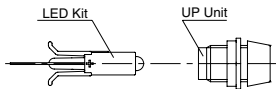

1. Mount the LED kit to the PC board.

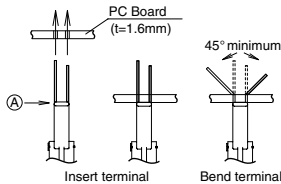

### Temporary mounting

1. Note the polarity of the terminals and insert the terminals to the PC board.
2. Make sure that part A of the LED kit is pressed tightly to the PC board. Bend the terminals sideways as shown on the left.

2. Mount the operator and the UP series pilot lights on to the control panel.

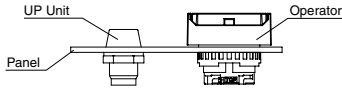

3. Mount the contact block to the operator of the miniature control unit and lock the unit by turning the locking lever.

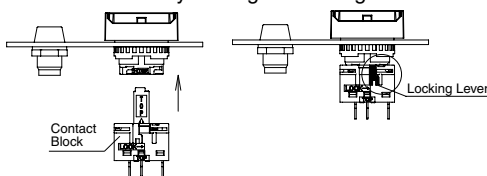

4. Install the PC board in 1. to the panel in 3.

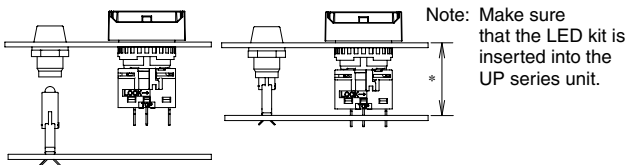

- \* When mounting LB/LBW and UP series on a single board, make sure that the distance between the front of the panel and the mounting side of the PC board (gasket distortion is taken into consideration) is as shown in the table below.

Part No.	Mountable Unit	Distance (*)
UP8-89V1*	Standard bezel	22.5mm
UP8-89V2*	Flush bezel	29.9mm
UP9P-99V1*	Standard bezel	22.5mm
	Flush bezel	29.9mm

5. Solder the terminals.  
Before soldering, make sure that each terminal of the contact block is securely inserted into the PC board holes.

## Instructions

### Polarity

Pay attention to the polarity of the power supply as UP series units do not contain a diode for protection against reverse polarity. The long terminal is positive and the short terminal is negative.

### Current Limiting Resistor

When using a UP series unit without a built-in current limiting resistor, connect an external current limiting resistor. Calculate the resistance using the following formula.

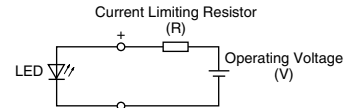

$$\text{Resistance } (\Omega) = \frac{\text{Operating Voltage (V)} - \text{Forward Voltage (Vf)}}{\text{Rated Current (I)} *}$$

- \* Rated Current (I) = R (red), W (white) : 0.007A  
G (green) : 0.002A  
Forward Voltage (Vf) = R (red), W (white): 2V  
G (green) : 2.7V

Note: Use a resistor of higher resistance than the calculated value ( $\Omega$ )

$$\text{Rated Wattage of Resistor (W)} = \text{Rated Current (I)} \times \text{Operating Voltage (V)} \times 2 \text{ to } 3 *$$

\* 2 to 3 is a safety factor

### <Current Limiting Resistor Reference Value>

Operating Voltage	Color	Red (R), White (W)	Green (G)
	5V DC		430 $\Omega$ (1/4W)
6V DC		560 $\Omega$ (1/4W)	1600 $\Omega$ (1/4W)
12V DC		1500 $\Omega$ (1/4W)	4700 $\Omega$ (1/4W)
24V DC		3000 $\Omega$ (1/2W)	11000 $\Omega$ (1/4W)

### Countermeasures against Dim Lighting

See page 66.

### Wiring

Solder the terminal at 350°C within 3 seconds using a 60W soldering iron. SnAgCu type lead-free solder is recommended. When soldering, do not touch the pilot light housing with the terminal. Do not bend the terminal or apply excessive force to the terminal.

### Notes on Panel Mounting

Tightening torque should not exceed 0.49 N·m. Do not use pliers. Do not tighten with excessive force, otherwise the locking ring will be damaged.

### PC Board and Circuit Design

Use glass epoxy copper clad laminate, double-sided through-hole PC boards with a thickness of 1.6 mm.

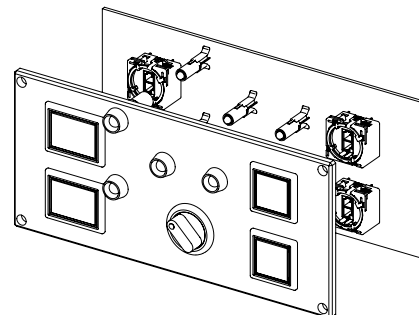

Example of single board mounting

Flush Silhouette  
LB Series

Flush Silhouette  
LBW Series

$\phi$ 16  
LB Series

UP Series

Illuminated  
Pushbutton

Pilot Light

Pushbutton

Selector

Illuminated  
Selector

Key Selector

Lever Switch

Buzzer

Accessories

Maintenance  
Parts



Panel  
Cut-out

Instructions

# LB/LBW Series Accessories



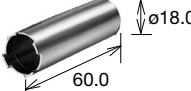
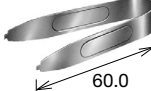
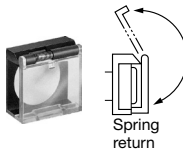
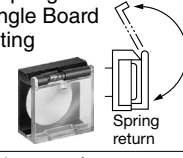
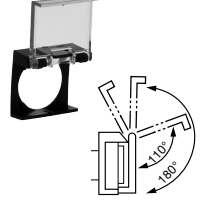
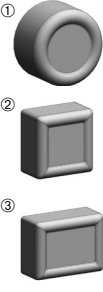











## Accessories

Package Quantity:1

Shape	Specification	Part No.	Ordering No.	Package Quantity	Remarks		
<b>Locking Ring Wrench</b> 	Metal (Nickel-plated brass)	<b>MT-001</b>	<b>MT-001</b>	1	Used to tighten the locking ring when installing the units on to the panel.		
<b>Lens Removal Tool</b> 	Stainless Steel	<b>MT-101</b>	<b>MT-101</b>	1	Used to remove the lens or button. (for standard bezels)		
<b>For Standard Bezels</b>	<b>180° Spring return</b> 	For round / square units (LB1/LB2)	Guard (Polyacetal)	<b>AL-K6SP</b>	<b>AL-K6SP</b>	Degree of protection: IP65 Used to protect pushbuttons and illuminated pushbuttons from inadvertent operation. See page 56 for dimensions. With the gasket mounted on the switch, attach the switch guard and mount on the panel.	
		For rectangular units (LB3/LB4)	Base (Polyarylate)	<b>AL-KH6SP</b>	<b>AL-KH6SP</b>		1
	<b>180° Spring return for Single Board Mounting</b> 	For rectangular units (LB3/LB4)	Guard (Polyacetal) Base (Polyarylate)	<b>LA9Z-K3</b>	<b>LA9Z-K3</b>	1	Degree of protection: IP65 With the gasket mounted on the switch, attach the switch guard and mount on the panel. See page 56 for dimensions.
	<b>Remains 110°/180° open (Can be used for single board mounting)</b> 	For round / square units (LB1/LB2)	Guard (Polyacetal) Base (Polyarylate)	<b>LB9Z-K2</b>	<b>LB9Z-K2</b>	1	Degree of protection: IP40 Used to protect pushbuttons and illuminated pushbuttons from inadvertent operation. See page 56 for dimensions. With the gasket mounted on the switch, attach the switch guard and mount on the panel. See page 56 for dimensions. When using for single board mounting, remove the rubber gasket from the switch.
		For rectangular units (LB3/LB4)		<b>LB9Z-K3P</b>	<b>LB9Z-K3P</b>	1	Degree of protection: IP65 With the gasket mounted on the switch, attach the switch guard and mount on the panel. See page 56 for dimensions.
	<b>Rubber Boot</b> 	1. For round units (LB1) 2. For square units (LB2) 3. For rectangular units (LB3/LB4)	Rubber (Transparent silicon rubber)	<b>LB9Z-D1</b>	<b>LB9Z-D1</b>	1	Degree of protection: IP65 See page 56 for dimensions. See page 65 for mounting.
			<b>LB9Z-D2</b>	<b>LB9Z-D2</b>	1		
			<b>LB9Z-D3</b>	<b>LB9Z-D3</b>	1		
<b>Mounting Hole Plug</b> 	Metal	[Plug] Metal (Zinc diecast) [Locking nut] Polyacetal [Gasket] Nitrile rubber	<b>AL-BM6</b>	<b>AL-BM6</b>	1	Degree of protection: IP65 Tightening torque: 0.1 to 0.29 N·m See page 56 for dimensions.	
<b>Mounting Hole Plug</b> 	Rubber	Nitrile rubber (black)	<b>AL-B6</b>	<b>AL-B6PN05</b>	5	Degree of protection: IP65 See page 56 for dimensions.	

## Accessories

Package Quantity: 1

Shape		Specification	Part No.	Ordering No.	Package Quantity	Remarks	
For LB Series Flush Bezels	<b>Rubber Boot</b>   	1. For round units (LB6/LB6M) 2. For square units (LB7/LB7M) 3. For rectangular units (LB8/LB8M)	Rubber (Transparent silicon rubber)	<b>LB9Z-D6</b>  <b>LB9Z-D7</b>  <b>LB9Z-D8</b>	<b>LB9Z-D6</b>  <b>LB9Z-D7</b>  <b>LB9Z-D8</b>	1  1  1  Degree of protection: IP65 See page 57 for dimensions. See page 65 for mounting.	
	<b>Mounting Hole Plug</b>   	1. For round units (LB6/LB6M) 2. For square units (LB7/LB7M) 3. For rectangular units (LB8/LB8M)	[Plug] Polyamide (Black) [Gasket] Nitrile rubber [Mounting Plate] Stainless Steel	<b>LB9Z-BS6*</b>  <b>LB9Z-BS7*</b>  <b>LB9Z-BS8*</b>	<b>LB9Z-BS6*</b>  <b>LB9Z-BS7*</b>  <b>LB9Z-BS8*</b>	1  1  1  * Color code: blank (black), W (white) Degree of protection: IP65 Panel thickness: 0.5 to 3.2 mm See page 57 for dimensions.	
		<b>Mounting Hole Plug</b>  	1. For round units (LBW6/LB6W6M) 2. For rectangular units (LBW7/LB6W7M)	[Plug] Polyamide (Black) [Gasket] Nitrile rubber [Mounting Plate] Stainless Steel	<b>LBW9Z-BS6*</b>  <b>LBW9Z-BS7*</b>	<b>LBW9Z-BS6*</b>  <b>LBW9Z-BS7*</b>	1  1  * Color code: blank (black), W (white) Degree of protection: IP65 Panel thickness: 0.5 to 3.2 mm See page 58 for dimensions.
			<b>Mounting Hole Plug</b> 	Metal	[Plug] Zinc diecast [Locking Ring] Polyamide [Gasket] Nitrile rubber	<b>LW9Z-BM</b>	<b>LW9Z-BM</b>
	<b>Mounting Hole Plug</b> 	Rubber	Nitrile rubber	<b>LW9Z-BP1</b>	<b>LW9Z-BP1</b>	1  Degree of protection: IP65 Tightening torque: 2.0 N·m See page 58 for dimensions.	
	<b>Terminal Cover</b>  	1. For SPDT/DPDT contacts 2. For 3PDT contacts	PBT (White)	<b>LB9Z-VL2</b>  <b>LB9Z-VL3</b>	<b>LB9Z-VL2PN10</b>  <b>LB9Z-VL3PN10</b>	10  10  See page 58 for dimensions. See page 61 for mounting.	
<b>Key</b>  Reversible key  Non-reversible key		For key selector switches (wave key)	Metal (zinc nickel-plated)	<b>LA9Z-SK-*</b>	<b>LA9Z-SK-*PN02</b>	2  Specify a key number in place of * in the Part No. Blank: Standard key 0H (reversible) 1H to 2H: Reversible key 3H to 6H: Non-reversible key See page 58 for dimensions.	
<b>Keys</b> 	For key selector switches (disc tumbler key)	Metal (brass nickel-plated) 18x1.8x25.1 t1.8	<b>AS6-SK-132</b>	<b>AS6-SK-132PN02</b>	2  		

Flush Silhouette LB Series

Flush Silhouette LBW Series

ø16 LB Series

UP Series

Illuminated Pushbutton

Pilot Light

Pushbutton

Selector

Illuminated Selector

Key Selector

Lever Switch

Buzzer

Accessories

Maintenance Parts

Panel Cut-out

Instructions

# LB/LBW Series Accessories

## Dimensions for Accessories

All dimensions in mm.

### For LB Series Standard Bezel

#### Rubber Boot

For round units  
(LB9Z-D1)

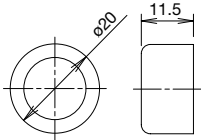

For square units  
(LB9Z-D2)

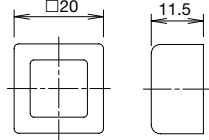

For rectangular units  
(LB9Z-D3)

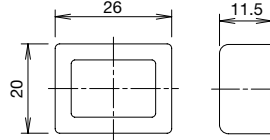

#### Mounting Hole Plug

AL-B6

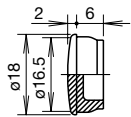

Mounting Hole  
Layout

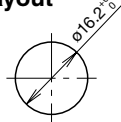

AL-BM6

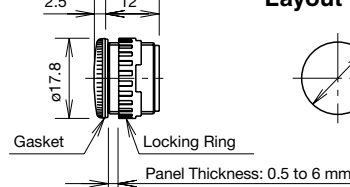

Mounting Hole  
Layout

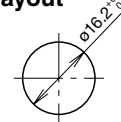

#### Switch Guard (Spring Return)

For round / square units  
(AL-K6SP)

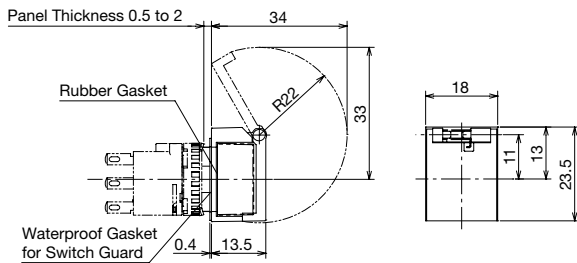

For rectangular units  
(AL-KH6SP)

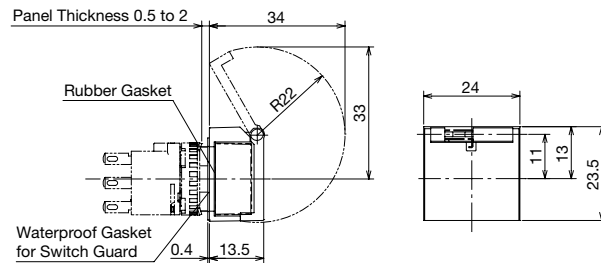

#### For Single Board Mounting (LA9Z-K3) (Note)

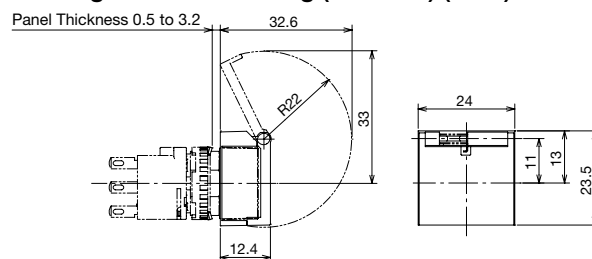

Note: The panel depth is the same for switches with or without switch guards. Both types can be installed on the same PC board.

#### Switch Guard (Remains Open)

For round / square units (Note)  
(LB9Z-K2)

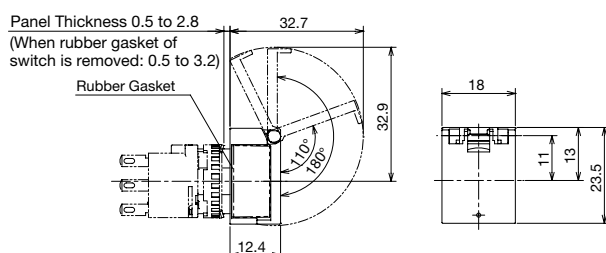

For rectangular units (Note)  
(LB9Z-K3P)

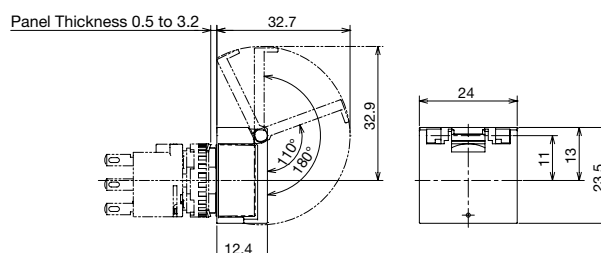



## Dimensions for Accessories

### For LB Series Flush Bezel

#### Rubber Boot

For round units  
(LB9Z-D6)

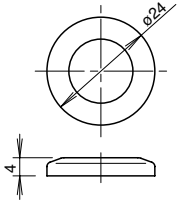

For square units  
(LB9Z-D7)

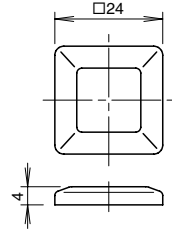

For rectangular units  
(LB9Z-D8)

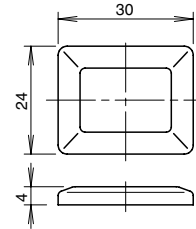

#### Mounting Hole Plug

For round units  
(LB9Z-BS6\*)

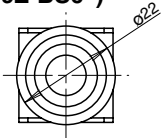

For square units  
(LB9Z-BS7\*)

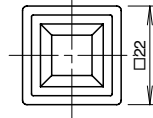

For rectangular units  
(LB9Z-BS8\*)

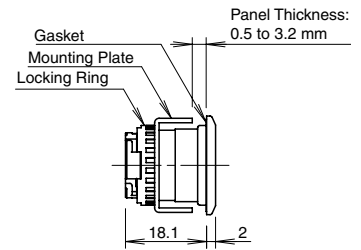
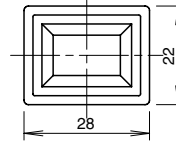

#### Mounting Hole Layout

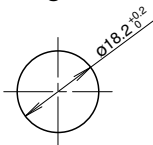

#### Mounting Hole Layout

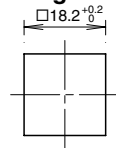

#### Mounting Hole Layout

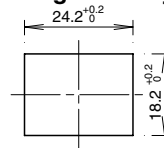

Flush Silhouette LB Series
Flush Silhouette LBW Series
ø16 LB Series
UP Series

Illuminated Pushbutton
Pilot Light
Pushbutton
Selector
Illuminated Selector
Key Selector
Lever Switch
Buzzer
Accessories
Maintenance Parts
Panel Cut-out
Instructions

# LB/LBW Series Accessories

## Dimensions for Accessories

### For LB Series Flush Bezel

#### Mounting Hole Plug

**Metal  
(LW9Z-BM)**

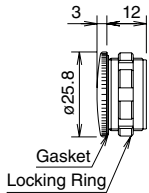

**Mounting  
Hole Layout**

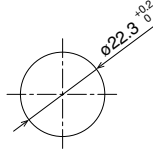

**Rubber  
(LW9Z-BP1)**

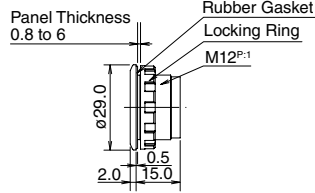

**Mounting  
Hole Layout**

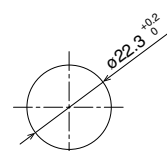

**For round units  
(LBW9Z-BS6\*)**

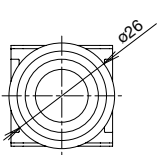

**Mounting  
Hole Layout**

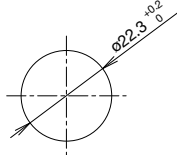

**For square units  
(LBW9Z-BS7\*)**

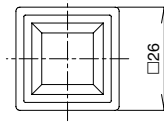

**Mounting  
Hole Layout**

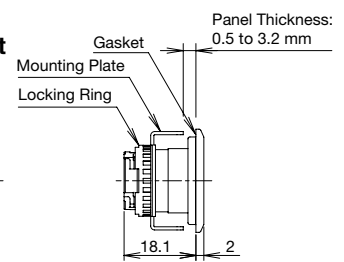
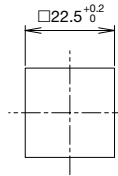

#### Terminal Cover

**For SPDT/DPDT contacts  
(LB9Z-VL2)**

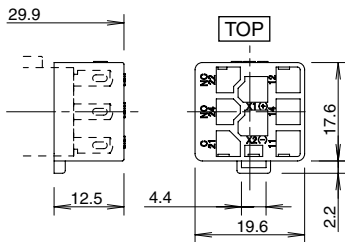

**For 3PDT contacts  
(LB9Z-VL3)**

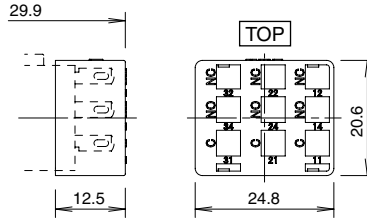

#### Key (Wave Key)

**Reversible key**

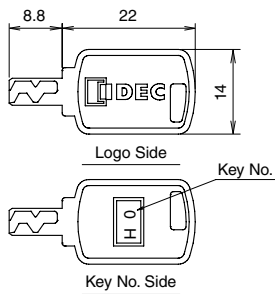

**Non-reversible key**

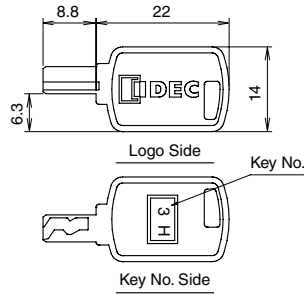

All dimensions in mm.

## Accessories

Flush Silhouette  
LB Series

Flush Silhouette  
LBW Series

ø16  
LB Series

UP Series

Illuminated  
Pushbutton

Pilot Light

Pushbutton

Selector

Illuminated  
Selector

Key Selector

Lever Switch







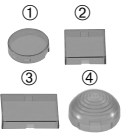
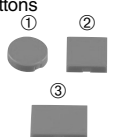
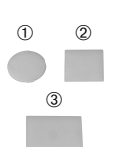

Buzzer

Accessories

Maintenance  
Parts

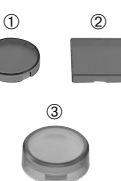
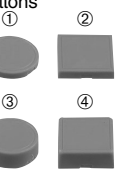
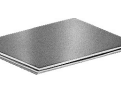
Panel  
Cut-out

Instructions

Shape		Material / Dimensions (W×H×D)	Part No.	Ordering No.	Package Quantity	Remarks
<b>Lens</b> 	1. For round units	Polyarylate ø15.4 H4	<b>AL6M-L*</b>	<b>AL6M-L*PN05</b>	5	Specify the color code in place of * in the part no. A: Amber, C: Clear, G: Green, R: Red, S: Blue, Y: Yellow  Note: Use a clear lens for white (W) or pure white (PW) illumination.
	2. For square units	Polyarylate □15.4 H4	<b>AL6Q-L*</b>	<b>AL6Q-L*PN05</b>	5	
	3. For rectangular units	Polyarylate W21.4 H4 D15.4	<b>AL6H-L*</b>	<b>AL6H-L*PN05</b>	5	
	4. For dome units	Polyarylate ø16 H9.4	<b>AL6D-L*</b>	<b>AL6D-L*PN05</b>	5	
<b>Buttons</b> 	1. For round units	Polyarylate ø15.4 H4	<b>AB6M-B*</b>	<b>AB6M-B*PN05</b>	5	Specify the color code in place of * in the part no. B: Black, G: Green, R: Red, S: Blue W: White, Y: Yellow
	2. For square units	Polyarylate □15.4 H4	<b>AB6Q-B*</b>	<b>AB6Q-B*PN05</b>	5	
	3. For rectangular units	Polyarylate W21.4 H4 D15.4	<b>AB6H-B*</b>	<b>AB6H-B*PN05</b>	5	
<b>Marking plate</b> 	1. For round units	Acrylic ø13.7 H0.8	<b>AL6M-*</b>	<b>AL6M-*PN05</b>	5	Specify the color code in place of * in the part no. B: Black, W: White  See page 63 for dimensions and engraving area.
	2. For square units	Acrylic □13.7 H0.8	<b>AL6Q-*</b>	<b>AL6Q-*PN05</b>	5	
	3. For rectangular units	Acrylic W19.7 H0.8 (0.4) D13.7	<b>AL6H-*</b>	<b>AL6H-*PN05</b>	5	
<b>Diffusion plate</b> 	For dome units	Acrylic ø13.6 H2.8	<b>AL6D-W</b>	<b>AL6D-WPN05</b>	5	White
<b>Anti-rotation Ring</b> 	Standard bezel	Metal (Stainless steel) □17.9 t0.6	<b>LB9Z-LP1</b>	<b>LB9Z-LP1PN10</b>	10	
<b>Anti-rotation Ring</b> 	Flush bezel	Metal (Stainless steel) 21×8.2×20.6 t0.8	<b>LB9Z-LP6</b>	<b>LB9Z-LP6PN10</b>	10	
<b>Lens</b> 	1. For round flush units	Polyarylate ø20 H4	<b>HA9Z-L11*</b>	<b>HA9Z-L11*PN05</b>	5	Specify the color code in place of * in the part no. A: Amber, C: Clear, G: Green, R: Red, S: Blue, Y: Yellow Note: Use a clear lens for white (W) or pure white (PW) illumination.
	2. For square flush units	Polyarylate ø20 H4	<b>HA9Z-L21*</b>	<b>HA9Z-L21*PN05</b>	5	
	3. For round extended units	Polyarylate ø20.2 H7.8	<b>LBW9Z-L12*</b>	<b>LBW9Z-L12*PN05</b>	5	
<b>Buttons</b> 	1. For round flush units	Polyacetal ø20 H3.2 (L5)	<b>HA9Z-B11*</b>	<b>HA9Z-B11*PN05</b>	5	Specify the color code in place of * in the part no. B: Black, G: Green, R: Red, S: Blue W: White, Y: Yellow
	2. For square flush units	Polyacetal ø20 H3.9 (L5)	<b>HA9Z-B21*</b>	<b>HA9Z-B21*PN05</b>	5	
	3. For round extended units	Polyacetal ø19.8 H7.3 (L9.1)	<b>HA9Z-B12*</b>	<b>HA9Z-B12*PN05</b>	5	
	4. For square extended units	Polyacetal ø19.8 H8 (L9.1)	<b>HA9Z-B22*</b>	<b>HA9Z-B22*PN05</b>	5	
<b>Marking plate</b> 	1. For round flush units	Acrylic ø17 t0.85 (L1.1)	<b>HA9Z-P1*</b>	<b>HA9Z-P1*PN05</b>	5	Specify the color code in place of * in the part no. B: Black, W: White See page 64 for dimensions and engraving area.
	2. For square units	Acrylic □18.4 t0.85	<b>HA9Z-P2*</b>	<b>HA9Z-P2*PN05</b>	5	
<b>Anti-rotation Ring</b> 	LBW series	Metal (Stainless steel) 25×8.2×24.8 t0.8	<b>LBW9Z-LP6</b>	<b>LBW9Z-LP6PN10</b>	10	
<b>Locking ring</b> 	All models	Polyamide ø17.9 H3.9	<b>LB9Z-LN</b>	<b>LB9Z-LNPN10</b>	10	
<b>Illuminated selector knob operator</b> 	Illuminated selector switches	<For operator> Polyarylate Waterproof O-gasket Nitril rubber ø15.4 H13	<b>LA1A-F*</b>	<b>LA1A-F*PN02</b>		Specify the color code in place of * in the part no. G: green, R: red, W: white

# LB/LBW Series Maintenance Parts

## Maintenance Parts

### LB Series Maintenance LED Unit

Package Quantity: 1

Shape	Rated Operating Voltage	Part No. (Ordering No.)	* Color Code
	5V DC	<b>LB9Z-LED5*</b>	A: Amber G: Green PW: Pure White R: Red S: Blue W: White
	12V AC/DC	<b>LB9Z-LED1*</b>	
	24V AC/DC	<b>LB9Z-LED2*</b>	

- All LB/LBW series contain an LED unit.
- Use a pure white (PW) LED unit for yellow (Y) illumination.

## Transformer

Package Quantity: 1

Transformer	Primary Voltage	Secondary Voltage	Part No. (Ordering No.)	Applicable Load
	AC100/110V	100/110V AC ±10%	<b>TWR512</b>	LB9Z-LED2* (24V AC/DC LED unit)
	AC200/220V	200/220V AC ±10%	<b>TWR522</b>	
	AC400/440V	400/440V AC±10%	<b>TWR542</b>	

- Terminal cover (TWR-VL3) is supplied as standard.
- Connect one LB9Z-LED2\* to a transformer.

### Specifications

Part No.	TWR5□2
Operating Voltage	100/110V AC, 200/220V AC, 400/440V AC (50/60Hz)
Current Draw	2.4VA
Rated Insulation Voltage	600V
Insulation Resistance	100 MΩ minimum (500V DC megger)
Operating Temperature	-30 to +60°C (no freezing)
Storage Temperature	-40 to +80°C (no freezing)
Operating Humidity	35 to 85% RH (no condensation)
Vibration Resistance	Damage Limits: 30 Hz, amplitude 1.5 mm Operating extremes: 5 to 55 Hz, amplitude 0.5 mm
Shock Resistance	Damage limits: 1,000 m/s <sup>2</sup> Operating Extremes: 100 m/s <sup>2</sup>
Dielectric Strength	2,500V AC, 1 minute
Terminal Screw	M3.5
Applicable Wire	2 mm <sup>2</sup> maximum, 2 wires maximum
Weight (approx.)	87g

### Dimensions

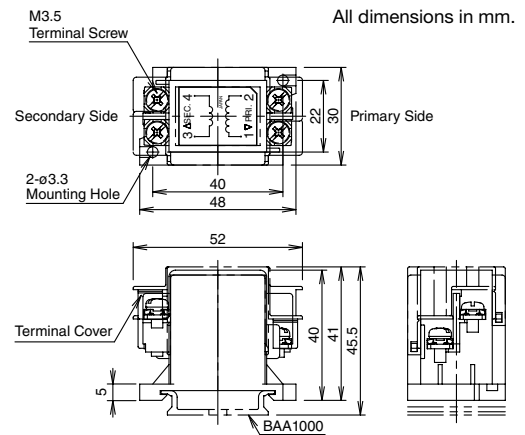

### Accessories

#### 35mm DIN Rail

Part No.	Ordering No.	Length	Material	Package Quantity
<b>BAA1000</b>	<b>BAA1000PN10</b>	1,000mm	Aluminum (approx. 200g)	10
<b>BAP1000</b>	<b>BAP1000PN10</b>	1,000mm	Steel (approx. 320g)	10

#### End Clip

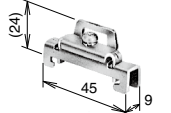
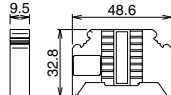
Part No.	Ordering No.	Applicable DIN Rail	Package Quantity	Dimensions
<b>BNL6</b>	<b>BNL6PN10</b>	BAA1000 BAP1000	10	 <p>Approx. 15g Steel (Zinc-plated)</p>
<b>BC9Z-E/NS35N</b>	<b>BC9Z-E/NS35NPN10</b>	BAA1000 BAP1000	10	 <p>Approx. 15g</p>

### Flush Silhouette Switch LB Series Flush Silhouette Switch LBW Series ø16mm LB Series Miniature Switches and Pilot Lights

#### Contents

⚠ <b>Safety Precautions</b> . . . . .	61		
<b>Instructions</b> . . . . .	61		
Wiring . . . . .	61	Terminal Cover . . . . .	61
Operating Environment . . . . .	61	Handling . . . . .	61
Removing and Installing the Contact Block . . . . .	62	Panel Mounting . . . . .	62
Replacing the Lens and Marking Plate . . . . .	62	Installing the Lens Unit and Contact Block . . . . .	63
Marking Plates and Films . . . . .	63	Replacing the LED Unit . . . . .	64
Notes on Using Quick Connect Terminals . . . . .	64	Installing the Rubber Boot . . . . .	65
Maintained Pushbuttons . . . . .	65	Switches with Guard . . . . .	65
Selector Switches . . . . .	65	Key Selector Switches . . . . .	66
<b>Single Board Mounting</b> . . . . .	51		
Installing and Removing Contact Blocks . . . . .	51	Mounting Holes and Assembly Procedure . . . . .	51

### ⚠ Safety Precautions

- Turn off the power to the LB/LBW series before installation, removal, wiring, maintenance, and inspection. Failure to turn power off may cause electrical shocks or fire hazard.
- To avoid burning your hand, use the lamp holder tool when replacing the lamps.
- For wiring, use wires of a proper size to meet voltage and current requirements. Solder correctly according to the instructions in "Wiring" and "Notes on Terminal Cover." Improper soldering may cause overheating and create a fire hazard. Also, when using tab terminals, use receptacles of appropriate size.

### Instructions

#### Wiring

- 1) Solder the terminals at 350°C within 3 seconds using a 60W soldering iron. Sn-Ag-Cu type is recommended when using leadfree solder. When soldering, do not touch the LB series with the soldering iron. Also ensure that no tensile force is applied to the terminal. Do not bend the terminal or apply excessive force to the terminal.
- 2) Use non-corrosive liquid flux.

#### Terminal Cover

##### Solder/tab terminal

Insert the terminal cover into the contact block with the TOP markings on the contact block and the terminal cover in the same direction.

Note: When wiring, insert the lead wires into the terminal cover holes before soldering.  
After wiring, the terminal covers cannot be installed.

##### Standard Bezel

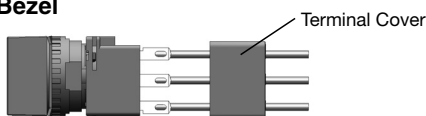

##### Flush Bezel

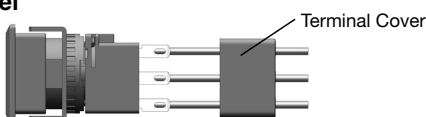

#### Operating Environment

- Do not use the LB/LBW series where corrosive gases exist or under an environment exceeding the operating temperature and humidity ranges. Otherwise, damages due to contact failure or change of surface color may occur.
- Major parts of the switch are plastic. Scratches or damages may occur when scraped with a sharp object or applied with excessive load or shock. Note that this may cause operation and appearance failure of the operator and bezel.
- Adherence of detergent, cutting oil, or special chemicals to the switch may result in operation failures and appearance failures such as change of surface color.

#### Handling

##### Contacts (micro switch)

When using NC (normally closed) and NO (normally open) contacts of the same microswitch, avoid connections of different voltages, or connections of different types of power supplies. Failure to observe this instruction may cause a short-circuit.

##### Protection against oil (IP65)

The LB series has been tested according to JIS C 0920: Appendix 1 by using water insoluble cutting oil Class N3, No. 8 (JIS K 2241) to prove that the switches will not be damaged by oil drops or splashes. This may not apply to special types of oils. Contact IDEC for details.

Flush Silhouette LB Series
Flush Silhouette LBW Series
ø16 LB Series
UP Series

Illuminated Pushbutton
Pilot Light
Pushbutton
Selector
Illuminated Selector
Key Selector
Lever Switch
Buzzer
Accessories
Maintenance Parts
Panel Cut-out
Instructions

## Instructions

### Removing and Installing the Contact Block

- 1) Turn the locking lever on the contact block in the direction opposite to the arrow on the housing. Then the contact block can be removed.
- 2) Insert the contact block with the TOP markings on the contact block and the operator placed in the same direction. Then lock the units, turning the locking lever in the direction of the arrow.

Note: When removing/installing the contact block, or when using the contact block alone, do not apply excessive force on the actuator. Deformed actuator may affect contact operation.

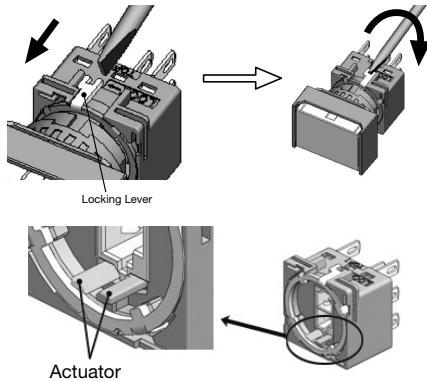

### Panel Mounting

Remove the contact block from the operator. Insert the operator into the panel cut-out from the front, then install the contact block to the operator.

(For Standard Bezel)

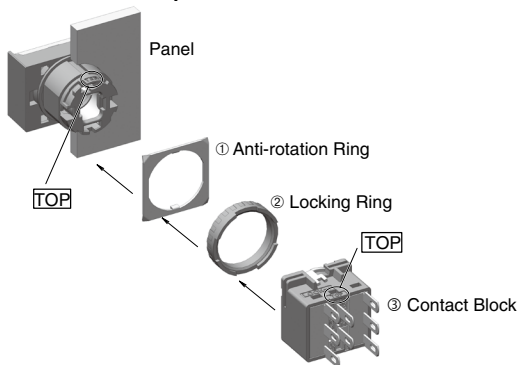

(For Flush Bezel)

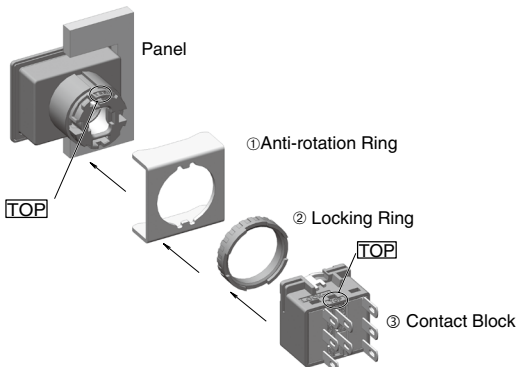

### Notes on Mounting

Use the optional ring wrench (MT-001) to mount the operator onto the panel. The recommended tightening torque is 0.5 to 0.7 N·m. Do not use pliers. Excessive tightening will damage the locking ring.

### Replacing the Lens and Marking Plate

#### Removing

[Removing the operator]

Standard Bezel

- 1) From the opposite side of the TOP marking, remove the operator (lens, marking plate, and lens holder) using the optional lens removal tool (MT-101) by gripping the recesses of the color lens.

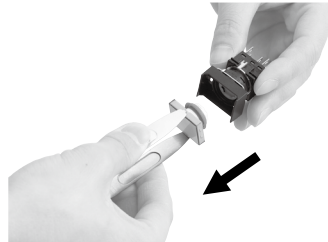

Flush Bezel

- 1) From the opposite side of the TOP marking, push the tip (width: 3 mm, thickness: 0.5 mm) of the flat screwdriver to the groove of the color lens and pull out the operator (lens, marking plate, lens holder).

Note: For metallic bezels, the bezel may be damaged if the screwdriver is inserted from the TOP side or inserted deeply or with force into the groove of the lens.

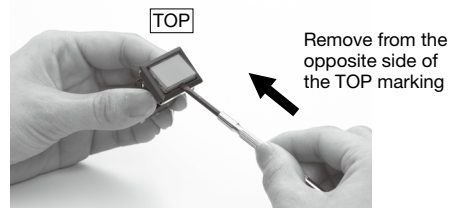

[Removing the Operator]

- 2) Remove the marking plate by pushing the lens from the rear to disengage the latches between the lens and holder, using the screwdriver as shown below.



Note: The translucent in the lens holder cannot be removed because this filter is sealed to make the unit waterproof and oiltight.

### LBW Series Pushbutton (button style)

LBW series pushbuttons (button style, see page 28) can be removed according to the following procedure. LBW series pushbuttons (button style) cannot be removed from the front of the panel.

[Removing the Operator]

- 1) Detach the operator unit and contact block. (See Removing and Installing the Contact Block at the top of the page.)
- 2) Remove the button unit (button, button holder) by pushing out the cross-shaped protrusion (white) at the back of the operator with a screwdriver.

## Instructions

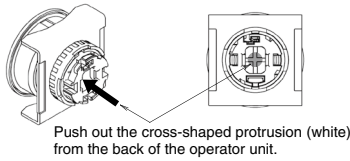

### Removing the Button

The button can be removed by inserting a small screwdriver into the groove of the button holder.

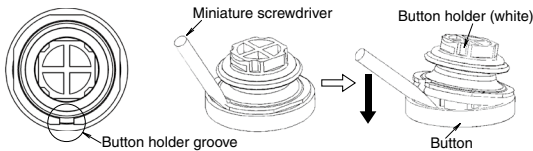

To attach the button to the button holder, align the groove on cross-shaped protrusion with the positioning protrusion on the button and insert securely.

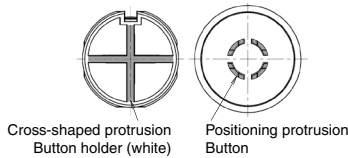

### Installing

Insert the marking plate into the color lens, and press the lens onto the lens holder to engage the latches. Pay attention to the orientation of the marking plate.

#### LB/LBW Series Round

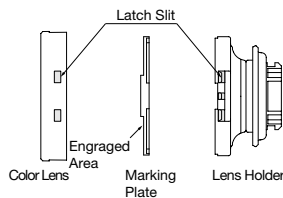

#### LB Series Square/Rectangular

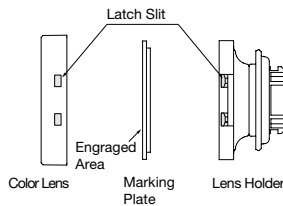

#### LBW Series Square

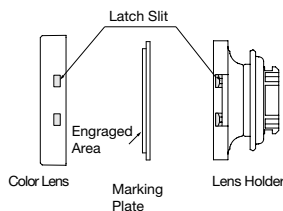

### Installing the Lens Unit and Contact Block

To insert the lens unit into the operator, press in the lens unit by making sure that the latch on the operator is aligned with the latch on the lens unit.

#### Round Lens Unit    Square Lens Unit

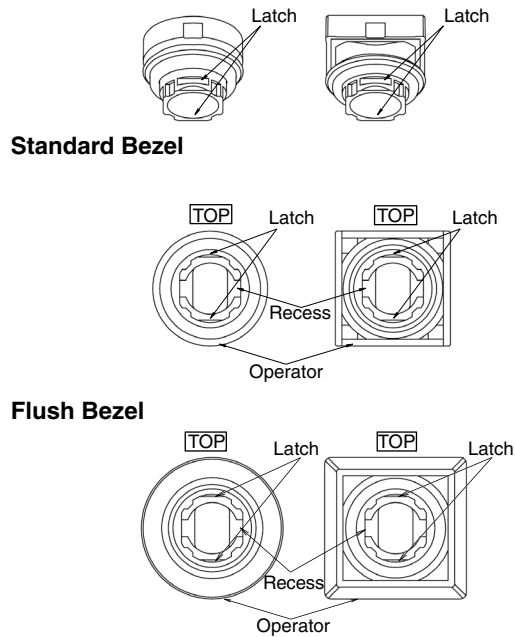

### Marking Plates and Films

For illuminated pushbuttons, pushbuttons with lens, and pilot lights, legends and symbols can be engraved on the marking plates, or printed film can be inserted under the lens for labelling purposes.

#### Marking Plate and Marking Film Size

##### LB Series (flush bezel / standard bezel)

Lens	Round	Square	Rectangular
Built-in Marking Plate			
Applicable Marking Film			
	<ul style="list-style-type: none"> <li>Engraving must be made on the engraving area within 0.5 mm deep.</li> <li>The marking plate is made of white acrylic resin.</li> <li>Film thickness: 0.1 mm per film</li> <li>Marking film is not included.</li> <li>Recommended marking film: Polyester film</li> </ul>		

- Illuminated Pushbutton
- Pilot Light
- Pushbutton
- Selector
- Illuminated Selector
- Key Selector
- Lever Switch
- Buzzer
- Accessories
- Maintenance Parts
- Panel Cut-out
- Instructions

# LB/LBW Series Instructions

## Instructions

### LBW Series

Lens	Round Flush	Square	Round Extended
Built-in Marking Plate			
Applicable Marking Film			
	<ul style="list-style-type: none"> <li>Engraving thickness: 0.5 mm max.</li> <li>The marking plate is made of white acrylic resin.</li> </ul>		
	<ul style="list-style-type: none"> <li>Film thickness: 0.1 mm per 2 films or 0.2 mm per film.</li> <li>Marking film is not included.</li> <li>Recommended marking film: Polyester film</li> </ul>		

### LBW Series (ring-illuminated model)

Lens	Round (Note)	Square
Applicable Marking Film		
	<ul style="list-style-type: none"> <li>Film thickness: 0.1 mm max.</li> </ul>	

Note: Use a film with adhesive and attach on the light shield sheet. Make sure that the marking film is properly installed and does not protrude from the edge of light shield sheet.

### Ring Illuminated Model Lens Holder

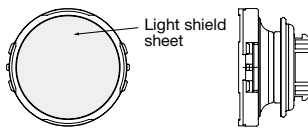

### Insertion Order of Marking Plate and Film

#### LB/LBW Series Round

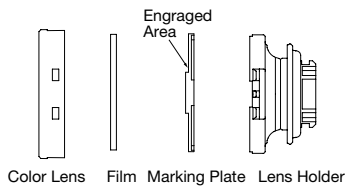

#### LB/LBW Series Square/Rectangular

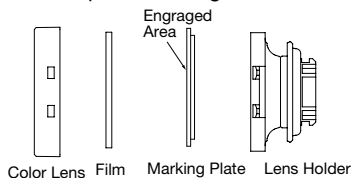

Note: Film is not included.

The marking plate must be engraved on the specified side as shown above. Pay attention to the orientation of the marking plate. When inserting a film, make sure to insert between the color lens and marking plate.

Note: Marking plate is not supplied with ring-illuminated model.

### Replacing the LED Unit

The LED unit can be replaced without tools by pulling out the lens unit from the contact block.

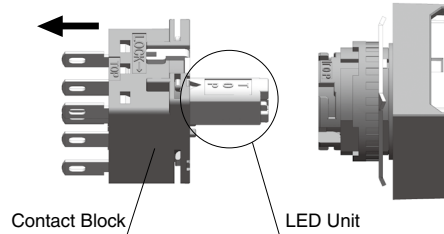

#### Orientation of the LED unit

Insert the LED unit into the contact block with the TOP markings on the contact block and LED unit in the same orientation.

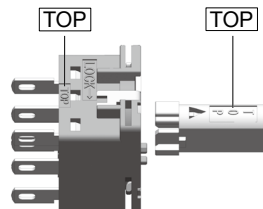

#### Notes on replacing the LED Unit

When replacing the LED unit, make sure that static electricity is not applied.

Make sure that the LB/LBW series has cooled down before replacing the LED unit. To avoid burn injuries, be careful not to touch the unit while it is still hot.

### Notes on Using Quick Connect Terminals

- Use #110 tab quick connects, 0.5 mm-thick.
- When connecting the terminals on the left and center, make sure that surfaces of the quick connects face each other. Otherwise, short-circuit may occur.

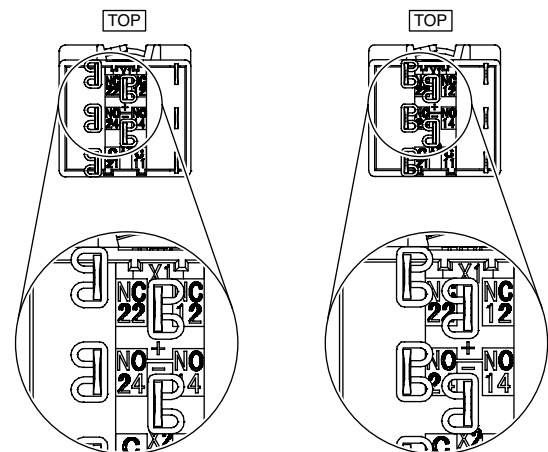

**Correct**

**Incorrect**

- Apply only horizontal force against the panel to the tab. The switch may be damaged if a force other than a horizontal force is applied.



Flush Silhouette LB Series
Flush Silhouette LBW Series
ø16 LB Series
UP Series

## Instructions

### Installing the Rubber Boot

When using in places where the switches are subjected to water splash or an excessive amount of dust, make sure to use the optional rubber boot.

As shown in the drawing below, ① remove the gasket from the operator, and ② attach the rubber boot from the front (button side).

#### Standard Bezel

For rectangular and square units, pull out the seals of the rubber boot and place them around the operator sleeve as shown below. Make sure that the seals are not twisted or tucked inside and that the gasket is removed, otherwise waterproof and dustproof characteristics are not ensured.

#### How to Install the Rubber Boot Rectangular

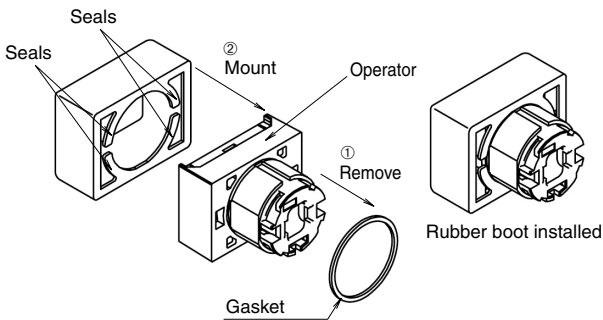

#### Square

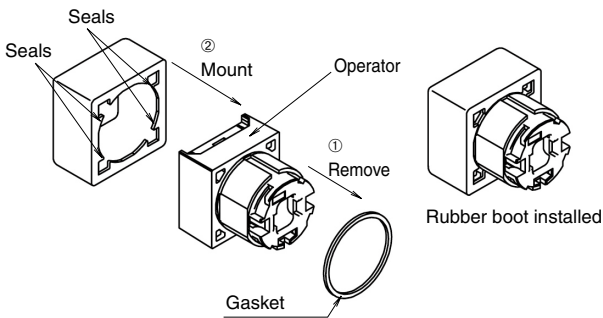

#### Round

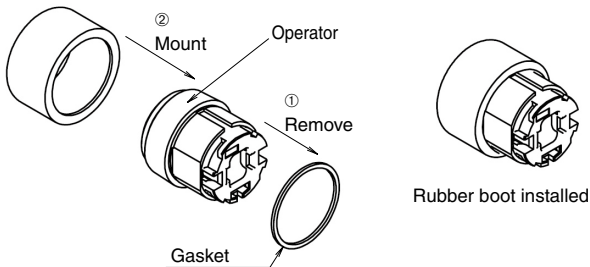

### Flush Bezel

Mount the rubber boot so that the protrusion at the bottom surface of the operator fits with the recess on the operator, placing the rubber boot all around the operator sleeve.

Make sure that the protrusion on the rubber boot and the recess on the operator is properly fitted, otherwise, the waterproof and dustproof characteristics are not ensured.

#### How to Install the Rubber Boot

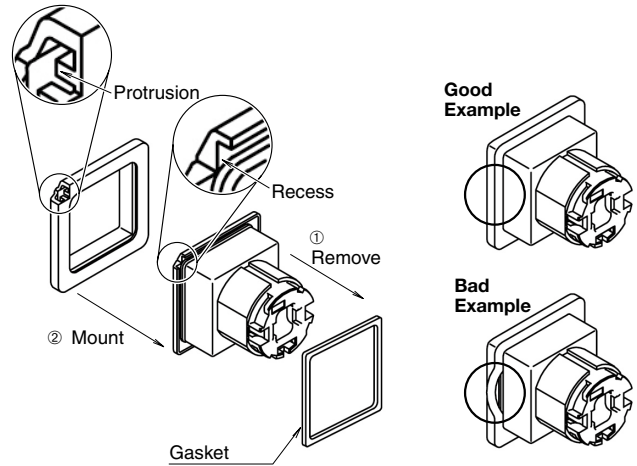

Note: Install the rubber boot before mounting the unit to the panel.

### Maintained Pushbuttons

Do not replace the buttons when the pushbutton is in the maintained position. Replacing the button in the maintained position may damage the internal mechanism. Also, do not remove the contact block with the button in the maintained position. The contact may not operate properly when the contact block is remounted. Make sure to push down fully when using the pushbuttons.

### Pushbuttons and Illuminated Pushbuttons with Switch Guard

Do not apply force to the switch guard when the switch guard is not attached to a panel. When opening the switch guard, do not open more than 180°. The hinge may break.

### Selector Switches

When turning the operator or key, make sure that they are properly turned to each position.

Illuminated Pushbutton
Pilot Light
Pushbutton
Selector
Illuminated Selector
Key Selector
Lever Switch
Buzzer
Accessories
Maintenance Parts
Panel Cut-out
Instructions

# LB/LBW Series Instructions

## Selector Switches with Key

Observe the following instructions to prevent malfunction or damage.

- Insert the key to the bottom of the key hole.
- Do not remove the key from any key retained position.
- Besides the standard key (key number 0H), six other key numbers are available. Use a key of the matching number with the key cylinder. The standard key does not have a key number indication.
- Keys are available in two types.  
Key numbers 0H (standard), 1H, and 2H are reversible keys which can be inserted in two ways.  
Key numbers 3H, 4H, 5H, and 6H are non-reversible keys. Make sure of correct insertion direction.

## Countermeasures against Dim Lighting

Leakage currents through transistors or a contact protection circuit may cause the LED lamp to illuminate dimly even when the output is off.

When the LED lamp is illuminated by a transistor output, take the following measure.

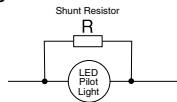

## Leakage Current Shunt Resistor Allotment Table (Recommended)

Leakage Current $I_o$	Shunt resistance R			
	Red (R), White (W)		Green (G)	
	Resistance	Rated Power	Resistance	Rated Power
0.1 mA max.	13k $\Omega$	0.25W	18k $\Omega$	0.25W
0.1 to 0.7 mA	2k $\Omega$	0.25W	2.7k $\Omega$	0.25W

## Noise

LED elements deteriorate due to extraneous noise, resulting in significant decrease in luminance, hue change, or failure of lighting. When such effects are anticipated, take a protection measure shown below. However, measures may differ according to operating environment and condition.

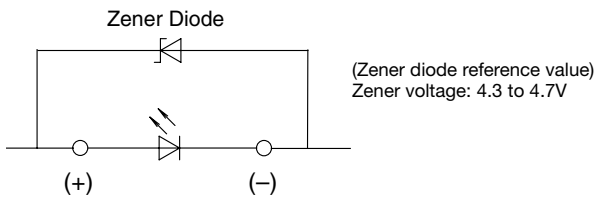

## Static Electricity (UP Series)

UP series are delicate products that may be damaged by static electricity. Make sure to take measures to prevent static electricity.

## Switch Guards

### Opening/closing the Switch Guard

When opening/closing the switch guard while the switch guard is not installed on a panel, make sure to hold the hinge. Holding the base might result in damage. Also do not apply force on the guard in other than open/close directions, otherwise the hinge may be damaged.

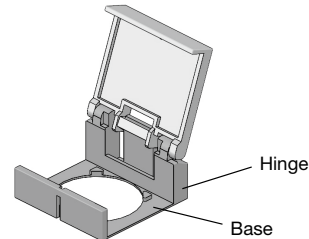

### Rubber Gasket when using LB9Z-K2 Switch Guard (remains open) for Round/Square Units

Choose to use or not to use the rubber gasket for the switch referring to the conditions described below. Note that the degree of protection is IP40 with or without the rubber gasket.

- When the panel thickness is up to 2.8mm  
Install the switch onto the switch guard with rubber gasket, and mount on the panel.

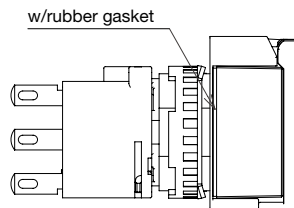

- When the panel thickness is 2.8 to 3.2mm  
Remove the rubber gasket from the switch and install the switch onto the switch guard, and mount on the panel (discard the rubber gasket).

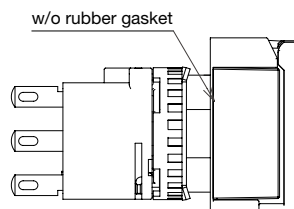

- Single board mounting  
Remove the rubber gasket from the switch and install the switch onto the switch guard, and mount on the panel (discard the rubber gasket).

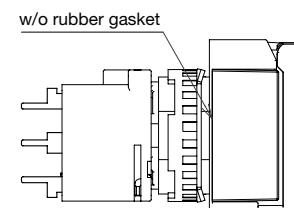



# IDEC CORPORATION

 [www.idec.com](http://www.idec.com)

## Head Office

6-64, Nishi-Miyahara-2-Chome, Yodogawa-ku, Osaka 532-0004, Japan

<b>USA</b>	IDEC Corporation	Tel: +1-408-747-0550	opencontact@idec.com	<b>Hong Kong</b>	IDEC Izumi (H.K.) Co., Ltd.	Tel: +852-2803-8989	info@hk.idec.com
<b>Germany</b>	APEM GmbH	Tel: +49-40-25 30 54 - 0	service@eu.idec.com	<b>China/Shanghai</b>	IDEC (Shanghai) Corporation	Tel: +86-21-6135-1515	idec@cn.idec.com
<b>Singapore</b>	IDEC Izumi Asia Pte. Ltd.	Tel: +65-6746-1155	info@sg.idec.com	<b>China/Shenzhen</b>	IDEC (Shenzhen) Corporation	Tel: +86-755-8356-2977	idec@cn.idec.com
<b>Thailand</b>	IDEC Asia (Thailand) Co., Ltd	Tel: +66-2-392-9765	sales@th.idec.com	<b>China/Beijing</b>	IDEC (Beijing) Corporation	Tel: +86-10-6581-6131	idec@cn.idec.com
<b>Australia</b>	IDEC Australia Pty. Ltd.	Tel: +61-3-8523-5900	sales@au.idec.com	<b>Japan</b>	IDEC Corporation	Tel: +81-6-6398-2527	marketing@idec.co.jp
<b>Taiwan</b>	IDEC Taiwan Corporation	Tel: +886-2-2698-3929	service@tw.idec.com				

Specifications and other descriptions in this brochure are subject to change without notice.  
2018 IDEC Corporation, All Rights Reserved.

EP1609-10 APRIL 2018

