

Data sheet | Item number: 2200-1304

3-conductor through terminal block; with push-button; 1 mm²; with test port; suitable for Ex i applications; side and center marking; for DIN-rail 35 x 15 and 35 x 7.5; Push-in CAGE CLAMP®

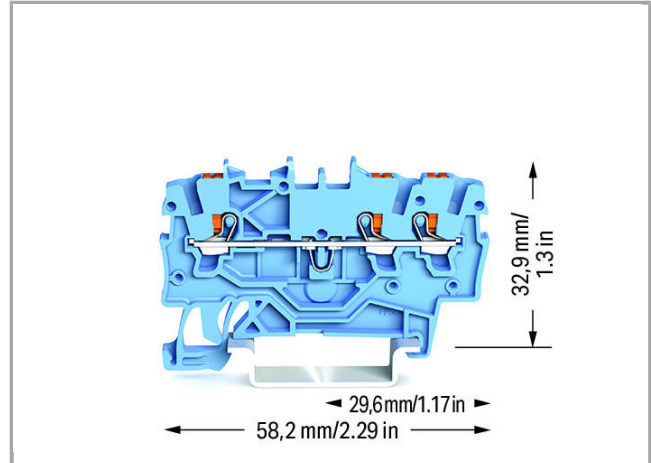

www.wago.com/2200-1304

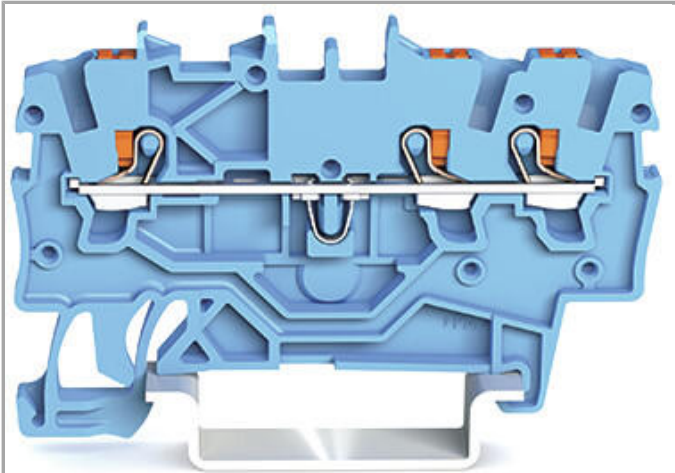

RoHS
Compliant ✓

BOMcheck.net

Color: ■

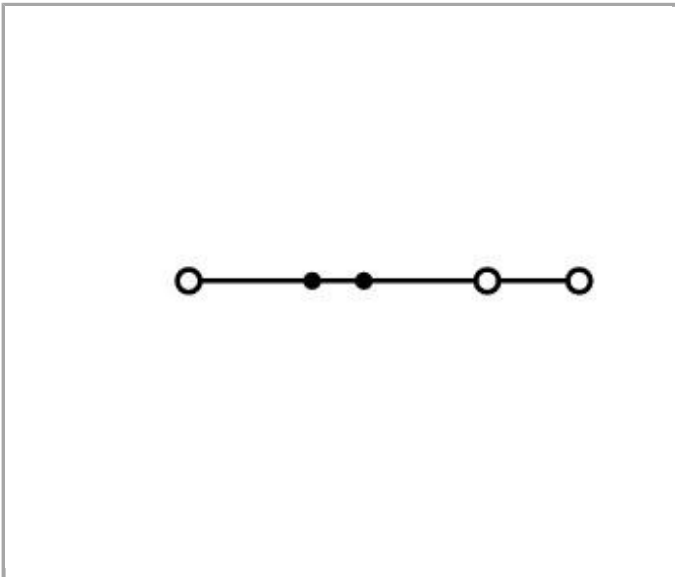

Data

Electrical data

Ratings per IEC/EN 60664-1

Rated voltage (III / 3)

800 V



Rated impulse voltage (III / 3)	8 kV
Rated current	13.5 A
Rated current (2)	18 A

Approvals per UL 1059

Rated voltage UL (Use Group B)	600 V
Rated current UL (Use Group B)	10 A
Rated voltage UL (Use Group C)	600 V
Rated current UL (Use Group C)	10 A

Connection data

Connection technology	Push-in CAGE CLAMP®
Actuation type	Push-in Push-button
Connectable conductor materials	Copper
Nominal cross section	1 mm ²
Solid conductor	0.14 ... 1.5 mm ² / 24 ... 16 AWG
Solid conductor, push-in termination	0.5 ... 1.5 mm ² / 20 ... 16 AWG
Fine-stranded conductor	0.14 ... 1.5 mm ² / 24 ... 16 AWG
Strip length	9 ... 11 mm / 0.35 ... 0.43 inch
Total number of connection points	3
Total number of potentials	1
Number of levels	1
Type of wiring	Front-entry wiring

Geometrical Data

Width	3.5 mm / 0.138 inch
Height from upper-edge of DIN-35 rail	32.9 mm / 1.295 inch
Depth	58.2 mm / 2.291 inch

Mechanical data

Design	horizontal
Type of mounting	DIN-35 rail
Marking level	Center/side marking

Material Data

Color	blue
Insulating material	Polyamide 66 (PA 66)
Fire load	0 MJ



Weight	4.166 g
--------	---------

Commercial data



Country of origin	DE
GTIN	4055143691628
Customs Tariff No.	8536901000

Approvals / Certificates

Ex-Approvals

Logo	Approval	Additional Approval Text	Certificate name
	AEx Underwriters Laboratories Inc.	UL 60079	4788311594
	ATEX Physikalisch Technische Bundesanstalt	IEC 60079-0	PTB 18 ATEX 1003 U
	IECEX Physikalisch Technische Bundesanstalt	IEC 60079	IECEX PTB 18.0010U (Ex eb IIC Gb and Ex eb I Mb)

Country specific Approvals

Logo	Approval	Additional Approval Text	Certificate name
	CCA DEKRA Certification B.V.	EN 60947	NTR NL 7663
	CSA DEKRA Certification B.V.	C22.2	70173737
	KEMA/KEUR DEKRA Certification B.V.	EN 60947	71- 102874

UL-Approvals

Logo	Approval	Additional Approval Text	Certificate name
	cURus Underwriters Laboratories Inc.	UL 1059	4788311592



Compatible products

End plate



Item no.: 2000-1391
End and intermediate plate; 0.7 mm thick

www.wago.com/2000-1391



Item no.: 2000-1392
End and intermediate plate; 0.7 mm thick

www.wago.com/2000-1392

Jumper



Item no.: 2000-402
Push-in type jumper bar; insulated; 2-way; Nominal current 14 A

www.wago.com/2000-402



Item no.: 2000-402/000-005
Push-in type jumper bar; insulated; 2-way; Nominal current 14 A

www.wago.com/2000-402/000-005



Item no.: 2000-402/000-006
Push-in type jumper bar; insulated; 2-way; Nominal current 14 A

www.wago.com/2000-402/000-006



Item no.: 2000-402/000-018
Push-in type jumper bar; insulated; 2-way; Nominal current 14 A

www.wago.com/2000-402/000-018



Item no.: 2000-403
Push-in type jumper bar; insulated; 3-way; Nominal current 14 A

www.wago.com/2000-403



Item no.: 2000-403/000-005
Push-in type jumper bar; insulated; 3-way; Nominal current 14 A

www.wago.com/2000-403/000-005



Item no.: 2000-403/000-006
Push-in type jumper bar; insulated; 3-way; Nominal current 14 A

www.wago.com/2000-403/000-006



















Item no.: 2000-404
Push-in type jumper bar; insulated; 4-way; Nominal current 14 A

















www.wago.com/2000-404













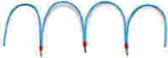





Item no.: 2000-404/000-005
Push-in type jumper bar; insulated; 4-way; Nominal current 14 A

www.wago.com/2000-404/000-005

	Item no.: 2000-404/000-006 Push-in type jumper bar; insulated; 4-way; Nominal current 14 A	www.wago.com/2000-404/000-006
	Item no.: 2000-405 Push-in type jumper bar; insulated; 5-way; Nominal current 14 A	www.wago.com/2000-405
	Item no.: 2000-405/000-005 Push-in type jumper bar; insulated; 5-way; Nominal current 14 A	www.wago.com/2000-405/000-005
	Item no.: 2000-405/000-006 Push-in type jumper bar; insulated; 5-way; Nominal current 14 A	www.wago.com/2000-405/000-006
	Item no.: 2000-405/011-000 Star point jumper; insulated; 3-way (1-3-5); IN = IN terminal block	www.wago.com/2000-405/011-000
	Item no.: 2000-406 Push-in type jumper bar; insulated; 6-way; Nominal current 14 A	www.wago.com/2000-406
	Item no.: 2000-406/000-005 Push-in type jumper bar; insulated; 6-way; Nominal current 14 A	www.wago.com/2000-406/000-005
	Item no.: 2000-406/000-006 Push-in type jumper bar; insulated; 6-way; Nominal current 14 A	www.wago.com/2000-406/000-006
	Item no.: 2000-406/020-000 Delta jumper; insulated; 1-2 3-4 5-6; IN = IN terminal block	www.wago.com/2000-406/020-000
	Item no.: 2000-407 Push-in type jumper bar; insulated; 7-way; Nominal current 14 A	www.wago.com/2000-407
	Item no.: 2000-407/000-005 Push-in type jumper bar; insulated; 7-way; Nominal current 14 A	www.wago.com/2000-407/000-005
	Item no.: 2000-407/000-006 Push-in type jumper bar; insulated; 7-way; Nominal current 14 A	www.wago.com/2000-407/000-006
	Item no.: 2000-408 Push-in type jumper bar; insulated; 8-way; Nominal current 14 A	www.wago.com/2000-408
	Item no.: 2000-408/000-005 Push-in type jumper bar; insulated; 8-way; Nominal current 14 A	www.wago.com/2000-408/000-005
	Item no.: 2000-408/000-006 Push-in type jumper bar; insulated; 8-way; Nominal current 14 A	www.wago.com/2000-408/000-006
	Item no.: 2000-409 Push-in type jumper bar; insulated; 9-way; Nominal current 14 A	www.wago.com/2000-409

	Item no.: 2000-409/000-005 Push-in type jumper bar; insulated; 9-way; Nominal current 14 A	www.wago.com/2000-409/000-005
	Item no.: 2000-409/000-006 Push-in type jumper bar; insulated; 9-way; Nominal current 14 A	www.wago.com/2000-409/000-006
	Item no.: 2000-410 Push-in type jumper bar; insulated; 10-way; Nominal current 14 A	www.wago.com/2000-410
	Item no.: 2000-410/000-005 Push-in type jumper bar; insulated; 10-way; Nominal current 14 A	www.wago.com/2000-410/000-005
	Item no.: 2000-410/000-006 Push-in type jumper bar; insulated; 10-way; Nominal current 14 A	www.wago.com/2000-410/000-006
	Item no.: 2000-433 Push-in type jumper bar; insulated; from 1 to 3; Nominal current 14 A	www.wago.com/2000-433
	Item no.: 2000-433/000-005 Push-in type jumper bar; insulated; from 1 to 3; Nominal current 14 A	www.wago.com/2000-433/000-005
	Item no.: 2000-433/000-006 Push-in type jumper bar; insulated; from 1 to 3; Nominal current 14 A	www.wago.com/2000-433/000-006
	Item no.: 2000-434 Push-in type jumper bar; insulated; from 1 to 4; Nominal current 14 A	www.wago.com/2000-434
	Item no.: 2000-435 Push-in type jumper bar; insulated; from 1 to 5; Nominal current 14 A	www.wago.com/2000-435
	Item no.: 2000-436 Push-in type jumper bar; insulated; from 1 to 6; Nominal current 14 A	www.wago.com/2000-436
	Item no.: 2000-437 Push-in type jumper bar; insulated; from 1 to 7; Nominal current 14 A	www.wago.com/2000-437
	Item no.: 2000-438 Push-in type jumper bar; insulated; from 1 to 8; Nominal current 14 A	www.wago.com/2000-438
	Item no.: 2000-439 Push-in type jumper bar; insulated; from 1 to 9; Nominal current 14 A	www.wago.com/2000-439
	Item no.: 2000-440 Push-in type jumper bar; insulated; from 1 to 10; Nominal current 14 A	www.wago.com/2000-440
	Item no.: 2009-402 Push-in type wire jumper; insulated; wire length 60 mm; Conductor cross section 0.75 mm ² ; suitable for 2000 and 2020 Series rail-mounted terminal blocks	www.wago.com/2009-402
	Item no.: 2009-404 Push-in type wire jumper; insulated; wire length 110 mm; Conductor cross section 0.75 mm ² ; suitable for 2000 and 2020 Series rail-mounted terminal blocks	www.wago.com/2009-404
	Item no.: 2009-406	

	Push-in type wire jumper; insulated; wire length 250 mm; Conductor cross section 0.75 mm ² ; suitable for 2000 and 2020 Series rail-mounted terminal blocks	www.wago.com/2009-406
	Item no.: 210-103 Wire commoning chain; insulated; 50 connections	www.wago.com/210-103
	Item no.: 210-123 Wire commoning chain; insulated; 50 connections	www.wago.com/210-123
ferrule		
	Item no.: 216-241 Ferrule; Sleeve for 0.5 mm ² / 20 AWG; insulated; electro-tin plated; electrolytic copper; gastight crimped; acc. to DIN 46228, Part 4/09.90	www.wago.com/216-241
	Item no.: 216-242 Ferrule; Sleeve for 0.75 mm ² / 18 AWG; insulated; electro-tin plated; electrolytic copper; gastight crimped; acc. to DIN 46228, Part 4/09.90	www.wago.com/216-242
	Item no.: 216-243 Ferrule; Sleeve for 1 mm ² / AWG 18; insulated; electro-tin plated; electrolytic copper; gastight crimped; acc. to DIN 46228, Part 4/09.90	www.wago.com/216-243
Marking accessories		
	Item no.: 2009-110 Marking strips; on reel; not stretchable; plain; snap-on type	www.wago.com/2009-110
	Item no.: 2009-113 WMB-Inline; for Smart Printer; on reel; plain; snap-on type	www.wago.com/2009-113
	Item no.: 2009-113/000-002 WMB-Inline; for Smart Printer; on reel; plain; snap-on type	www.wago.com/2009-113/000-002
	Item no.: 2009-113/000-005 WMB-Inline; for Smart Printer; on reel; plain; snap-on type	www.wago.com/2009-113/000-005
	Item no.: 2009-113/000-006 WMB-Inline; for Smart Printer; on reel; plain; snap-on type	www.wago.com/2009-113/000-006
	Item no.: 2009-113/000-007 WMB-Inline; for Smart Printer; on reel; plain; snap-on type	www.wago.com/2009-113/000-007
	Item no.: 2009-113/000-012 WMB-Inline; for Smart Printer; on reel; plain; snap-on type	www.wago.com/2009-113/000-012
	Item no.: 2009-113/000-017 WMB-Inline; for Smart Printer; on reel; plain; snap-on type	www.wago.com/2009-113/000-017
	Item no.: 2009-113/000-023 WMB-Inline; for Smart Printer; on reel; plain; snap-on type	www.wago.com/2009-113/000-023
	Item no.: 2009-113/000-024 WMB-Inline; for Smart Printer; on reel; plain; snap-on type	www.wago.com/2009-113/000-024



Item no.: 793-3501
WMB marking card; as card; plain; snap-on type

www.wago.com/793-3501

check



Item no.: 2000-510
TOPJOB®S L-type test plug module; modular; for jumper contact slot

www.wago.com/2000-510



Item no.: 2000-511
TOPJOB®S L-type test plug module; modular; for jumper contact slot; 1-pole

www.wago.com/2000-511



Item no.: 2000-549
Spacer module; modular; e.g., for bridging commoned terminal blocks

www.wago.com/2000-549



Item no.: 2000-552
Modular TOPJOB®S connector; modular; for jumper contact slot; 2-pole

www.wago.com/2000-552



Item no.: 2000-553
Modular TOPJOB®S connector; modular; for jumper contact slot; 3-pole

www.wago.com/2000-553



Item no.: 2000-554
Modular TOPJOB®S connector; modular; for jumper contact slot; 4-pole

www.wago.com/2000-554



Item no.: 2000-555
Modular TOPJOB®S connector; modular; for jumper contact slot; 5-pole

www.wago.com/2000-555



Item no.: 2000-556
Modular TOPJOB®S connector; modular; for jumper contact slot; 6-pole

www.wago.com/2000-556



Item no.: 2000-557
Modular TOPJOB®S connector; modular; for jumper contact slot; 7-pole

www.wago.com/2000-557



Item no.: 2000-558
Modular TOPJOB®S connector; modular; for jumper contact slot; 8-pole

www.wago.com/2000-558



Item no.: 2000-559
Modular TOPJOB®S connector; modular; for jumper contact slot; 9-pole

www.wago.com/2000-559



Item no.: 2000-560
Modular TOPJOB®S connector; modular; for jumper contact slot; 10-pole

www.wago.com/2000-560



Item no.: 2009-174
Test plug adapter; for 4 mm Ø test plugs; for testing TOPJOB®S rail-mounted terminal blocks

www.wago.com/2009-174



Item no.: 2009-182
Testing tap; for max. 2.5 mm²; tool-free connection for individual test wires 0.08 - 2.5 mm

www.wago.com/2009-182



Item no.: 210-136
Test plug; 2 mm Ø; with 500 mm cable

www.wago.com/210-136



Item no.: 210-137
Test plug; 2.3 mm Ø; with 500 mm cable

www.wago.com/210-137

tools



Item no.: 210-647
Operating tool with partially insulated shaft; Blade (2.5 x 0.4) mm; short

www.wago.com/210-647



Item no.: 210-648
Operating tool with partially insulated shaft; Blade (2.5 x 0.4) mm; short; angled

www.wago.com/210-648



Item no.: 210-719
Operating tool with partially insulated shaft; Type 1, blade (2.5 x 0.4) mm

www.wago.com/210-719

Carrier rail



Item no.: 210-112
Steel carrier rail; 35 x 7.5 mm; 1 mm thick; 2 m long; slotted; according to EN 60715; "Hole width 25 mm www.wago.com/210-112



Item no.: 210-113
Steel carrier rail; 35 x 7.5 mm; 1 mm thick; 2 m long; unslotted; according to EN 60715 www.wago.com/210-113



Item no.: 210-114
Steel carrier rail; 35 x 15 mm; 1.5 mm thick; 2 m long; unslotted; similar to EN 60715 www.wago.com/210-114



Item no.: 210-115
Steel carrier rail; 35 x 7.5 mm; 1 mm thick; 2 m long; slotted; according to EN 60715; "Hole width 18 mm www.wago.com/210-115



Item no.: 210-118
Steel carrier rail; 35 x 15 mm; 2.3 mm thick; 2 m long; unslotted; according to EN 60715 www.wago.com/210-118



Item no.: 210-196
Aluminum carrier rail; 35 x 8.2 mm; 1.6 mm thick; 2 m long; unslotted; similar to EN 60715 www.wago.com/210-196



Item no.: 210-197
Steel carrier rail; 35 x 15 mm; 1.5 mm thick; 2 m long; slotted; similar to EN 60715 www.wago.com/210-197



Item no.: 210-198
Copper carrier rail; 35 x 15 mm; 2.3 mm thick; 2 m long; unslotted; according to EN 60715 www.wago.com/210-198

Downloads

Documentation

Bid Text

2200-1304	docx	Download
	15.1 kB	

CAD/CAE - Smart Data

CAD data

3D Download 2200-1304	URL	Download
-----------------------	-----	----------

Subject to changes.