

# MGA-25203

## 5.1 - 5.9 GHz WiFi and WiMAX Power Amplifier (3x3mm)



### Data Sheet

#### Description

Avago Technologies MGA-25203 linear power amplifier is designed for mobile and fixed wireless data applications in the 5.1 to 5.9 GHz frequency ranges. The PA is optimized for IEEE 802.11a/n WLAN and 802.16 WiMAX applications. The PA exhibits flat gain and good match while providing linear power efficiency to meet stringent mask conditions. It utilizes Avago Technologies proprietary GaAs Enhancement-mode pHEMT technology for superior performance across voltage and temperature levels.

The MGA-25203 is packaged in a 3x3x1 mm size for space-constrained applications.

#### Applications

- Portable WiFi and WiMAX applications
- WiFi and WiMAX Access points

#### Functional Block Diagram

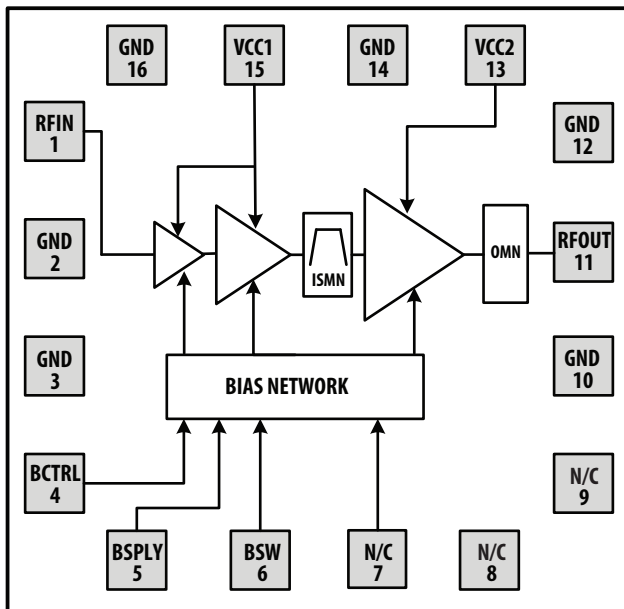

#### Features

- Advanced GaAs E-pHEMT
- 50 Ω all RF ports
- Full performance across entire 5.1-5.9GHz
- Operates from 4.9-5.9 GHz
- Integrated CMOS compatible pins for shutdown
- 3 to 5V supply
- ESD protection all ports above 1000V HBM
- Small size: 3 x 3 x 1 mm
- Stable under all loads or conditions
- -40°C to +85°C operation
- Integrated DC blocking capacitors for Input and Output pins

#### At 5.4GHz

- Meets all IEEE 802.11n masks at 23 dBm Pout with 3.3V and 425mA
- EVM of -34dB (2.0%) at 64QAM, 54Mbps @ Pout of 23dBm
- Gain of 30dB
- PAE of 13%

#### Device Marking Instruction

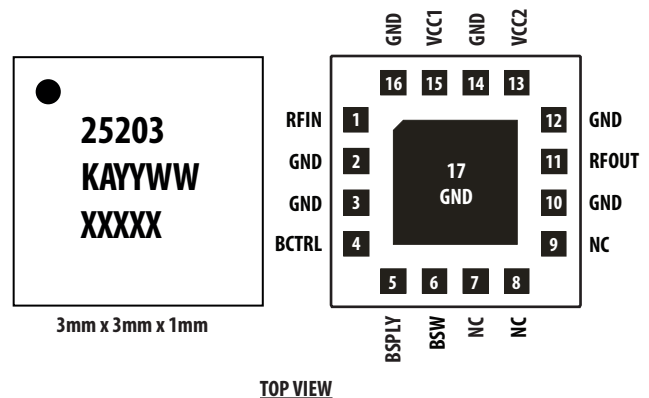

"25203" = Product Code  
 "KA" = Korea ASE  
 "YY" = Year code indicates the year of manufacture  
 "WW" = Workweek code indicates the workweek of manufacture  
 "XXXXX" = Last 5 digit of assembly lot number

## Electrical Specifications

### Absolute Minimum and Maximum Ratings

**Table 1. Minimum and Maximum Ratings**

Parameter		Specifications				Comments
Description	Pin	Min.	Typical	Max.	Unit	
Supply Voltage	VCC1 VCC2	3	3.3	5.5	V	
Bias Supply	BSPLY	3	3.3	5.5	V	
Bias Control	BCTRL	1.65	2.8	5.5	V	
Bias ON/OFF	BSW	1.65	1.8	5.5	V	
RF Input Power	RFIN			15	V	Using 64QAM
MSL				MSL3		
Channel Temperature				150	°C	
Storage Temperature		-65		150	°C	

**Table 2. Operating Range**

Parameter		Specifications				Comments
Description	Pin	Min.	Typical	Max.	Unit	
Supply Voltage	VCC1 VCC2	3	3.3	5	V	
Bias Supply	BSPLY	3	3.3	5	V	
			20		mA	
Bias Control	BCTRL	2.75	2.8	2.85	V	
			0.68		mA	
Bias ON/OFF	BSW	1.65	1.8	2.2	V	
			36		uA	
RF Output Power	RFOUT			23	dBm	Using 64QAM
Frequency Range		5.1		5.9	GHz	
Thermal Resistance, $\theta_{ch-b}$			23.4		°C/W	Channel to board
Case Temperature		-40		+85	°C	

## WLAN (802.11 a) Electrical Specifications

All data measured on an FR4 demo board at  $V_{cc1} = V_{cc2} = 3.3V$ ,  $T_c = 25^{\circ}C$ ,  $50 \Omega$  at all ports. Unless otherwise specified, all data is taken at 54Mbps 64QAM modulated signal per IEEE 802.11a with 20MHz BW at 4.9 - 5.9GHz. This module is intended for frequency band 5.1-5.9GHz. The following data from 4.9 to 5.1GHz shows that the PA is fully functional with degraded performance.

**Table 3. RF Electrical Characteristics**

Parameter	Performance				Comments	
	Min.	Typical	Max.	Unit		
Input Return Loss	-	-8	-	dB		
Gain Flatness	-	1	-	dB	Over any 20MHz	
Gain Variation ( $V_{CC}$ )	-1	-	1	dB	3V to 5V	
5.4-5.9 GHz	EVM	-	-32	-30	dB	$V_{cc}=3.3V$
		-	-36	-32	dB	$V_{cc}=5.0V$
	Pout, SEM Compliant	+23	-	-	dBm	IEEE 802.11a
	Total DC Current	-	425	580	mA	Pout=23dBm
	Gain	27	30	33	dB	
5.1-5.3 GHz	EVM	-	-30	-	dB	$V_{cc}=3.3V$
		-	-32	-	dB	$V_{cc}=5.0V$
	Pout, SEM Compliant	+23	-	-	dBm	IEEE 802.11a
	Total DC Current	-	443	-	mA	Pout=23dBm
	Gain	-	27	-	dB	
4.9-5.0 GHz	EVM	-	-26	-	dB	$V_{cc}=3.3V$
		-	-28	-	dB	$V_{cc}=5.0V$
	Pout, SEM Compliant	-	22	-	dBm	IEEE 802.11a
	Total DC Current	-	468	-	mA	Pout=23dBm
	Gain	-	23	-	dB	
P1dB	-	29	-	dBm	CW Single Tone	
Psat	-	30	-	dBm	CW Single Tone	
Settling Time	0.2	0.5	-	uS		
Icc leakage current	-	10	40	uA		

## Selected performance plots

5.4 – 5.9GHz

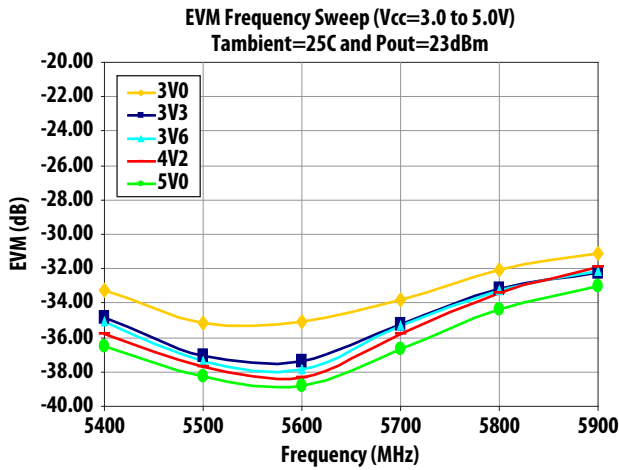

Figure 1. EVM Frequency Sweep at 25C and Pout=23dBm over Vcc

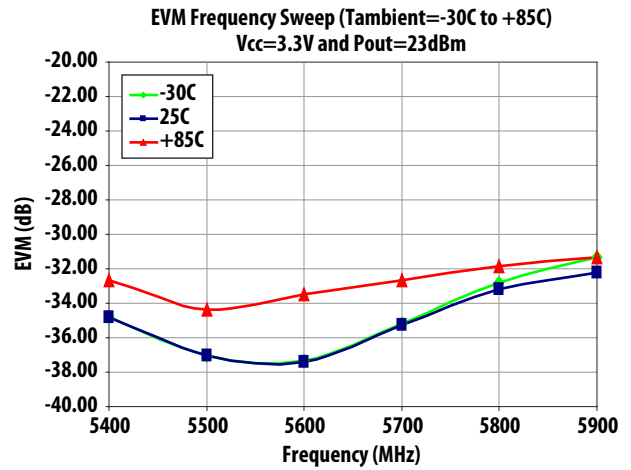

Figure 2. EVM Frequency Sweep at Vcc=3.3V and Pout=23dBm over Tambient

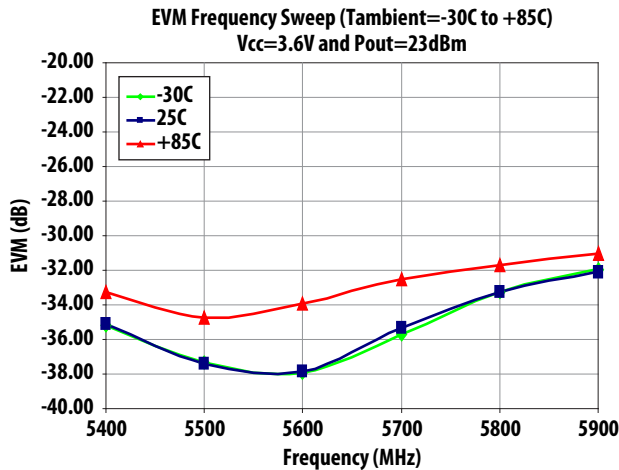

Figure 3. EVM Frequency Sweep at Vcc=3.6V and Pout=23dBm over Tambient

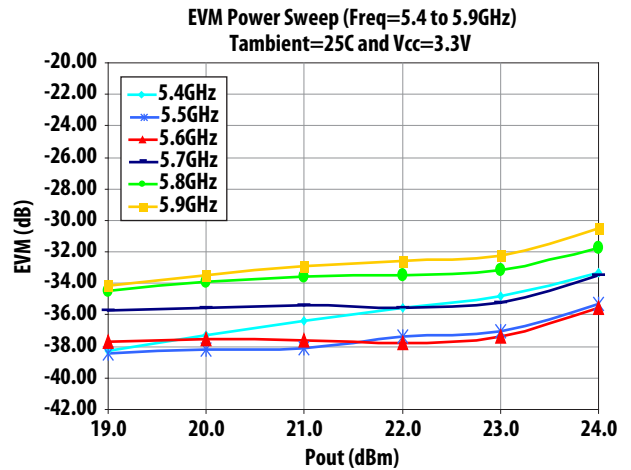

Figure 4. EVM Power Sweep at Vcc=3.3V and 25C over Frequency

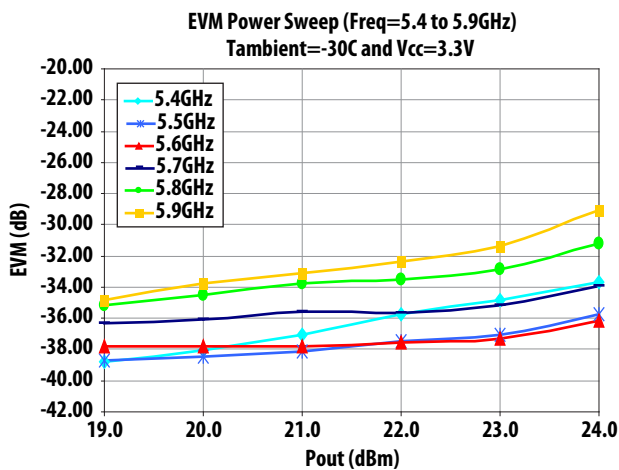

Figure 5. EVM Power Sweep at Vcc=3.3V and -30C over Frequency

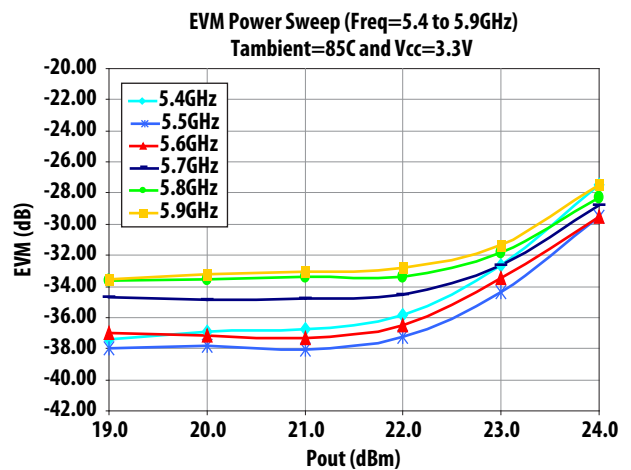

Figure 6. EVM Power Sweep at Vcc=3.3V and +85C over Frequency

## Selected performance plots

5.4 – 5.9GHz (Cont.)

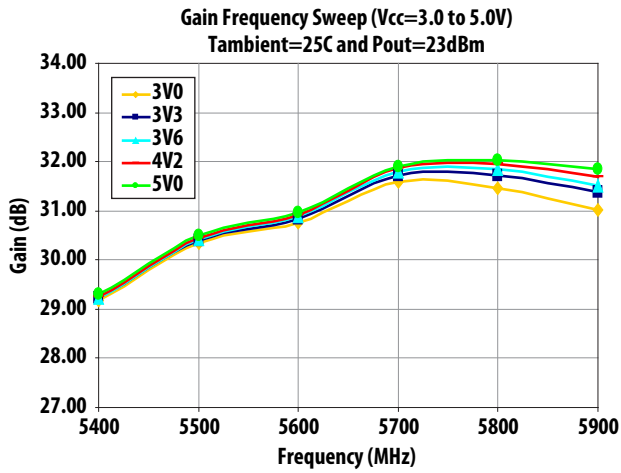

Figure 7. Gain Frequency Sweep at 25C and Pout=25dBm over Vcc

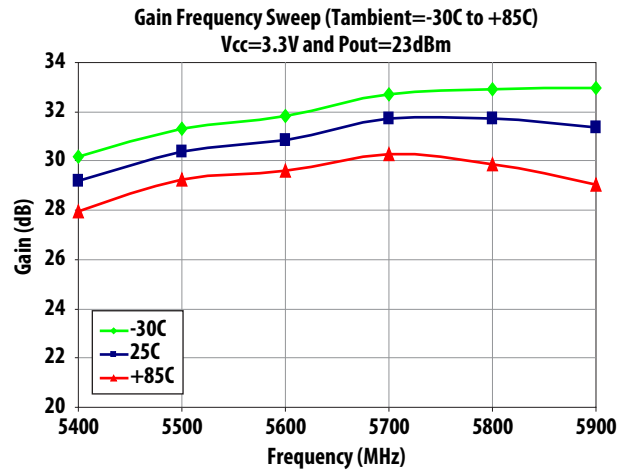

Figure 8. Gain Frequency Sweep at Vcc=3.3V and Pout=25dBm over Tambient

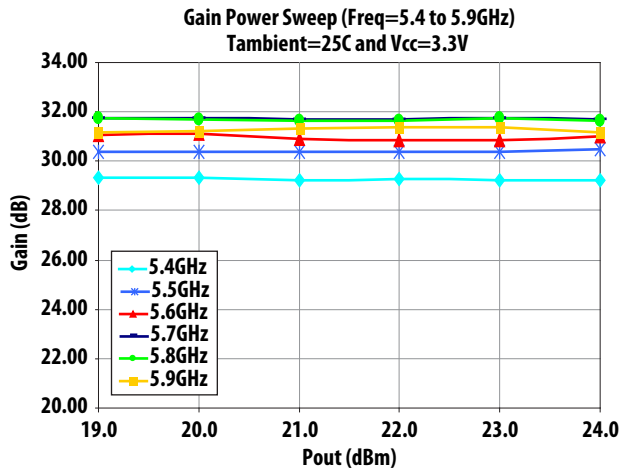

Figure 9. Gain Power Sweep at Vcc=3.3V and 25C over Frequency

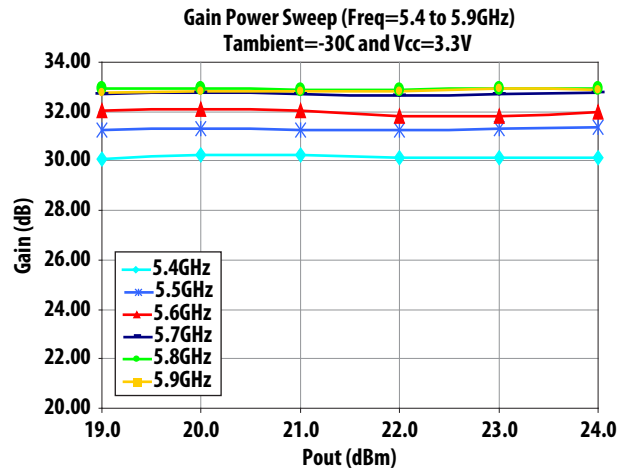

Figure 10. Gain Power Sweep at Vcc=3.3V and -30C over Frequency

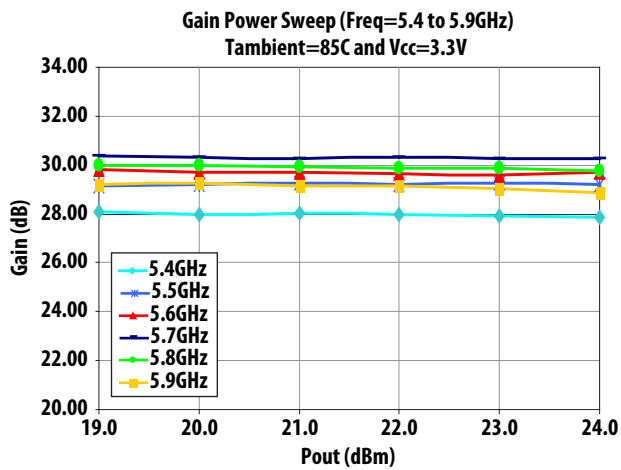

Figure 11. Gain Power Sweep at Vcc=3.3V and +85C over Frequency

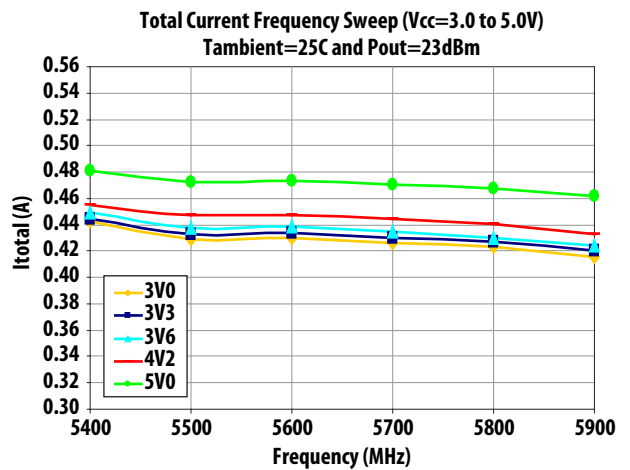

Figure 12. Total Current Frequency Sweep at 25C and Pout=25dBm over Vcc

## Selected performance plots

### 5.4 – 5.9GHz (Cont.)

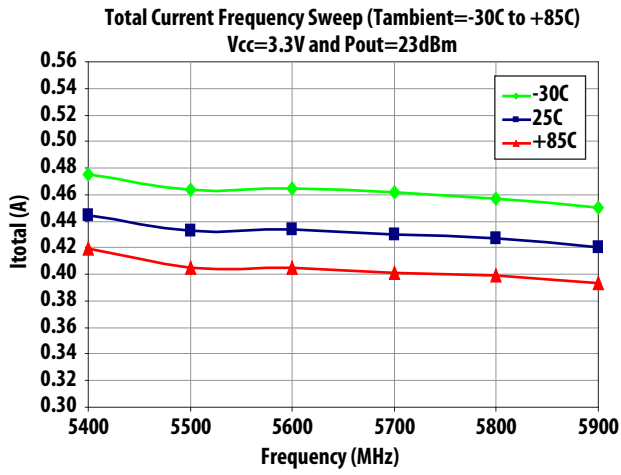

Figure 13. Total Current Frequency Sweep at 3.3V and Pout=25dBm over Tambient

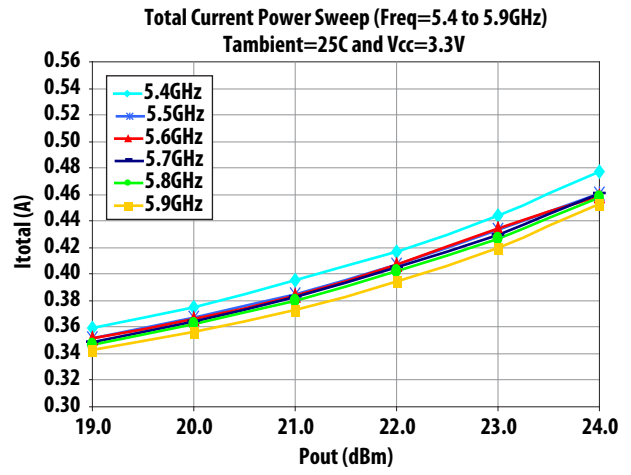

Figure 14. Total Current Power Sweep at 3.3V and 25C over Frequency

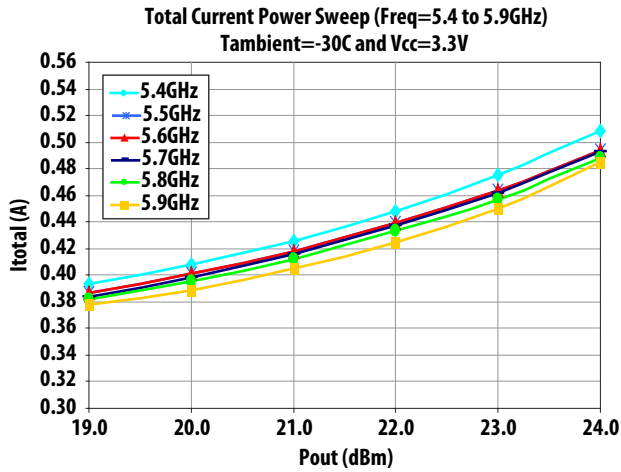

Figure 15. Total Current Power Sweep at 3.3V and -30C over Frequency

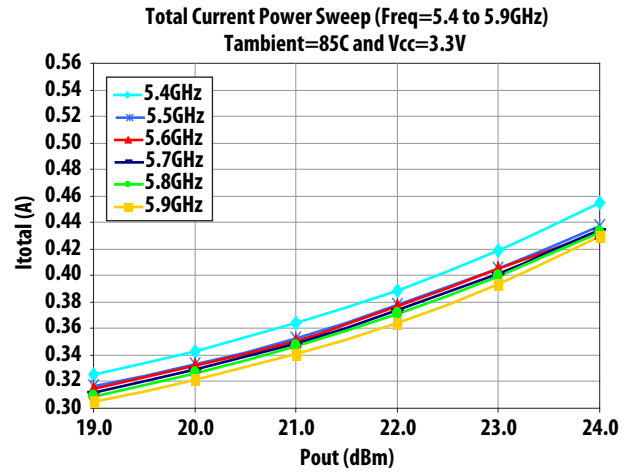

Figure 16. Total Current Power Sweep at 3.3V and +85C over Frequency

## Selected performance plots

4.9 – 5.3GHz

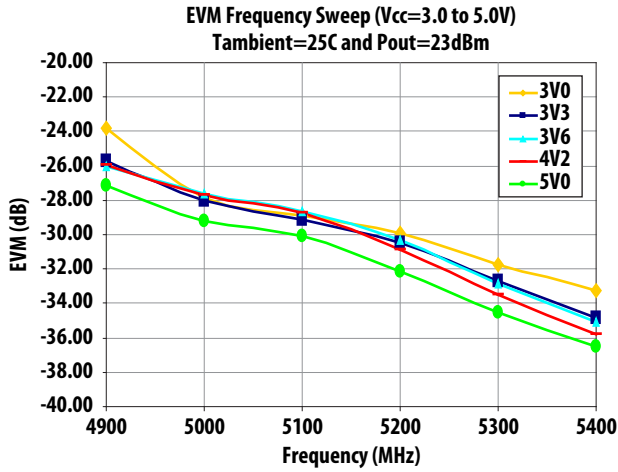

Figure 17. EVM Frequency Sweep at 25C and Pout=23dBm over Vcc

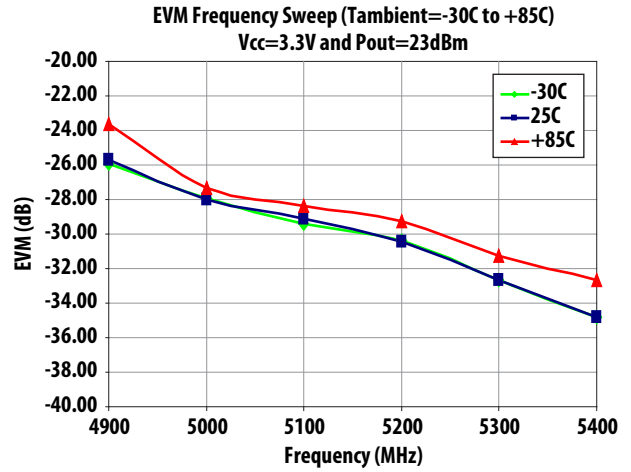

Figure 18. EVM Frequency Sweep at Vcc=3.3V and Pout=23dBm over Tambient

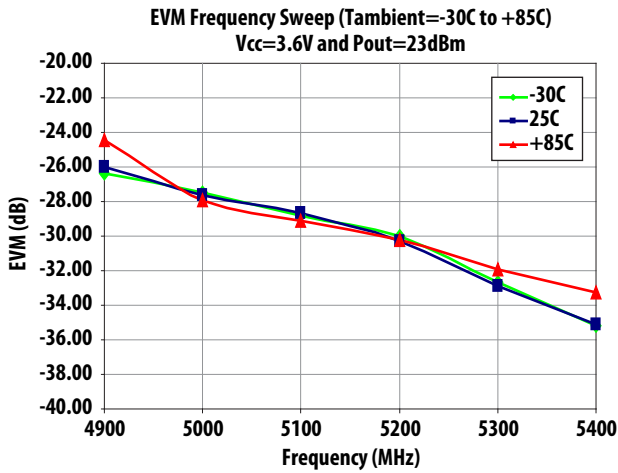

Figure 19. EVM Frequency Sweep at Vcc=3.6V and Pout=23dBm over Tambient

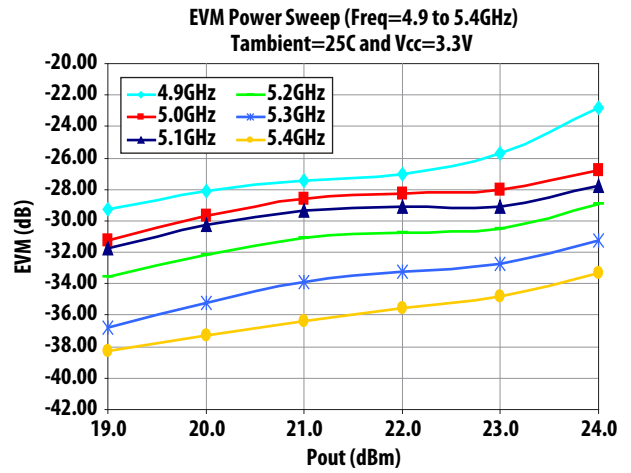

Figure 20. EVM Power Sweep at Vcc=3.3V and 25C over Frequency

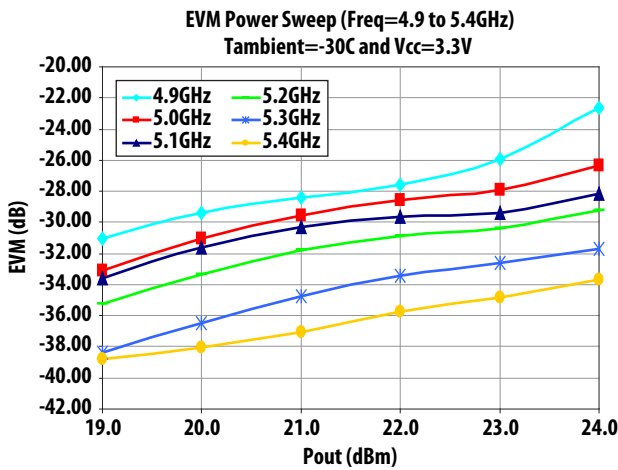

Figure 21. EVM Power Sweep at Vcc=3.3V and -30C over Frequency

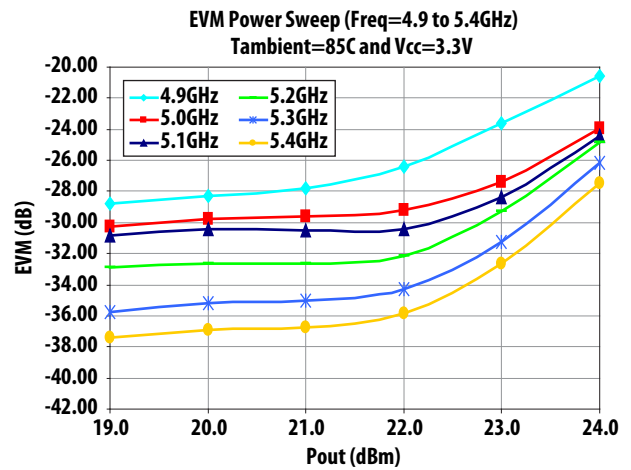

Figure 22. EVM Power Sweep at Vcc=3.3V and +85C over Frequency

## Selected performance plots

### 4.9 – 5.3GHz (Cont.)

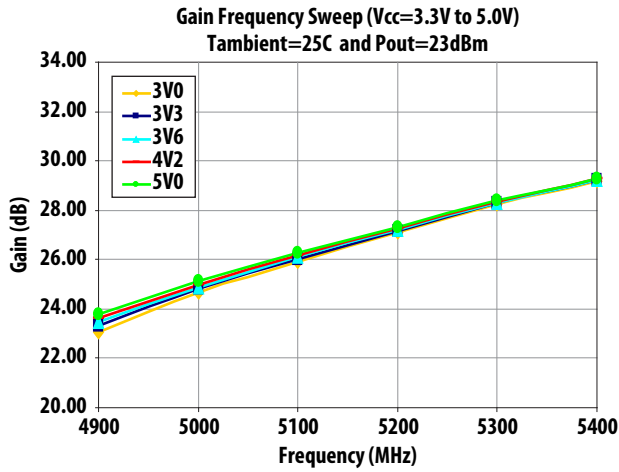

Figure 23. Gain Frequency Sweep at 25C and Pout=23dBm over Vcc

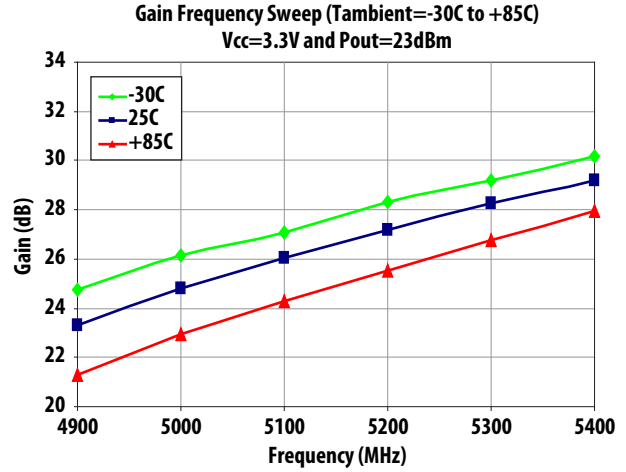

Figure 24. Gain Frequency Sweep at Vcc=3.3V and Pout=23dBm over Tambient

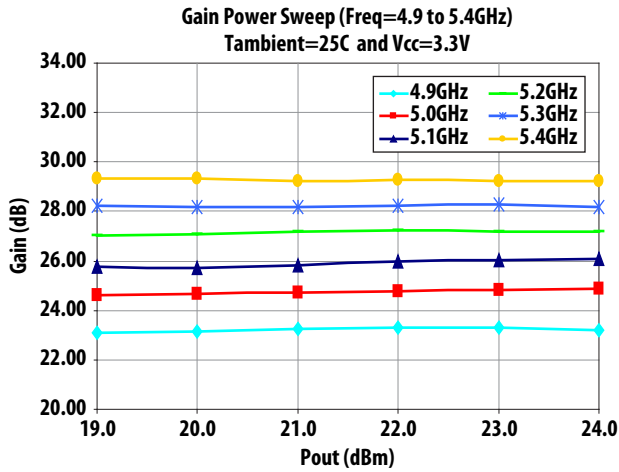

Figure 25. Gain Power Sweep at Vcc=3.3V and 25C over Frequency

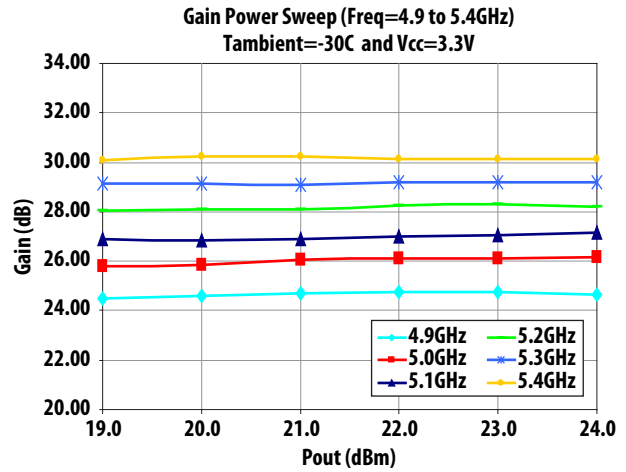

Figure 26. Gain Power Sweep at Vcc=3.3V and -30C over Frequency

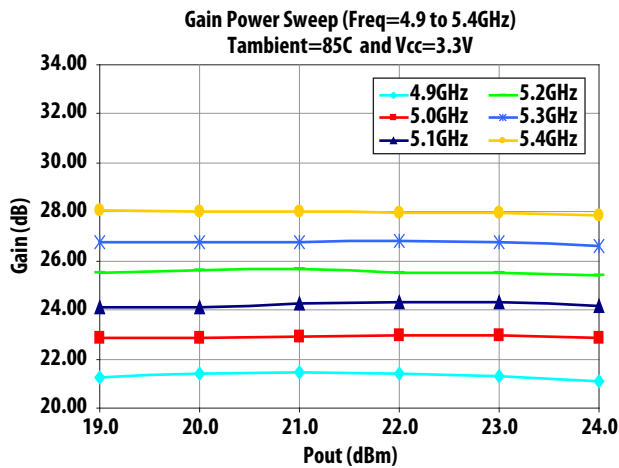

Figure 27. Gain Power Sweep at Vcc=3.3V and +85C over Frequency



## Selected performance plots

### 4.9 – 5.3GHz (Cont.)

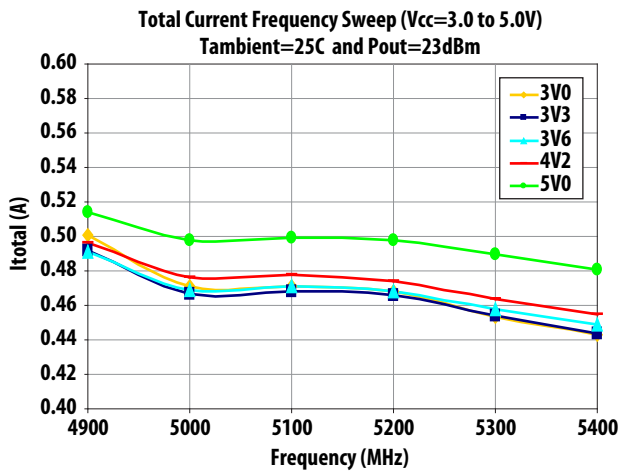

Figure 28. Total Current Frequency Sweep at 25C and Pout=23dBm over Vcc

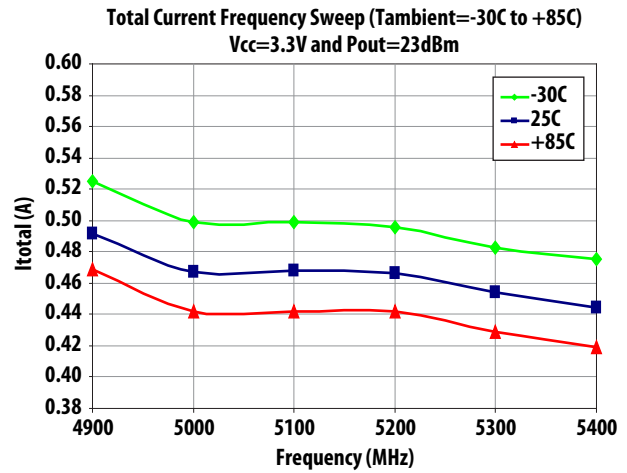

Figure 29. Total Current Frequency Sweep at 3.3V and Pout=23dBm over Tambient

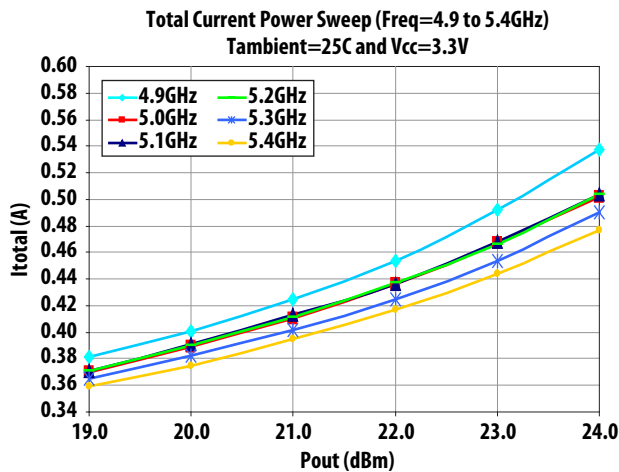

Figure 30. Total Current Power Sweep at 3.3V and 25C over Frequency

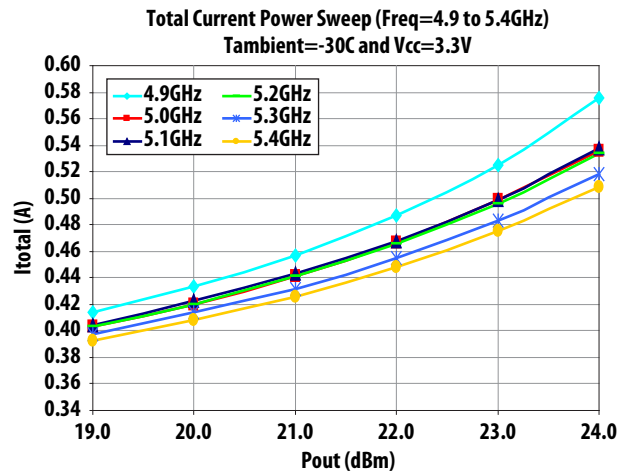

Figure 31. Total Current Power Sweep at 3.3V and -30C over Frequency

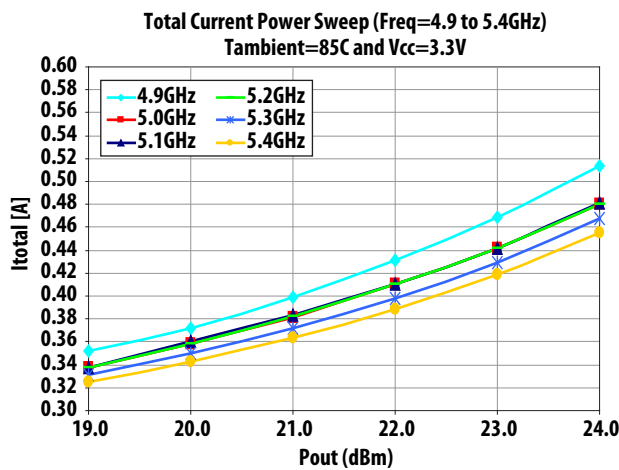

Figure 32. Total Current Power Sweep at 3.3V and +85C over Frequency

## Evaluation Board Description

**Table 4. Evaluation Board Pin Description**

Top Pin No.	Function	Bottom Pin No.	Function
1	VCC2	2	VCC2_S
3	B_SPLY	4	GND
5	VCC1	6	GND
7	NC	8	GND
9	NC	10	GND
11	NC	12	GND
13	NC	14	B_SW
15	B_CTRL	16	GND
17	NC	18	GND
19	NC	20	GND

Recommended turn on sequence

- Apply VCC1 and VCC2 3.3V
- Apply BSPLY 3.3V
- Apply BCTRL 2.8V
- Apply BSW 1.8V
- Apply RF In, not to exceed 15dBm

**Table 5. Typical Test Conditions**

Pin	HPM	Description
VCC1,2	3.3V	Supply Voltage
B_SPLY	3.3V	Bias Voltage
B_CTRL	2.8V	Bias Control
B_SW	1.8V	PA Enable

Notes: VCC1, VCC2 and B\_SPLY can be tied together to reduce supply voltages, but B\_CTRL needs to be a regulated voltage which is optimized for 2.8V.

### Demoboard Top Pins

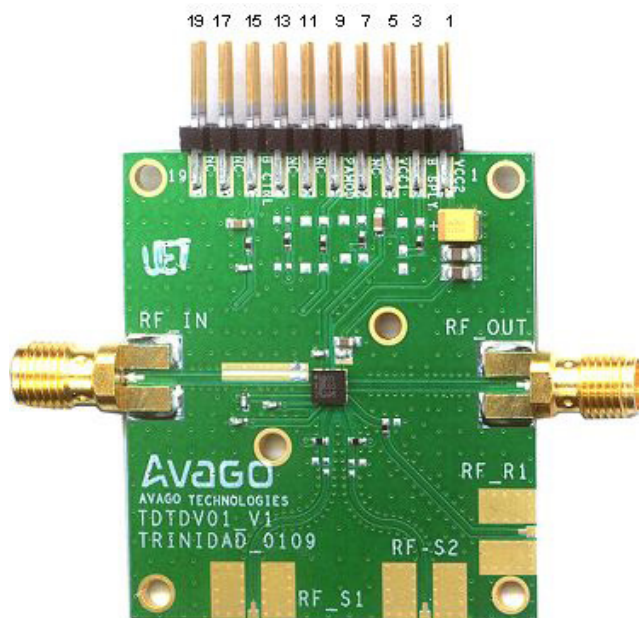

### Demoboard Bottom Pins

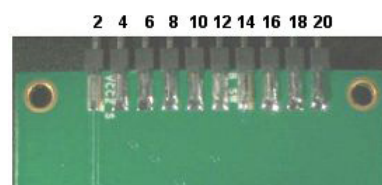

# Application Circuit MGA-25203

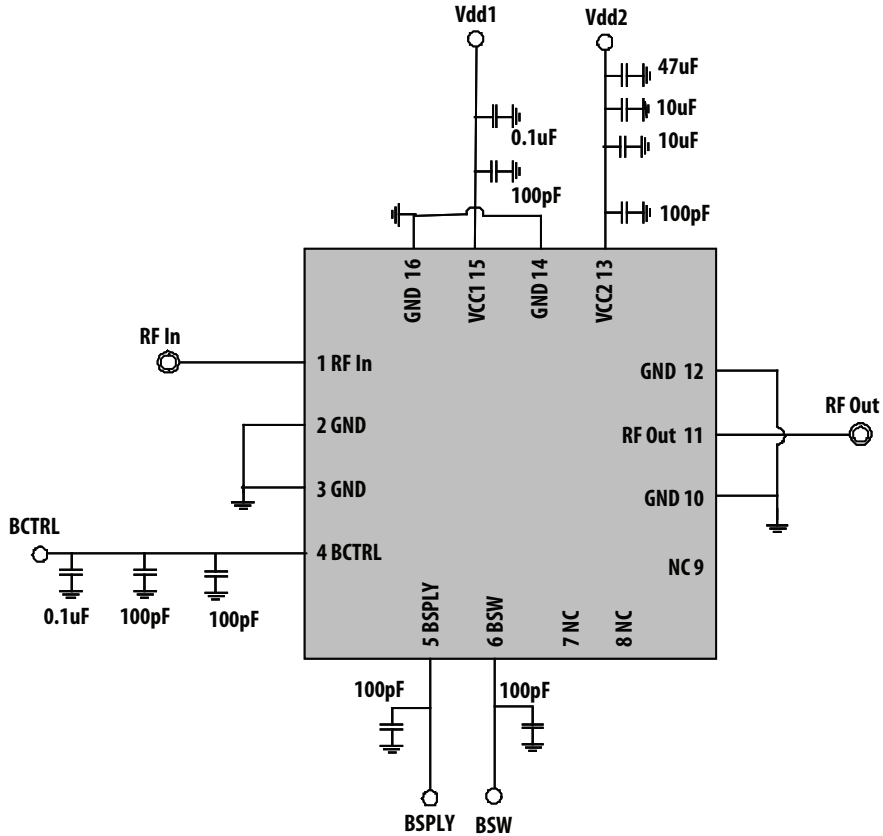

## Using 3.3V or 5V Supply and tying Vcc1, Vcc2, BSPLY and BCTRL

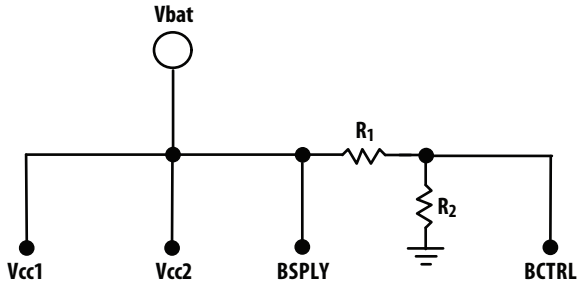

Notes: BCTRL regulates the device current, thus R1 and R2 should have good tolerance rating. If available, a voltage regulator is the preferred method of bias.

In this example we set R2 at 40KOhm and solve for R1 with simple voltage divider equation. Note this method will cause some leakage current through R2.

### 3.3V Example :

$$V_{BCTRL} = \frac{R_2}{R_1 + R_2} * V_{BATT}$$

$$2.8V = \frac{40K\Omega}{R_1 + 40K\Omega} * 3.3V$$

$$R_1 = 7K\Omega$$

$$R_2 = 40K\Omega$$

### Given :

$$V_{BCTRL} = 2.8V$$

$$V_{BAT} = 3.3V$$

$$R_2 = 40K\Omega$$

$$R_1 = ?$$

### 5.0V Example :

$$V_{BCTRL} = \frac{R_2}{R_1 + R_2} * V_{BATT}$$

$$2.0V = \frac{20K\Omega}{R_1 + 20K\Omega} * 5.0V$$

$$R_1 = 30K\Omega$$

$$R_2 = 20K\Omega$$

### Given :

$$V_{BCTRL} = 2.0V$$

$$V_{BAT} = 5.0V$$

$$R_2 = 20K\Omega$$

$$R_1 = ?$$

## Land Pattern

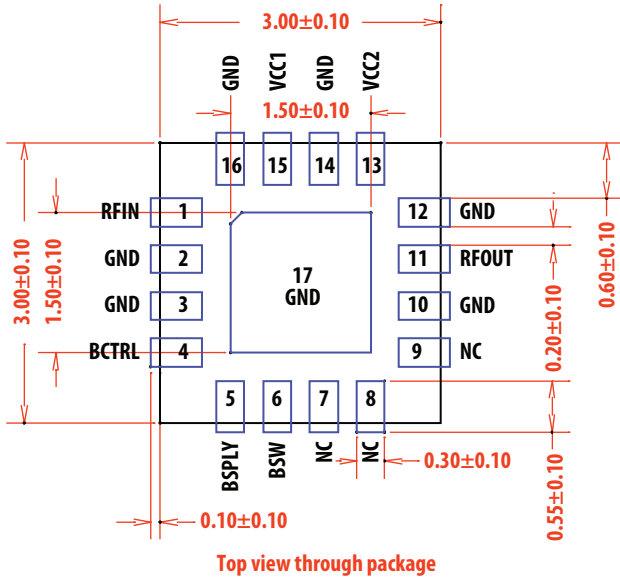

Figure 33. Recommended footprint

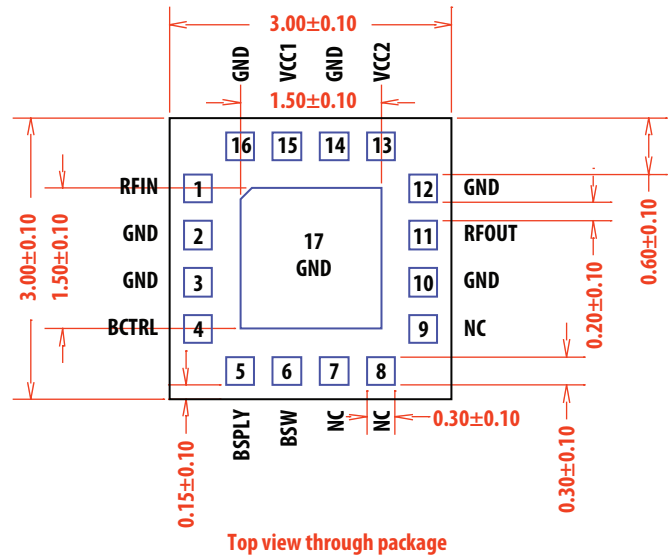

Figure 34. Package dimensions

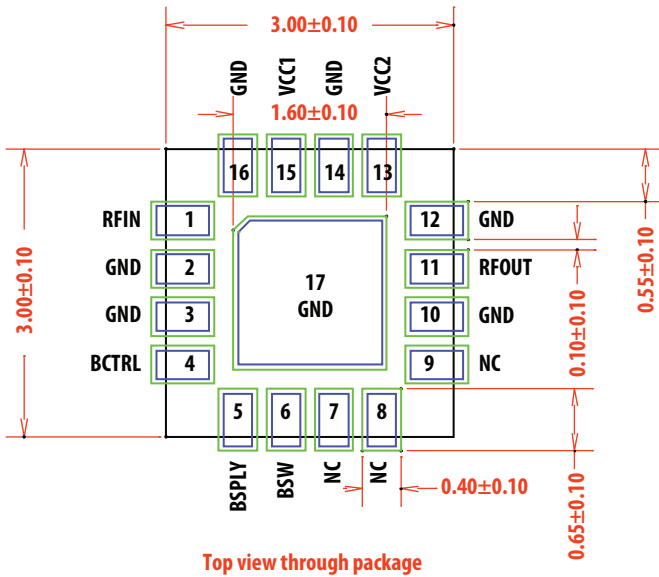

Figure 35. Recommended mask opening

- Notes:
1. All units are in millimeters
  2. Package is symmetrical

## Ordering Information

Part Number	No. of Devices	Container
MGA-25203-BLKG	100	7" Reel
MGA-25203-TR1G	3000	13" Reel

## Package Dimensions

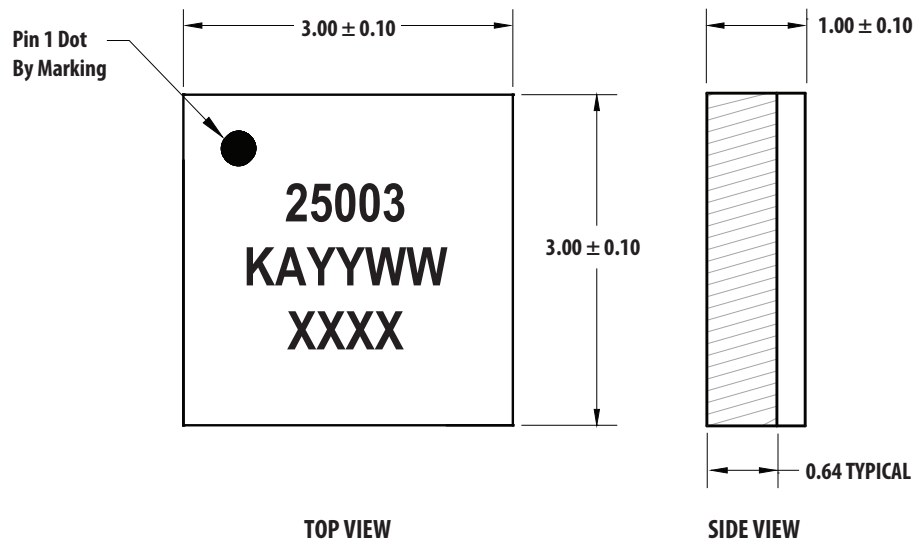

### Note

1. All dimensions are in millimeters.
2. Dimensions are inclusive of plating.
3. Dimensions are exclusive of mold flash and metal burr.

## Device Orientation

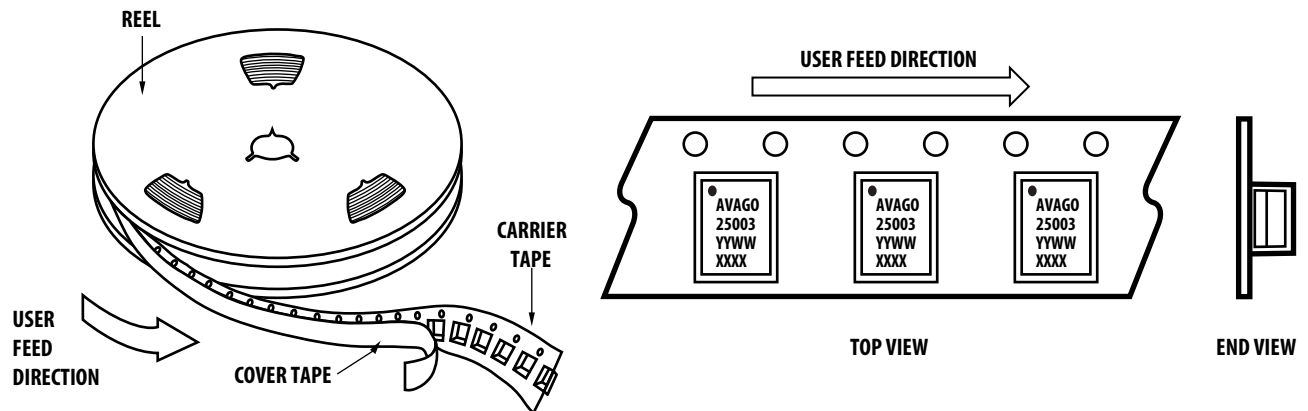

# Tape and Reel Information

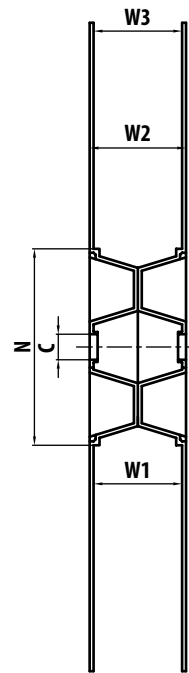
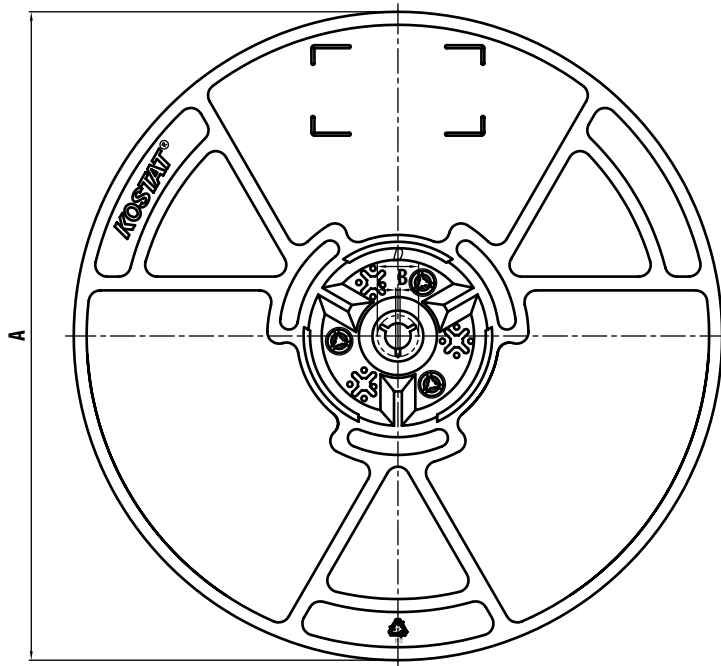

Size	12mm
A	330 <sup>+2.0</sup> <sub>-2.0</sub>
B	1.5min.
C	13.0 <sup>+0.5</sup> <sub>-0.2</sub>
D	20.2min.
N	100 <sup>+3.0</sup> <sub>-0.0</sub>
W1	12.4 <sup>+3.0</sup> <sub>-0.0</sub>
W2	16.4 <sup>+2.0</sup> <sub>-2.0</sub>
W3	13.65 <sup>+1.75</sup> <sub>-0.75</sub>

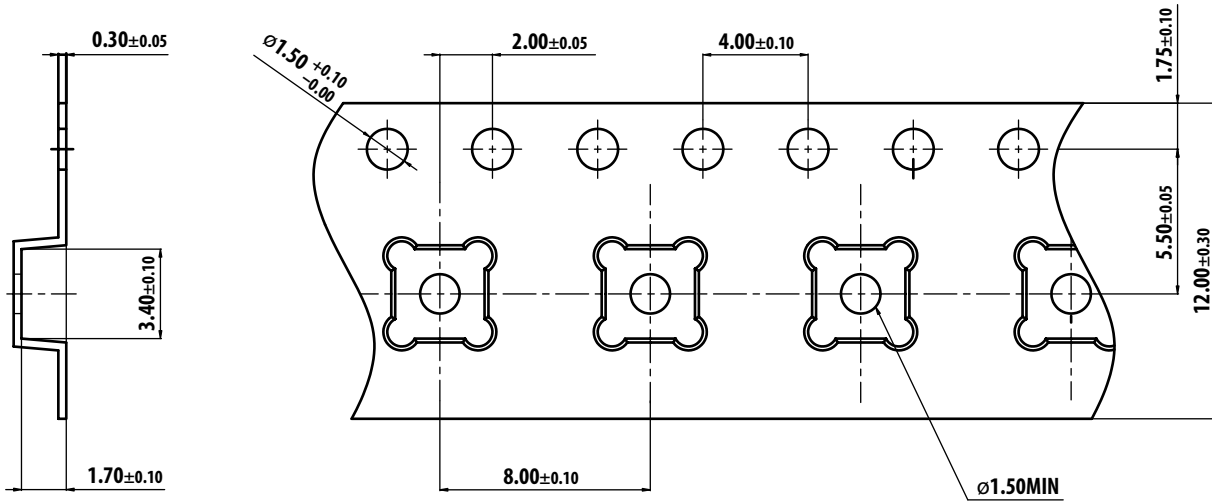
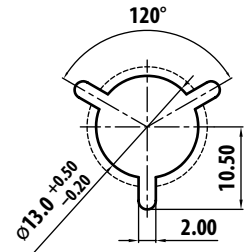

## Handling and Storage

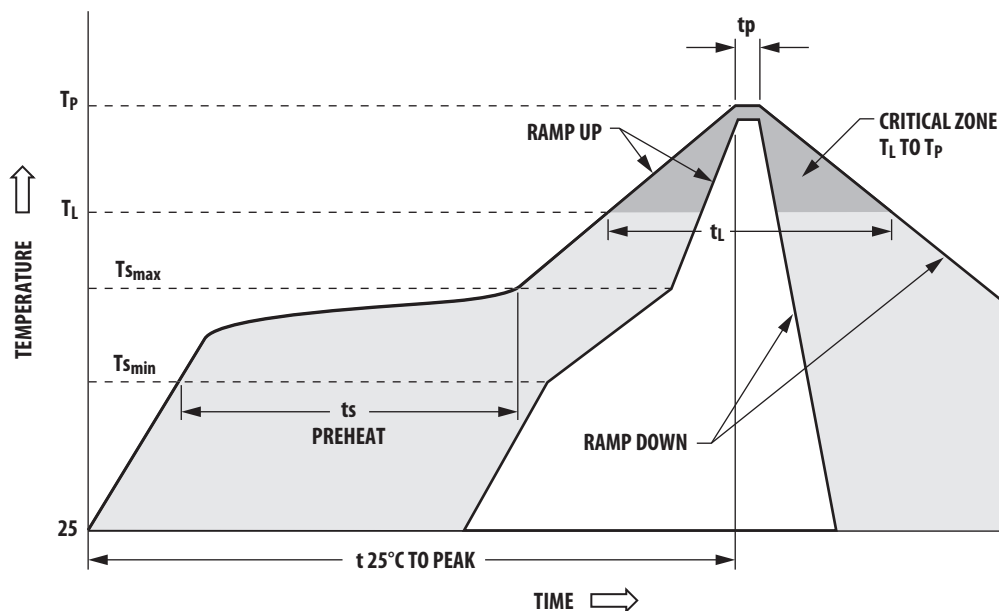

### Typical SMT Reflow Profile for Maximum Temperature = $260 \pm 0/-5^\circ\text{C}$

Profile Feature	Sn-Pb Solder	Pb-Free Solder
Average ramp-up rate (TL to TP)	3°C/sec max	3°C/sec max
Preheat		
– Temperature Min (T <sub>min</sub> )	100°C	100°C
– Temperature Max (T <sub>max</sub> )	150°C	150°C
– Time (mon to max) (t <sub>s</sub> )	60-120 sec	60-180 sec
T <sub>max</sub> to TL		
– Ramp-up Rate		3°C/sec max
Time maintained above:		
– Temperature (TL)	183°C	217°C
– Time (TL)	60-150 sec	60-150 sec
Peak temperature (T <sub>p</sub> )	240 $\pm 0/-5^\circ\text{C}$	260 $\pm 0/-5^\circ\text{C}$
Time within 5°C of actual Peak Temperature (t <sub>p</sub> )	10-30 sec	10-30 sec
Ramp-down Rate	6°C/sec max	6°C/sec max
Time 25°C to Peak Temperature	6 min max	8 min max

For product information and a complete list of distributors, please go to our web site: [www.avagotech.com](http://www.avagotech.com)

Avago, Avago Technologies, and the A logo are trademarks of Avago Technologies in the United States and other countries. Data subject to change. Copyright © 2005-2014 Avago Technologies. All rights reserved. AV02-1961EN - March 6, 2014

**AVAGO**  
TECHNOLOGIES