

E20454

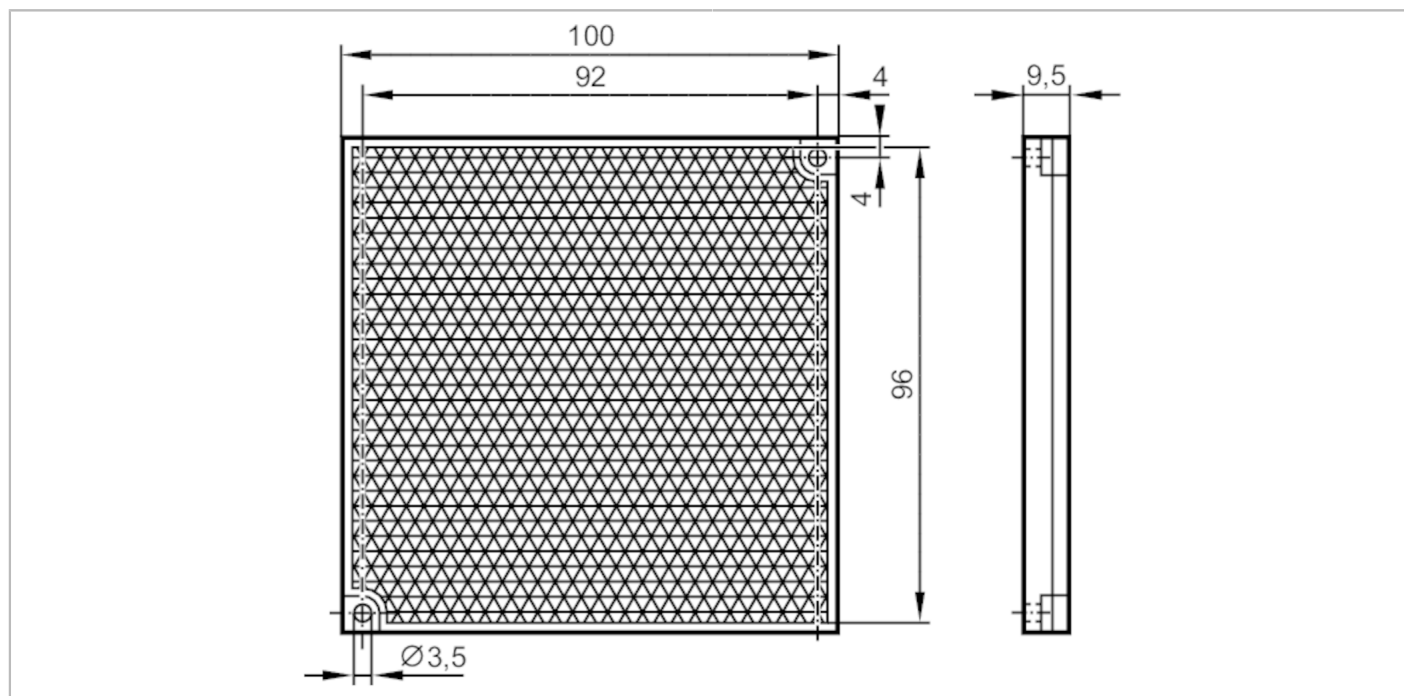

Reflector for retro-reflective sensors

REFLECTOR TS-96x96



Application	
Design	rectangular, for red light and infrared light retro-reflective sensors
Operating conditions	
Ambient temperature [°C]	-10...60
Mechanical data	
Weight [g]	66.6
Dimensions [mm]	100 x 100 x 9.5
Materials	plastics
Remarks	
Pack quantity	1 pcs.