



Part no.: 50127773
FT328I.3/4P-M12P1
Energetic diffuse sensor



Figure can vary

Contents

- Technical data
- Dimensioned drawings
- Electrical connection
- Operation and display
- Part number code
- Notes
- Accessories

Technical data

Basic data	
Series	328
Operating principle	Diffuse reflection principle
Application	Detection of labels on bottles
Optical data	
Operating range	Guaranteed operating range
Operating range, white 90%	0.08 ... 0.1 m
Operating range limit	Typical operating range
Operating range limit, white 90%	0.08 ... 0.12 m
Light source	LED , Infrared
LED light wavelength	850 nm
Transmitted-signal shape	Pulsed
LED group	Exempt group (in acc. with EN 62471)
Electrical data	
Protective circuit	Polarity reversal protection Short circuit protected
Performance data	
Supply voltage U_B	10 ... 30 V , DC , Incl. residual ripple
Outputs	
Number of digital switching outputs	2 Piece(s)
Switching outputs	
Voltage type	DC
Switching voltage	high: $\geq(U_B-2.5V)$ low: $\leq 2.5V$
Switching output 1	
Assignment	Connection 1, pin 4
Switching element	Transistor , PNP
Switching principle	Light switching
Switching output 2	
Assignment	Connection 1, pin 2
Switching element	Transistor , PNP
Switching principle	Dark switching
Timing	
Switching frequency	500 Hz
Response time	1 ms
Readiness delay	300 ms
Connection	

Part no.: 50127773 – FT328I.3/4P-M12P1 – Energetic diffuse sensor
Connection 1

Type of connection	Connector
Function	Signal OUT Voltage supply
Thread size	M12
Type	Male
Material	Plastic
No. of pins	4 -pin
Encoding	A-coded

Mechanical data

Thread size	M18 x 1 mm
Dimension (Ø x L)	18 mm x 46 mm
Housing material	Plastic Stainless steel , V2A , ABS
Lens cover material	Plastic
Net weight	20 g
Housing color	Black Silver

Operation and display

Type of display	LED
Number of LEDs	1 Piece(s)
Operational controls	Teach button

Environmental data

Ambient temperature, operation	-40 ... 60 °C
Ambient temperature, storage	-40 ... 70 °C

Certifications

Degree of protection	IP 67
Protection class	III
Certifications	c UL US
Standards applied	IEC 60947-5-2

Classification

Customs tariff number	85365019
eCl@ss 8.0	27270903
eCl@ss 9.0	27270903
ETIM 5.0	EC001821
ETIM 6.0	EC001821

Dimensioned drawings

All dimensions in millimeters

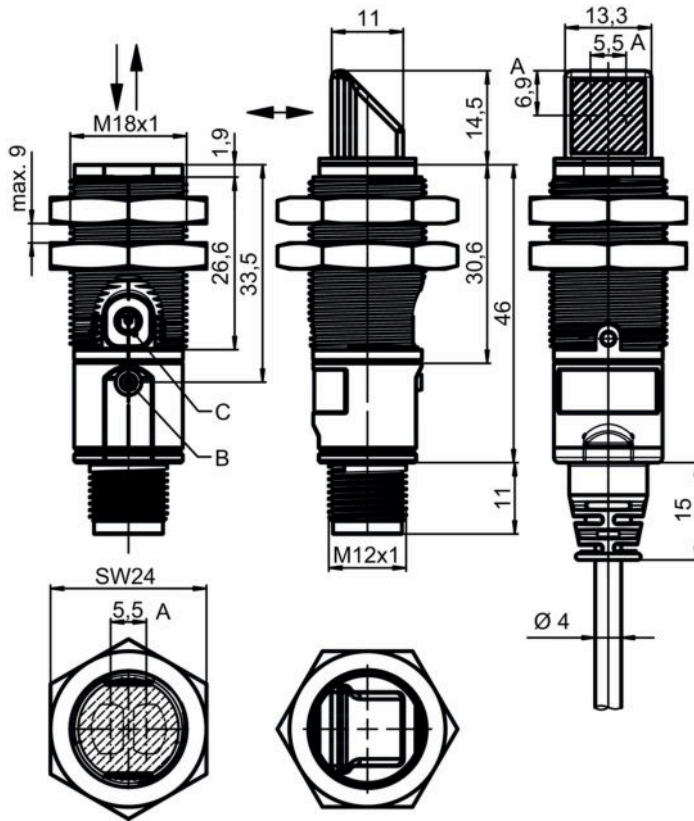

Electrical connection

Connection 1	
Type of connection	Connector
Function	Signal OUT Voltage supply
Thread size	M12
Type	Male
Material	Plastic
No. of pins	4 -pin
Encoding	A-coded

Pin	Pin assignment
1	V+
2	OUT 2
3	GND
4	OUT 1

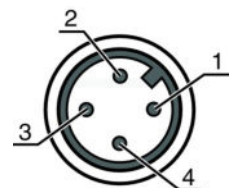

Operation and display

LEDs

LED	Display	Meaning
1	Green, continuous light	Operational readiness
	Yellow, continuous light	Object detected

Part number code

Part designation: XXX328BY-AAAF.BB/CC-DDD

XXX328	Operating principle: PRK: retro-reflective photoelectric sensor with polarization filter ET: energetic diffuse reflection sensor FT: diffuse reflection sensor with fading LE: throughbeam photoelectric sensor receiver LS: throughbeam photoelectric sensor transmitter
Y	Light type: n/a: red light l: infrared light
AAAF	Preset range (optional): n/a: operating range acc. to data sheet XXXX: preset range [mm]
BB	Equipment: n/a: axial optics W: 90° angular optics 3: teach-in via button
CC	Switching output / function (OUT1 = pin 4, OUT2 = pin 2):: 4: PNP transistor output, light switching P: PNP transistor output, dark switching 2: NPN transistor output, light switching N: NPN transistor output, dark switching 9: input for transmitter deactivation (deactivation with HIGH signal) D: input for transmitter deactivation (deactivation with LOW signal) X: pin not used
DDD	Electrical connection: n/a: cable, standard length 2000 mm, 4-wire M12: M12 connector, 4-pin (plug)

Note

A list with all available device types can be found on the Leuze electronic website at www.leuze.com.

Notes

Observe intended use!

- This product is not a safety sensor and is not intended as personnel protection.
- The product may only be put into operation by competent persons.
- Only use the product in accordance with its intended use.

For UL applications:



- For UL applications, use is only permitted in Class 2 circuits in accordance with the NEC (National Electric Code).
- These proximity switches shall be used with UL Listed Cable assemblies rated 30V, 0.5A min, in the field installation, or equivalent (categories: CYJV/CYJV7 or PVVA/PVVA7)

Part no.: 50127773 – FT328I.3/4P-M12P1 – Energetic diffuse sensor

- Sum of the output currents for both outputs, 50 mA for ambient temperatures > 40 °C
- With the set scanning range, a tolerance of the operating range is possible depending on the reflection properties of the material surface.

Accessories

Connection technology - Connection cables

	Part no.	Designation	Article	Description
	50130652	KD U-M12-4A-V1-050	Connection cable	Connection 1: Connector, M12, Axial, Female, A-coded, 4 -pin Connection 2: Open end Shielded: No Cable length: 5,000 mm Sheathing material: PVC
	50130690	KD U-M12-4W-V1-050	Connection cable	Connection 1: Connector, M12, Angled, Female, A-coded, 4 -pin Connection 2: Open end Shielded: No Cable length: 5,000 mm Sheathing material: PVC

Mounting technology - Mounting brackets

	Part no.	Designation	Article	Description
	50113548	BT D18M.5	Mounting bracket	Diameter, inner: 18 mm Design of mounting device: Angle, L-shape Fastening, at system: Through-hole mounting Mounting bracket, at device: Screw type Type of mounting device: Rigid Material: Stainless steel

Mounting technology - Rod mounts

	Part no.	Designation	Article	Description
	50117490	BTU D18M-D12	Mounting system	Design of mounting device: Mounting system Fastening, at system: Through-hole mounting Mounting bracket, at device: Screw type Type of mounting device: Clampable, Adjustable, Turning, 360° Material: Metal

Mounting technology - Other

	Part no.	Designation	Article	Description
	50126631	BT 328M	Fastening	Contains: 2x M18 mounting nut Design of mounting device: Mounting clamp Fastening, at system: For 18 mm rod, Through-hole mounting Mounting bracket, at device: Screw type Type of mounting device: Turning, 360° Material: Stainless steel

Part no.: 50127773 – FT328I.3/4P-M12P1 – Energetic diffuse sensor

Note

A list with all available accessories can be found on the Leuze electronic website in the Download tab of the article detailed page.