



Figure can vary

**Part no.: 50141795**  
**DCR 202i FIX-N1-102-I3-G**  
**Stationary 2D-code reader**



**RS232**

**RS422**

Ethernet

## Contents

- . Technical data
- . Dimensioned drawings
- . Electrical connection
- . Diagrams
- . Operation and display
- . Part number code
- . Notes
- . Accessories

## Technical data

<b>Basic data</b>	
Series	DCR 200i
Chip	CMOS
<b>Functions</b>	
Software functions	Reading of 1D codes Reading of 2D codes
<b>Read data</b>	
Code types, readable	2/5 Interleaved Aztec Codabar Code 128 Code 32 Code 39 Code 93 Data Matrix Code EAN 128 EAN 8/13 GS1 Databar GS1 Databar Omnidirectional GS1 Databar QR code GS1 Databar Stacked PDF417 Pharma Code QR code UPC
<b>Optical data</b>	
Reading distance	40 ... 120 mm
Light source	LED , Infrared
Transmitted-signal shape	Pulsed
Camera resolution, horizontal	1,280 px
Camera resolution, vertical	960 px
Modulus size	0.127 ... 0.5 mm
Electronic shutter speed	0.068 ... 5 ms
Camera type	Monochrome
<b>Electrical data</b>	
Protective circuit	Polarity reversal protection Short circuit protected
<b>Performance data</b>	
Supply voltage $U_B$	18 ... 30 V , DC
Average power consumption	8 W
<b>Inputs</b>	
Number of digital switching inputs	1 Piece(s)
<b>Switching inputs</b>	
Voltage type	DC

<b>Outputs</b>	
Number of digital switching outputs	1 Piece(s)
<b>Switching outputs</b>	
Voltage type	DC
Switching current, max.	100 mA
<b>Switching output 1</b>	
Switching element	MOSFET semiconductor ,
Switching principle	+24 V switching
<b>Inputs/outputs selectable</b>	
Number of inputs/outputs selectable	2 Piece(s)
Voltage type, outputs	DC
Voltage type, inputs	DC

<b>Interface</b>	
Type	RS 232 , RS 422 , Ethernet
<b>RS 232</b>	
Function	Process
Transmission speed	4,800 ... 115,200 Bd
Data format	Adjustable
Start bit	1
Data bit	8 data bits
Stop bit	1 stop bit
Parity	None
Transmission protocol	<STX><data><CR><LF>
Data encoding	ASCII Binary
<b>RS 422</b>	
Function	Process
Transmission speed	4,800 ... 115,200 Bd
Data format	Adjustable
Start bit	1
Data bit	7, 8 data bits
Stop bit	1, 2 stop bits
Data encoding	ASCII Binary
<b>Ethernet</b>	
Architecture	Client Server
Address assignment	DHCP Manual address assignment
Transmission speed	10 Mbit/s 100 Mbit/s
Function	Process
Switch functionality	None
Transmission protocol	TCP/IP , UDP

<b>Service interface</b>	
Type	Ethernet
<b>Ethernet</b>	
Function	Service

**Connection**

Number of connections 2 Piece(s)

**Connection 1**

 Function Data interface  
Signal IN  
Signal OUT  
Voltage supply

Type of connection Connector

Thread size M12

Type Male

Material Metal

No. of pins 12 -pin

Encoding A-coded

**Connection 2**

 Function Configuration interface  
Data interface

Type of connection Connector

Thread size M12

Type Female

Material Metal

No. of pins 4 -pin

Encoding D-coded

**Mechanical data**

Design Cubic

Dimension (W x H x L) 43 mm x 61 mm x 44 mm

 Housing material Metal  
Plastic , Diecast aluminum , PC

Lens cover material Glass

Net weight 120 g

Housing color Silver

 Type of fastening Mounting thread  
Via optional mounting device

**Operation and display**

Type of display LED

Number of LEDs 10 Piece(s)

 Type of configuration Configuration codes  
Teach-in  
Via web browser

Operational controls Button(s)

 Function of the operational control Adjustment mode  
Auto-setup  
Trigger

**Environmental data**

Ambient temperature, operation 0 ... 50 °C

Ambient temperature, storage -20 ... 70 °C

Relative humidity (non-condensing) 90 %

**Certifications**

Degree of protection IP 65

Protection class III

Certifications	c UL US
Test procedure for EMC in accordance with standard	EN 61000-6-2 EN 61000-6-4
Test procedure for continuous shock in accordance with standard	IEC 60068-2-29, test Eb
Test procedure for vibration in accordance with standard	IEC 60068-2-6, test Fc

#### Classification

Customs tariff number	84719000
eCl@ss 8.0	27280103
eCl@ss 9.0	27280103
ETIM 5.0	EC002999
ETIM 6.0	EC002999

## Dimensioned drawings

All dimensions in millimeters

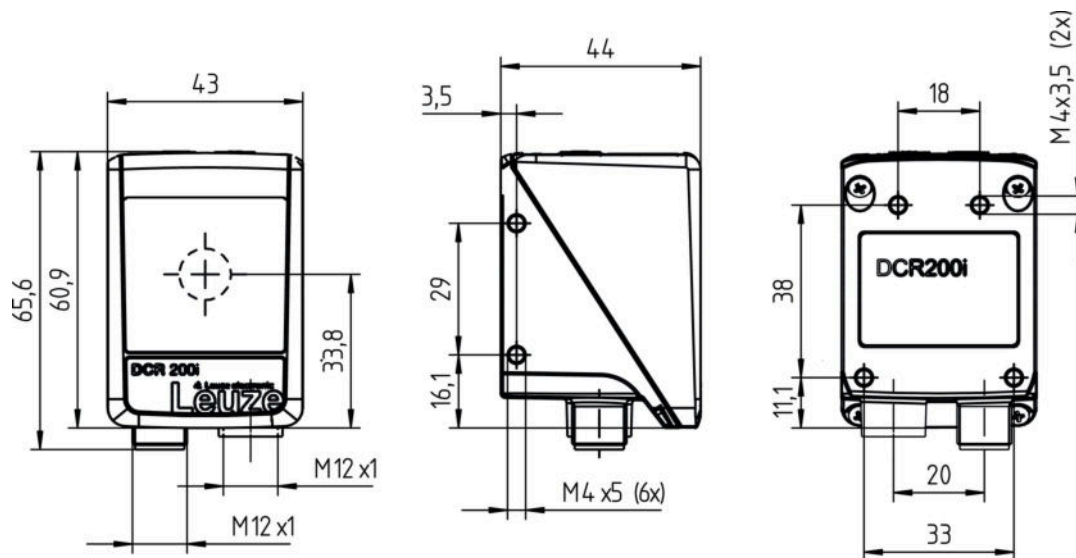

## Electrical connection

Connection 1	PWR / SWIO
Function	Data interface Signal IN Signal OUT Voltage supply
Type of connection	Connector
Thread size	M12
Type	Male
Material	Metal
No. of pins	12 -pin
Encoding	A-coded

Pin	Pin assignment
1	VIN
2	GNDIN
3	SWIN 1
4	SWOUT 2
5	FE
6	GND RS 232 / GND RS 422
7	Rx-
8	Tx-
9	RxD/Rx+
10	TxD/Tx+
11	SWIO 3
12	SWIO 4

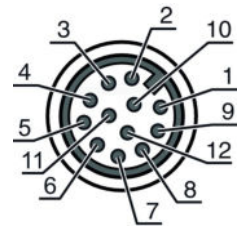

Connection 2	HOST
Function	Configuration interface Data interface
Type of connection	Connector
Thread size	M12
Type	Female
Material	Metal
No. of pins	4 -pin
Encoding	D-coded

Pin	Pin assignment
1	TD+
2	RD+
3	TD-
4	RD-

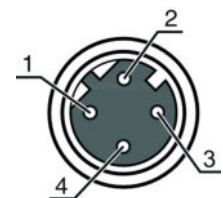

## Diagrams

### Reading distances

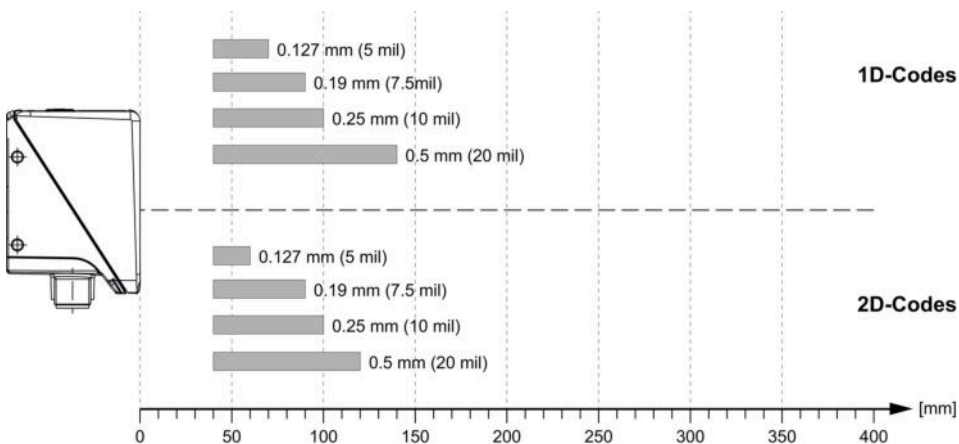

Relationship between camera distance and reading field size

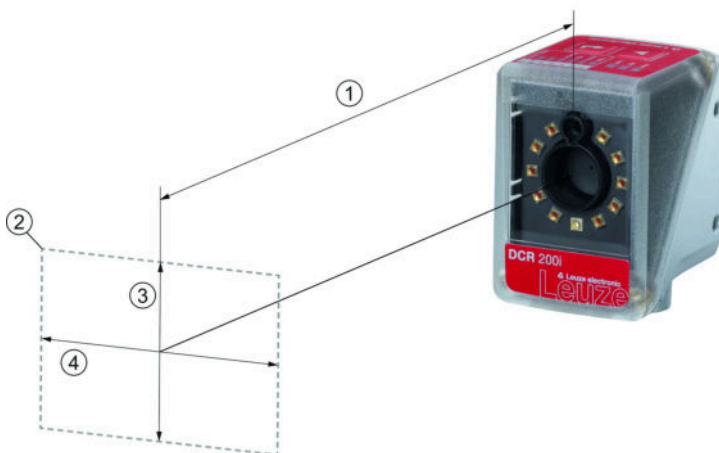

- 1 Camera distance
- 2 Reading field
- 3 Reading field height [mm]
- 4 Reading field width [mm]

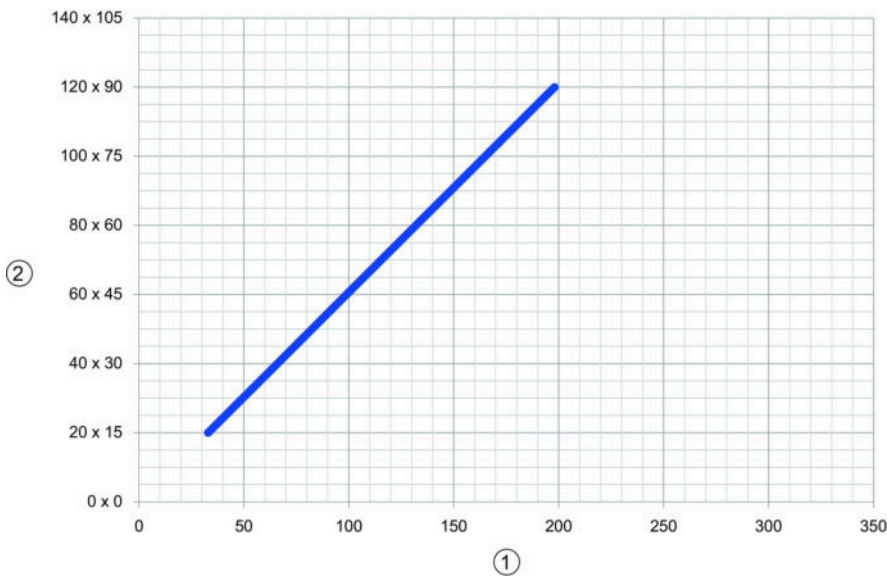

- 1 Camera distance [mm]
- 2 Reading field: width x height [mm]

**Operation and display**

**LEDs**

LED	Display	Meaning
1   PWR	Off	No supply voltage
	Green, flashing	Initialization
	Green, continuous light	Operational readiness

LED	Display	Meaning	
	Orange, continuous light	Service operation	
	Red, flashing	Device OK, warning set	
	Red, continuous light	Device error	
2	NET	Off	No supply voltage
		Green, flashing	Initialization
		Green, continuous light	Operational readiness
		Red, flashing	Communication error
		Red, continuous light	Network error
3	LINK	Green, continuous light	Ethernet connection is established
		Yellow, flashing	Data exchange active
4	TRIG	Green, flashing	Trigger and display of the read quality
5	AUTO	Green, flashing	Auto-setup and display of the read quality
6	ADJ	Green, flashing	Alignment mode and display of the read quality
7	TEACH	Green, flashing	Teach-in and display of the read quality

## Part number code

Part designation: DCR XXX YYY-Z-AAA-BC-D-EEEE

DCR	<b>Operating principle:</b> DCR: Dual Code Reader
XXXX	<b>Series/interface (integrated fieldbus technology):</b> 202i: Ethernet TCP/IP, UDP, RS 232/RS 422 248i: PROFINET-IO, Ethernet TCP/IP, UDP, RS 232/RS 422
YYY	<b>Equipment:</b> FIX: Fixed focal length
Z	<b>Optics:</b> U: Ultra high density (very close) N: High Density (close) M: Medium Density (medium distance) F: Low Density (remote) L: Ultra low density (very large distance)
AAA	<b>Beam exit:</b> 102: front
B	<b>Illumination:</b> R: Red light I: infrared light
C	<b>Resolution range:</b> 3: 1280 x 960 pixels
D	<b>Protective screen:</b> n/a: plastic G: Glass P: Polarization filter
EEEE	<b>Special equipment:</b> V: Stainless steel housing F001: NPN inputs/outputs H: with heating

### Note

A list with all available device types can be found on the Leuze website at [www.leuze.com](http://www.leuze.com).





## Notes

### Observe intended use!

- This product is not a safety sensor and is not intended as personnel protection.
- The product may only be put into operation by competent persons.
- Only use the product in accordance with its intended use.

## Accessories

### Connection technology - Connection cables

	Part no.	Designation	Article	Description
	50130281	KD S-M12-CA-P1-020	Connection cable	Connection 1: Connector, M12, Axial, Female, A-coded, 12 -pin Connection 2: Open end Shielded: Yes Cable length: 2,000 mm Sheathing material: PUR
	50135073	KS ET-M12-4A-P7-020	Connection cable	Suitable for interface: Ethernet Connection 1: Connector, M12, Axial, Male, D-coded, 4 -pin Connection 2: Open end Shielded: Yes Cable length: 2,000 mm Sheathing material: PUR

### Connection technology - Interconnection cables

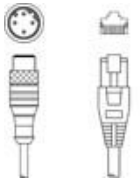
	Part no.	Designation	Article	Description
	50135080	KSS ET-M12-4A-RJ45-A-P7-020	Interconnection cable	Suitable for interface: Ethernet Connection 1: Connector, M12, Axial, Male, D-coded, 4 -pin Connection 2: RJ45 Shielded: Yes Cable length: 2,000 mm Sheathing material: PUR

### Mounting technology - Mounting brackets

	Part no.	Designation	Article	Description
	50132151	BT 320M	Mounting bracket	Design of mounting device: Angle, L-shape Fastening, at system: Through-hole mounting Mounting bracket, at device: Screw type Type of mounting device: Rigid Material: Metal

Part no.: 50141795 – DCR 202i FIX-N1-102-I3-G – Stationary 2D-code reader



## Mounting technology - Rod mounts

	Part no.	Designation	Article	Description
	50132150	BTU 320M-D12	Mounting system	Design of mounting device: Mounting system Fastening, at system: For 12 mm rod Mounting bracket, at device: Screw type Type of mounting device: Clampable, Adjustable, Turning, 360° Material: Metal

## General

	Part no.	Designation	Article	Description
	50144030	IL AL 034/031 IR 110 H	Illumination	

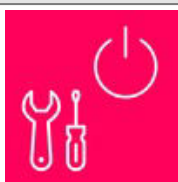
## Services

	Part no.	Designation	Article	Description
	S981014	CS30-S-110	Start-up support	Details: Performed at location of customer's choosing, duration: max. 10 hours. Conditions: Devices and connection cables are already mounted, price not including travel costs and, if applicable, accommodation expenses. Restrictions: No mechanical (mounting) and electrical (wiring) work performed, no changes (attachments, wiring, programming) to third-party components in the nearby environment.
	S981019	CS30-T-110	Product training	Details: Location and content to be agreed upon, duration: max. 10 hours. Conditions: Price not including travel costs and, if applicable, accommodation expenses. Restrictions: Travel costs and accommodation expenses charged separately and according to expenditure.

### Note

A list with all available accessories can be found on the Leuze electronic website in the Download tab of the article detailed page.