

M12 MALE 0° / MSUD VALVE PLUG FORM A 18MM

PUR 5X0.34 GRAY, 1.8m

Form A (18 mm) – M12, male straight
for pressure switches
LED (yellow/green)
5-pole

Further cable lengths on request. Plastic housings with good resistance against chemicals and oils. The resistance to aggressive media should be individually tested for your application. Further details on request.

[Link to Product](#)

Illustration

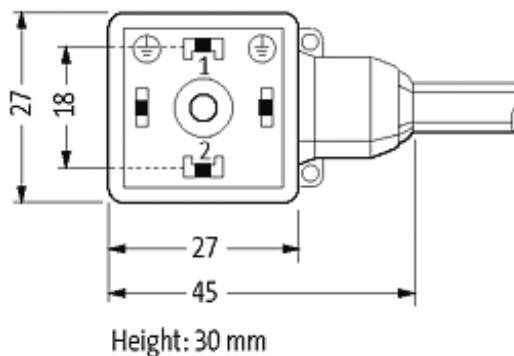
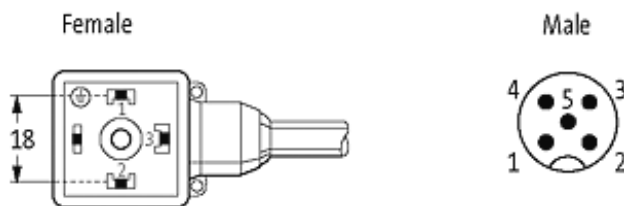
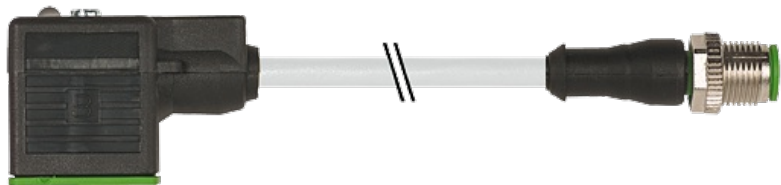



Product may differ from Image

Approvals



Form

40931

Technical Data

Operating voltage	24 V DC $\pm 25\%$
Operating current per contact	max. 4 A
Locking of ports	M3/M12 \times 1 mm (recommended torque 0.4/0.6 Nm)
Protection	IP67 inserted and tightened (EN 60529)
Housing	Black plastic (gray on request)

Cables

Cable number	225
No./diameter of wires	5 \times 0.34 mm ²
Wire isolation	PVC (br, wh, bl, bk, gnye)
C-track properties	2 Mio.
Jacket Color	gray
Shore hardness outer jacket	85 \pm 5A
Material (jacket)	PUR/PVC (UL/CSA)
Outer diameter	approx. 5.9 mm
Bend radius (fixed)	10 \times outer \varnothing
Bend radius (moving)	15 \times outer \varnothing
Temperature range (fixed)	-30...+80 °C
Temperature range (mobile)	-5...+80 °C

Commercial data

country of origin	CZ
customs tariff number	85444290
minimum order quantity	1