

- > Anschluss: Ø 4 ... 16 mm Rohr aussen
- > Pneufit® C ermöglicht eine blitzschnelle Montage und Demontage sowie optimalen Durchfluss.
- > Pneufit® C bietet eine große Auswahl an über 1.000 pneumatischen Push-In Verschraubungen zur weiteren Ergänzung unserer bewährten Pneufit® Messingserie.
- > Lösbarer, aus rostfreiem Stahl hergestellter Greifring für den sicheren Halt von PA- oder PUR-Schläuchen (85 oder 95 Shore-A)

- > Vernickelte Messingkomponenten sind widerstandsfähig gegenüber Korrosion sowie Verschmutzung und erhöhen somit die Nutzungsdauer.
- > Dichtvorbeschichtung auf allen konischen Gewinden sowie ein unverlierbarer gekammerter O-Ring bei allen zylindrischen Gewinden gewährleistet eine optimale Abdichtung.



Technische Merkmale

Betriebsmedium:

Druckluft

Betriebsdruck:

10 bar (145 psi) max.

Vakuum:

750 mm Hg

Gewindegrößen:

M5, M6, 1/8, 1/4, 3/8 und 1/2 ISO G, ISO Rc und ISO R

Umgebungs-/Mediums-temperatur:

-20°C ... +60°C (-4 ... 140°F)

Rohr-/ Schlauchgrößen:

4, 6, 8, 10, 12 und 16 mm

Schläuche:

PA 11 oder 12
 PUR 85, 95 oder 98 Shore

Achtung:

Die hier beschriebenen Push-In-Schnellsteckverbinder dürfen nicht in Druckluftbrems- oder hilfssystemen von Fahrzeugen eingesetzt werden. Schnellsteckverbindungen, die für diese Anwendungsbereiche geeignet sind, finden Sie unter den Fleetfit-Verbindungen.

Materials:

Grundkörper: PBT
 Dichtungen & O-Ringe: NBR (VMQ-frei)
 Gewindekörper: Messing vernickelt
 Löse- und Rückhaltering: POM
 Greifring: rostfreier Stahl
 Kragenhülse: Messing vernickelt
 Gewindebeschichtung: chemitech G-175L

Montagehinweise



1. Rohrenden rechtwinklig abschneiden und innen sowie außen entgraten

2. Rohrende (Außenoberfläche frei von Beschädigungen) durch den Lösering schieben]

3. Leichten Widerstand vom O-Ring überwinden und bis zum Anschlag eindrücken.

4. Lösering gegen die Armatur drücken und Rohr herausziehen

Einzelteile

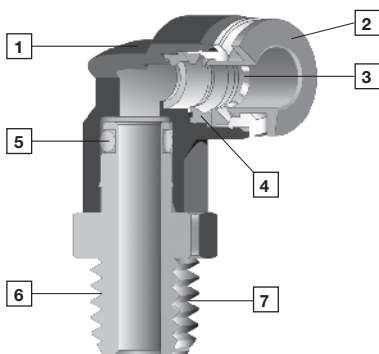

- 1 Schlagfester PBT Körper in schwarz
- 2 Lösering: rot für metrische Ausführung
- 3 Greifring aus rostfreiem Stahl in speziellem Design ermöglicht und einfache Demontage des Schlauches.
- 4 Silikonfreier Dichtring bietet optimale Schlauchabdichtung.
- 5 O-Ring am Stößel sichert optimale Abdichtung des 360° Drehkörpers.
- 6 Vernickelte Messinggewinde. Kerbe auf Sechskant kennzeichnet NPT-Gewinde
- 7 Dichtvorbeschichtung auf allen konischen Gewinden sowie gekammerter O-Ring bei allen zylinderischen Gewinden.

Typenschlüssel



Gerade Verbindungen und gerade Ein-, Aufschraubverbindungen

<p>Gerade Einschraubverschraubung (Außen- und Innensechskant) C0125</p>  <p>Seite 7</p>	<p>Gerade Einschraubverschraubung (Außen- und Innensechskant) C0225</p>  <p>Seite 7</p>	<p>Gerade Einschraubverschraubung (Innensechskant) C012A/C022A</p>  <p>Seite 7</p>	<p>Gerade Aufschraubverschraubung, zylindrisches Gewinde C0226</p>  <p>Seite 7</p>	<p>Gerade Durchgangsverbindung C0020</p>  <p>Seite 8</p>	<p>Gerade Reduzierverbindung C0020</p>  <p>Seite 8</p>	<p>Gerade Reduzier-Steckverbindung C0023</p>  <p>Seite 8</p>
<p>Gerade Reduzier-Steckverbindung C0023</p>  <p>Seite 8</p>	<p>Gerade Schottverbindung C0029</p>  <p>Seite 8</p>	<p>Gerade Aufschraub-Schottverschraubung (Innengewinde) C0232</p>  <p>Seite 8</p>	<p>Doppelstecknippel C0022</p>  <p>Seite 8</p>	<p>Reduzierstecknippel C0022</p>  <p>Seite 9</p>	<p>Stopfen C0004</p>  <p>Seite 9</p>	<p>Verschlusskupplung C0012</p>  <p>Seite 9</p>

Winkelverbindungen und drehbare Winkel-, Ein- und Aufschraubverschraubungen

<p>Winkelverbindung C0040</p>  <p>Seite 9</p>	<p>90° Drehbare Winkel-Einschraubverschraubung kegeliges Gewinde C0147</p>  <p>Seite 9</p>	<p>90° Drehbare Winkel-Einschraubverschraubung zylindrisches Gewinde C0247</p>  <p>Seite 9</p>	<p>Winkel-Steckverbindung C0043</p>  <p>Seite 10</p>	<p>90° Drehbare Winkel-Einschraubverschraubung lang C0154/C0254</p>  <p>Seite 10</p>	<p>90° Drehbare Winkel-Aufschraubverschraubung C0148/C0248</p>  <p>Seite 10</p>	<p>Winkel-Schottverbindung C0049</p>  <p>Seite 10</p>
--	--	--	--	---	---	---

Y-Verbindungen und Mehrfachverteiler 4-fach

<p>Y-Verbindung Y-Reduzierverbindung C0082</p>  <p>Seite 11</p>	<p>Drehbare Y-Einschraubverschraubung, kegeliges Gewinde C0188</p>  <p>Seite 11</p>	<p>Drehbare Y-Einschraubverschraubung, zyl. Gewinde C0288</p>  <p>Seite 11</p>	<p>Y-Steckverbindung Y-Reduziersteckverbindung C0084</p>  <p>Seite 11</p>	<p>Mehrfachverteiler 4-fach C0096</p>  <p>Seite 12</p>	<p>Mehrfachverteiler 4-fach, kegeliges Gewinde C0195</p>  <p>Seite 12</p>	<p>Mehrfachverteiler 4-fach, zylindrisches Gewinde C0295</p>  <p>Seite 12</p>	<p>Mehrfach-Steckverteiler 4-fach C0097</p>  <p>Seite 12</p>
---	--	---	--	---	---	--	---

























T-Verbindungen und drehbare T- Einschraubverschraubung

<p>T-Verbindung C0060</p>  <p>Seite 12</p>	<p>T-Reduzierverbindung C006A</p>  <p>Seite 12</p>	<p>Drehbare T-Einschraubverschraubung, kegeliges Gewinde C0167</p>  <p>Seite 13</p>	<p>Drehbare T-Einschraubverschraubung, zylindrisches Gewinde C0267</p>  <p>Seite 13</p>	<p>Drehbare T-Einschraubverschraubung, seitlich C016C/C026C</p>  <p>Seite 13</p>	<p>T-Steckverbindung C0063</p>  <p>Seite 13</p>
<p>T-Reduziersteckverbindung C0063</p>  <p>Seite 13</p>	<p>T-Steckverbindung seitlich C0064</p>  <p>Seite 14</p>	<p>T-Reduziersteckverbindung seitlich C0064</p>  <p>Seite 14</p>	<p>Drehbare T-Einschraubverschraubung, seitlich kegeliges Gewinde C0168</p>  <p>Seite 14</p>	<p>Drehbare T-Einschraubverschraubung, seitlich zyl. Gewinde</p>  <p>Seite 14</p>	

Winkel-Schwenkverschraubung mit Drosselrückschlagventil

Drosselrückschlagventil (Abluft), kegeliges Gewinde C0TA0  Seite 20	Drosselrückschlagventil (Abluft), zylindrisches Gewinde C0K51  Seite 20	Drosselrückschlagventil (Zuluft), kegeliges Gewinde COSA0  Seite 21	Drosselrückschlagventil (Zuluft), zylindrisches Gewinde COL51  Seite 21	Drosselrückschlagventil (Abluft), kegeliges Gewinde COTBO  Seite 21	Drosselrückschlagventil (Abluft), zylindrisches Gewinde COKBO  Seite 21
Drosselrückschlagventil (Abluft), kegeliges Gewinde COT56  Seite 22	Drosselrückschlagventil (Abluft), zylindrisches Gewinde COK56  Seite 22	Drosselrückschlag mit Stoppventil, kegeliges Gewinde CO1GN  Seite 23	Drosselrückschlag-mit Stoppventil, zylindrisches Gewinde CO2GN  Seite 23	Drosselrückschlagventil COOGE  Seite 24	Drosselrückschlagventil C00GP  Seite 24

Kreuz- und Mehrfachverteiler

Kreuzverbindung C0090  Seite 14	Mehrfachverteiler, 4-fach C00D3  Seite 15	Mehrfach-Einschraubverteiler, 4-fach, kegeliges Gewinde C01D3  Seite 15	Mehrfach-Steckverteiler C00J3  Seite 15		
Schwenkverschraubung, zylindrisches Gewinde C0A51  Seite 15	Schwenkverschraubung COD51, COE51, COF51, COG51  Seite 15	Schwenkverschraubung 2-fach, kegeliges Gewinde C0Q51  Seite 16	Schwenkverschraubung 2-fach, zylindrisches Gewinde C0B51  Seite 16	Schwenkverschraubung 3-fach, kegeliges Gewinde COH51  Seite 16	Schwenkverschraubung 3-fach, zylindrisches Gewinde C0C51  Seite 16
T-Schwenkverschraubung kegeliges Gewinde C0N71  Seite 17	T-Schwenkverschraubung zylindrisches Gewinde C0A71  Seite 17	T-Schwenkverschraubung 2-fach, kegeliges Gewinde COQ71  Seite 17	T-Schwenkverschraubung 2-fach, zylindrisches Gewinde C0B71  Seite 17	T-Schwenkverschraubung 3-fach, kegeliges Gewinde C0H71  Seite 18	T-Schwenkverschraubung 3-fach, zylindrisches Gewinde C0C71  Seite 18
Schwenkverschraubung CON70  Seite 18	Schwenkverschraubung COA70  Seite 18	Durchgangs-Schwenkverschraubung, kegeliges Gewinde C0*7K  Seite 19	Durchgangs-Schwenkverschraubung, zyl. Gewinde C0*7J  Seite 19	Durchgangs-Schwenkverschraubung, 4-fach kegeliges Gewinde C0Q70  Seite 19	Durchgangs-Schwenkverschraubung, 4-fach zyl. Gewinde C0B70  Seite 19
Durchgangs-Schwenkverschraubung, 6-fach kegeliges Gewinde COH70  Seite 20	Durchgangs-Schwenkverschraubung, 6-fach zyl. Gewinde C0C70  Seite 20				

Rückschlagventil

Rückschlagventil
 C00GL



Seite 25

Rückschlagventil
 (Zuluft), kegeliges
 Gewinde
 C01G2



Seite 25

Rückschlagventil
 (Zuluft), zylindrisches
 Gewinde
 C02G2



Seite 25

Rückschlagventil
 (Abluft), kegeliges
 Gewinde
 C01G3



Seite 25

Rückschlagventil
 (Abluft), zylindrisches
 Gewinde
 C02G3



Seite 25

Absperrbare Verbindungen

Gerade Verschraubung
 absperrend, kegeliges
 Gewinde
 C0124



Seite 26

Gerade Verschraubung
 absperrend, zylindri-
 sches Gewinde
 C0224



Seite 26

Gerade Verbindung
 absperrend
 C002J



Seite 26

Winklerschraubung
 absperrend, kegeliges
 Gewinde
 C014J



Seite 26

Winklerschraubung
 absperrend, zylindri-
 sches Gewinde
 C024J



Seite 26

Absperrventile mit Entlüftung

3/2 Absperrventil,
 kegeliges Gewinde
 C01GG



Seite 27

3/2 Absperrventil,
 kegeliges Gewinde
 C01GH



Seite 27

3/2 Absperrventil,
 kegeliges Gewinde
 C01GJ



Seite 27

3/2 Absperrventil
 C01GF



Seite 27

Durchfluss Diagramm für C0K51, C0TA0, COL51, C0K56, C0T56 und C0SA0

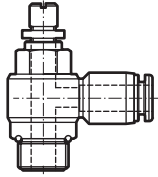

**3, 4 und 6 mm
M5**

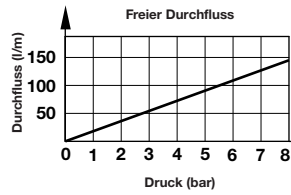
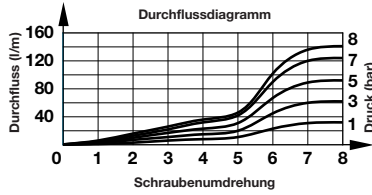

Durchfluss Diagramm für C00GE

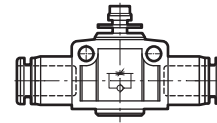

C00G*0400

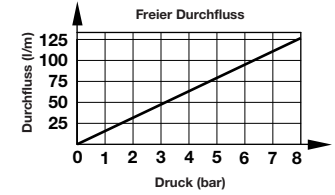
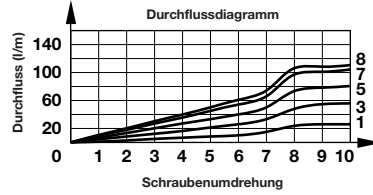

**4, 6 und 8 mm
1/8**

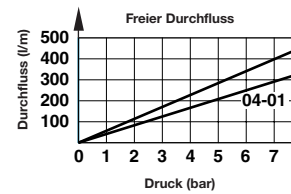
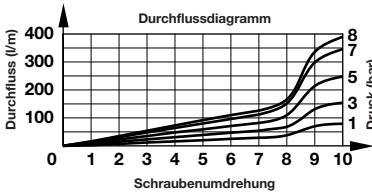

C00G*0600

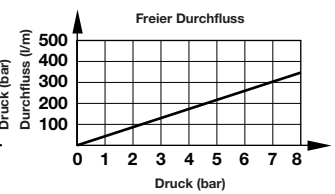
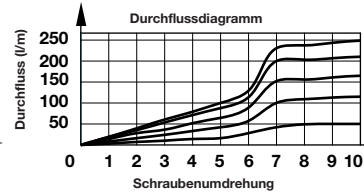

**4, 6, 8, 10 und 12 mm
1/4**

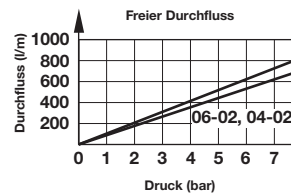
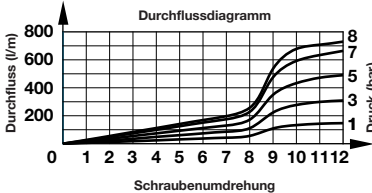

C00G*0800

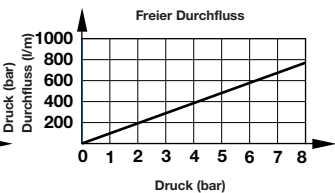
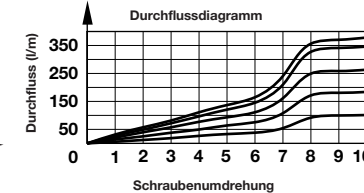

**6, 8, 10 und 12 mm
3/8**

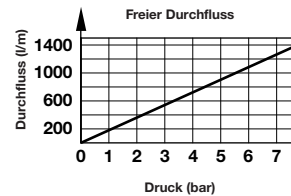
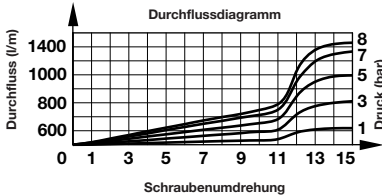

C00G*1000

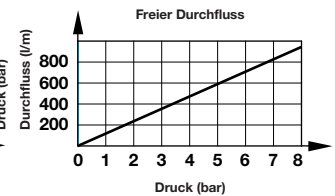
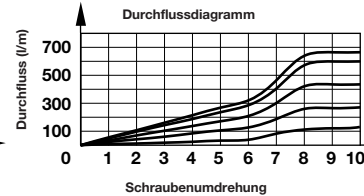

8, 10 und 12 mm 1/2

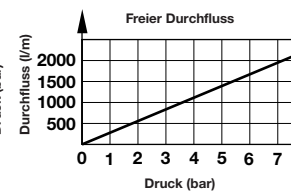
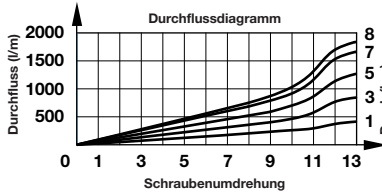

C00G*1200

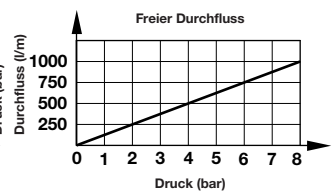
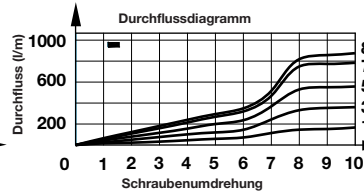

Durchfluss Diagramm für C01GN und C02GN

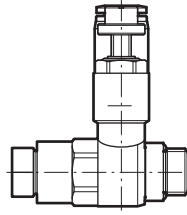

6 und 8 mm
 1/8

8, 10 und 12 mm
 3/8

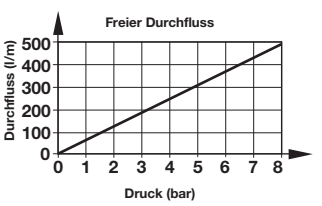
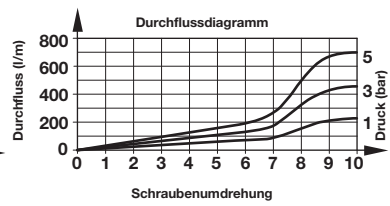
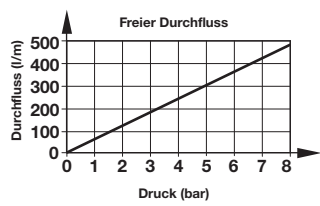
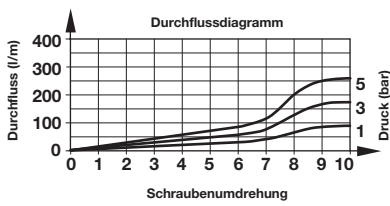

6 und 8 mm
 1/4

10 und 12 mm
 1/2

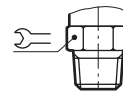
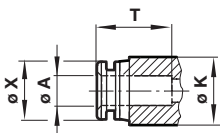
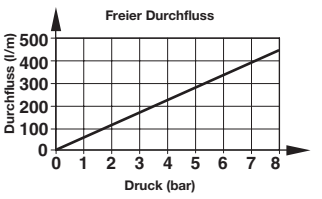
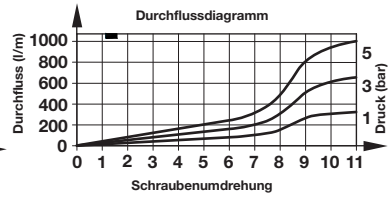
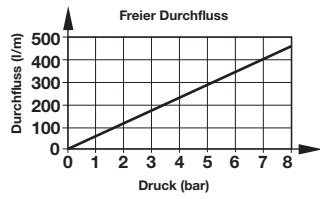
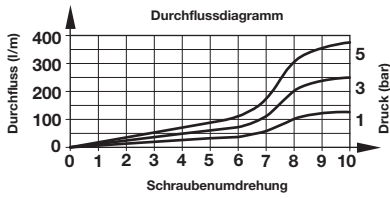

Technische Daten

Ø A	Ø K	T*1)	Ø X
4	10,5	15	9,5
6	12,5	16,5	12
8	14,5	18,5	14
10	17,5	20	16,5
12	20,5	23	19
16	27	23,5	25

Gewinde	Empfohlenes Anzugsmoment	Gewinde	Empfohlenes Anzugsmoment
M5	1,5 Nm		
M6	2,3 Nm		
G1/8	10 Nm	R1/8	7 Nm
G1/4	15 Nm	R1/4	12 Nm
G3/8	25 Nm	R3/8	22 Nm
G1/2	40 Nm	R1/2	28 Nm

*1) Abmessungen mit eingeschobenem Lösering

**Gerade Einschraubverschraubung
(Außen- und Innensechskant) C0125**

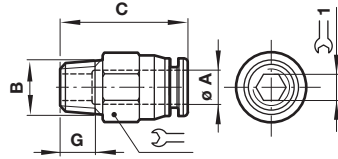

Ø A	B	C	G			Typ
4	R1/8	21,5	8	10	3	C01250418
4	R1/4	20,5	10	14	3	C01250428
4	R3/8	22	11	17	3	C01250438
6	R1/8	22	8	12	4	C01250618
6	R1/4	21	10	14	5	C01250628
6	R3/8	22	11	17	5	C01250638
6	R1/2	29,5	14	19	5	C01250648
8	R1/8	27,5	8	14	5	C01250818
8	R1/4	25,5	10	14	6	C01250828
8	R3/8	23	11	17	6	C01250838
8	R1/2	29,5	14	19	6	C01250848
10	R1/8	28,5	8	17	5	C01251018
10	R1/4	30,5	10	17	6	C01251028
10	R3/8	24,5	11	17	8	C01251038
10	R1/2	29,5	14	19	8	C01251048
12	R1/8	31,5	8	19	5	C01251218
12	R1/4	33	10	19	6	C01251228
12	R3/8	30	11	19	8	C01251238
12	R1/2	30	14	19	8	C01251248
16	R3/8	37,5	11	24	10	C01251638
16	R1/2	40,5	14	24	10	C01251648

**Gerade Aufschraubverschraubung,
zylindrisches Gewinde
C0226**

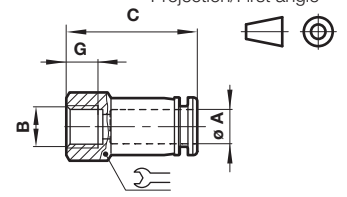

Ø A	B	C	G		Typ
4	M5	26	7	12	C02260405
4	G1/8	26,5	9	14	C02260418
4	G1/4	28,5	11	17	C02260428
4	G3/8	30	12	22	C02260438
6	G1/8	27,5	9	14	C02260618
6	G1/4	29,5	11	17	C02260628
6	G3/8	30	12	22	C02260638
8	G1/8	28,5	9	14	C02260818
8	G1/4	30,5	11	17	C02260828
8	G3/8	31,5	12	22	C02260838
8	G1/2	34,5	14	24	C02260848
10	G1/8	31,5	9	17	C02261018
10	G1/4	31,5	11	17	C02261028
10	G3/8	32,5	12	22	C02261038
10	G1/2	34,5	14	24	C02261048
12	G1/4	34,5	11	22	C02261228
12	G3/8	34,5	12	22	C02261238
12	G1/2	36,5	14	24	C02261248

**Gerade Einschraubverschraubung
(Außen- und Innensechskant)
C0225**

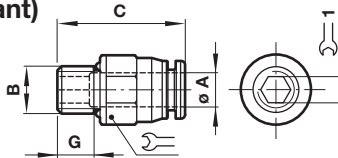

Ø A	B	C	G			Typ
4	M5	22	4	10	-	C02250405
4	M6	22	8	10	-	C02250406
4	G1/8	21,5	6	13	3	C02250418
4	G1/4	23,5	8	15	3	C02250428
4	G3/8	22	8	17	3	C02250438
6	M5	23,5	5	12	-	C02250605
6	M6	23	4	12	-	C02250606
6	G1/8	26,5	6	13	4	C02250618
6	G1/4	24,5	8	15	5	C02250628
6	G3/8	25,5	8	17	5	C02250638
8	G1/8	26,5	6	15	5	C02250818
8	G1/4	26,5	8	15	6	C02250828
8	G3/8	25	8	17	6	C02250838
8	G1/2	26	9	21	6	C02250848
10	G1/8	29,5	6	17	5	C02251018
10	G1/4	30	8	17	8	C02251028
10	G3/8	27	8	17	8	C02251038
10	G1/2	28,5	9	21	8	C02251048
12	G1/4	32	8	19	8	C02251228
12	G3/8	31,5	8	19	8	C02251238
12	G1/2	31,5	9	21	8	C02251248
16	G3/8	36,5	8	24	8	C02251638
16	G1/2	36,5	9	24	10	C02251648

**Gerade Einschraubverschraubung
(Innensechskant) C012A, C022A**

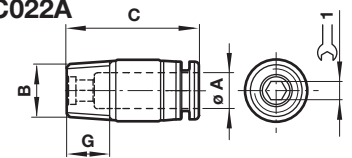

Ø A	B	C	G			Typ
4	M5	22	4,5	2		C022A0405
4	M6	22	4	3		C022A0406
4	R1/8	20,5	8	3		C012A0418
4	R1/4	20,5	10	3		C012A0428
4	R3/8	20,5	11	3		C012A0438
6	M5	22,5	5	2		C022A0605
6	M6	22,5	4	3		C022A0606
6	R1/8	22	8	4		C012A0618
6	R1/4	22,5	10	4		C012A0628
6	R3/8	22,5	11	4		C012A0638
8	R1/8	27	8	5		C012A0818
8	R1/4	25	10	6		C012A0828
8	R3/8	25	11	6		C012A0838
8	R1/2	25	14	6		C012A0848
10	R1/8	28	8	5		C012A1018
10	R1/4	29	10	6		C012A1028
10	R3/8	29	11	8		C012A1038
10	R1/2	29	14	8		C012A1048
12	R1/8	35	8	5		C012A1218
12	R1/4	32,5	10	6		C012A1228
12	R3/8	32,5	11	8		C012A1238
12	R1/2	32,5	14	8		C012A1248

**Gerade Durchgangsverbindung
C0020**

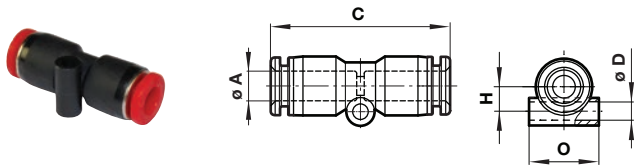

Ø A	C	Ø D	H	O	Typ
4	34,5	3,3	4,5	10,5	C00200400
6	37	3,3	5,5	12,5	C00200600
8	39,5	4,3	7	14,5	C00200800
10	43	4,3	8	17,5	C00201000
12	48	4,3	9,5	20,5	C00201200
16	51	-	-	-	C00201600*

*No nail hole in 16 mm

**Gerade Reduzierverbindung
C0020**

Abmessungen in mm
Projection/First angle

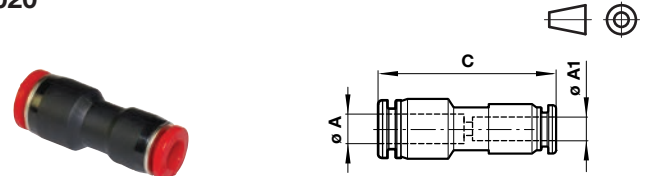

Ø A	Ø A1	C	Typ
6	4	36,5	C00200604
8	4	38,5	C00200804
8	6	37,5	C00200806
10	6	40	C00201006
10	8	41	C00201008
12	8	46	C00201208
12	10	44	C00201210
16	12	49,5	C00201612

**Gerade Reduzier-Steckverbindung
C0023**

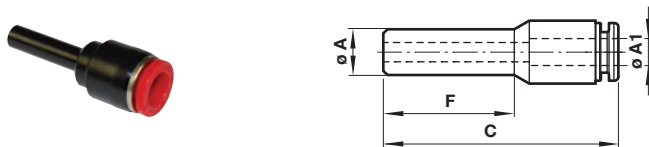

Ø A	Ø A1	C	F	Typ
6	4	41	21,5	C00230604
8	4	42	22,5	C00230804
8	6	44,5	23,5	C00230806
10	6	47,5	26,5	C00231006
10	8	49,5	27,5	C00231008
12	6	52	29,5	C00231206
12	8	52,5	30,5	C00231208
12	10	56,5	31	C00231210
16	12	57,5	33	C00231612

**Doppelstecknippel
C0022**

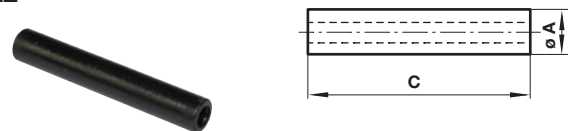

Ø A	C	Typ
4	37	C00220400
6	38	C00220600
8	41	C00220800
10	44	C00221000
12	49	C00221200
16	53	C00221600

**Gerade Aufschraub-Schottverschraubung
(Innengewinde) C0232**

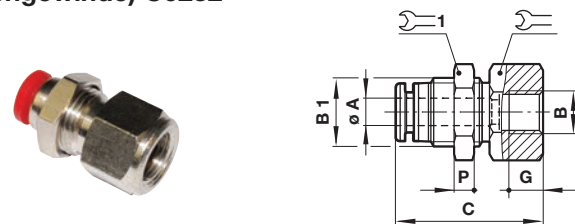

Ø A	B	B1	C	G	P	1	1	Typ
4	G1/8	M12x1	26,5	9	4	14	14	C02320418
4	G1/4	M12x1	29	11	4	14	17	C02320428
4	G3/8	M12x1	30	12	4	14	22	C02320438
6	G1/8	M14x1	28,5	9	4	17	17	C02320618
6	G1/4	M14x1	30,5	11	4	17	17	C02320628
6	G3/8	M14x1	31,5	12	4	17	22	C02320638
8	G1/8	M16x1	29,5	9	5	19	19	C02320818
8	G1/4	M16x1	31,5	11	5	19	19	C02320828
8	G3/8	M16x1	32,5	12	5	19	22	C02320838
10	G1/4	M20x1	32,5	11	5	24	24	C02321028
10	G3/8	M20x1	33,5	12	5	24	24	C02321038
10	G1/2	M20x1	36	14	5	24	24	C02321048
12	G1/4	M22x1	38	11	5	26	24	C02321228
12	G3/8	M22x1	38	12	5	26	24	C02321238
12	G1/2	M22x1	40	14	5	26	24	C02321248

**Gerade Reduzier-Steckverbindung
C0023**

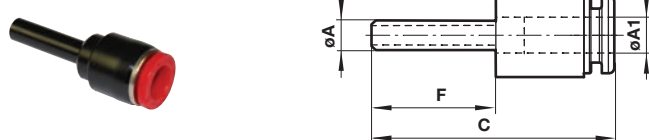

Ø A	Ø A1	C	F	Typ
4	6	41	24	C00230406
6	8	44	26,5	C00230608

**Gerade Schottverbindung
C0029**

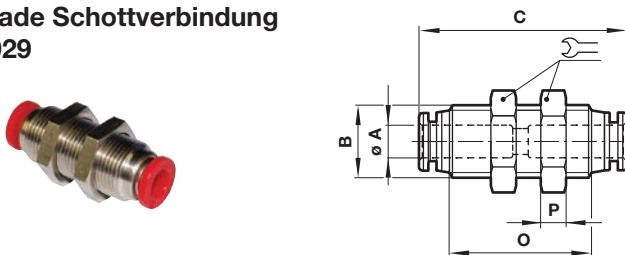

Ø A	B	C	O	P	1	Typ
4	M12x1	35,5	24,5	4	14	C00290400
6	M14x1	40	27,5	4	17	C00290600
8	M16x1	42	29,5	5	19	C00290800
10	M20x1	45	31,5	5	24	C00291000
12	M22x1	50,5	36	5	26	C00291200

**Reduzierstecknippel
 C0022**

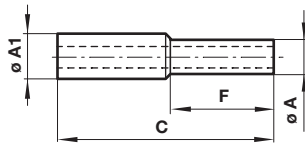

Ø A	Ø A1	C	F	Typ
4	6	38	18	C00220604
6	8	41,5	20,5	C00220806
8	10	43,5	21,5	C00221008
10	12	46,5	22,5	C00221210
12	16	52	25	C00221612

**Stopfen
 C0004**

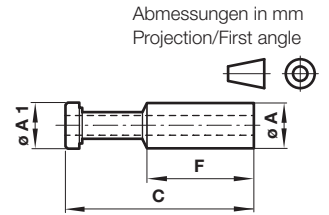

Ø A	Ø A1	C	F	Typ
4	4	30	17,5	C00040400
6	6	34	18,5	C00040600
8	8	38	21	C00040800
10	10	42	24	C00041000
12	12	46	29,5	C00041200
16	16	50	30	C00041600

**Winkelverbindung
 C0040**

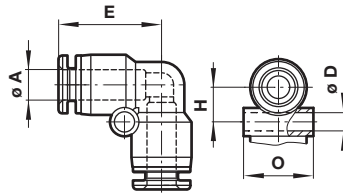

Ø A	Ø D	E	H	O	Typ
4	3,3	19	8,5	10,5	C00400400
6	3,3	21	7,5	12,5	C00400600
8	4,3	22,5	9	14,5	C00400800
10	4,3	26	12	18	C00401000
12	4,3	30	13,5	21	C00401200
16	4,3	34	16	25,5	C00401600

**Verschlusskupplung
 C0012**

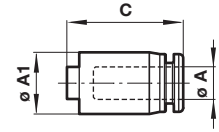

Ø A	Ø A1	C	Typ
4	10,5	18	C00120400
6	12,5	19	C00120600
8	14,5	21	C00120800
10	17,5	23	C00121000
12	19,5	25	C00121200
16	24	25	C00121600

**90° Drehbare Winkel-Einschraubverschraubung
 kegeliges Gewinde
 C0147**

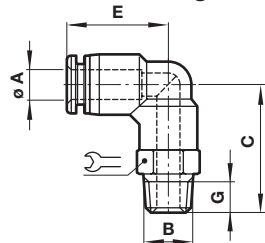

Ø A	B	C	E	G	↺	Typ
4	R1/8	24,5	18,5	8	10	C01470418
4	R1/4	26,5	18,5	10	14	C01470428
4	R3/8	27,5	18,5	11	17	C01470438
6	R1/8	26,5	20,5	8	12	C01470618
6	R1/4	29,5	20,5	10	14	C01470628
6	R3/8	30,5	20,5	11	17	C01470638
6	R1/2	33,5	20,5	14	21	C01470648
8	R1/8	28	23	8	14	C01470818
8	R1/4	31	23	10	14	C01470828
8	R3/8	32	23	11	17	C01470838
8	R1/2	35	23	14	21	C01470848
10	R1/8	28,5	23,5	8	17	C01471018
10	R1/4	31,5	23,5	10	17	C01471028
10	R3/8	32,5	23,5	11	17	C01471038
10	R1/2	35,5	23,5	14	21	C01471048
12	R1/8	32,5	27,5	8	19	C01471218
12	R1/4	34,5	27,5	10	19	C01471228
12	R3/8	35,5	27,5	11	19	C01471238
12	R1/2	38,5	27,5	14	21	C01471248
16	R3/8	43	32,5	11	24	C01471638
16	R1/2	46	32,5	14	24	C01471648

**90° Drehbare Winkel-Einschraubverschraubung
 zylindrisches Gewinde
 C0247**

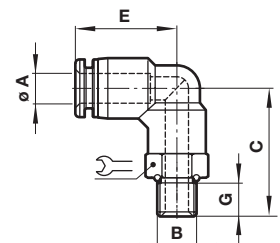

Ø A	B	C	E	G	↺	Typ
4	M5	22	18,5	4,5	10	C02470405
4	M6	22	18,5	4,5	10	C02470406
4	G1/8	22,5	18,5	6	14	C02470418
4	G1/4	24,5	18,5	8	17	C02470428
4	G3/8	24,5	18,5	8	20	C02470438
6	M5	24	20,5	4,5	12	C02470605
6	M6	24	20,5	4,5	12	C02470606
6	G1/8	24,5	20,5	6	14	C02470618
6	G1/4	26,5	20,5	8	17	C02470628
6	G3/8	26,5	20,5	9	20	C02470638
8	G1/8	26	23	8	14	C02470818
8	G1/4	28	23	8	17	C02470828
8	G3/8	28	23	9	20	C02470838
8	G1/2	29	23	10	24	C02470848
10	G1/8	26,5	23,5	6	17	C02471018
10	G1/4	28,5	23,5	8	17	C02471028
10	G3/8	28,5	23,5	9	20	C02471038
10	G1/2	29,5	23,5	10	24	C02471048
12	G1/4	32,5	27,5	8	19	C02471228
12	G3/8	32,5	27,5	9	20	C02471238
12	G1/2	32,5	27,5	10	24	C02471248
16	G3/8	41	32,5	9	24	C02471638
16	G1/2	42	32,5	10	24	C02471648

**Winkel-Steckverbindung
C0043**

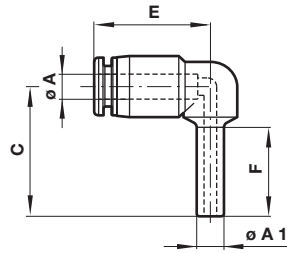

Ø A	Ø A1	C	E	F	Typ
4	4	28,5	19	22	C00430400
6	6	31,5	20,5	24	C00430600
8	8	34,5	23	26	C00430800
10	10	38	24	28	C00431000
12	12	41	28	30	C00431200
16	16	48,5	32	35	C00431600

**90° Drehbare
Winkel-Aufschraubverschraubung
(Innengewinde) C0148/C0248**

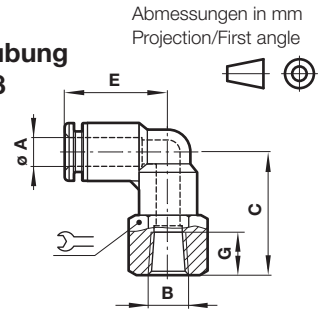

Ø A	B	C	E	G	⌀	Typ
4	M5	21,5	18,5	4,5	10	C02480405
4	M6	21,5	18,5	4,5	10	C02480406
4	R1/8	22,5	18,5	9	14	C01480418
4	R1/4	24,5	18,5	11	17	C01480428
6	M5	23,5	20,5	4,5	12	C02480605
6	M6	23,5	20,5	4,5	12	C02480606
6	R1/8	24,5	20,5	9	14	C01480618
6	R1/4	26,5	20,5	11	17	C01480628
6	R3/8	27,5	20,5	12	21	C01480638
8	R1/8	26	23	9	14	C01480818
8	R1/4	28	23	11	17	C01480828
8	R3/8	29	23	12	22	C01480838
10	R1/4	28,5	23,5	11	17	C01481028
10	R3/8	29,5	23,5	12	22	C01481038
10	R1/2	31,5	23,5	14	24	C01481048
12	R1/4	31,5	27,5	11	19	C01481228
12	R3/8	32,5	27,5	12	22	C01481238
12	R1/2	34,5	27,5	14	24	C01481248

**90° Drehbare Winkel-Einschraubverschraubung
(lange Ausführung)
kegeliges Gewinde
C0154/C0254**

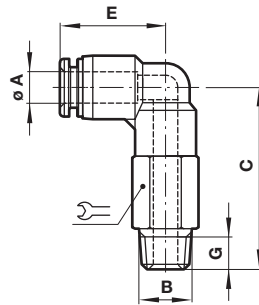

Ø A	B	C	E	G	⌀	Typ
4	M5	33,5	18,5	4,6	10	C02540405
4	M6	33	18,5	4,6	10	C02540406
4	R1/8	35,5	18,5	8	10	C01540418
4	R1/4	37,5	18,5	10	14	C01540428
4	R3/8	38,5	18,5	11	17	C01540438
6	M5	38	20,5	4,5	12	C02540605
6	M6	37,5	20,5	4,5	12	C02540606
6	R1/8	40	20,5	8	12	C01540618
6	R1/4	42	20,5	10	14	C01540628
6	R3/8	43	20,5	11	17	C01540638
6	R1/2	46	20,5	14	21	C01540648
8	R1/8	44	23	8	14	C01540818
8	R1/4	46	23	10	14	C01540828
8	R3/8	47	23	11	17	C01540838
8	R1/2	50	23	14	21	C01540848
10	R1/8	47,5	23,5	8	17	C01541018
10	R1/4	49,5	23,5	10	17	C01541028
10	R3/8	50,5	23,5	11	17	C01541038
10	R1/2	53,5	23,5	14	21	C01541048
12	R1/8	54	27,5	8	19	C01541218
12	R1/4	56	27,5	10	19	C01541228
12	R3/8	57	27,5	11	19	C01541238
12	R1/2	60	27,5	14	21	C01541248
16	R3/8	69	32,5	11	24	C01541638
16	R1/2	72	32,5	14	24	C01541648

**Winkel-Schottverbindung
C0049**

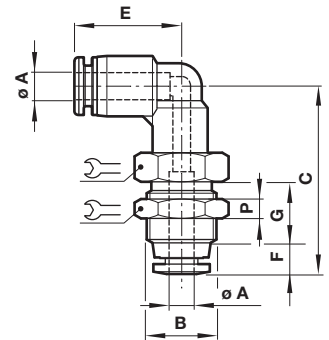

Ø A	B	C	E	F	G	P	⌀	Typ
4	M12x1	32,5	18,5	5,5	9	4	14	C00490400
6	M14x1	38	20,5	6	11	4	17	C00490600
8	M16x1	40,5	23	6,5	11,5	5	19	C00490800
10	M20x1	42,5	23,5	7	12	5	24	C00491000
12	M22x1	48	27,5	7,5	15	5	26	C00491200

**Y-Verbindung
C0082**

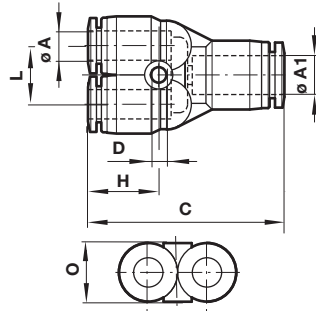

Y-Verbindung

Ø A	Ø A1	C	D	H	L	O	Typ
4	4	37	3,3	14,5	10,5	10,5	C00820400
6	6	40	3,3	16,5	12,5	12,5	C00820600
8	8	43	4,3	18,5	14,5	14,5	C00820800
10	10	47,5	4,3	19	17,5	17,5	C00821000
12	12	53	4,3	22	20,5	20,5	C00821200

Y-Reduzierverbindung

Ø A	Ø A1	C	D	H	L	O	Typ
4	6	38	3,3	15	10,5	10,5	C00820604
4	8	39,5	3,3	15	10,5	15	C00820804
6	8	41	4,3	16	12,5	13	C00820806
6	10	43	3,3	16,5	13	17,5	C00821006
8	10	43	4,3	17	14,5	15	C00821008
8	12	48	3,3	17,5	15	21	C00821208
10	12	46,5	4,3	18,5	17,5	18	C00821210

**Drehbare Y-Einschraubverschraubung
kegeliges Gewinde
C0188**

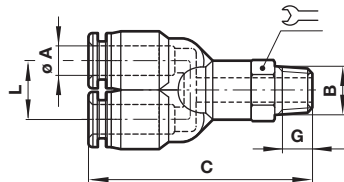

Ø A	B	C	G	L	Typ
4	R1/8	41,5	8	10,5	C01880418
4	R1/4	42,5	10	10,5	C01880428
4	R3/8	43,5	11	10,5	C01880438
6	R1/8	44	8	12,5	C01880618
6	R1/4	47	10	12,5	C01880628
6	R3/8	48	11	12,5	C01880638
6	R1/2	51	14	12,5	C01880648
8	R1/8	45,5	8	14,5	C01880818
8	R1/4	48,5	10	14,5	C01880828
8	R3/8	48,5	11	14,5	C01880838
8	R1/2	52,5	14	14,5	C01880848
10	R1/8	49	8	17,5	C01881018
10	R1/4	52	10	17,5	C01881028
10	R3/8	53	11	17,5	C01881038
10	R1/2	56,2	14	17,5	C01881048
12	R1/8	52,5	3	20,5	C01881218
12	R1/4	54,5	8	20,5	C01881228
12	R3/8	55,5	11	20,5	C01881238
12	R1/2	58,5	14	20,5	C01881248

**Drehbare
Y-Einschraubverschraubung
zylindrisches Gewinde C0288**

Abmessungen in mm
Projection/First angle

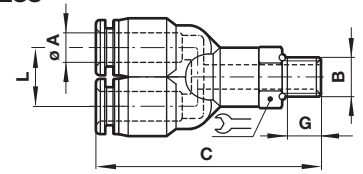

Ø A	B	C	G	L	Typ
4	M5	35	4,5	10,5	C02880405
4	M6	35	4,5	10,5	C02880406
4	G1/8	41	6	10,5	C02880418
4	G1/4	43	8	10,5	C02880428
4	G3/8	43	8	10,5	C02880438
6	M5	41,5	4,5	12,5	C02880605
6	M6	41,5	4,5	12,5	C02880606
6	G1/8	42,5	6	12,5	C02880618
6	G1/4	44,5	8	12,5	C02880628
6	G3/8	45,5	9	12,5	C02880638
6	G1/2	46,5	10	12,5	C02880648
8	G1/8	43,5	6	14,5	C02880818
8	G1/4	45,5	8	14,5	C02880828
8	G3/8	46,5	9	14,5	C02880838
8	G1/2	47,5	10	14,5	C02880848
10	G1/8	49,5	6	17,5	C02881018
10	G1/4	51,5	8	17,5	C02881028
10	G3/8	52,5	9	17,5	C02881038
10	G1/2	53,5	10	17,5	C02881048
12	G1/4	55	8	20,5	C02881228
12	G3/8	56	9	20,5	C02881238
12	G1/2	57	10	20,5	C02881248

**Y-Steckverbindung
C0084**

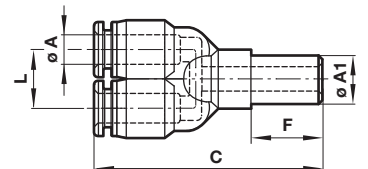

Y-Steckverbindung

Ø A	Ø A1	C	F	L	Typ
4	4	49,5	22	10,5	C00840400
6	6	54,5	24	12,5	C00840600
8	8	60	26	14,5	C00840800
10	10	66	28	17,5	C00841000
12	12	71,5	30	20,5	C00841200

Y-Reduziersteckverbindung

Ø A	Ø A1	C	F	L	Typ
4	6	51,5	24	10,5	C00840604
6	8	56,5	26	12,5	C00840806
8	10	62	28	14,5	C00841008
10	12	68	30	17,5	C00841210

**Mehrfachverteiler 4-fach
C0096**

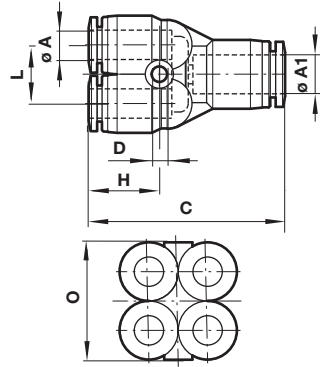

Ø A	Ø A1	C	Ø D	H	L	O	Typ
4	6	37	3,3	14	10,5	21	C00960604
6	8	40,5	3,3	15,5	12,5	25,5	C00960806

**Mehrfachverteiler 4-fach,
zylindrisches Gewinde
C0295**

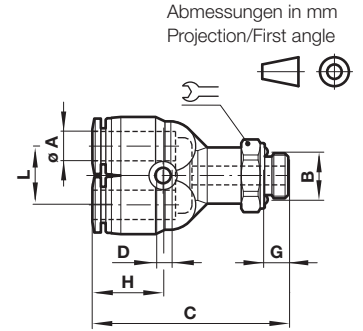

Ø A	B	C	Ø D	G	H	L	O*	Typ
4	G1/8	46	3,3	5	14	10,5	21	C02950418
4	G1/4	49	3,3	6,5	14	10,5	21	C02950428
6	G1/8	49	3,3	6,5	15,5	12,5	25,5	C02950618
6	G1/4	52	3,3	8	15,5	12,5	25,5	C02950628

* Siehe Zeichnung Serie C0096

**Mehrfachverteiler 4-fach,
kegeliges Gewinde
C0195**

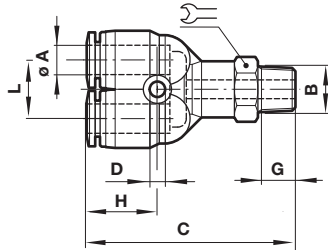

Ø A	B	C	Ø D	G	H	L	O	Typ
4	R1/8	44	3,3	8	14	10,5	21	C01950418
4	R1/4	48	3,3	10	14	10,5	21	C01950428
6	R1/8	48	3,3	8	15,5	12,5	25,5	C01950618
6	R1/4	51	3,3	10	15,5	12,5	25,5	C01950628

* Siehe Zeichnung Serie C0096

**Mehrfach-Steckverteiler 4-fach
C0097**

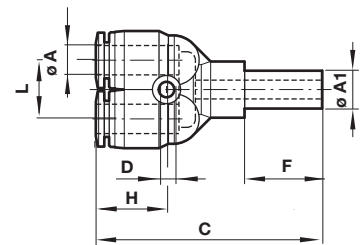

Ø A	Ø A1	C	Ø D	F	H	L	O*	Typ
4	6	43,5	3,3	17	14	12,5	21	C00970604
6	8	48	3,3	19	15,5	14,5	25,5	C00970806

* Siehe Zeichnung Serie C0096

**T-Verbindung
C0060**

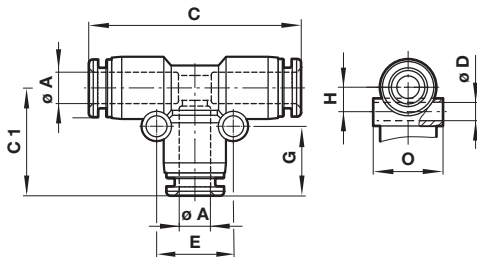

Ø A	C	C1	Ø D	E	G	H	O	Typ
4	36,5	19	3,3	13	12,5	8,5	10,5	C00600400
6	42	21,5	3,3	15	13,5	7,5	12,5	C00600600
8	45	23,5	4,3	18	15	9	14,5	C00600800
10	48	25,5	4,3	20	15,5	11	17,5	C00601000
12	57	29,5	4,3	26	16,5	12,5	20,5	C00601200
16	68	34,5	4,3	32	18	16	25,5	C00601600

**T-Reduzierverbindung
C006A**

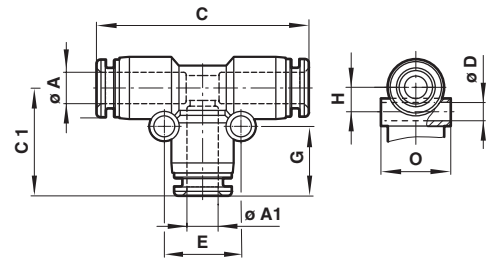

Ø A	Ø A1	C	C1	Ø D	E	G	H	O	Typ
6	4	41,5	19	3,3	14	12,5	8	12,5	C006A0604
8	6	45	22	4,3	17	13,5	9,5	15	C006A0806
10	6	49	23	4,3	17	13,5	11	17,5	C006A1006
10	8	49	25	4,3	19	15	11	17,5	C006A1008
12	8	56	25,5	4,3	19	15	12,5	20,5	C006A1208
12	10	56	27,5	4,3	22	15,5	12,5	20,5	C006A1210
16	10	61	30,5	4,3	23	15,5	16	25,5	C006A1610
16	12	63,5	33	4,3	26	16,5	16	25,5	C006A1612

**Drehbare T-Einschraubverschraubung
kegeliges Gewinde
C0167**

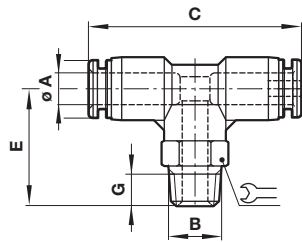

Ø A	B	C	E	G		Typ
4	R1/8	37,5	24,5	8	10	C01670418
4	R1/4	37,5	26,5	10	14	C01670428
4	R3/8	37,5	27,5	11	17	C01670438
6	R1/8	41	26,5	8	12	C01670618
6	R1/4	41	29,5	10	14	C01670628
6	R3/8	41	30,5	11	17	C01670638
6	R1/2	41	33,5	14	21	C01670648
8	R1/8	44	28	8	14	C01670818
8	R1/4	44	31	10	14	C01670828
8	R3/8	44	32	11	17	C01670838
8	R1/2	44	35	14	21	C01670848
10	R1/8	47	28,5	8	17	C01671018
10	R1/4	47	32	10	17	C01671028
10	R3/8	47	32,5	11	17	C01671038
10	R1/2	47	35,5	14	21	C01671048
12	R1/8	55	32,5	8	19	C01671218
12	R1/4	55	34,5	10	19	C01671228
12	R3/8	55	35,5	11	19	C01671238
12	R1/2	55	38,5	14	21	C01671248
16	R3/8	64,5	43	11	24	C01671638
16	R1/2	64,5	46	14	24	C01671648

**Drehbare T-Einschraubverschraubung
zylindrisches Gewinde
C0267**

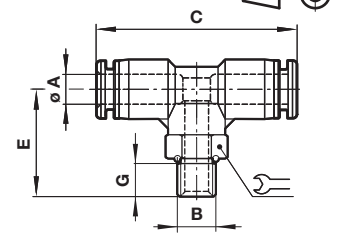

Abmessungen in mm
Projection/First angle

Ø A	B	C	E	G		Typ
4	M5	37,5	22	4,5	10	C02670405
4	M6	37,5	22	4,5	10	C02670406
4	G1/8	37,5	22	6	14	C02670418
4	G1/4	37,5	24	8	17	C02670428
4	G3/8	37,5	24	8	20	C02670438
6	M5	41	24	4,5	12	C02670605
6	M6	41	24	4,5	12	C02670606
6	G1/8	41	24,5	6	14	C02670618
6	G1/4	41	26,5	8	17	C02670628
6	G3/8	41	27,5	9	20	C02670638
6	G1/2	41	28,5	9	24	C02670648
8	G1/8	44,5	26	6	14	C02670818
8	G1/4	44,5	28	8	17	C02670828
8	G3/8	44,5	29	9	20	C02670838
8	G1/2	44,5	30	10	24	C02670848
10	G1/8	47	26,5	6	17	C02671018
10	G1/4	47	28,5	8	17	C02671028
10	G3/8	47	29,5	9	20	C02671038
10	G1/2	47	30,5	10	24	C02671048
12	G1/4	55	31,5	8	19	C02671228
12	G3/8	55	32,5	9	20	C02671238
12	G1/2	55	33,5	10	24	C02671248
16	G3/8	64,5	40	9	24	C02671638
16	G1/2	64,5	41	10	24	C02671648

**Drehbare
T-Einschraubverschraubung
seitlich C016C/C026C**

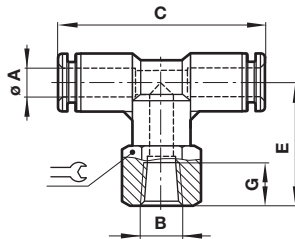

Ø A	B	C	E	G		Typ
4	M5	37,5	17	8	10	C026C0405
4	M6	37,5	17	8	10	C026C0406
4	R1/8	38	17	9	14	C016C0418
4	R1/4	38	17	11	17	C016C0428
6	M5	41	17,5	8	12	C026C0605
6	M6	41	17,5	8	12	C026C0606
6	R1/8	41	17,5	9	14	C016C0618
6	R1/4	41	17,5	11	17	C016C0628
6	R3/8	41	17,5	12	22	C016C0638
8	R1/8	44,5	18,5	9	14	C016C0818
8	R1/4	44,5	18,5	11	17	C016C0828
8	R3/8	44,5	18,5	12	22	C016C0838
8	R1/2	44,5	18,5	14	24	C016C0848
10	R1/8	47	19,5	9	17	C016C1018
10	R1/4	47	19,5	11	17	C016C1028
10	R3/8	47	19,5	12	22	C016C1038
10	R1/2	47	19,5	14	24	C016C1048
12	R1/4	55	22	11	19	C016C1228
12	R3/8	55	22	12	22	C016C1238
12	R1/2	55	22	14	24	C016C1248

**T-Steckverbindung
C0063**

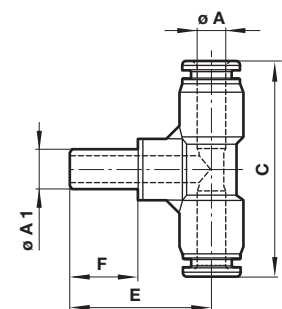

T-Steckverbindung

Ø A	Ø A1	C	E	F	Typ
4	4	37,5	32,5	24	C00630400
6	6	41	34,5	25	C00630600
8	8	44,5	36	26	C00630800
10	10	47	37,5	28	C00631000
12	12	55	39	30	C00631200

T-Reduziersteckverbindung

Ø A	Ø A1	C	E	F	Typ
4	6	37,5	33,5	25	C00630604
6	8	41	35,5	28	C00630806
8	10	44,5	38,5	28	C00631008
10	12	47	39,5	30	C00631210

**T-Steckverbindung, seitlich
C0064**

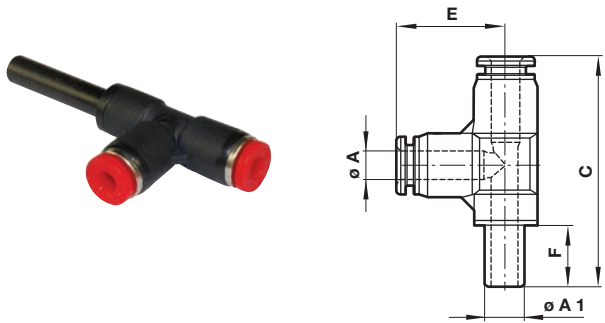

T-Steckverbindung, seitlich

Ø A	Ø A1	C	E	F	Typ
4	4	58	20,5	17	C00640400
6	6	52,5	21,5	17,5	C00640600
8	8	67	23,5	18,5	C00640800
10	10	73	25,5	19,5	C00641000
12	12	82	30	22	C00641200

T-Reduziersteckverbindung, seitlich

Ø A	Ø A1	C	E	F	Typ
4	6	59	20	17	C00640604
6	8	63,5	21,5	17,5	C00640806
8	10	69,5	23,5	18,5	C00641008
10	12	75	25,5	19,5	C00641210

**Drehbare T-Einschraubverschraubung,
seitlich, kegeliges Gewinde
C0168**

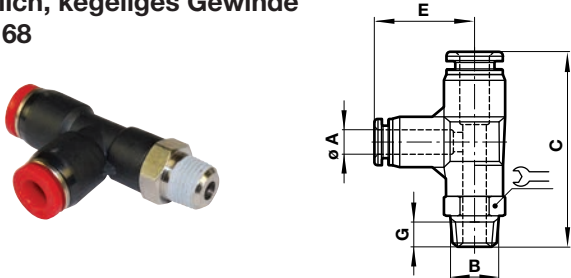

Ø A	B	C	E	G	Typ
4	R1/8	45	20	8	C01680418
4	R1/4	48	20	10	C01680428
4	R3/8	49	20	11	C01680438
6	R1/8	48,5	21,5	8	C01680618
6	R1/4	51	21,5	10	C01680628
6	R3/8	52	21,5	11	C01680638
6	R1/2	55	21,5	14	C01680648
8	R1/8	52	23,5	8	C01680818
8	R1/4	55	23,5	10	C01680828
8	R3/8	56	23,5	11	C01680838
8	R1/2	59	23,5	14	C01680848
10	R1/8	55,5	25,5	8	C01681018
10	R1/4	58,5	25,5	10	C01681028
10	R3/8	59,5	25,5	11	C01681038
10	R1/2	62,5	25,5	14	C01681048
12	R1/8	63	30	8	C01681218
12	R1/4	65	30	10	C01681228
12	R3/8	66	30	11	C01681238
12	R1/2	69	30	14	C01681248

**Drehbare
T-Einschraubverschraubung, seitlich,
zylindrisches
Gewinde C0268**

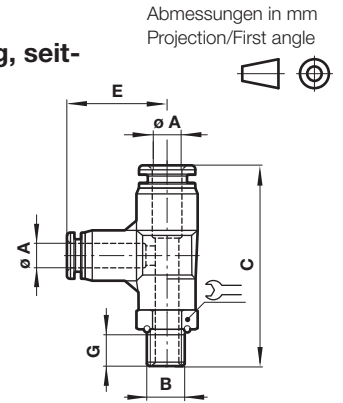

Ø A	B	C	E	G	Typ
4	M5	42	20	4,5	C02680405
4	M6	42	20	4,5	C02680406
4	G1/8	43	20	6	C02680418
4	G1/4	45	20	8	C02680428
4	G3/8	45	20	8	C02680438
6	M5	46	21,5	4,5	C02680605
6	M6	46	21,5	4,5	C02680606
6	G1/8	47	21,5	6	C02680618
6	G1/4	49	21,5	8	C02680628
6	G3/8	50	21,5	9	C02680638
8	G1/8	50	23,5	6	C02680818
8	G1/4	52	23,5	8	C02680828
8	G3/8	56	23,5	9	C02680838
8	G1/2	54	23,5	10	C02680848
10	G1/8	54	25,5	6	C02681018
10	G1/4	56	25,5	8	C02681028
10	G3/8	57	25,5	9	C02681038
10	G1/2	58	25,5	10	C02681048
12	G1/4	62	30	8	C02681228
12	G3/8	63	30	9	C02681238
12	G1/2	64	30	10	C02681248

**Kreuzverbindung
C0090**

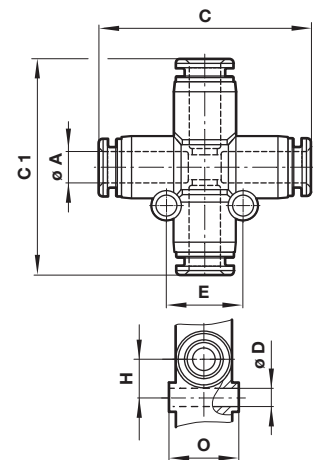

Ø A	C	C1	Ø D	E	H	O	Typ
4	36,5	38	3,3	13	6,5	10,5	C00900400
6	42	42,5	4,3	15	7,5	12,5	C00900600
8	45	47	4,3	18	9	14,5	C00900800
10	48	50,5	4,3	20	10	17,5	C00901000
12	55	57	4,3	24	12	20,5	C00901200

**Mehrfachverteiler, 4-fach
C00D3**

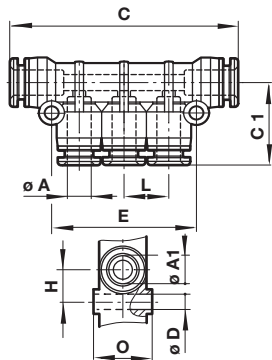

Ø A	Ø A1	C	C1	D	E	H	L	O	Typ
4	6	63,5	18	3,3	34	7,5	10,5	12,5	C00D30604
4	8	65,5	21,5	4,3	35	9	10,5	14,5	C00D30804
6	8	71,5	22,5	4,3	41	9,5	12,5	14,5	C00D30806
6	10	78	23,5	4,3	42	9,5	12,5	17,5	C00D31006
8	10	83,5	26	4,3	47	9,5	14,5	17,5	C00D31008

**Mehrfach-Einschraubverteiler, 4-fach,
kegeliges Gewinde
C01D3**

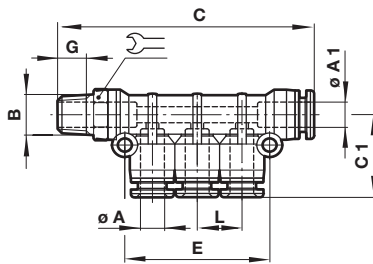

Ø A	Ø A1	B	C	C1	E	G	L	Typ	
4	6	R1/8	72	24	34	8	10,5	12	C01D30418
4	8	R1/8	74	28,5	35	8	10,5	14	C01D30428
6	8	R1/4	82,5	34	41	10	12,5	14	C01D30628
8	10	R3/8	95	34,5	47	10	14,5	17	C01D30838

**Stem manifold
C00J3**

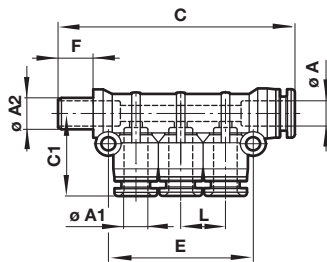

Ø A	Ø A1	Ø A2	C	C1	E	F	L	Typ
4	6	6	84,5	24	34	25	10,5	C00J30604
4	8	8	89,5	28,5	35	28,5	10,5	C00J30804
6	8	8	95,5	34	41	28,5	12,5	C00J30806
8	10	10	109,5	34,5	47	31	14,5	C00J31008

**Schwenkverschraubung,
zylindrisches Gewinde
C0A51**



Abmessungen in mm
Projection/First angle

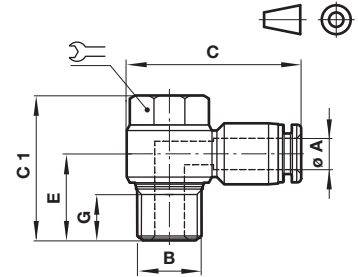

Ø A	B	C	C1	E	G	Typ	
4	M5	25	18	10	3,5	8	C0A510405
4	G1/8	30,5	25	14,5	11	8	C0A510418
4	G1/4	34,5	29	16,5	10	8	C0A510428
6	M5	27,5	18	11,5	3,5	8	C0A510605
6	G1/8	31	25	14,5	8	8	C0A510618
6	G1/4	35	29	16,5	10	12	C0A510628
6	G3/8	38,5	32,5	20,5	11	14	C0A510638
8	G1/8	33	25	13,5	8	8	C0A510818
8	G1/4	37	29	16	10	12	C0A510828
8	G3/8	40	32,5	20,5	11	14	C0A510838
8	G1/2	46	39,5	23	14	17	C0A510848
10	G1/4	39	29	15,5	10	12	C0A511028
10	G3/8	42	32,5	19,5	11	14	C0A511038
10	G1/2	47,5	39,5	23	14	17	C0A511048
12	G3/8	46	32,5	18,5	11	14	C0A511238
12	G1/2	50	39,5	21,5	14	17	C0A511248

**Winkel-Schwenkverschraubung
mit stirnseitigem Anschluss
C0D51/C0E51/C0F51/C0G51**

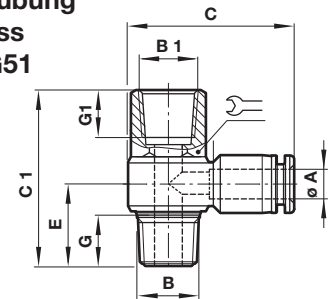

Ø A	B & B1	C	C1	E	G	G1	Typ	
4	M5	25	20	10	3,5	6	8	C0D510405
4	R1/8	30,5	30	14,5	9	8	14	C0E510418
4	R1/4	34,5	35,5	18	11	10	17	C0F510428
6	M5	28	20	11	3,5	6	8	C0D510605
6	R1/8	31	30	14,5	9	8	14	C0E510618
6	R1/4	35	35,5	18	11	10	17	C0F510628
6	R3/8	38,5	41	21	12	11	21	C0G510638
8	R1/8	33	30	15,5	9	8	14	C0E510818
8	R1/4	38	35,5	19	11	10	17	C0F510828
8	R3/8	40	41	21	12	11	21	C0G510838
10	R1/4	39	35,5	20	11	10	17	C0F511028
10	R3/8	42	41	22,5	12	11	21	C0G511038
12	R3/8	46	41	23	12	11	21	C0G511238

**Schwenkverschraubung 2-fach,
kegeliges Gewinde
C0Q51**

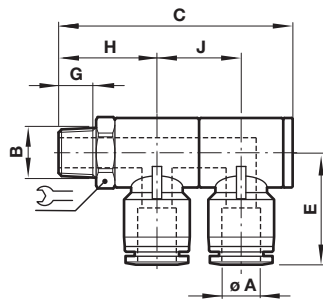

Ø A	B	C	E	G	H	J	Wrench	Typ
4	R1/8	52	24	8	22,5	18	14	C0Q510418
4	R1/4	63	26	10	27,5	22	17	C0Q510428
4	R3/8	65	28	11	29	22	21	C0Q510438
4	R1/2	74	30	14	34	24	24	C0Q510448
6	R1/8	52	25	8	22,5	18	14	C0Q510618
6	R1/4	63	27	10	27,5	22	17	C0Q510628
6	R3/8	65	28,5	11	29	22	21	C0Q510638
6	R1/2	74	30	14	34	24	24	C0Q510648
8	R1/8	52	27	8	22,5	18	14	C0Q510818
8	R1/4	63	28,5	10	27,5	22	17	C0Q510828
8	R3/8	65	30,5	11	29	22	21	C0Q510838
8	R1/2	74	32	14	34	24	24	C0Q510848
10	R1/8	52	28,5	8	22,5	18	14	C0Q511018
10	R1/4	63	30,5	10	27,5	22	17	C0Q511028
10	R3/8	65	32,5	11	29	22	21	C0Q511038
10	R1/2	74	34,5	14	34	24	24	C0Q511048
12	R1/4	63	36	10	27,5	22	17	C0Q511228
12	R3/8	65	36	11	29	22	21	C0Q511238
12	R1/2	74	38	14	34	24	24	C0Q511248

**Schwenkverschraubung
3-fach, kegeliges Gewinde
C0H51**

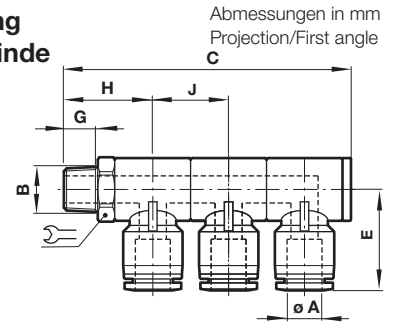

Ø A	B	C	E	G	H	J	Wrench	Typ
4	R1/8	70	24	8	22,5	18	14	C0H510418
4	R1/4	85	26	10	27,5	22	17	C0H510428
4	R3/8	87	28	11	29	22	21	C0H510438
4	R1/2	97,5	30	14	34	24	24	C0H510448
6	R1/8	70	25	8	22,5	18	14	C0H510618
6	R1/4	85	27	10	27,5	22	17	C0H510628
6	R3/8	87	28,5	11	29	22	21	C0H510638
6	R1/2	97,5	30	14	34	24	24	C0H510648
8	R1/8	70	27	8	22,5	18	14	C0H510818
8	R1/4	85	28,5	10	27,5	22	17	C0H510828
8	R3/8	87	30,5	11	29	22	21	C0H510838
8	R1/2	97,5	32	14	34	24	24	C0H510848
10	R1/8	70	28,5	8	22,5	18	14	C0H511018
10	R1/4	85	30,5	10	27,5	22	17	C0H511028
10	R3/8	87	32,5	11	29	22	21	C0H511038
10	R1/2	97,5	34,5	14	34	24	24	C0H511048
12	R1/4	85	36	10	27,5	22	17	C0H511228
12	R3/8	87	36	11	29	22	21	C0H511238
12	R1/2	87,5	38	14	34	24	24	C0H511248

**Schwenkverschraubung 2-fach,
zylindrisches Gewinde
C0B51**

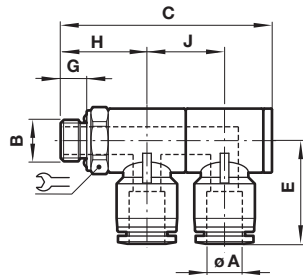

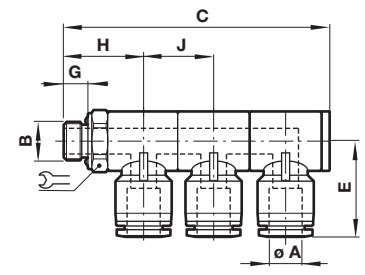

Ø A	B	C	E	G	H	J	Wrench	Typ
4	G1/8	50	24	5	20,5	18	14	C0B510418
4	G1/4	61	26	6,5	25,5	22	17	C0B510428
4	G3/8	62	28	6,5	26	22	21	C0B510438
4	G1/2	70	30	8	29,5	24	24	C0B510448
6	G1/8	50	25	5	20,5	18	14	C0B510618
6	G1/4	61	27	6,5	25,5	22	17	C0B510628
6	G3/8	62	28,5	6,5	26	22	21	C0B510638
6	G1/2	70	30	8	29,5	24	24	C0B510648
8	G1/8	50	27	5	20,5	18	14	C0B510818
8	G1/4	61	28,5	6,5	25,5	22	17	C0B510828
8	G3/8	62	30,5	6,5	26	22	21	C0B510838
8	G1/2	70	32	8	29,5	24	24	C0B510848
10	G1/8	50	28,5	5	20,5	18	14	C0B511018
10	G1/4	61	30,5	6,5	25,5	22	17	C0B511028
10	G3/8	62	32,5	6,5	26	22	21	C0B511038
10	G1/2	70	34,5	8	29,5	24	24	C0B511048
12	G1/4	61	36	6,5	25,5	22	17	C0B511228
12	G3/8	62	36	6,5	26	22	21	C0B511238
12	G1/2	70	38	8	29,5	24	24	C0B511248

**Schwenkverschraubung 3-fach,
zylindrisches Gewinde
C0C51**



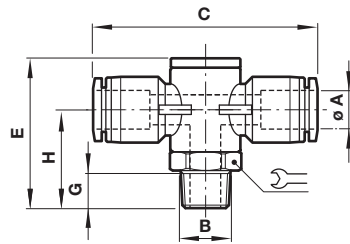

Ø A	B	C	E	G	H	J	Wrench	Typ
4	G1/8	68	24	5	20,5	18	14	C0C510418
4	G1/4	83	26	6,5	25,5	22	17	C0C510428
4	G3/8	84	28	6,5	26	22	21	C0C510438
4	G1/2	93	30	8	29,5	24	24	C0C510448
6	G1/8	68	25	5	20,5	18	14	C0C510618
6	G1/4	83	27	6,5	25,5	22	17	C0C510628
6	G3/8	84	28,5	6,5	26	22	21	C0C510638
6	G1/2	93	30	8	29,5	24	24	C0C510648
8	G1/8	68	27	5	20,5	18	14	C0C510818
8	G1/4	83	28,5	6,5	25,5	22	17	C0C510828
8	G3/8	84	30,5	6,5	26	22	21	C0C510838
8	G1/2	93	32	8	29,5	24	24	C0C510848
10	G1/8	68	28,5	5	20,5	18	14	C0C511018
10	G1/4	83	30,5	6,5	25,5	22	17	C0C511028
10	G3/8	84	32,5	6,5	26	22	21	C0C511038
10	G1/2	83	34,5	8	29,5	24	24	C0C511048
12	G1/4	83	34	6,5	25,5	22	17	C0C511228
12	G3/8	84	35	6,5	26	22	21	C0C511238
12	G1/2	93	38	8	29,5	24	24	C0C511248

T-Schwenkverschraubung, kegeliges Gewinde
C0N71

Ø A	B	C	E	G	H		Typ
4	R1/8	47	34	8	25,5	14	C0N710418
4	R1/4	50,5	41	10	27,5	17	C0N710428
4	R3/8	54,5	43	11	29	21	C0N710438
4	R1/2	58,5	50	14	34	24	C0N710448
6	R1/8	48,5	34	8	22,5	14	C0N710618
6	R1/4	52	41	10	27,5	17	C0N710628
6	R3/8	56	43	11	29	21	C0N710638
6	R1/2	58,5	50	14	34	24	C0N710648
8	R1/8	52	34	8	22,5	14	C0N710818
8	R1/4	55,5	41	10	27,5	17	C0N710828
8	R3/8	59,5	43	11	29	21	C0N710838
8	R1/2	63,5	50	14	34	24	C0N710848
10	R1/8	56	34	8	22,5	14	C0N711018
10	R1/4	59,5	41	10	27,5	17	C0N711028
10	R3/8	63,5	43	11	29	21	C0N711038
10	R1/2	67	50	14	34	24	C0N711048
12	R1/4	66	41	10	27,5	17	C0N711228
12	R3/8	70	43	11	29	21	C0N711238
12	R1/2	74,5	50	14	34	24	C0N711248

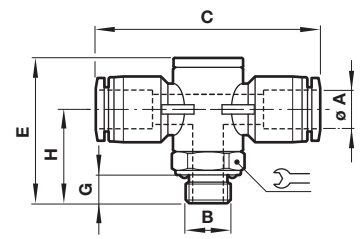
T-Schwenkverschraubung,
zylindrisches Gewinde
C0A71

 Abmessungen in mm
 Projection/First angle

Ø A	B	C	E	G	H		Typ
4	G1/8	47	32	5	20,5	14	C0A710418
4	G1/4	50,5	39	6,5	25,5	17	C0A710428
4	G3/8	54,5	40	6,5	26	21	C0A710438
4	G1/2	58,5	45,5	8	29,5	24	C0A710448
6	G1/8	48,5	32	5	20,5	14	C0A710618
6	G1/4	52	39	6,5	25,5	17	C0A710628
6	G3/8	56	40	6,5	26	21	C0A710638
6	G1/2	58,5	45,5	8	29,5	24	C0A710648
8	G1/8	52	32	5	20,5	14	C0A710818
8	G1/4	55,5	39	6,5	25,5	17	C0A710828
8	G3/8	59,5	40	6,5	26	21	C0A710838
8	G1/2	62,5	45,5	8	29,5	24	C0A710848
10	G1/8	56	32	5	20,5	14	C0A711018
10	G1/4	59,5	39	6,5	25,5	17	C0A711028
10	G3/8	63,5	40	6,5	26	21	C0A711038
10	G1/2	67	45,5	8	29,5	24	C0A711048
12	G1/4	66	39	6,5	25,5	17	C0A711228
12	G3/8	70	40	6,5	26	21	C0A711238
12	G 1/2	74,5	45,5	8	29,5	24	C0A711248

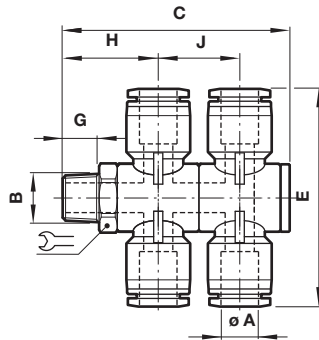
T-Schwenkverschraubung
2-fach kegeliges Gewinde
C0Q71

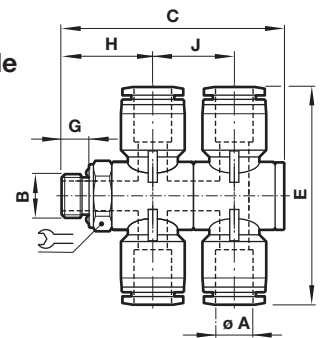

Ø A	B	C	E	G	H	J		Typ
4	R1/8	52	47	8	22,5	18	14	C0Q710418
4	R1/4	63	50,5	10	27,5	22	17	C0Q710428
4	R3/8	65	54,5	11	29	22	21	C0Q710438
4	R1/2	74	58,5	14	34	24	24	C0Q710448
6	R1/8	52	48,5	8	22,5	18	14	C0Q710618
6	R1/4	63	52	10	27,5	22	17	C0Q710628
6	R3/8	65	56	11	29	22	21	C0Q710638
6	R1/2	74	58,5	14	34	24	24	C0Q710648
8	R1/8	52	52	8	22,5	18	14	C0Q710818
8	R1/4	63	55,5	10	27,5	22	17	C0Q710828
8	R3/8	65	59,5	11	29	22	21	C0Q710838
8	R1/2	74	62,5	14	34	24	24	C0Q710848
10	R1/8	52	56	8	22,5	18	14	C0Q711018
10	R1/4	63	59,5	10	27,5	22	17	C0Q711028
10	R3/8	65	63,5	11	29	22	21	C0Q711038
10	R1/2	74	67	14	34	24	24	C0Q711048
12	R1/4	63	66	10	27,5	21	17	C0Q711228
12	R3/8	65	70	11	29	21	21	C0Q711238
12	R1/2	74	74,5	14	34	24	24	C0Q711248

T-Schwenkverschraubung
2-fach zylindrisches Gewinde
C0B71

Ø A	B	C	E	G	H	J		Typ
4	G1/8	50	47	5	20,5	18	14	C0B710418
4	G1/4	61	50,5	6,5	25,5	22	17	C0B710428
4	G3/8	62	54,5	6,5	26	22	21	C0B710438
4	G1/2	69,5	58,5	8	29,5	24	24	C0B710448
6	G1/8	50	48,5	5	20,5	18	14	C0B710618
6	G1/4	61	52	6,5	25,5	22	17	C0B710628
6	G3/8	62	56	6,5	26	22	21	C0B710638
6	G1/2	69,5	58,5	8	29,5	24	24	C0B710648
8	G1/8	50	52	5	20,5	18	14	C0B710818
8	G1/4	61	55,5	6,5	25,5	22	17	C0B710828
8	G3/8	62	59,5	6,5	26	22	21	C0B710838
8	G1/2	69,5	62,5	8	29,5	24	24	C0B710848
10	G1/8	50	56	5	20,5	18	14	C0B711018
10	G1/4	61	59,5	6,5	25,5	22	17	C0B711028
10	G3/8	62	63,5	6,6	26	22	21	C0B711038
10	G1/2	69,5	67	8	29,5	24	24	C0B711048
12	G1/4	61	66	6,5	25,5	21	17	C0B711228
12	G3/8	62	70	6,5	26	21	21	C0B711238
12	G 1/2	69,5	74,5	8	29,5	24	24	C0B711248

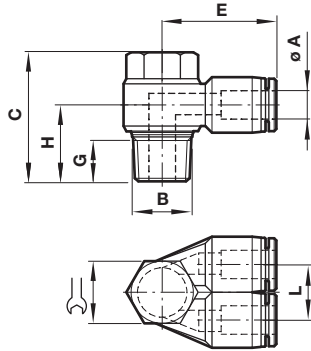
**Schwenkverschraubung, 2-fach
C0N70**



Ø A	B	C	E	G	H	L		Typ
6	R1/8	25	23	8	14,5	12,5	11	C0N700618
8	R1/4	29	28,5	10	18,5	15	15	C0N700828
10	R1/4	29	31	10	19,5	17,5	15	C0N701028
10	R3/8	32,5	31	11	20,5	17,5	19	C0N701038
12	R3/8	32,5	36	11	22	20,5	19	C0N701238
12	R1/2	39,5	36,5	14	25,5	20,5	24	C0N701248

**Schwenkverschraubung, 2-fach
C0A70**

Abmessungen in mm
Projection/First angle

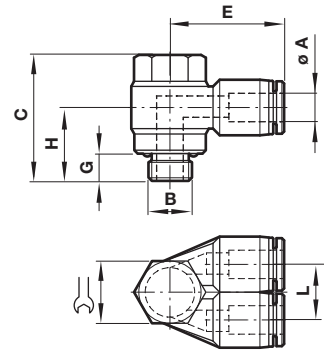

Ø A	B	C	E	G	H	L		Typ
4	M5	18	19,5	3,6	10	10,5	8	C0A700405
6	G1/8	23,5	23	4,5	14	12,5	8	C0A700618
8	G1/4	28	28,5	6	17,5	15	12	C0A700828
10	G1/4	28	31	6	19	17,5	12	C0A701028
10	G3/8	32,5	31	6	21	17,5	14	C0A701038
12	G3/8	32,5	36	6	22,5	20,5	14	C0A701238
12	G1/2	34	36,5	7,5	23	20,5	17	C0A701248

**T-Schwenkverschraubung 3-fach
kegeliges Gewinde
C0H71**

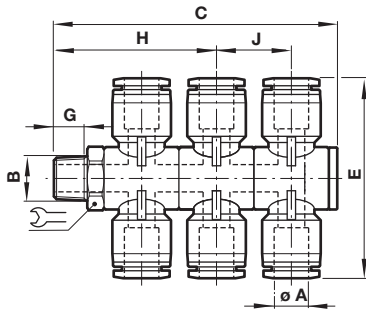

Ø A	B	C	E	G	H	J		Typ
4	R1/8	70	47	8	22,5	18	14	C0H710418
4	R1/4	85	50,5	10	27,5	22	17	C0H710428
4	R3/8	87	54,5	11	29	22	21	C0H710438
4	R1/2	97,5	58,5	14	34	24	24	C0H710448
6	R1/8	70	48,5	8	22,5	18	14	C0H710618
6	R1/4	85	52	10	27,5	22	17	C0H710628
6	R3/8	87	56	11	29	22	21	C0H710638
6	R1/2	97,5	58,5	14	34	24	24	C0H710648
8	R1/8	70	52	8	22,5	18	14	C0H710818
8	R1/4	85	55,5	10	27,5	22	17	C0H710828
8	R3/8	87	59,5	11	29	22	21	C0H710838
8	R1/2	97,5	62,5	14	34	24	24	C0H710848
10	R1/8	70	56	8	22,5	18	14	C0H711018
10	R1/4	85	59,5	10	27,5	22	17	C0H711028
10	R3/8	87	63,5	11	29	22	21	C0H711038
10	R1/2	97,5	67	14	34	24	24	C0H711048
12	R1/4	85	66	10	27,5	21	17	C0H711228
12	R3/8	87	70	11	29	21	21	C0H711238
12	R1/2	97,5	74,5	14	34	24	24	C0H711248

**T-Schwenkverschraubung 3-fach
zylindrisches Gewinde
C0C71**

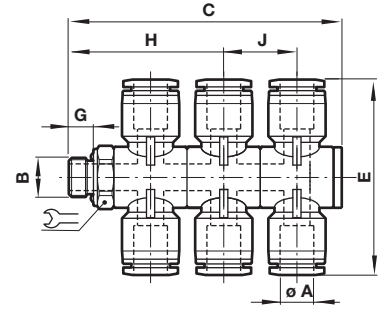

Ø A	B	C	E	G	H	J		Typ
4	G1/8	68	47	5	20,5	18	14	C0C710418
4	G1/4	83	50,5	6,5	25,5	22	17	C0C710428
4	G3/8	84	54,5	6,5	26	22	21	C0C710438
4	G1/2	93	58,5	8	29,5	24	24	C0C710448
6	G1/8	68	48,5	5	20,5	18	14	C0C710618
6	G1/4	83	52	6,5	25,5	22	17	C0C710628
6	G3/8	84	56	6,5	26	22	21	C0C710638
6	G1/2	93	58,5	8	29,5	24	24	C0C710648
8	G1/8	68	52	5	20,5	18	14	C0C710818
8	G1/4	83	55,5	6,5	25,5	22	17	C0C710828
8	G3/8	84	59,5	6,5	26	22	21	C0C710838
8	G1/2	93	62,5	8	29,5	24	24	C0C710848
10	G1/8	68	56	5	20,5	18	14	C0C711018
10	G1/4	83	59,5	6,5	25,5	22	17	C0C711028
10	G3/8	84	63,5	6,6	26	22	21	C0C711038
10	G1/2	93	67	8	29,5	24	24	C0C711048
12	G1/4	83	66	6,5	25,5	21	17	C0C711228
12	G3/8	84	70	6,5	26	21	21	C0C711238
12	G 1/2	93	74,5	8	29,5	24	24	C0C711248

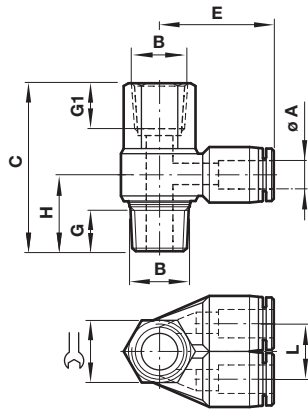
**Durchgangs-Schwenkverschraubung, 2-fach
kegeliges Gewinde
C0*7J**

Ø A	B	C	E	G / G1	H	L	↺	Typ
6	R1/8	30	23	8	14,5	12,5	14	C0E7J0618
8	R1/4	35,5	28,5	10	18,5	15	17	C0F7J0828
10	R1/4	35,5	31	10	19,5	17,5	17	C0F7J1028
10	R3/8	41	31	11	20,5	17,5	21	C0G7J1038
12	R3/8	41	36	11	22	20,5	21	C0G7J1238
12	R1/2	50	36,5	14	25,5	20,5	24	C0H7J1248

**Durchgangs-Schwenkverschraubung, 2-fach zylindrisches Gewinde
C0*7K**

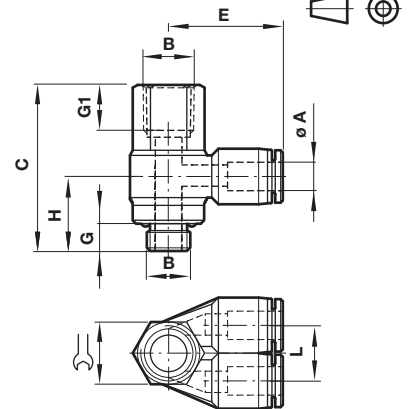
 Abmessungen in mm
 Projection/First angle

Ø A	B	C	E	G / G1	H	L	↺	Typ
4	M5	20	19,5	3,5 / 7	10	10,5	8	C0D7K0405
6	G1/8	30	23	8	14	12,5	14	C0E7K0618
8	G1/4	35,5	27	10	17,5	14,5	17	C0F7K0828
10	G1/4	35,5	28	10	17,5	17,5	17	C0F7K1028
10	G3/8	41	30	11	17,5	17,5	21	C0G7K1038
12	G3/8	41	33	11	17,5	20,5	21	C0G7K1238
12	G1/2	50	35	14	20	20,5	24	C0H7K1248

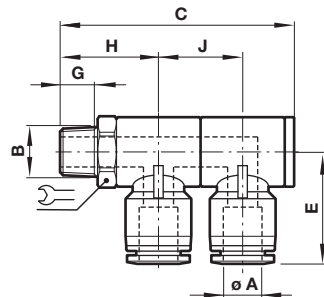
**Schwenkverschraubung, 4-fach kegeliges Gewinde
C0Q70**

Ø A	B	C	E	G	H	J	↺	Typ
4	R1/8	52	24	8	22,5	18	14	C0Q700418
4	R1/4	63	26	10	27,5	22	17	C0Q700428
4	R3/8	65	28	11	29	22	21	C0Q700438
4	R1/2	74	30,5	14	34	24	24	C0Q700448
6	R1/8	52	25	8	22,5	18	14	C0Q700618
6	R1/4	63	27	10	27,5	22	17	C0Q700628
6	R3/8	65	28,5	11	29	22	21	C0Q700638
6	R1/2	74	31	14	34	24	24	C0Q700648
8	R1/8	52	27	8	22,5	18	14	C0Q700818
8	R1/4	63	30,5	10	27,5	22	17	C0Q700828
8	R3/8	65	30,5	11	29	22	21	C0Q700838
8	R1/2	74	32,5	14	34	24	24	C0Q700848
10	R1/8	52	28,5	8	22,5	18	14	C0Q701018
10	R1/4	63	30,5	10	27,5	22	17	C0Q701028
10	R3/8	65	32,5	11	29	22	21	C0Q701038
10	R1/2	74	35	14	34	24	24	C0Q701048
12	R1/4	63	34	10	27,5	22	17	C0Q701228
12	R3/8	65	35	11	29	22	21	C0Q701238
12	R1/2	74	39	14	34	24	24	C0Q701248

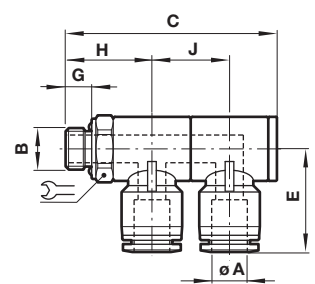
**Schwenkverschraubung, 4-fach zylindrisches Gewinde
C0B70**

Ø A	B	C	E	G	H	J	↺	Typ
4	G1/8	50	24	5	20,5	18	14	C0B700418
4	G1/4	61	26	6,5	25,5	22	17	C0B700428
4	G3/8	62	28	6,5	26	22	21	C0B700438
4	G1/2	69,5	30,5	8	29,5	24	24	C0B700448
6	G1/8	50	25	5	20,5	18	14	C0B700618
6	G1/4	61	27	6,5	25,5	22	17	C0B700628
6	G3/8	62	28,5	6,5	26	22	21	C0B700638
6	G1/2	69,5	31	8	29,5	24	24	C0B700648
8	G1/8	50	27	5	20,5	18	14	C0B700818
8	G1/4	61	30,5	6,5	25,5	22	17	C0B700828
8	G3/8	62	30,5	6,5	26	22	21	C0B700838
8	G1/2	69,5	32,5	8	29,5	24	24	C0B700848
10	G1/8	50	28,5	5	20,5	18	14	C0B701018
10	G1/4	61	30,5	6,5	25,5	22	17	C0B701028
10	G3/8	62	32,5	6,5	26	22	21	C0B701038
10	G1/2	69,5	35	8	29,5	24	24	C0B701048
12	G1/4	61	34	6,5	25,5	22	17	C0B701228
12	G3/8	62	35	6,5	26	22	21	C0B701238
12	G1/2	69,5	39	8	29,5	24	24	C0B701248

**Drosselückschlagventil (Abluft),
kegeliges Gewinde
C0TA0**

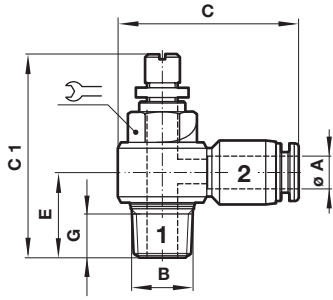

Ø A	B	C	> C1	< C1	E	G		Typ
4	R1/8	30,5	35	40	14,5	8	11	C0TA00418
4	R1/4	34,5	40	45,5	18	10	15	C0TA00428
6	R1/8	31	35	31	14,5	8	11	C0TA00618
6	R1/4	35	40	45,5	18	10	15	C0TA00628
6	R3/8	38,5	46,5	55	21	11	19	C0TA00638
8	R1/8	33	35	40	15,5	8	11	C0TA00818
8	R1/4	37	40	45,5	19	10	15	C0TA00828
8	R3/8	40	46,5	55	21	11	19	C0TA00838
8	R1/2	46	53	60	25	14	24	C0TA00848
10	R1/4	39	40	45,5	20	10	15	C0TA01028
10	R3/8	42	46,5	55	22,5	11	19	C0TA01038
10	R1/2	47,5	53	60	25	14	24	C0TA01048
12	R1/4	41	40	45,5	22	10	15	C0TA01228
12	R3/8	46	46,5	55	23	11	19	C0TA01238
12	R1/2	50	53	60	27	14	24	C0TA01248

**Drosselückschlagventil (Abluft)
zylindrisches Gewinde
C0K51**

Abmessungen in mm
Projection/First angle

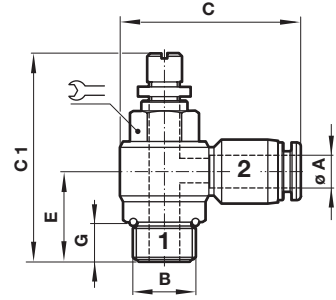

Ø A	B	C	> C1	< C1	E	G		Typ
3	M5	21,5	27	30	9,5	3,5	8	C0K510305
4	M5	25	27	30	10	3,5	8	C0K510405
4	G1/8	30,5	35	40	15	6	8	C0K510418
4	G1/4	34,5	40	45,5	17	8	12	C0K510428
6	M5	28	27	30	11	3,5	8	C0K510605
6	G1/8	31	35	40	15	6	8	C0K510618
6	G1/4	35	40	45,5	17	8	12	C0K510628
6	G3/8	38,5	46,5	55	21	8	14	C0K510638
8	G1/8	33	35	40	14	6	8	C0K510818
8	G1/4	37	40	45,5	16	8	12	C0K510828
8	G3/8	40	46,5	55	21	8	14	C0K510838
8	G1/2	46	53	60	22,5	9	17	C0K510848
10	G1/4	39	40	45,5	18	8	12	C0K511028
10	G3/8	42	46,5	55	19,5	8	14	C0K511038
10	G1/2	47,5	53	60	22,5	9	17	C0K511048
12	G1/4	41	40	45,5	20	8	12	C0K511228
12	G3/8	46	46,5	55	19	8	14	C0K511238
12	G1/2	50	53	60	21	9	17	C0K511248

**Schwenkverschraubung, 6-fach
kegeliges Gewinde
C0H70**

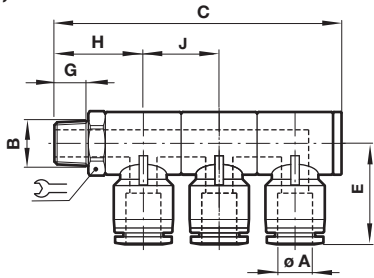

Ø A	B	C	E	G	H	J		Typ
4	R1/8	52	24	8	22,5	18	14	C0H700418
4	R1/4	63	26	10	27,5	22	17	C0H700428
4	R3/8	65	28	11	29	22	21	C0H700438
4	R1/2	74	30,5	14	34	24	24	C0H700448
6	R1/8	52	25	8	22,5	18	14	C0H700618
6	R1/4	63	27	10	27,5	22	17	C0H700628
6	R3/8	65	28,5	11	29	22	21	C0H700638
6	R1/2	74	31	14	34	24	24	C0H700648
8	R1/8	52	27	8	22,5	18	14	C0H700818
8	R1/4	63	30,5	10	27,5	22	17	C0H700828
8	R3/8	65	30,5	11	29	22	21	C0H700838
8	R1/2	74	32,5	14	34	24	24	C0H700848
10	R1/8	52	28,5	8	22,5	18	14	C0H701018
10	R1/4	63	30,5	10	27,5	22	17	C0H701028
10	R3/8	65	32,5	11	29	22	21	C0H701038
10	R1/2	74	35	14	34	24	24	C0H701048
12	R1/4	63	34	10	27,5	22	17	C0H701228
12	R3/8	65	35	11	29	22	21	C0H701238
12	R1/2	74	39	14	34	24	24	C0H701248

**Schwenkverschraubung, 6-fach
zylindrisches Gewinde
C0C70**

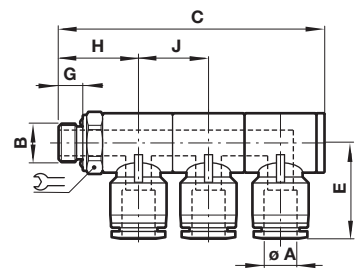

Ø A	B	C	E	G	H	J		Typ
4	G1/8	68	24	5	20,5	18	14	C0C700418
4	G1/4	83	26	6,5	25,5	22	17	C0C700428
4	G3/8	84	28	6,5	26	22	21	C0C700438
4	G1/2	93	30,5	8	29,5	24	24	C0C700448
6	G1/8	68	25	5	20,5	18	14	C0C700618
6	G1/4	83	27	6,5	25,5	22	17	C0C700628
6	G3/8	84	28,5	6,5	26	22	21	C0C700638
6	G1/2	93	31	8	29,5	24	24	C0C700648
8	G1/8	68	27	5	20,5	18	14	C0C700818
8	G1/4	83	30,5	6,5	25,5	22	17	C0C700828
8	G3/8	84	30,5	6,5	26	22	21	C0C700838
8	G1/2	93	32,5	8	29,5	24	24	C0C700848
10	G1/8	68	28,5	5	20,5	18	14	C0C701018
10	G1/4	83	30,5	6,5	25,5	22	17	C0C701028
10	G3/8	84	32,5	6,5	26	22	21	C0C701038
10	G1/2	93	35	8	29,5	24	24	C0C701048
12	G1/4	83	34	6,5	25,5	22	17	C0C701228
12	G3/8	84	35	6,5	26	22	21	C0C701238
12	G1/2	93	39	8	29,5	24	24	C0C701248

**Drosselrückschlagventil (Zuluft),
kegeliges Gewinde
C0SA0**

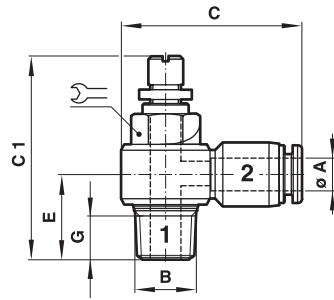

Ø A	B	C	C1 min.	C1 max.	E	G	Symbol	Typ
4	R1/8	30,5	35	40	14,5	8	11	C0SA00418
4	R1/4	34,5	40	45,5	18	10	15	C0SA00428
6	R1/8	31	35	40	14,5	8	11	C0SA00618
6	R1/4	35	40	45,5	18	10	15	C0SA00628
6	R3/8	39	46,5	55	21	11	19	C0SA00638
8	R1/8	33	35	40	15,5	8	11	C0SA00818
8	R1/4	37	40	45,5	19	10	15	C0SA00828
8	R3/8	40	46,5	55	21	11	19	C0SA00838
8	R1/2	46	53	60	25	14	24	C0SA00848
10	R1/4	39	40	45,5	20	10	15	C0SA01028
10	R3/8	42	46,5	55	22,5	11	19	C0SA01038
10	R1/2	47,5	53	60	25	14	24	C0SA01048
12	R1/4	41	40	45,5	22	10	15	C0SA01228
12	R3/8	46	46,5	55	23	11	19	C0SA01238
12	R1/2	50	53	60	27	14	24	C0SA01248

**Drosselrückschlagventil (Abluft), Einstellschraube
versenkt, kegeliges Gewinde
C0TB0**

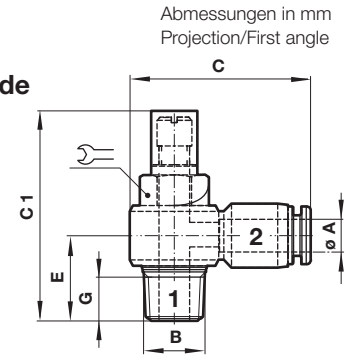

Ø A	B	C	C1	E	G	Symbol	Typ
4	R1/8	30,5	31,5	15	8	11	C0TB00418
4	R1/4	34,5	37	18,5	10	15	C0TB00428
6	R1/8	31	31,5	15	8	11	C0TB00618
6	R1/4	35	37	18,5	10	15	C0TB00628
6	R3/8	38,5	43,5	22	11	19	C0TB00638
8	R1/8	33	31,5	16,5	8	11	C0TB00818
8	R1/4	37	37	19,5	10	15	C0TB00828
8	R3/8	40	43,5	22	11	19	C0TB00838
8	R1/2	46	50	26,5	14	24	C0TB00848
10	R1/4	39	37	21	10	15	C0TB01028
10	R3/8	42	43,5	23,5	11	19	C0TB01038
10	R1/2	47,5	50	26,5	14	24	C0TB01048
12	R1/4	41	37	22,5	10	15	C0TB01228
12	R3/8	46	43,5	24	11	19	C0TB01238
12	R1/2	50	50	28	14	24	C0TB01248

**Drosselrückschlagventil (Zuluft)
zylindrisches Gewinde
C0L51**

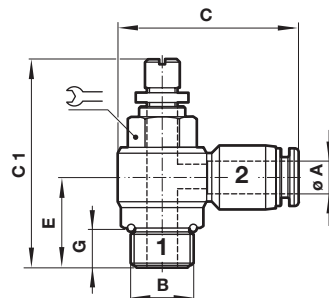

Ø A	B	C	> C1	< C1	E	G	Symbol	Typ
3	M5	21,5	27	30	9,5	3,5	8	C0L510305
4	M5	25	27	30	10	3,5	8	C0L510405
4	G1/8	30,5	35	40	15	6	8	C0L510418
4	G1/4	34,5	40	45,5	17	8	12	C0L510428
6	M5	28	27	30	11	3,5	8	C0L510605
6	G1/8	31	35	40	15	6	8	C0L510618
6	G1/4	35	40	45,5	17	8	12	C0L510628
6	G3/8	39	46,5	55	21	8	14	C0L510638
8	G1/8	33	35	40	14	6	8	C0L510818
8	G1/4	37	40	45,5	16	8	12	C0L510828
8	G3/8	40	46,5	55	21	8	14	C0L510838
8	G1/2	46	53	60	22,5	9	17	C0L510848
10	G1/4	39	40	45,5	18	8	12	C0L511028
10	G3/8	42	46,5	55	19,5	8	14	C0L511038
10	G1/2	47,5	53	60	22,5	9	17	C0L511048
12	G1/4	41	40	45,5	20	8	12	C0L511228
12	G3/8	46	46,5	55	19	8	14	C0L511238
12	G1/2	50	53	60	21	9	17	C0L511248

**Drosselrückschlagventil (Abluft)
zylindrisches Gewinde
C0KB0**

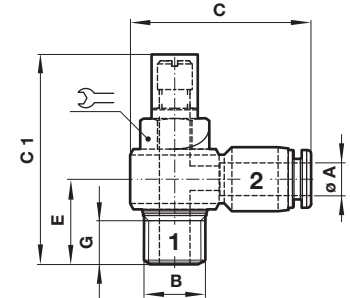

Ø A	B	C	C1	E	G	Symbol	Typ
4	M5	25	23	10,5	3,5	8	C0KB00405
4	G1/8	30,5	31,5	15	6	8	C0KB00418
4	G1/4	34,5	37	17,5	8	12	C0KB00428
6	M5	28	23	11,5	3,5	8	C0KB00605
6	G1/8	31	31,5	15	6	8	C0KB00618
6	G1/4	35	37	17,5	8	12	C0KB00628
6	G3/8	38,5	43,5	21	8	14	C0KB00638
8	G1/8	33	31,5	14	6	8	C0KB00818
8	G1/4	37	37	17	8	12	C0KB00828
8	G3/8	40	43,5	21	8	14	C0KB00838
8	G1/2	46	50	23	9	17	C0KB00848
10	G1/4	39	37	19	8	12	C0KB01028
10	G3/8	42	43,5	20	8	14	C0KB01038
10	G1/2	47,5	50	23	9	17	C0KB01048
12	G1/4	41	37	20,5	8	12	C0KB01228
12	G3/8	46	43,5	19	8	14	C0KB01238
12	G1/2	50	50	21,5	9	17	C0KB01248

Drosselückschlagventil (Abluft)
 kegeliges Gewinde
 C0T56

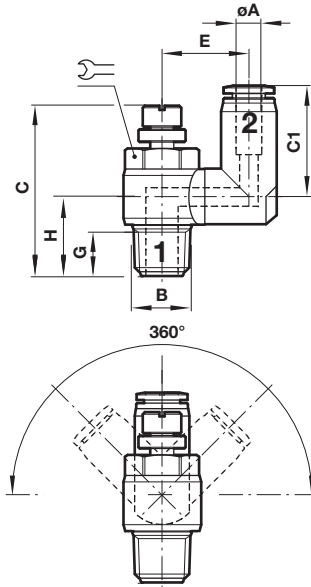

Drosselückschlagventil (Abluft)
 zylindrisches Gewinde
 C0K56

Abmessungen in mm
 Projection/First angle

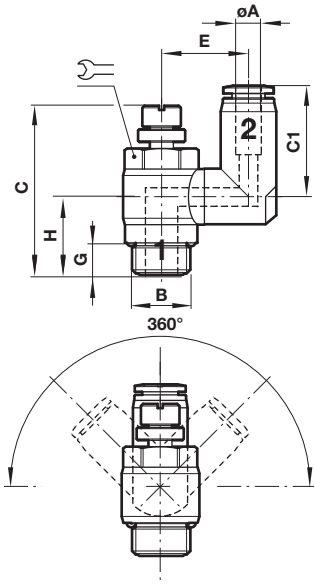

Ø A	B	C*1)	C1	E	G	H		Typ
4	R1/8	35/40	20,5	14,5	8	15	11	C0T560418
4	R1/4	40/45,5	20,5	18	10	18,5	15	C0T560428
6	R1/8	35/40	24	15,5	8	15	11	C0T560618
6	R1/4	40/45,5	26	20,5	10	18,5	15	C0T560628
6	R3/8	47/55	26	23,5	11	21,5	19	C0T560638
8	R1/8	35/40	25,5	16	8	15,5	11	C0T560818
8	R1/4	40/45,5	29	19,5	10	18,5	15	C0T560828
8	R3/8	47/55	30	24,5	11	22	19	C0T560838
8	R1/2	53/60	30	26,5	14	26	24	C0T560848
10	R1/4	40/45,5	31	20,5	10	18,5	15	C0T561028
10	R3/8	47/55	32	24,5	11	22	19	C0T561038
10	R1/2	53/60	33	26,5	14	26,5	24	C0T561048
12	R1/4	40/45,5	33,5	22	10	18,5	15	C0T561228
12	R3/8	47/55	34,5	24,5	11	22	19	C0T561238
12	R1/2	53/60	36	26,5	14	26,5	24	C0T561248

* min/max

Ø A	B	C*1)	C1	E	G	H		Typ
4	M5	27/30	20,5	12,5	3,6	9,5	8	C0K560405
4	G1/8	35/40	20,5	14,5	8	15,5	8	C0K560418
4	G1/4	40/45,5	20,5	18	12	17,5	12	C0K560428
6	M5	27/30	22,5	13,5	3,6	9,5	8	C0K560605
6	G1/8	35/40	24	15,5	8	15,5	8	C0K560618
6	G1/4	40/45,5	26	20,5	12	17,5	12	C0K560628
6	G3/8	47/55	26	23,5	14	21,5	14	C0K560638
8	G1/8	35/40	25,5	16	8	14,5	8	C0K560818
8	G1/4	40/45,5	29	19,5	12	17,5	12	C0K560828
8	G3/8	47/55	30	24,5	14	21	14	C0K560838
8	G1/2	53/60	30	26,5	17	23	17	C0K560848
10	G1/4	40/45,5	31	20,5	12	17,5	12	C0K561028
10	G3/8	47/55	32	24,5	14	21	14	C0K561038
10	G1/2	53/60	33	26,5	17	23	17	C0K561048
12	G1/4	40/45,5	33,5	22	12	17,5	12	C0K561228
12	G3/8	47/55	34,5	24,5	14	21	14	C0K561238
12	G1/2	53/60	36	26,5	17	23	17	C0K561248

* min/max

**Drosselückschlag-mit Stoppventil
kegeliges Gewinde
C01GN**

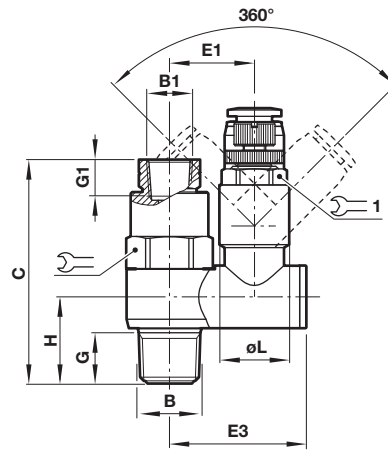
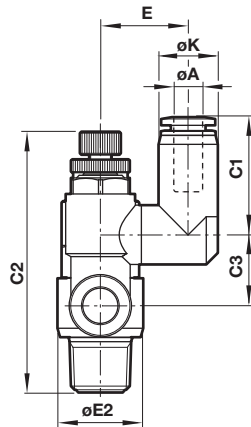
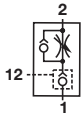

Abmessungen in mm
Projection/First angle



Achtung:
Dies ist keine Rotationsverschraubung.
Durch Rotation könnte der Grundkörper erhitzen und einen Brand verursachen.

Ø A	B	B1	C	C1	C2*1)	C3	E	E1	Ø E2	E3	G	G1	H	Ø K	Ø L	↺	↺1	Typ
6	R1/8	M5	41	24	50,6/55,4	12,9	14,2	14,3	15	24,2	16	8,5	16	12,5	12	12	10	C01GN0618
6	R1/4	R1/8	49,1	25,9	57,1/61,9	15,6	19,3	18,7	18,8	30,1	11	10	19	13	15,3	17	13	C01GN0628
8	R1/8	M5	41	24,9	50,6/55,4	12,6	15,4	14,3	15	24,2	8,5	8,5	16	14,8	12	12	10	C01GN0818
8	R1/4	R1/8	49,1	28,3	57,1/61,9	15,9	18,3	18,7	18,8	30,1	11	10	19	14,8	15,3	17	13	C01GN0828
8	R3/8	R1/8	56,9	29,3	67,2/72,2	19,1	23,3	22,8	23	37,1	12	10	22,5	15	20,2	19	17	C01GN0838
10	R3/8	R1/8	56,9	31,7	67,2/72,2	19,1	23,3	22,8	23	37,1	12	10	22,5	17,5	20,2	19	17	C01GN1038
10	R1/2	R1/4	70,8	33,1	81,3/87	25,6	26,3	29,1	28,7	47,4	15	13,5	28	17,5	27,2	24	23	C01GN1048
12	R3/8	R1/8	56,9	34,4	67,2/72,2	19,1	23,3	22,8	23	37,1	12	10	22,5	20,5	20,2	19	17	C01GN1238
12	R1/2	R1/4	70,8	35,8	81,3/87	25,6	26,3	29,1	28,7	47,4	15	13,5	28	20,5	27,2	24	23	C01GN1248

*1) min./max. Durchflussdiagramm, siehe Seite 6

**Drosselückschlag-mit Stoppventil
zylindrisches Gewinde
C02GN**

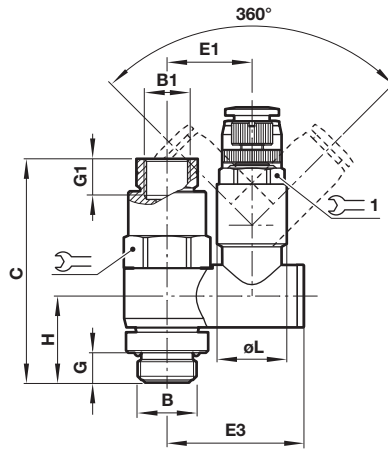
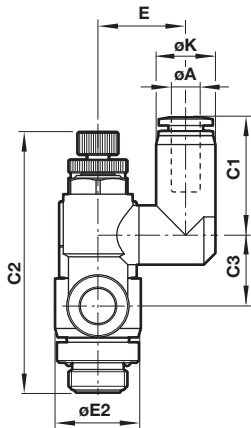
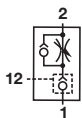

Achtung:
Dies ist keine Rotationsverschraubung.
Durch Rotation könnte der Grundkörper erhitzen und einen Brand verursachen.

Ø A	B	B1	C	C1	C2*1)	C3	E	E1	Ø E2	E3	G	G1	H	Ø K	Ø L	↺	↺1	Typ
6	G1/8	M5	41	24	50,6/55,4	12,9	14,2	14,3	15	24,2	5	8,5	16	12,5	12	12	10	C02GN0618
6	G1/4	G1/8	49,1	25,9	57,1/61,9	15,6	19,3	18,7	18,8	30,1	6,5	9,5	19	13	15,3	17	13	C02GN0628
8	G1/8	M5	41	24,9	50,6/55,4	12,6	15,4	14,3	15	24,2	5	8,5	16	14,8	12	12	10	C02GN0818
8	G1/4	G1/8	49,1	28,3	57,1/61,9	15,9	18,3	18,7	18,8	30,1	6,5	9,5	19	14,8	15,3	17	13	C02GN0828
8	G3/8	G1/8	56,9	29,3	67,2/72,2	19,1	23,3	22,8	23	37,1	7	9,5	22,5	15	20,2	19	17	C02GN0838
10	G3/8	G1/8	56,9	31,7	67,2/72,2	19,1	23,3	22,8	23	37,1	7	9,5	22,5	17,5	20,2	19	17	C02GN1038
10	G1/2	G1/4	70,8	33,1	81,3/78,5	25,6	26,3	29,1	28,7	47,4	8,5	13	28	17,5	27,2	24	23	C02GN1048
12	G3/8	G1/8	56,9	34,4	67,2/72,2	19,1	23,3	22,8	23	37,1	7	9,5	22,5	20,5	20,2	19	17	C02GN1238
12	G1/2	G1/4	70,8	35,8	81,3/78,5	25,6	26,3	29,1	28,7	47,4	8,5	13	28	20,5	27,2	24	23	C02GN1248

*1) min./max. Durchflussdiagramm, siehe Seite 6

**Drosselrückschlagventile (Leitungsmontage)
 C00GE**

Abmessungen in mm
 Projection/First angle

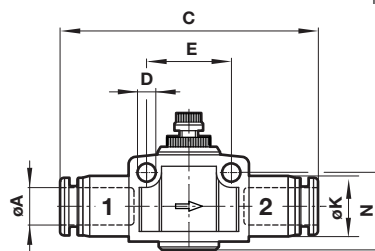
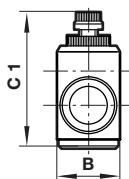

Ø A	B	C	> C1	< C1	D	E	Ø K	N	Typ
4	12	45	30	33	3,3	15	11	13,5	C00GE0400
6	16	50	35	39,5	4,4	20,5	13	17,5	C00GE0600
8	19	55,5	37,5	42	4,4	23	15	20	C00GE0800
10	23	61	44	49	4,4	28	17,5	23	C00GE1000
12	26,5	70	47,5	53,5	4,4	32	20,5	25,5	C00GE1200

Durchflussdiagramm, siehe Seite 5

**Drosselrückschlagventile (Leitungs- und Paneelmontage)
 C00GP**

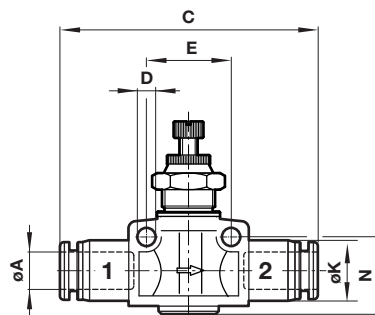
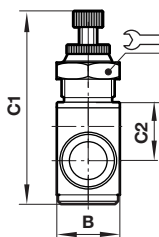

Ø A	B	C	> C1	< C1	C2	D	E	Ø K	N		Panel	Panelstärke	Typ
4	12	42	35,5	38	5,5	3,2	15,5	11	13,5	12	11	5	C00GP0400
6	16	49,5	43	48,5	8	4,3	20,5	13	17,5	17	15	6	C00GP0600
8	19	56,5	47,5	53	8,5	4,3	23	15	20	19	17	6	C00GP0800
10	23	63	53,5	61,5	10,5	4,3	27,5	17,5	23	22	17	7	C00GP1000
12	26,5	73,5	57,5	64,5	12	4,4	32,5	20,5	25,5	24	21	7	C00GP1200

Durchflussdiagramm, siehe Seite 5

**Rückschlagventil (PBT)
C00GL**

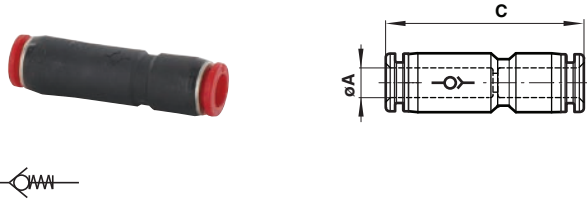

$\varnothing A$	C	Typ
4	42	C00GL0400
6	47,5	C00GL0600
8	55,5	C00GL0800

**Rückschlagventil (Aluminium)
C00GL**

Abmessungen in mm
Projection/First angle

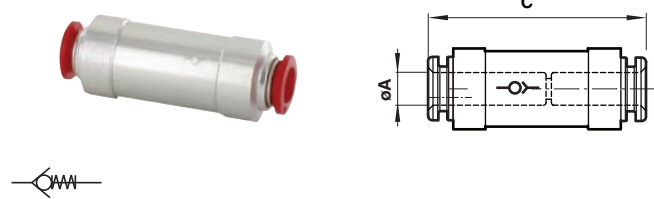

$\varnothing A$	C	Typ
10	65	C00GL1000
12	73	C00GL1200

**Rückschlagventil (Zuluft), kegeliges Gewinde
C01G2**

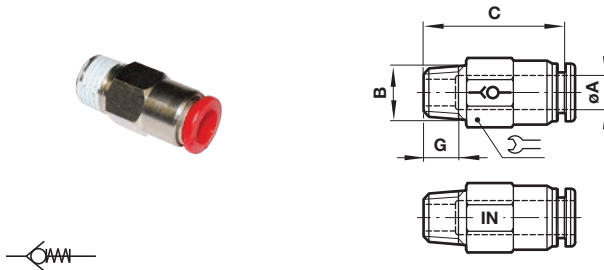

$\varnothing A$	B	C	G		Typ
4	R1/8	27,5	8	10	C01G20418
6	R1/8	32,5	8	12	C01G20618
8	R1/4	37,5	10	14	C01G20828

**Rückschlagventil (Abluft), kegeliges Gewinde
C01G3**

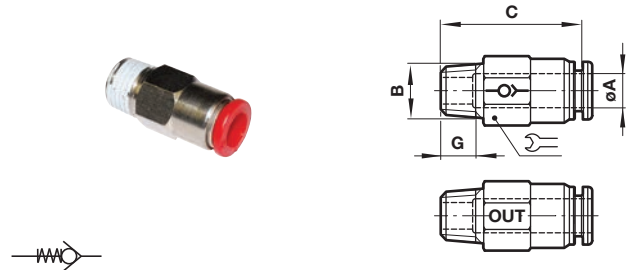

$\varnothing A$	B	C	G		Gewicht (g)	Typ
4	R1/8	27,5	8	10	11	C01G30418
6	R1/8	32,5	8	12	16	C01G30618
8	R1/4	37,5	10	14	24	C01G30828

**Rückschlagventil (Zuluft), ISO G
zylindrisches Gewinde
C02G2**

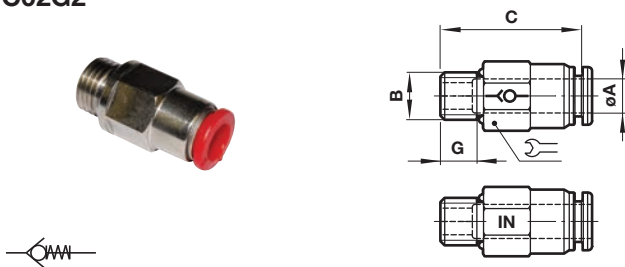

$\varnothing A$	B	C	G		Typ
4	M5	31,5	3,5	10	C02G20405
4	G1/8	27,5	6	10	C02G20418
6	G1/8	32,5	6	12	C02G20618
8	G1/4	37	7	15	C02G20828
10	G3/8	54	8	22	C02G21038
12	G1/2	60,5	9	24	C02G21248

**Rückschlagventil (Abluft), ISO G
zylindrisches Gewinde
C02G3**

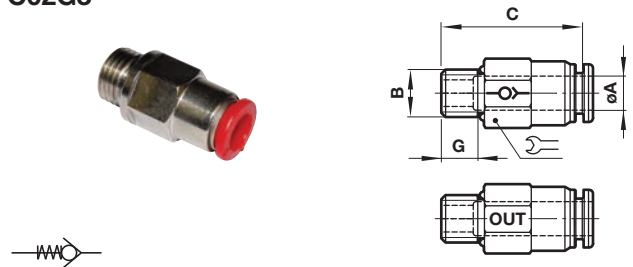

$\varnothing A$	B	C	G		Typ
4	M5	31,5	3,5	10	C02G30405
4	G1/8	27,5	6	10	C02G30418
6	G1/8	32,5	6	12	C02G30618
8	G1/4	37	7	15	C02G30828
10	G3/8	54	8	22	C02G31038
12	G1/2	60,5	9	24	C02G31248

**Absperrende
Verschraubungen**

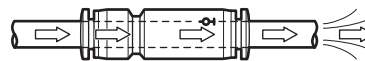
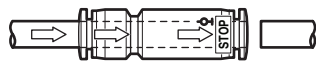

Abmessungen in mm
Projection/First angle



Beim Lösen des Schlauches wird der Durchgang gesperrt

**Gerade Einschraubverschraubung absperrend
kegeliges Gewinde
C0124**

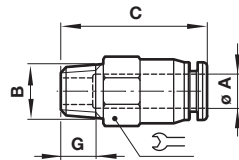

Ø A	B	C	G		Typ
4	R1/8	26	8	10	C01240418
6	R1/8	29	8	12	C01240618
6	R1/4	29	10	14	C01240628
8	R1/4	33,5	10	14	C01240828
8	R3/8	33,5	11	17	C01240838
10	R1/4	35,5	10	17	C01241028
10	R3/8	35,5	11	17	C01241038
10	R1/2	35,5	14	21	C01241048
12	R1/4	42	10	19	C01241228
12	R3/8	42	11	19	C01241238
12	R1/2	42	14	21	C01241248

**Winkelverschraubung absperrend
kegeliges Gewinde
C014J**

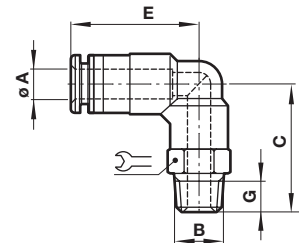

Ø A	B	C	E	G		Typ
4	R1/8	27	27,5	5	10	C014J0418
6	R1/8	30	32	5	12	C014J0618
6	R1/4	32	30,5	6,5	14	C014J0628
8	R1/8	34,5	41,5	6,5	14	C014J0818
8	R1/4	34	40	6,5	17	C014J0828
10	R1/4	32	26,5	6,5	17	C014J1028
10	R3/8	36	45	6,5	17	C014J1038
10	R1/2	37,5	43	8	21	C014J1048
12	R3/8	40	53,5	6,5	19	C014J1238
12	R1/2	41,5	51,5	8	21	C014J1248

**Gerade Einschraubverschraubung absperrend
zylindrisches Gewinde
C0224**

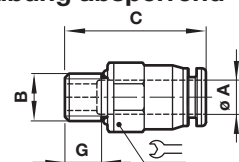

Ø A	B	C	G		Typ
4	G1/8	25,5	5	12	C02240418
6	G1/8	28	5	12	C02240618
6	G1/4	27	6,5	15	C02240628
8	G1/4	32	6,5	15	C02240828
8	G3/8	32	6,5	17	C02240838
10	G1/4	35	6,5	17	C02241028
10	G3/8	36,5	6,5	17	C02241038
10	G1/2	37,5	8	21	C02241048
12	G1/4	43,5	6,5	19	C02241228
12	G3/8	43,5	6,5	21	C02241238
12	G1/2	44	8	21	C02241248

**Winkelverschraubung absperrend
zylindrisches Gewinde
C024J**

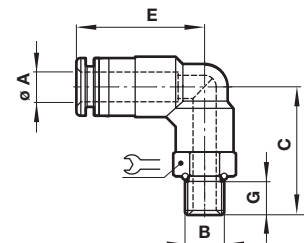

Ø A	B	C	E	G		Typ
4	M5	20,5	29,5	4	10	C024J0405
4	G1/8	27	27,5	5	14	C024J0418
6	M5	22,5	33	4	12	C024J0605
6	G1/8	30	32	5	14	C024J0618
6	G1/4	32	30,5	6,5	14	C024J0628
8	G1/4	34,5	41,5	6,5	17	C024J0828
8	G3/8	34	40	6,5	20	C024J0838
10	G1/4	32	26,5	6,5	17	C024J1028
10	G3/8	36	45	6,5	20	C024J1038
10	G1/2	37,5	43	8	24	C024J1048
12	G3/8	40	53,5	6,5	20	C024J1238
12	G1/2	41,5	51,5	8	24	C024J1248

**Gerade Verbindung absperrend
C002J**

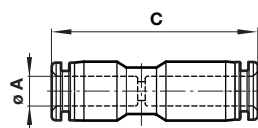

Ø A	C	Typ
4	42	C002J0400
6	46	C002J0600
8	53,5	C002J0800
10	58	C002J1000
12	67	C002J1200

3/2 Absperrventil kegeliges Gewinde C01GG

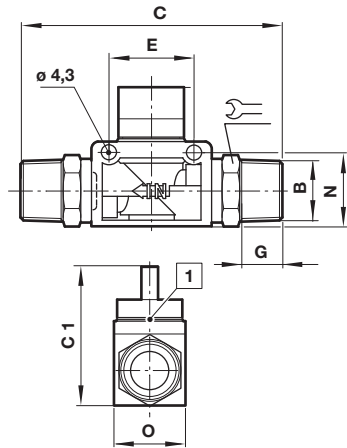

1 Entlüftungsbohrung

B	C	C1	E	G	N	O	Ø	Typ
R1/8	71	40,5	19	8	18,5	18	14	C01GG1818
R1/4	77	40,5	19	10	18,5	18	14	C01GG2828
R3/8	81	41	24	11	21,5	21	17	C01GG3838
R1/2	90	41	24	14	21,5	21	21	C01GG4848

3/2 Absperrventil kegeliges Gewinde C01GH

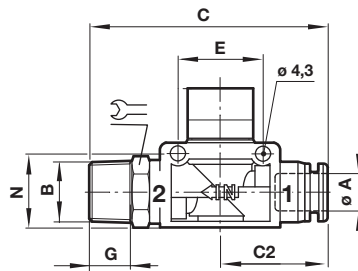

ØA	B	C	C1 *	C2	E	G	N	O *	Ø	Typ
6	R1/8	62	40,5	26	19	8	18,5	18	14	C01GH0618
6	R1/4	65	40,5	26	19	10	18,5	18	14	C01GH0628
6	R3/8	66	40,5	26	19	11	18,5	21	17	C01GH0638
8	R1/8	63	40,5	27,5	19	8	18,5	18	14	C01GH0818
8	R1/4	66	40,5	27,5	19	10	18,5	18	14	C01GH0828
8	R3/8	67	40,5	27,5	19	11	18,5	21	17	C01GH0838
10	R1/4	67	41	31	24	10	21,5	18	17	C01GH1028
10	R3/8	71,5	41	31	24	11	21,5	21	17	C01GH1038
10	R1/2	74,5	41	31	24	14	21,5	21	21	C01GH1048
12	R1/4	75,5	41	34	24	10	21,5	18	19	C01GH1228
12	R3/8	76,5	41	34	24	11	21,5	21	19	C01GH1238
12	R1/2	79,5	41	34	24	14	21,5	21	21	C01GH1248

* Siehe Zeichnung Serie C01GG

3/2 Absperrventil kegeliges Gewinde C01GJ



Abmessungen in mm
Projection/First angle

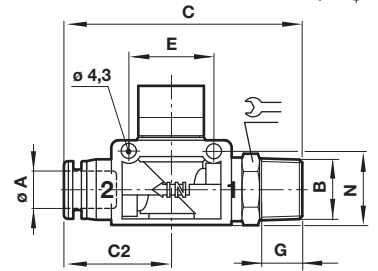

ØA	B	C	C1 *	C2	E	G	N	O *	Ø	Typ
6	R1/8	62	40,5	26	19	8	18,5	18	14	C01GJ0618
6	R1/4	65	40,5	26	19	10	18,5	18	14	C01GJ0628
6	R3/8	66	40,5	26	19	11	18,5	21	17	C01GJ0638
8	R1/8	65	40,5	27,5	19	8	18,5	18	14	C01GJ0818
8	R1/4	66	40,5	27,5	19	10	18,5	18	14	C01GJ0828
8	R3/8	67	40,5	27,5	19	11	18,5	21	17	C01GJ0838
10	R1/4	70,5	41	31	24	10	21,5	18	17	C01GJ1028
10	R3/8	71,5	41	31	24	11	21,5	21	17	C01GJ1038
10	R1/2	74,5	41	31	24	14	21,5	21	21	C01GJ1048
12	R1/4	75,5	41	34	24	10	21,5	18	19	C01GJ1228
12	R3/8	76,5	41	34	24	11	21,5	21	19	C01GJ1238
12	R1/2	79,5	41	34	24	14	21,5	21	21	C01GJ1248

* Siehe Zeichnung Serie C01GG

3/2 Absperrventil C01GF

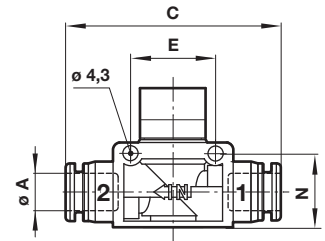

ØA	C	C1 *	E	N	O *	Typ
6	52,5	40,5	19	18,5	18	C00GF0600
8	53	40,5	19	18,5	18	C00GF0800
10	62	41	24	21,5	21	C00GF1000
12	68,5	41	24	21,5	21	C00GF1200

* Siehe Zeichnung Serie C01GG

Sicherheitshinweise

Diese Produkte sind ausschließlich in Druckluftsystemen zu verwenden. Sie sind dort einzusetzen, wo die unter »Technische Merkmale/-Daten« aufgeführten Werte nicht überschritten werden. Berücksichtigen Sie bitte die entsprechende Katalogseite. Vor dem Einsatz der Produkte bei nicht industriellen Anwendungen, in lebenserhaltenden- oder anderen Systemen, die nicht in den veröffentlichten Anleitungsunterlagen enthalten sind, wenden Sie sich bitte direkt an IMI NORGREN. Durch Missbrauch, Verschleiß oder Störungen können in Pneumatik-

systemen verwendete Komponenten auf verschiedene Arten versagen. Systemauslegern wird dringend empfohlen, die Störungsarten aller in Pneumatiksystemen verwendeten Komponententeile zu berücksichtigen und ausreichende Sicherheitsvorkehrungen zu treffen, um Verletzungen von Personen sowie Beschädigungen der Geräte im Falle einer solchen Störung zu verhindern. Systemausleger sind verpflichtet, Sicherheitshinweise für den Endbenutzer im Betriebshandbuch zu vermerken, wenn der Störungschutz nicht ausreichend gewährleistet ist.