

**PLEASE CHECK WWW.MOLEX.COM FOR LATEST PART INFORMATION**

**Part Number:** [0039532144](#)  
**Status:** **Active**  
**Overview:** FFC-FPC (Through-Hole)  
**Description:** 1.25mm Pitch Easy-On FFC/FPC Connector, Through-Hole, Right-Angle, ZIF, Top Contact Style, 14 Circuits

**Documents:**

[3D Model](#) [Packaging Specification SPK-5597-003-001 \(PDF\)](#)  
[Drawing \(PDF\)](#) [RoHS Certificate of Compliance \(PDF\)](#)  
[Product Specification PS-5597-004-001 \(PDF\)](#)

**Agency Certification**

UL E29179

**General**

Product Family FFC/FPC Connectors  
 Series [5597](#)  
 Overview [FFC-FPC \(Through-Hole\)](#)  
 Product Name Easy-On  
 UPC 822348170210

**Physical**

Actuator Type Slider  
 Circuits (Loaded) 14  
 Circuits (maximum) 14  
 Color - Resin Natural  
 Contact Position Top  
 Durability (mating cycles max) 30  
 Flammability 94V-0  
 Mated Height 5.00mm  
 Material - Metal Phosphor Bronze  
 Material - Plating Mating Tin-Bismuth  
 Material - Plating Termination Tin-Bismuth  
 Material - Resin Polyester  
 Net Weight 1255.930/mg  
 Number of Rows 1  
 Orientation Right Angle  
 PC Tail Length 3.50mm  
 PCB Locator No  
 PCB Mounting Through Hole  
 PCB Retention None  
 Packaging Type Tray  
 Pitch - Mating Interface 1.25mm  
 Plating min - Mating 1.016µm  
 Plating min - Termination 1.016µm  
 Polarized to PCB No  
 Stackable No  
 Surface Mount Compatible (SMC) No  
 Temperature Range - Operating -20° to +80°C  
 Wire/Cable Type FFC/FPC

**Electrical**

Current - Maximum per Contact 1.0A  
 Voltage - Maximum 200V

**Material Info**

Engineering Number 5597-14APB7F

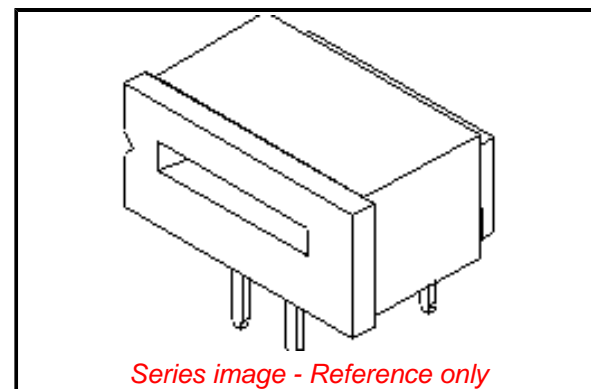

*Series image - Reference only*

**EU ELV**

**Not Relevant**

**EU RoHS**

**Compliant**

**REACH SVHC**

Not Contained Per -  
 ED/61/2018 (27 June  
 2018)

**Halogen-Free**

**Status**

**Not Low-Halogen**

For more information, please visit [Contact US](#)

China ROHS

ELV

RoHS Phthalates

**China RoHS**

Green Image

Not Relevant

Not Contained

**Search Parts in this Series**

[5597 Series](#)

**Reference - Drawing Numbers**

Packaging Specification

Product Specification

Sales Drawing

SPK-5597-003-001

PS-5597-004-001

SD-5597-011

This document was generated on 10/10/2018

**PLEASE CHECK [WWW.MOLEX.COM](http://WWW.MOLEX.COM) FOR LATEST PART INFORMATION**