

Customer Part:



Description

- Standard 2 x 1.6mm crystal oscillator in a hermetically sealed ceramic package with a seam sealed metal lid
- Model IQXO-540
- Model Issue number 3

Frequency Parameters

- Frequency 12.2880MHz
- Frequency Stability $\pm 25.00\text{ppm}$
- Operating Temperature Range -20.00 to 70.00°C
- Ageing $\pm 5\text{ppm}$ max per year @ 25°C

Electrical Parameters

- Supply Voltage $3.3\text{V} \pm 10\%$
- Current Draw 4.000mA

Output Details

- Output Compatibility CMOS
- Drive Capability 15pF max
- Rise and Fall Time 5.0ns max
- Duty Cycle $45/55\%$
- Start up time: 10ms max.
 0.7ms typ to 90% of final amplitude (under ideal conditions @ 25°C)

Output Control

- Standby Operation: Logic '1' ($\geq 70\%V_s$) to pad 1 enables oscillator output
Logic '0' ($\leq 30\%V_s$) to pad 1 disables oscillator output; when disabled the oscillator output goes to the high impedance state
No connection to pad 1 enables oscillator output
- Standby Current: $10\mu\text{A}$ max, $1.0\mu\text{A}$ typ @ 25°C

Output Levels

- Output High (VoH): 90% of V_s min
Output Low (VoL): 10% of V_s max

Environmental Parameters

- Storage Temperature Range: -40 to 85°C
- Impact: Weight of 10G dropped to centre of part from a height of 6mm
- Vibration: IEC 60068-2-6: 1.5mm amplitude, 10Hz-55Hz, 1min in 3 mutually perpendicular planes, duration 2hrs each plane (total 6hrs)

Manufacturing Details

- RoHS Terminations NiAu
- RoHS Reflow Temp 250°C max for 10s max

Compliance

- RoHS Status (2015/863/EU) Compliant
- REACH Status Compliant
- MSL Rating (JDEC-STD-033): Not Applicable

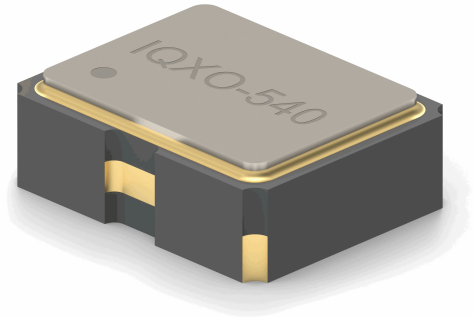

Outline (mm)

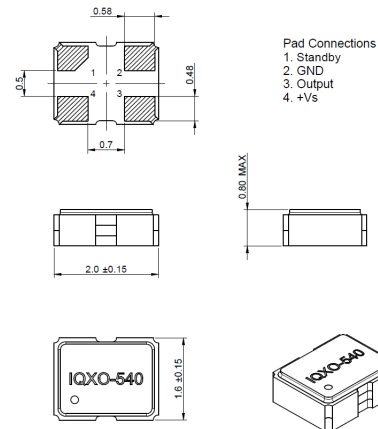

Test Circuit

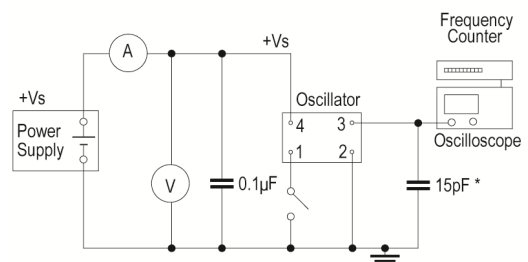

* Inclusive of jigging and equipment capacitance

Sales Office Contact Details:

UK: +44 (0)1460 270200

USA: +1.760 668 8935

Email: info@iqdfrequencyproducts.com

Web: www.iqdfrequencyproducts.com

Customer Part:

Packaging Details

- Tape & reel in accordance with EIA-481
Quantities below the standard reel size to be supplied on cut tape.
Standard Quantity: 3,000 Pieces

Test Circuit

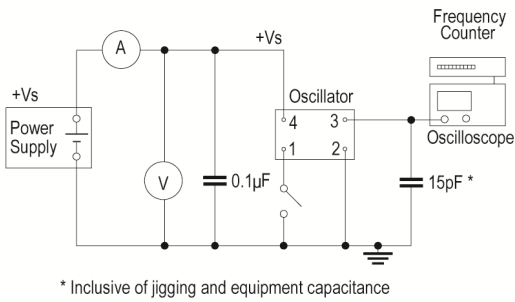

Wave Form

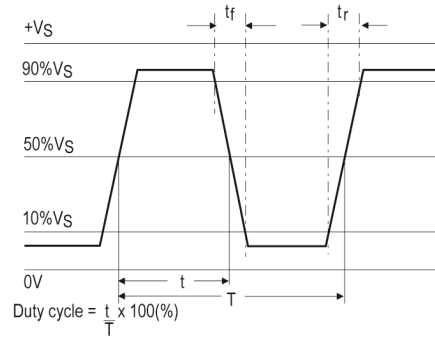

Sales Office Contact Details:

UK: +44 (0)1460 270200

USA: +1.760 668 8935

Email: info@iqdfrequencyproducts.com

Web: www.iqdfrequencyproducts.com