

## M12 male 0° / RJ45 male 0° shielded Ethernet

PUR 2x2xAWG22 shielded gn UL,CSA+dragch. 11m

Ethernet CAT 5, D-coded  
 Male straight to male straight  
 M12 - RJ45  
 4-pole, shielded

Further cable lengths on request. Plastic housings with good resistance against chemicals and oils. The resistance to aggressive media should be individually tested for your application. Further details on request.

### [Link to Product](#)

#### Illustration



Male



Male

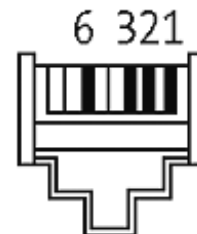

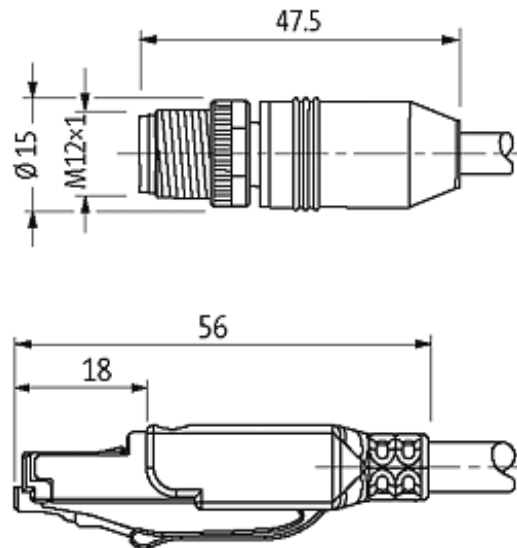

Product may differ from Image

### Approvals



### More Info



### Form

44711

### Technical Data

Operating voltage	60 V DC
Operating current per contact	max. 1.76 A
Transfer parameters	CAT5, class D (ISO/IEC 11801:2002), (EN 50173-1)
Transfer rate	10/100 Mbit/s full duplex
Locking of ports	Screw thread M12 × 1 mm (recommended torque 0.6 Nm) self-securing
Protection	IP67 (M12) - IP20 (RJ45)

### Cables

Cable number	796
No./diameter of wires	2 × 2 × AWG22
Wire isolation	PE (wh, ye, bl, or)
C-track properties	2 Mio.
Jacket Color	green
Shore hardness outer jacket	90 ± 5A

The information in this brochure has been compiled with the utmost care.

Liability for the correctness completeness and topicality of the information is restricted to gross negligence. Version: 05/15

Material (jacket)	PUR (UL/CSA)
Outer diameter	approx. 6.7 mm
Bend radius (fixed)	5 × outer Ø
Bend radius (moving)	15 × outer Ø
Temperature range (fixed)	-40...+80 °C
Temperature range (mobile)	-20...+60 °C
Shielded	yes

**Commercial data**

country of origin	DE
customs tariff number	85444210
minimum order quantity	1