

Click [here](#) for production status of specific part numbers.

## MAXM17623/MAXM17624

## 2.9V to 5.5V, 1A Himalaya uSLIC Step-Down Power Modules

### General Description

The Himalaya series of voltage regulator ICs and power modules enable cooler, smaller, and simpler power-supply solutions. MAXM17623 and MAXM17624 are high-frequency synchronous step down DC-DC converter modules, with integrated MOSFETs, compensation components, and inductors, that operate over 2.9V to 5.5V input voltage range. MAXM17623 and MAXM17624 support up to 1A load current and allow use of small, low-cost input and output capacitors. The output voltage can be adjusted from 0.8V to 3.3V. The modules significantly reduce design complexity, manufacturing risks, and offer a true plug-and-play power supply solution, reducing time-to-market.

The MAXM17623 and MAXM17624 modules employ peak-current-mode control architecture under steady-state operation. To reduce input inrush current, the devices offer a fixed 1ms soft-start time. Both modules feature selectable PWM or PFM mode of operation at light loads. When PWM mode is selected, MAXM17623 operates at a fixed 2MHz switching frequency and MAXM17624 operates at a fixed 4MHz switching frequency. MAXM17623 offers output voltages from 0.8V to 1.5V and MAXM17624 offers output voltages from 1.5V to 3.3V.

The MAXM17623 and MAXM17624 modules are available in a low profile, compact 10-pin, 2.6mm x 2.1mm x 1.3mm, uSLIC™ package.

### Applications

- Point of Load Power Supply
- Standard 5V Rail Supplies
- Battery Powered Applications
- Distributed Power Systems
- Industrial Sensors and Process Control

**Ordering Information** appears at end of data sheet.

### Benefits and Features

- Easy to Use
  - 2.9V to 5.5V Input
  - Adjustable 0.8V to 3.3V Output
  - $\pm 1\%$  Feedback Accuracy
  - Up to 1A Output Current
  - Fixed 2MHz or 4MHz Operation
  - 100% Duty-Cycle Operation
  - Internally Compensated
  - All Ceramic Capacitors
- High Efficiency
  - Selectable PWM- or PFM-Mode of Operation
  - Shutdown Current as Low as 0.1 $\mu$ A (typ)
- Flexible Design
  - Internal Soft-Start and Prebias Startup
  - Open-Drain Power Good Output (PGOOD Pin)
- Robust Operation
  - Overtemperature Protection
  - $-40^{\circ}\text{C}$  to  $+125^{\circ}\text{C}$  Ambient Operating Temperature/  
 $-40^{\circ}\text{C}$  to  $+150^{\circ}\text{C}$  Junction Temperature
- Rugged
  - Passes Drop, Shock, and Vibration Standards: JESD22-B103, B104, B111

### Typical Application Circuit

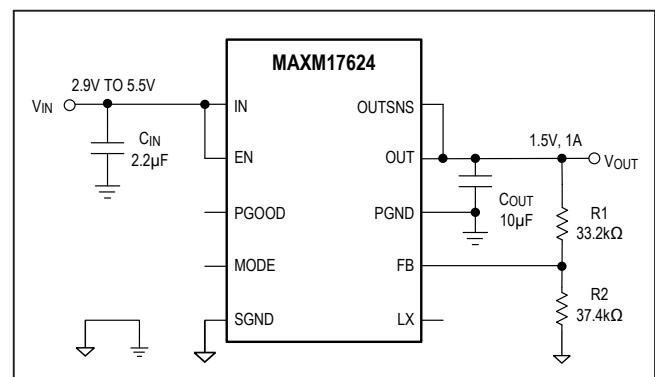

### Absolute Maximum Ratings

IN to PGND .....	-0.3V to 6V	Junction Temperature (Note1).....	+150°C
EN, PGOOD, FB, OUTSNS to SGND.....	-0.3V to 6V	Storage Temperature Range .....	-55°C to 125°C
MODE TO SGND .....	-0.3V to (IN + 0.3V)	Lead Temperature (soldering, 10s) .....	+260°C
LX, OUT TO PGND .....	-0.3V to (IN + 0.3V)	Soldering Temperature (reflow).....	+260°C
PGND TO SGND.....	-0.3V to 0.3V	Junction-to-Ambient Thermal Resistance .....	77°C/W
Output Short-Circuit Duration .....	Continuous		

Stresses beyond those listed under "Absolute Maximum Ratings" may cause permanent damage to the device. These are stress ratings only, and functional operation of the device at these or any other conditions beyond those indicated in the operational sections of the specifications is not implied. Exposure to absolute maximum rating conditions for extended periods may affect device reliability.

### Package Information

<b>PACKAGE TYPE: 10-PIN uSIP</b>	
Package Code	MA102A2+1
Outline Number	<a href="#">21-100245</a>
Land Pattern Number	<a href="#">90-100084</a>
<b>THERMAL RESISTANCE, FOUR-LAYER BOARD:</b>	
Junction to Ambient ( $\theta_{JA}$ )	77°C/W

For the latest package outline information and land patterns (footprints), go to [www.maximintegrated.com/packages](http://www.maximintegrated.com/packages). Note that a "+", "#", or "-" in the package code indicates RoHS status only. Package drawings may show a different suffix character, but the drawing pertains to the package regardless of RoHS status.

Package thermal resistances were obtained using the method described in JEDEC specification JESD51-7, using a four-layer board. For detailed information on package thermal considerations, refer to [www.maximintegrated.com/thermal-tutorial](http://www.maximintegrated.com/thermal-tutorial).

- Note 1:** Junction temperature greater than +125°C degrades operating lifetimes.
- Note 2:** Package thermal resistance is measured on an evaluation board with natural convection.

### Electrical Characteristics

( $V_{IN} = V_{EN} = 3.6V$ ,  $V_{SGND} = V_{PGND} = V_{MODE} = V_{FB} = V_{OUTSNS} = 0V$ ,  $LX = OUT = PGOOD = OPEN$ ,  $T_A = T_J = -40°C$  to  $+125°C$ , unless otherwise noted. Typical values are at  $T_A = +25°C$ . All voltages are referenced to GND, unless otherwise noted.) (Note 3)

PARAMETER	SYMBOL	CONDITIONS	MIN	TYP	MAX	UNITS
<b>INPUT SUPPLY (<math>V_{IN}</math>)</b>						
Input Voltage Range	$V_{IN}$		2.9		5.5	V
Input Supply Current	$I_{IN-SHDN}$	$V_{EN} = 0$ , Shutdown mode		0.1		$\mu A$
	$I_{Q-PFM}$	PFM Mode, No Load		40.0		$m A$
	$I_{Q-PWM}$	PWM Mode, MAXM17623		4.5		
PWM Mode, MAXM17624			6.0			
Undervoltage Lockout Threshold (UVLO)	$V_{IN\_UVLO}$	IN Rising	2.72	2.80	2.88	V
UVLO Hysteresis	$V_{IN\_UVLO\_HYS}$			200		mV

**Electrical Characteristics (continued)**

( $V_{IN} = V_{EN} = 3.6V$ ,  $V_{SGND} = V_{PGND} = V_{MODE} = V_{FB} = V_{OUTSNS} = 0V$ ,  $LX = OUT = PGOOD = OPEN$ ,  $T_A = T_J = -40^{\circ}C$  to  $+125^{\circ}C$ , unless otherwise noted. Typical values are at  $T_A = +25^{\circ}C$ . All voltages are referenced to GND, unless otherwise noted.) (Note 3)

PARAMETER	SYMBOL	CONDITIONS	MIN	TYP	MAX	UNITS
<b>ENABLE (EN)</b>						
EN Low Threshold	$V_{EN\_LOW}$	EN Falling			0.8	V
EN High Threshold	$V_{EN\_HIGH}$	EN Rising	2			V
EN Input Leakage	$I_{EN}$	EN = 5.5V, $T_A = T_J = 25^{\circ}C$		10	50	nA
<b>TIMING</b>						
Switching Frequency	$f_{SW}$	MAXM17623	1.92	2.00	2.08	MHz
		MAXM17624	3.84	4.00	4.16	
Minimum ON time	$t_{ON\_MIN}$			40		ns
Maximum Duty Cycle	$D_{MAX}$				100	%
Soft-Start time	$t_{SS}$			1		ms
<b>FEEDBACK (FB)</b>						
FB Regulation Voltage	$V_{FB\_REG}$			0.8		V
FB Voltage Accuracy	$V_{FB}$	PWM Mode	-1		+1	%
FB Input Bias Current	$I_{FB}$	FB = 0.6V, $T_A = T_J = 25^{\circ}C$		50		nA
OUTSNS Input Bias Current	$I_{OUTSNS\_BIAS}$	$V_{OUTSNS} = 1.8V$		10		$\mu A$
<b>POWER GOOD (PGOOD)</b>						
PGOOD Rising Threshold	$V_{PGOOD\_RISE}$	FB Rising	91.5	93.5	95.5	%
PGOOD Falling Threshold	$V_{PGOOD\_FALL}$	FB Falling	88	90	92	%
PGOOD Output Low	$V_{OL\_PGOOD}$	IPGOOD = 5mA			200	mV
PGOOD Output Leakage Current	$I_{LEAK\_PGOOD}$	PGOOD = 5.5V, $T_A = T_J = 25^{\circ}C$			100	nA
PGOOD Deassertion After Soft-Start				184		$\mu s$
<b>MODE</b>						
MODE Pullup Current		$V_{MODE} = GND$		5		$\mu A$
<b>THERMAL SHUTDOWN</b>						
Thermal Shutdown Rising Threshold				165		$^{\circ}C$
Thermal Shutdown Hysteresis				10		$^{\circ}C$

**Note 3:** Electrical specifications are production tested at  $T_A = +25^{\circ}C$ . Specifications over the entire operating temperature range are guaranteed by design and characterization.

Typical Operating Characteristics

( $V_{IN} = V_{EN} = 5V$ ,  $V_{SGND} = V_{PGND} = V_{MODE} = V_{FB} = V_{OUTSNS} = 0V$ ,  $LX = OUT = PGOOD = OPEN$ ,  $T_A = T_J = -40^{\circ}C$  to  $+125^{\circ}C$ , unless otherwise noted. Typical values are at  $T_A = +25^{\circ}C$ . All voltages are referenced to GND, unless otherwise noted. The circuit values for different output voltage applications are as in Table 1, unless otherwise noted.)

MAXM17623 EFFICIENCY vs. LOAD CURRENT ( $V_{OUT} = 0.8V$ , PWM AND PFM MODE)

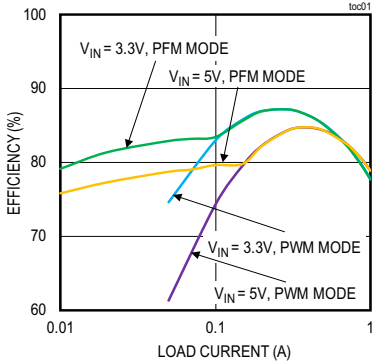

MAXM17623 EFFICIENCY vs. LOAD CURRENT ( $V_{OUT} = 1.5V$ , PWM AND PFM MODE)

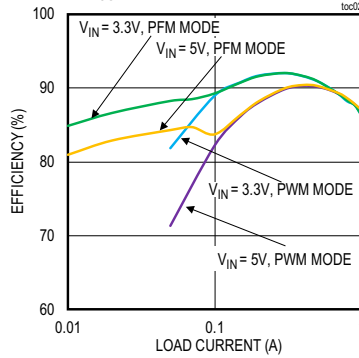

MAXM17624 EFFICIENCY vs. LOAD CURRENT ( $V_{OUT} = 3.3V$ , PWM AND PFM MODE)

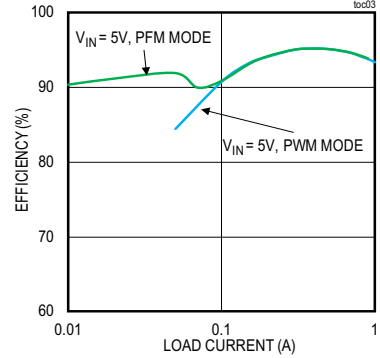

MAXM17623 OUTPUT VOLTAGE vs. LOAD CURRENT ( $V_{OUT} = 0.8V$ , PWM AND PFM MODE)

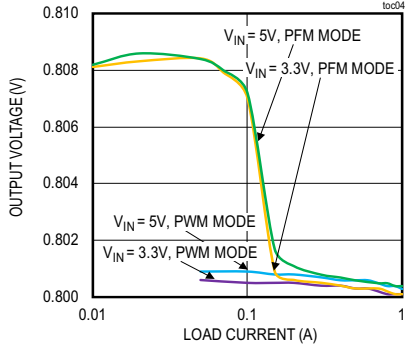

MAXM17623 OUTPUT VOLTAGE vs. LOAD CURRENT ( $V_{OUT} = 1.5V$ , PWM AND PFM MODE)

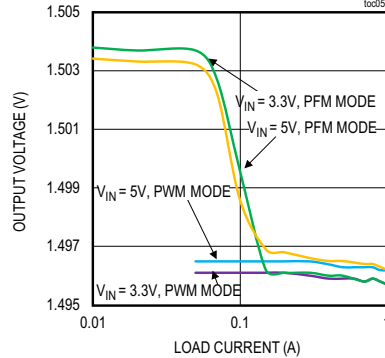

MAXM17624 OUTPUT VOLTAGE vs. LOAD CURRENT ( $V_{OUT} = 3.3V$ , PWM AND PFM MODE)

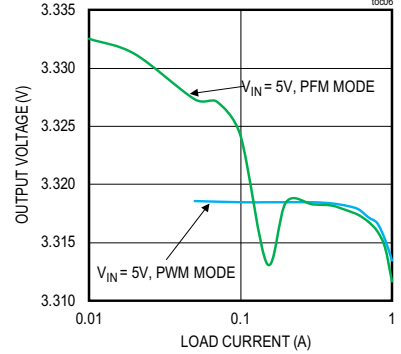

MAXM17623 LOAD TRANSIENT RESPONSE ( $V_{IN} = 3.3V$ ,  $V_{OUT} = 0.8V$ , PWM MODE) (LOAD CURRENT STEPPED FROM 0A TO 0.5A)

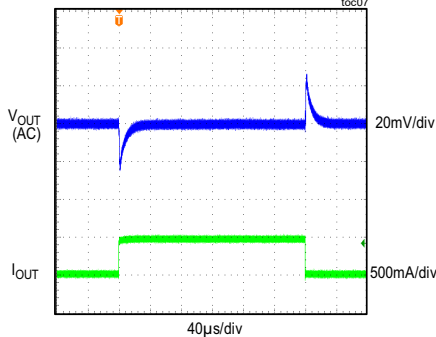

MAXM17623 LOAD TRANSIENT RESPONSE ( $V_{IN} = 3.3V$ ,  $V_{OUT} = 0.8V$ , PWM MODE) (LOAD CURRENT STEPPED FROM 0.5A TO 1A)

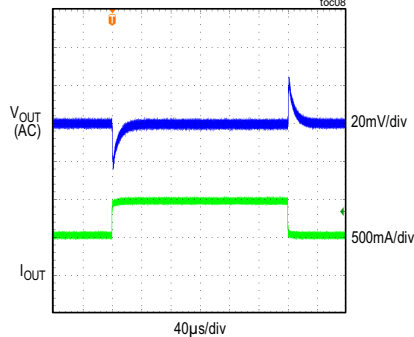

MAXM17623 LOAD TRANSIENT RESPONSE ( $V_{IN} = 3.3V$ ,  $V_{OUT} = 0.8V$ , PFM MODE) (LOAD CURRENT STEPPED FROM 0A TO 0.5A)

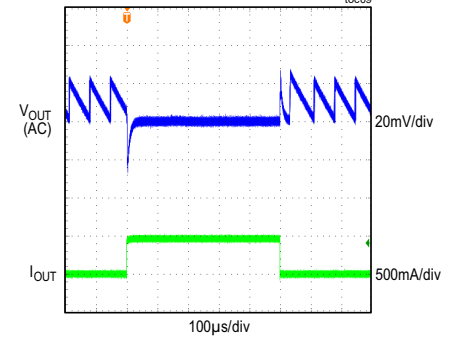

Typical Operating Characteristics (continued)

( $V_{IN} = V_{EN} = 5V$ ,  $V_{SGND} = V_{PGND} = V_{MODE} = V_{FB} = V_{OUTSNS} = 0V$ ,  $LX = OUT = PGOOD = OPEN$ ,  $T_A = T_J = -40^{\circ}C$  to  $+125^{\circ}C$ , unless otherwise noted. Typical values are at  $T_A = +25^{\circ}C$ . All voltages are referenced to GND, unless otherwise noted. The circuit values for different output voltage applications are as in [Table 1](#), unless otherwise noted.)

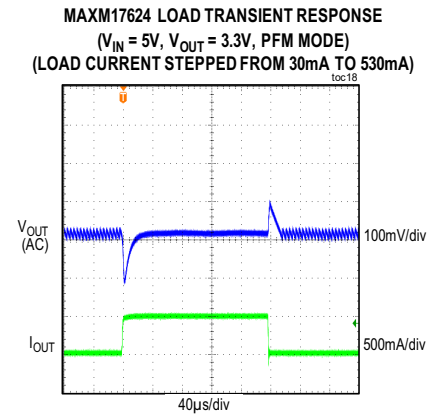
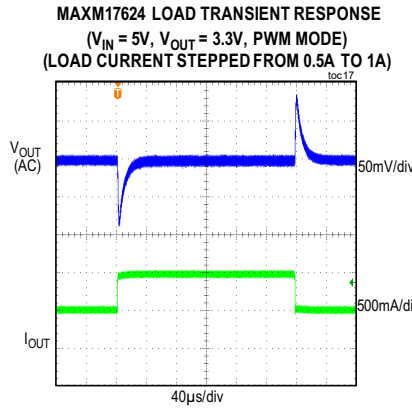
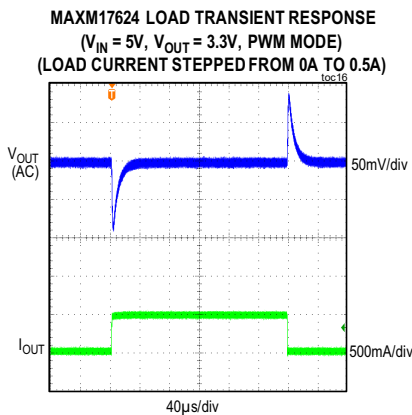
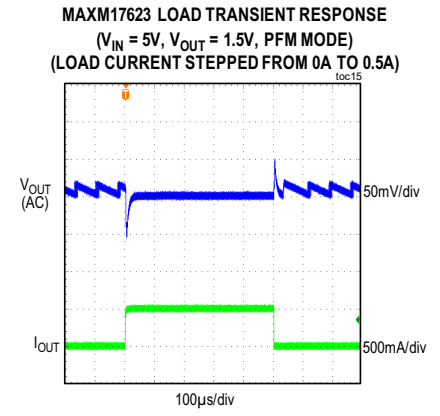
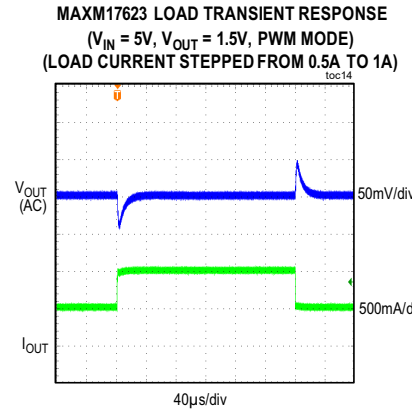
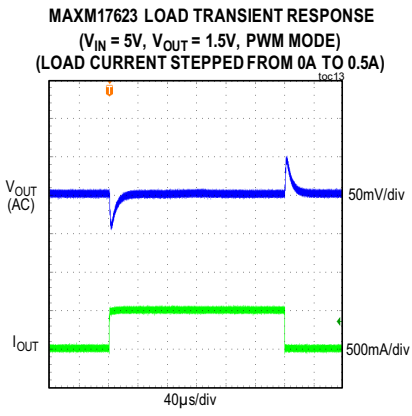
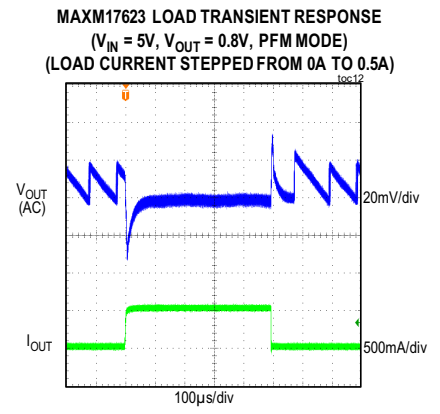
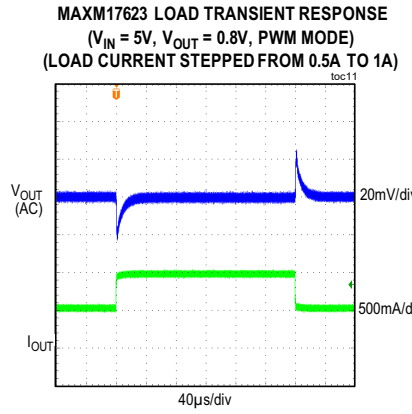
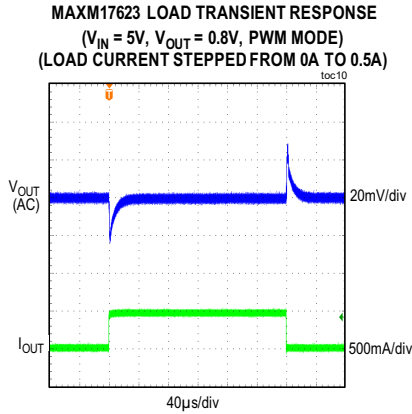

Typical Operating Characteristics (continued)

( $V_{IN} = V_{EN} = 5V$ ,  $V_{SGND} = V_{PGND} = V_{MODE} = V_{FB} = V_{OUTSNS} = 0V$ ,  $LX = OUT = PGOOD = OPEN$ ,  $T_A = T_J = -40^{\circ}C$  to  $+125^{\circ}C$ , unless otherwise noted. Typical values are at  $T_A = +25^{\circ}C$ . All voltages are referenced to GND, unless otherwise noted. The circuit values for different output voltage applications are as in [Table 1](#), unless otherwise noted.)

MAXM17623 STARTUP THROUGH ENABLE  
( $V_{IN} = 5V$ ,  $V_{OUT} = 0.8V$ ,  $I_{LOAD} = 0A$ , PWM MODE)

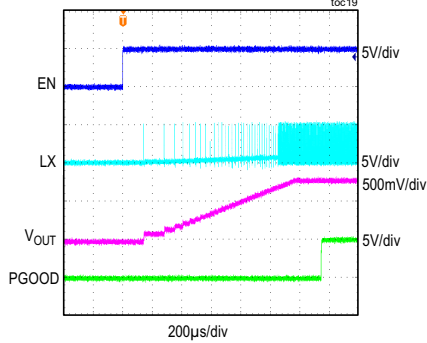

MAXM17623 STARTUP THROUGH ENABLE  
( $V_{IN} = 5V$ ,  $V_{OUT} = 0.8V$ ,  $I_{LOAD} = 1A$ , PWM MODE)

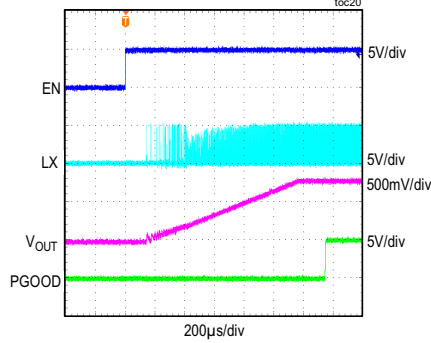

MAXM17624 STARTUP THROUGH ENABLE  
( $V_{IN} = 5V$ ,  $V_{OUT} = 3.3V$ ,  $I_{LOAD} = 0A$ , PWM MODE)

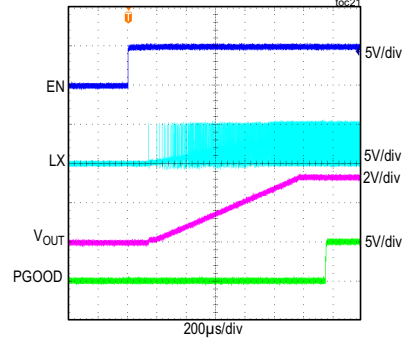

MAXM17624 STARTUP THROUGH ENABLE  
( $V_{IN} = 5V$ ,  $V_{OUT} = 3.3V$ ,  $I_{LOAD} = 1A$ , PWM MODE)

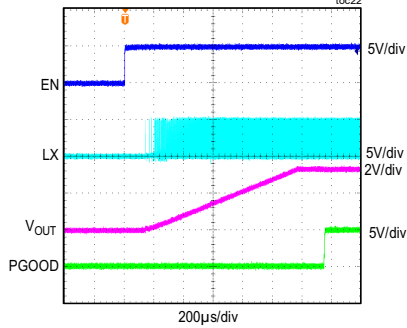

MAXM17623 SHUTDOWN THROUGH ENABLE  
( $V_{IN} = 5V$ ,  $V_{OUT} = 0.8V$ ,  $I_{LOAD} = 0A$ , PWM MODE)

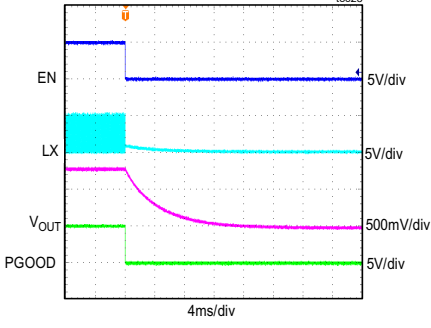

MAXM17623 SHUTDOWN THROUGH ENABLE  
( $V_{IN} = 5V$ ,  $V_{OUT} = 0.8V$ ,  $I_{LOAD} = 1A$ , PWM MODE)

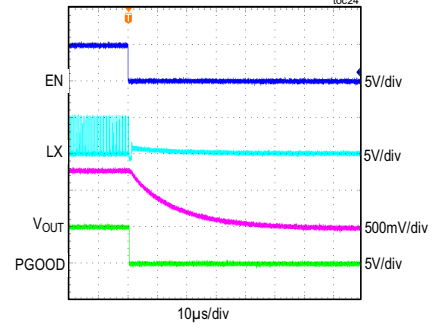

MAXM17624 SHUTDOWN THROUGH ENABLE  
( $V_{IN} = 5V$ ,  $V_{OUT} = 3.3V$ ,  $I_{LOAD} = 0A$ , PWM MODE)

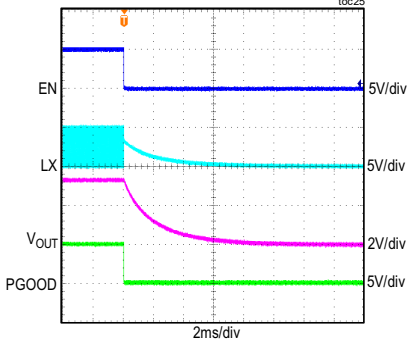

MAXM17624 SHUTDOWN THROUGH ENABLE  
( $V_{IN} = 5V$ ,  $V_{OUT} = 3.3V$ ,  $I_{LOAD} = 1A$ , PWM MODE)

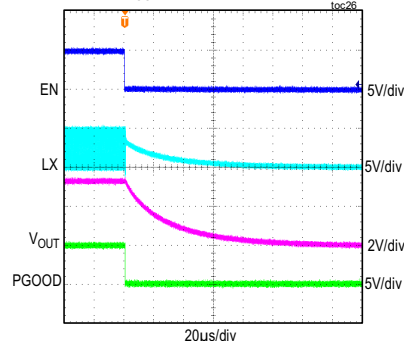

MAXM17623 STARTUP THROUGH IN  
( $V_{IN} = 5V$ ,  $V_{OUT} = 0.8V$ ,  $I_{LOAD} = 0A$ , PWM MODE)

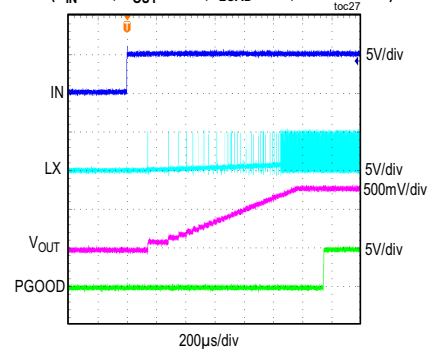

Typical Operating Characteristics (continued)

( $V_{IN} = V_{EN} = 5V$ ,  $V_{SGND} = V_{PGND} = V_{MODE} = V_{FB} = V_{OUTSNS} = 0V$ ,  $LX = OUT = PGOOD = OPEN$ ,  $T_A = T_J = -40^{\circ}C$  to  $+125^{\circ}C$ , unless otherwise noted. Typical values are at  $T_A = +25^{\circ}C$ . All voltages are referenced to GND, unless otherwise noted. The circuit values for different output voltage applications are as in [Table 1](#), unless otherwise noted.)

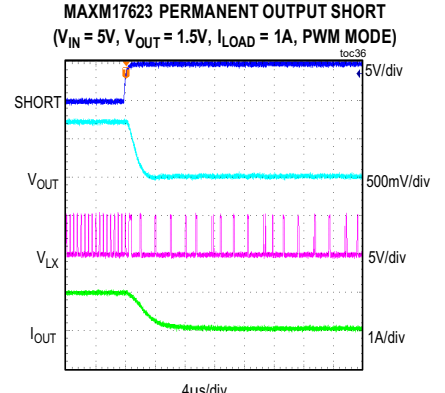
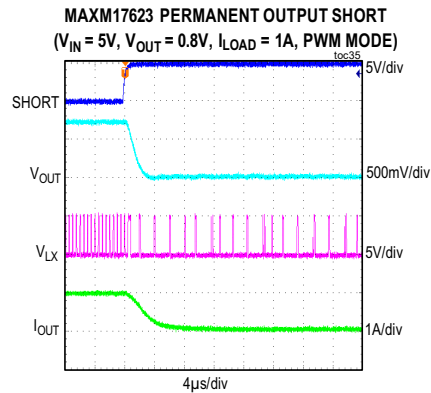
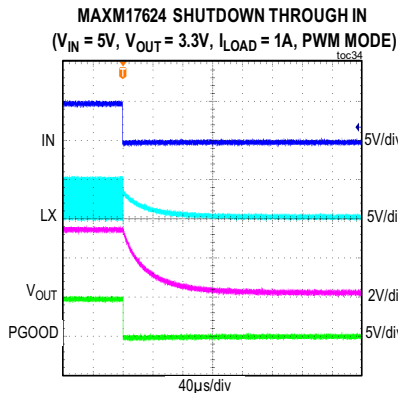
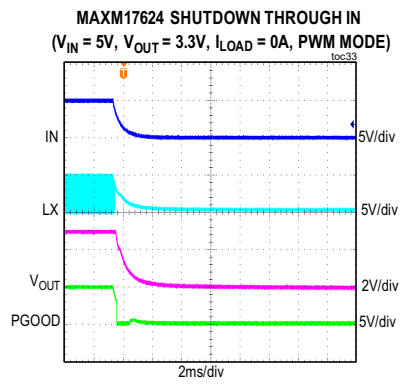
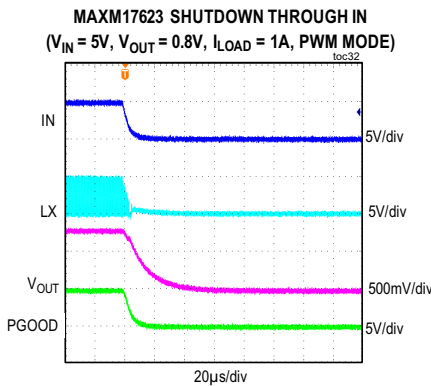
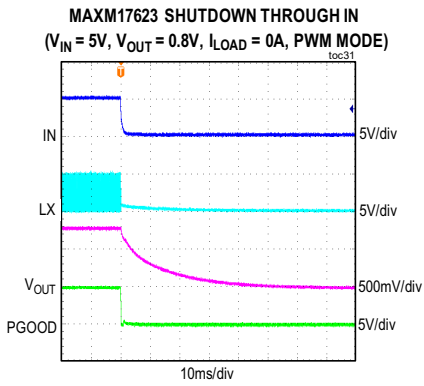
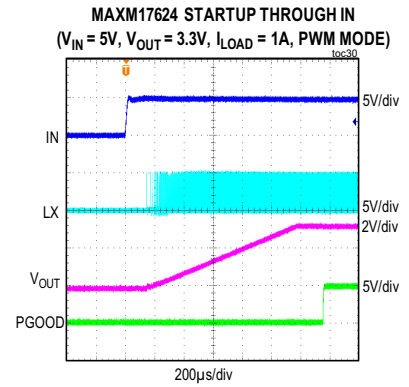
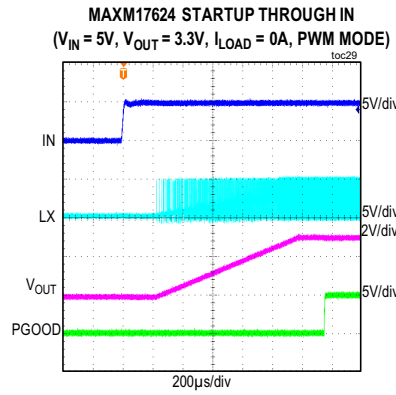
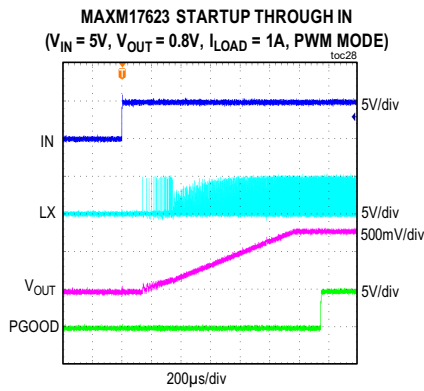

Typical Operating Characteristics (continued)

( $V_{IN} = V_{EN} = 5V$ ,  $V_{SGND} = V_{PGND} = V_{MODE} = V_{FB} = V_{OUTSNS} = 0V$ ,  $LX = OUT = PGOOD = OPEN$ ,  $T_A = T_J = -40^{\circ}C$  to  $+125^{\circ}C$ , unless otherwise noted. Typical values are at  $T_A = +25^{\circ}C$ . All voltages are referenced to GND, unless otherwise noted. The circuit values for different output voltage applications are as in [Table 1](#), unless otherwise noted.)

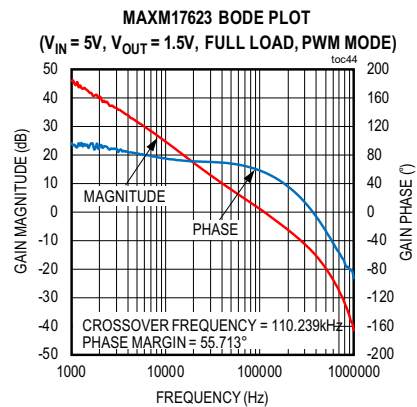
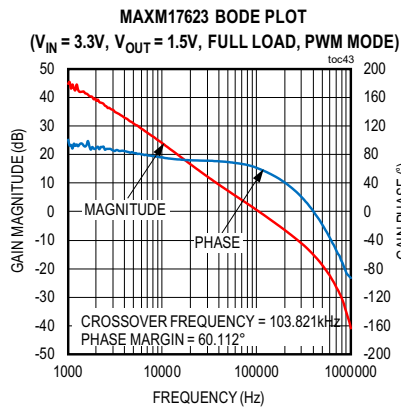
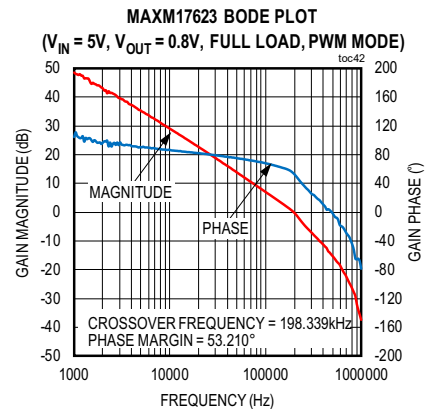
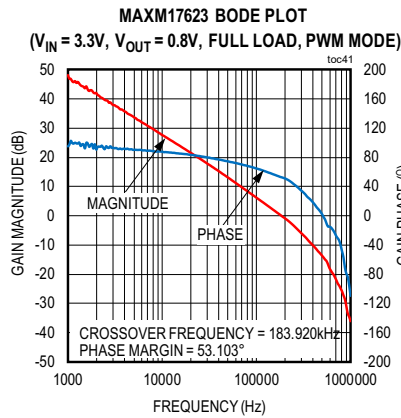
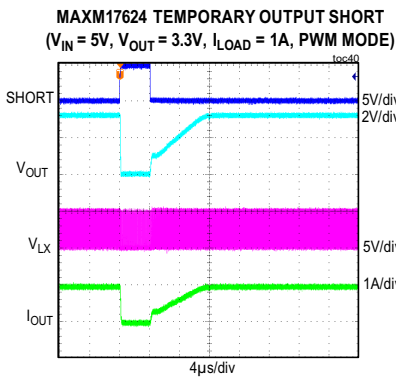
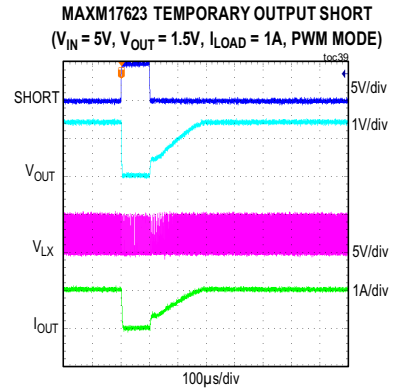
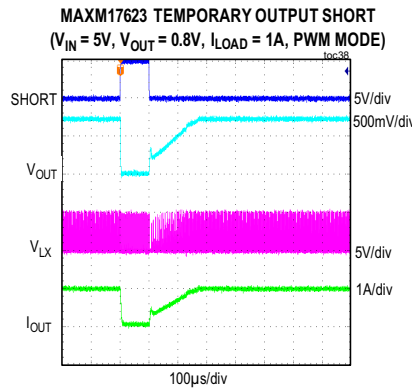
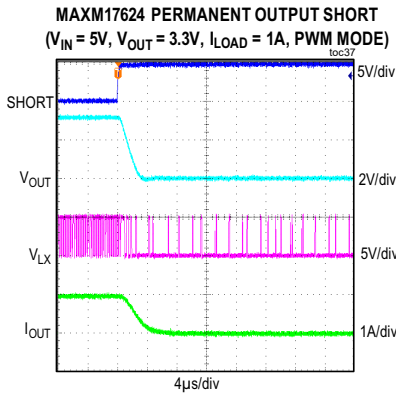



Typical Operating Characteristics (continued)

( $V_{IN} = V_{EN} = 5V$ ,  $V_{SGND} = V_{PGND} = V_{MODE} = V_{FB} = V_{OUTSNS} = 0V$ ,  $LX = OUT = PGOOD = OPEN$ ,  $T_A = T_J = -40^{\circ}C$  to  $+125^{\circ}C$ , unless otherwise noted. Typical values are at  $T_A = +25^{\circ}C$ . All voltages are referenced to GND, unless otherwise noted. The circuit values for different output voltage applications are as in [Table 1](#), unless otherwise noted.)

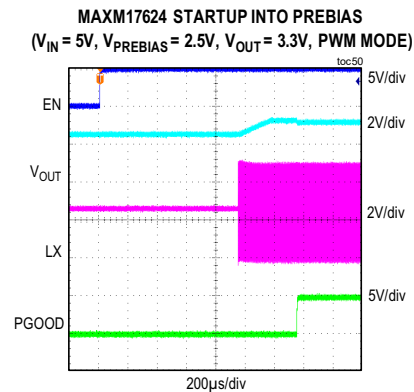
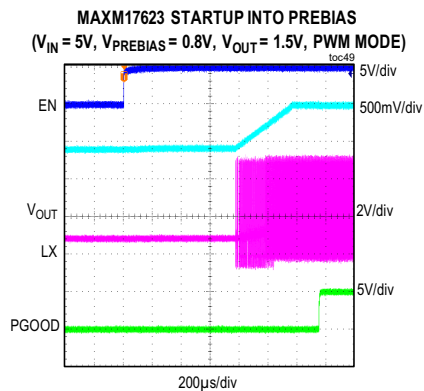
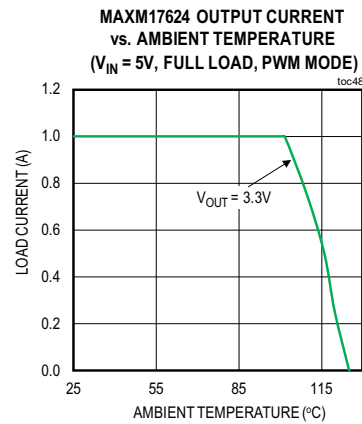
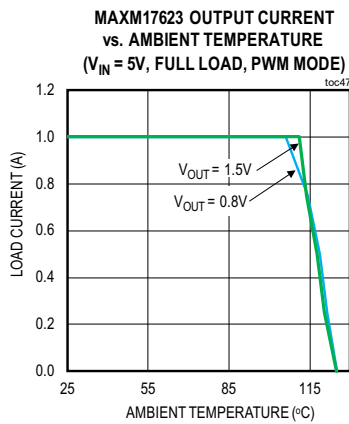
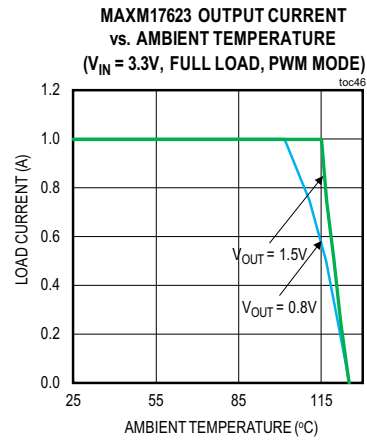
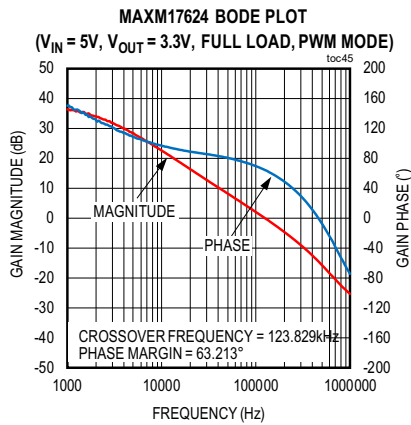

### Pin Configuration

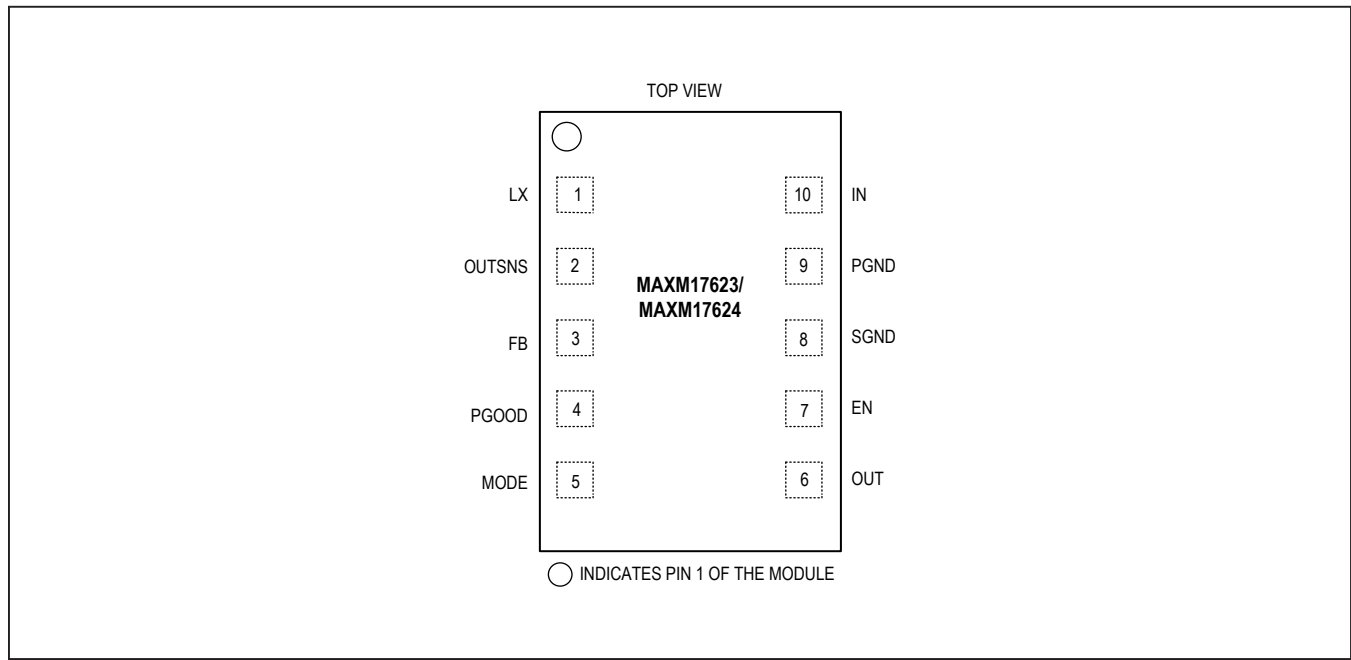

### Pin Description

PIN	NAME	FUNCTION
1	LX	Switching Node of the Inductor. No external connection.
2	OUTSNS	Sense Pin for Module $V_{OUT}$ . Connect to the positive terminal of the output capacitor $C_{OUT}$ through a kelvin connection.
3	FB	Output Feedback Connection. Connect FB to the center of the external resistor-divider from OUT to GND to set the output voltage.
4	PGOOD	Open-Drain Power Good Output. Connect the PGOOD pin to the IN pin through an external pullup resistor to generate a “high” level if the output voltage is above 93.5% of the target regulated voltage. If not used, leave this pin unconnected. The PGOOD is driven low if the output voltage is below 90% of the target regulated voltage.
5	MODE	PWM or PFM Mode Selection Input. Connect the MODE pin to GND to enable PWM-mode operation. Leave the MODE pin unconnected to enable PFM mode operation.
6	OUT	Module Output Pin. Connect the output capacitor $C_{OUT}$ from OUT to GND.
7	EN	Enable Input. Logic-high voltage on the EN pin enables the device, while logic-low voltage disables the device.
8	SGND	Signal GND Pin
9	PGND	Power Ground Pin of the Converter. Connect externally to the power ground plane. Connect the SGND and PGND pins together at the ground return path of the $V_{IN}$ bypass capacitor. Refer to the MAXM17632/MAXM17624 Evaluation Kit data sheet for a layout example.
10	IN	Power-Supply Input. Decouple the IN pin to PGND with a capacitor; place the capacitor close to the IN and PGND pin.

Functional Diagram

Internal Diagram

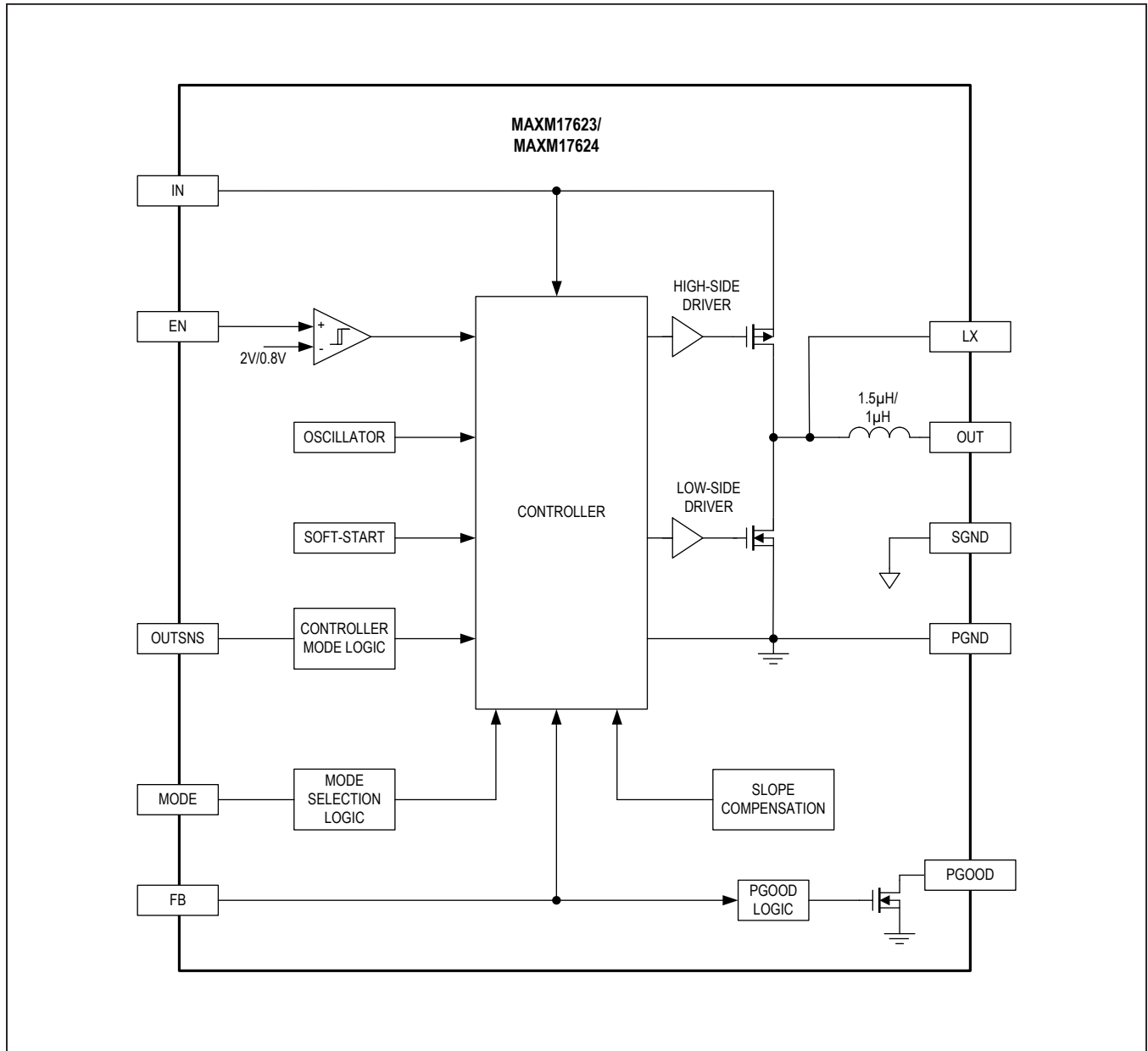

## Detailed Description

MAXM17623 and MAXM17624 are high-frequency synchronous step down DC-DC converter modules, with integrated MOSFETs, compensation components, and inductors, that operate over a 2.9V to 5.5V input voltage range. MAXM17623 and MAXM17624 support up to 1A load current and allow use of small, low cost input and output capacitors. The output voltage can be adjusted from 0.8V to 3.3V.

When the EN pin is asserted, an internal power-up sequence ramps up the error-amplifier reference, resulting in output-voltage soft-start. The FB pin monitors the output voltage through a resistor-divider. The devices select either PFM or forced-PWM mode depending on the state of the MODE pin at power-up. By pulling the EN pin to low, the devices enter shutdown mode and consume only 0.1 $\mu$ A (typ) of standby current.

The modules use an internally compensated, fixed-frequency, peak-current mode control scheme. On the falling edge of an internal clock, the high-side pMOSFET turns on, and continues to be on during normal operation until at least the rising edge of the clock (for 40ns). An internal error amplifier compares the feedback voltage to a fixed internal reference voltage and generates an error voltage. The error voltage is compared to a sum of the current-sense voltage and a slope-compensation voltage by a PWM comparator to set the on-time. During the on-time of the pMOSFET, the inductor current ramps up. For the remainder of the switching period (off-time), the pMOSFET is kept off and the low-side nMOSFET turns on. During the off-time, the inductor releases the stored energy as the inductor current ramps down, providing current to the output. Under overload conditions, the cycle-by-cycle current-limit feature limits the inductor peak current by turning off the high-side pMOSFET and turning on the low-side nMOSFET.

### Mode Selection (MODE)

The logic state of the MODE pin is latched after the EN pin goes above its rising threshold and all internal voltages are ready to allow LX switching. If the MODE pin is unconnected at power-up, the part operates in PFM mode at light loads. If the MODE pin is grounded at power-up, the part operates in constant-frequency PWM mode at all loads. State changes on the MODE pin are ignored during normal operation.

### PWM Mode

In PWM mode, the module output current is allowed to go negative. PWM operation is useful in frequency sensitive applications and provides fixed switching frequency operation at all loads. However, PWM-mode of operation gives lower efficiency at light loads compared to PFM-mode of operation.

### PFM Mode

PFM mode of operation disables negative output current from the module and skips pulses at light loads for better efficiency. At low load currents, if the peak value of the inductor current is less than 350mA for 64 consecutive cycles, and the inductor current reaches zero, the part enters PFM mode. In PFM mode, When the FB pin voltage is below 0.8V, the high-side switch is turned-on until the inductor current reaches 500mA. After the high-side switch is turned OFF, the low-side switch is turned ON until the inductor current comes down to zero and LX enters a high-impedance state. If the FB pin voltage is greater than 0.8V for 3 consecutive CLK falling edges after LX enters a high-impedance state, the module continues to operate in PFM mode. In PFM mode, the part hibernates when the FB pin voltage is above 0.8V for 5 consecutive switching cycles after LX enters a high-impedance state. If the FB pin voltage drops below 0.8V within 3 consecutive CLK falling edges after LX enters a high-impedance state, the part comes out of PFM mode.

### EN Input (EN), Soft-Start

When EN voltage is above 2V (min), the internal error-amplifier reference voltage starts to ramp up. The duration of the soft-start ramp is 1ms (typ), allowing a smooth increase of the output voltage. Driving EN low disables both power MOSFETs, as well as other internal circuitry, and reduces IN quiescent current to below 0.1 $\mu$ A.

### Power Good (PGOOD)

The devices include an open-drain power good output that indicates the output voltage status. PGOOD goes high when the output voltage is above 93.5% of the target value, and goes low when the output voltage is below 90% of the target value. During start-up, the PGOOD pin goes high after 184 $\mu$ s of soft-start completion.

### Startup into a Prebiased Output

The devices are capable of soft-start into a prebiased output, without discharging the output capacitor in both the PFM and forced-PWM modes. Such a feature is useful in applications where digital integrated circuits with multiple rails are powered.

### Overcurrent Protection

The MAXM17623/MAXM17624 are provided with a robust overcurrent protection (OCP) scheme that protects the modules under overload and output short-circuit conditions. When overcurrent is detected in the inductor, the switches are controlled by a mechanism, which detects both the high-side MOSFET and low-side MOSFET currents and compares them with the respective limits. Whenever the inductor current exceeds the internal peak current limit of 1.7A (typ), the high-side MOSFET is turned OFF and the low-side MOSFET is turned ON. The low side MOSFET is kept ON until the subsequent CLK rising edge after the inductor current drops below 1.4A (typ). The high-side MOSFET is turned ON after the low-side MOSFET is turned OFF and the cyclic operation continues. When the overload condition is removed, the part regulates output to the set voltage.

The MAXM17623/MAXM17624 are designed to support a maximum load current of 1A. The inductor ripple current is calculated as follows.

For MAXM17623:

$$\Delta I = \left[ \frac{V_{IN} - V_{OUT} - 0.191 \times I_{OUT}}{L \times f_{SW}} \right] \times \left[ \frac{V_{OUT} + 0.236 \times I_{OUT}}{V_{IN} - 0.13 \times I_{OUT}} \right]$$

For MAXM17624:

$$\Delta I = \left[ \frac{V_{IN} - V_{OUT} - 0.157 \times I_{OUT}}{L \times f_{SW}} \right] \times \left[ \frac{V_{OUT} + 0.202 \times I_{OUT}}{V_{IN} - 0.13 \times I_{OUT}} \right]$$

Where:

$V_{OUT}$  = Steady-state output voltage

$V_{IN}$  = Operating input voltage

$f_{SW}$  = Switching Frequency

$L$  = Power module output inductance (1.5 $\mu$ H  $\pm$ 20% for MAXM17623, 1 $\mu$ H  $\pm$ 20% for MAXM17624)

$I_{OUT}$  = Required output (load) current

The following condition should be satisfied at the desired load current ( $I_{OUT}$ ):

$$I_{OUT} + \frac{\Delta I}{2} < 1.8$$

### Thermal Overload Protection

Thermal overload protection limits the total power dissipation in the device. When the junction temperature exceeds +165°C, an on-chip thermal sensor shuts down the device, turns off the internal power MOSFETs, allowing the device to cool down. The thermal sensor turns the device on after the junction temperature cools by 10°C.

### Applications Information

#### Selection of Input Capacitor

The input filter capacitor reduces peak currents drawn from the power source and reduces noise and voltage ripple on the input caused by the circuit's switching.

The input capacitor RMS current requirement ( $I_{RMS}$ ) is defined by the following equation:

$$I_{RMS} = I_{OUT(MAX)} \times \frac{\sqrt{V_{OUT} \times (V_{IN} - V_{OUT})}}{V_{IN}}$$

where  $I_{OUT(MAX)}$  is the maximum load current.  $I_{RMS}$  has a maximum value when the input voltage equals twice the output voltage ( $V_{IN} = 2 \times V_{OUT}$ ), so  $I_{RMS(MAX)} = I_{OUT(MAX)}/2$ .

Choose an input capacitor that exhibits less than +10°C temperature rise at the RMS input current for optimal long-term reliability. Use low-ESR ceramic capacitors with high-ripple-current capability at the input. X7R capacitors are recommended in industrial applications for their temperature stability. Calculate the input capacitance using the following equation:

$$C_{IN} = I_{OUT(MAX)} \times D \times \frac{(1-D)}{\eta \times f_{SW} \times \Delta V_{IN}}$$

where,

$D$  = Duty ratio of the converter

$f_{SW}$  = Switching frequency

$\Delta V_{IN}$  = Allowable input voltage ripple

$\eta$  = Efficiency

**Selection of Output Capacitor**

Small ceramic X7R-grade capacitors are sufficient and recommended for the device. The output capacitor has two functions. It filters the square wave generated by the device along with the internal inductor. It stores sufficient energy to support the output voltage under load transient conditions and stabilizes the device’s internal control loop. Usually the output capacitor is sized to support a step load of 50% of the maximum output current in the application, such that the output-voltage deviation is less than 3%. Derating of ceramic capacitors with DC-voltage must be considered while selecting the output capacitor. Refer to [Table 1](#) for recommended output capacitors.

**Adjusting the Output Voltage**

The MAXM17623/MAXM17624 output voltage can be programmed from 0.8V to 3.3V. Set the output voltage by connecting a resistor-divider from output to FB to GND (see [Figure 2](#)).

Choose R2 to be less than 37.4kΩ and calculate R1 with the following equation:

$$R1 = R2 \times \left( \frac{V_{OUT}}{0.8} - 1 \right)$$

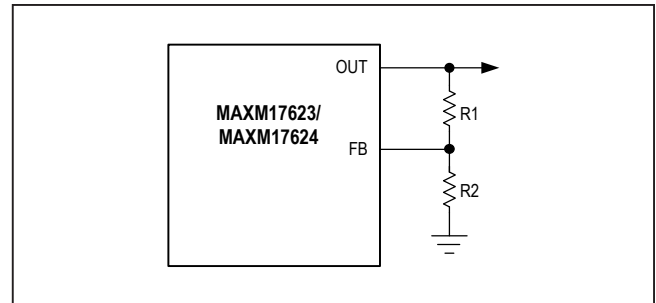

Figure 1. Setting the Output Voltage

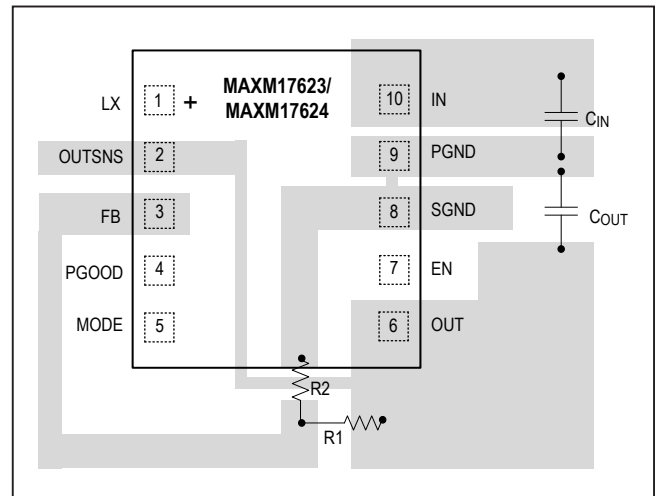

Figure 2. Layout Guidelines

**Table 1. Selection of Components**

PART NUMBER	V <sub>IN(MIN)</sub> (V)	V <sub>IN(MAX)</sub> (V)	V <sub>OUT</sub> (V)	C <sub>IN</sub>	C <sub>OUT</sub>	R1	R2
MAXM17623	2.9	5.5	0.8	1 x 2.2μF 0603 10V GRM188R71A225KE15	1 x 22μF 0805 6.3V GRM21BZ70J226ME44#	0Ω	37.4kΩ
	2.9	5.5	1.0	1 x 2.2μF 0603 10V GRM188R71A225KE15	1 x 22μF 0805 6.3V GRM21BZ70J226ME44#	9.53kΩ	37.4kΩ
	2.9	5.5	1.2	1 x 2.2μF 0603 10V GRM188R71A225KE15	1 x 22μF 0805 6.3V GRM21BZ70J226ME44#	19.1kΩ	37.4kΩ
	2.9	5.5	1.5	1 x 2.2μF 0603 10V GRM188R71A225KE15	1 x 22μF 0805 6.3V GRM21BZ70J226ME44#	33.2kΩ	37.4kΩ
MAXM17624	2.9	5.5	1.5	1 x 2.2μF 0603 10V GRM188R71A225KE15	1 x 10μF 0805 16V GRM21BZ71C106KE15#	33.2kΩ	37.4kΩ
	2.9	5.5	1.8	1 x 2.2μF 0603 10V GRM188R71A225KE15	1 x 10μF 0805 16V GRM21BZ71C106KE15#	49.9kΩ	37.4kΩ
	2.9	5.5	2.5	1 x 2.2μF 0603 10V GRM188R71A225KE15	1 x 10μF 0805 16V GRM21BZ71C106KE15#	86.6kΩ	37.4kΩ
	3.6	5.5	3.3	1 x 2.2μF 0603 10V GRM188R71A225KE15	1 x 10μF 0805 16V GRM21BZ71C106KE15#	118kΩ	37.4kΩ

**Power Dissipation**

The power dissipation inside the module leads to an increase in the junction temperature of the MAXM17623 and MAXM17624. The power loss inside the modules at full load can be estimated as follows:

$$P_{LOSS} = P_{OUT} \times \left[ \frac{1}{\eta} - 1 \right]$$

Where  $\eta$  is the efficiency of the power module at the desired operating conditions. The junction temperature  $T_J$  of the module can be estimated at any given maximum ambient temperature  $T_A$  from the following equation:

$$T_J = T_A + [\theta_{JA} \times P_{LOSS}]$$

For the MAXM17623/MAXM17624 evaluation board, the thermal resistance from Junction to Ambient ( $\theta_{JA}$ ) is 77°C/W. Operating the module at Junction temperatures greater than +125°C degrades operating lifetimes. An EE-SIM model is available for the MAXM17623/MAXM17624, to simulate efficiency and power loss for the desired operating conditions.

**PCB Layout Guidelines**

Careful PCB layout is critical to achieving low switching losses and clean, stable operation.

Use the following guidelines for good PCB layout:

- Keep the input capacitors as close as possible to the IN and PGND pins.
- Keep the output capacitors as close as possible to the OUT and PGND pins.
- Keep the resistive feedback divider as close as possible to the FB pin.
- Connect all of the PGND connections to a copper plane area as large as as possible on the top and bottom layers.
- Use multiple vias to connect internal PGND planes to the top layer PGND plane.
- Keep the power traces and load connections short. This practice is essential for high efficiency. Using thick copper PCBs (2oz vs. 1oz) can enhance full-load efficiency. Correctly routing PCB traces is a difficult task that must be approached in terms of fractions of centimeters, where a single mΩ of excess trace resistance causes a measurable efficiency penalty.

**Typical Application Circuits**

**Typical Application Circuit (0.8V, 1A)**

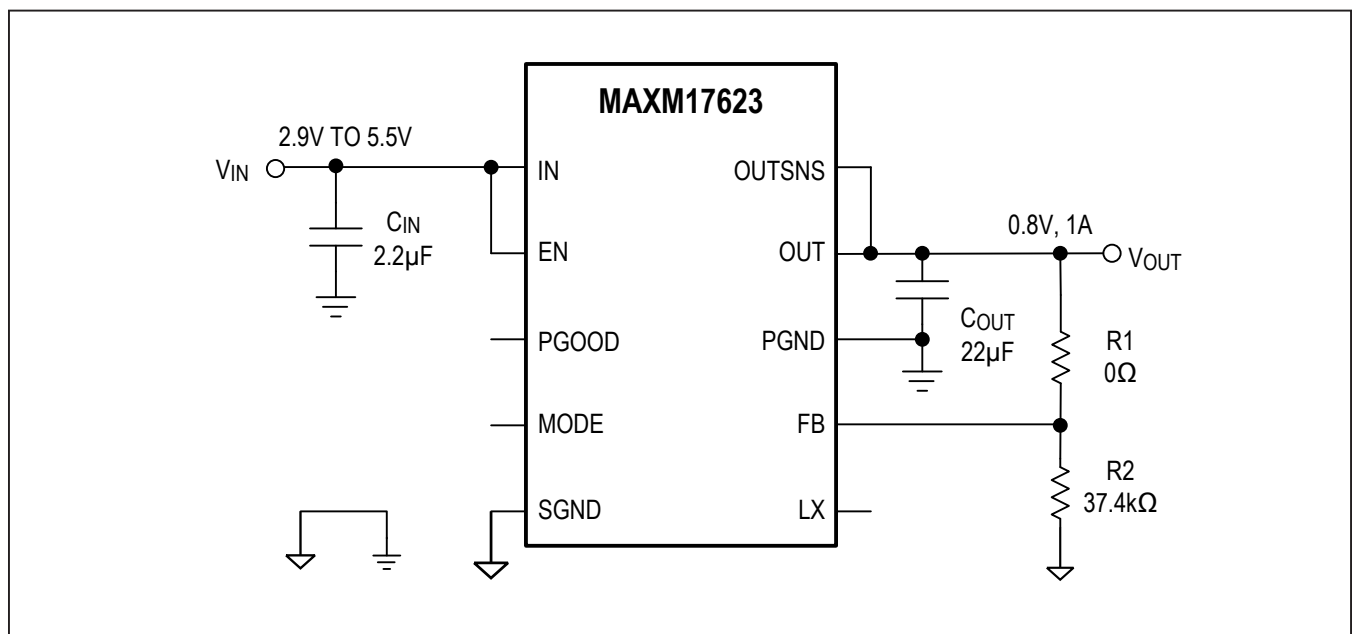

Typical Application Circuits (continued)

Typical Application Circuit (1.5V, 1A)

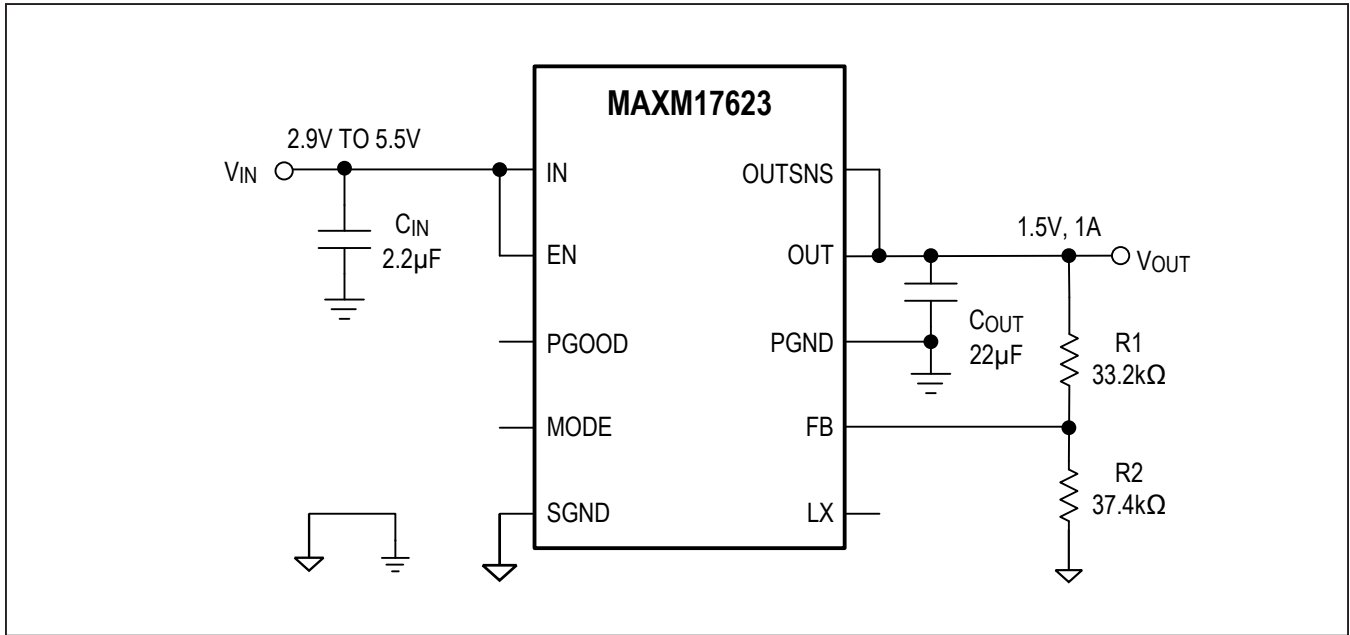

Typical Application Circuit (1.5V, 1A)

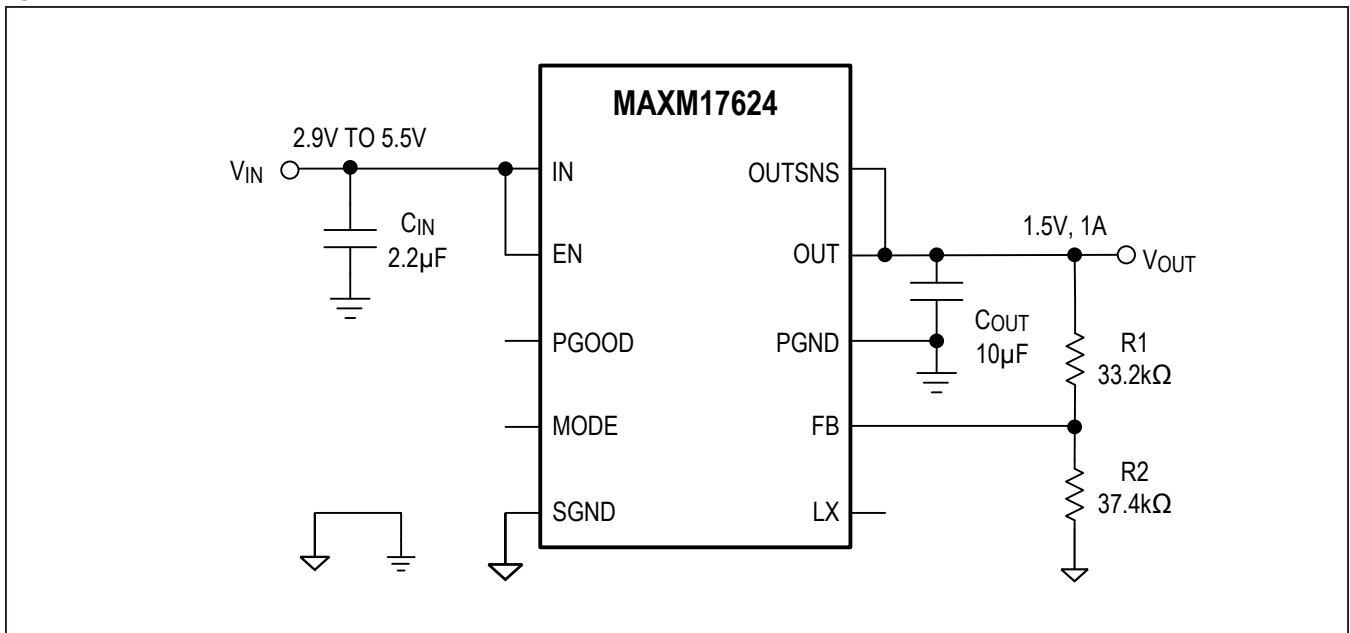



Typical Application Circuits (continued)

Typical Application Circuit (3.3V, 1A)

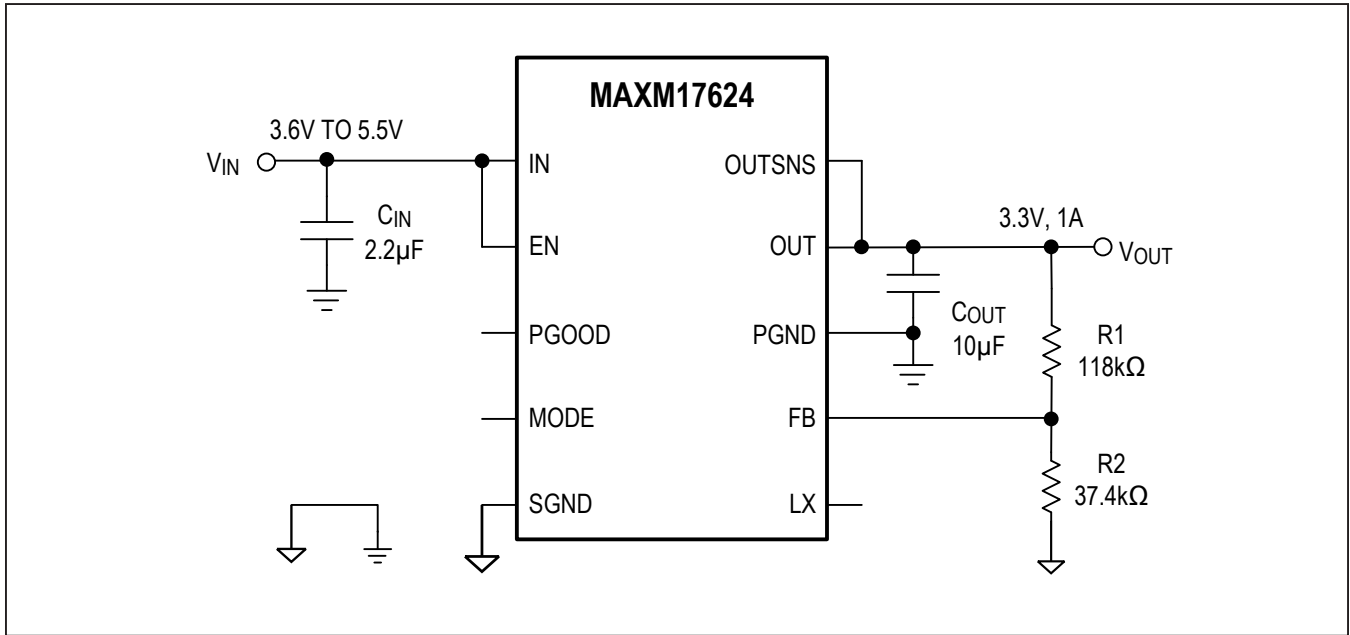

Ordering Information

PART NUMBER	TEMP RANGE	PIN-PACKAGE	V <sub>OUT</sub> (V)
MAXM17623AMB+	-40°C to +125°C	10-pin 2.6mm x 2.1mm x 1.35mm uSLIC package	0.8 to 1.5
MAXM17623AMB+T	-40°C to +125°C	10-pin 2.6mm x 2.1mm x 1.35mm uSLIC package	0.8 to 1.5
MAXM17624AMB+	-40°C to +125°C	10-pin 2.6mm x 2.1mm x 1.35mm uSLIC package	1.5 to 3.3
MAXM17624AMB+T	-40°C to +125°C	10-pin 2.6mm x 2.1mm x 1.35mm uSLIC package	1.5 to 3.3

+ Denotes a lead(Pb)-free/RoHS-compliant package.

T Denotes tape-and-reel.

## Revision History

REVISION NUMBER	REVISION DATE	DESCRIPTION	PAGES CHANGED
0	12/18	Initial release	—
1	2/19	Updated TOC05, TOC17, and Table 1	4–5, 14

For pricing, delivery, and ordering information, please visit Maxim Integrated's online storefront at <https://www.maximintegrated.com/en/storefront/storefront.html>.

*Maxim Integrated cannot assume responsibility for use of any circuitry other than circuitry entirely embodied in a Maxim Integrated product. No circuit patent licenses are implied. Maxim Integrated reserves the right to change the circuitry and specifications without notice at any time. The parametric values (min and max limits) shown in the Electrical Characteristics table are guaranteed. Other parametric values quoted in this data sheet are provided for guidance.*