









Ficha técnica

Rueda IB-PGI 1-0265

Codigo				Tipo cojinete Eje					
1-0265	40	30	35x2	—	70x55	54x38	6	65	40



Características

Soprote embutido de chapa de acero hasta 3 mm de espesor.
Acabado cincado.
Soprote con rodamiento de bolas.
Fabricadas según normas europeas EN 12528.

Datos técnicos

Diámetro: 40 mm
Carga: 30 kg
Tipo de cojinete: Cojinete Liso
Ancho de Banda de rodadura: 35x2 mm
Medidas de placa superior: 70x55 mm
Distancia entre agujeros: 54x38 mm
Diámetro agujero sujeción platina: 6 mm
Altura total: 65 mm
Radio de giro: 40 mm

Archivos CAD

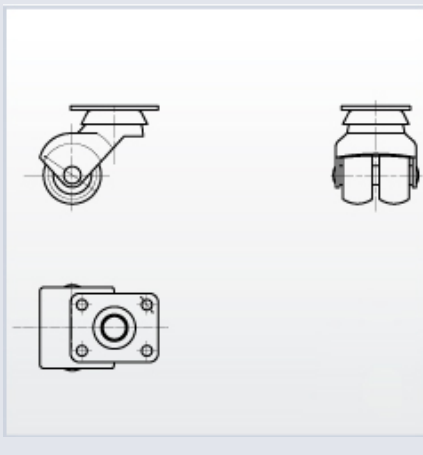
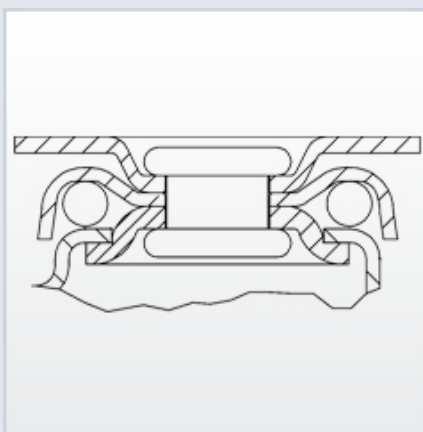

Rueda

PGI (Goma)
Núcleo de poliamix y banda de goma gris
Rango de temperatura: -20° ÷ +60°