



Figure can vary

Part no.: 50135452
M7-V1-MW3-DS-C-T-M12-200
Muting indicator



Contents

- Technical data
- Dimensioned drawings
- Electrical connection
- Notes

Part no.: 50135452 – M7-V1-MW3-DS-C-T-M12-200 – Muting indicator

Technical data

Basic data	
Series	M7
Type of signaling	Optical
Optical data	
Light source	White
Electrical data	
Life expectancy	> 100,000 h
Performance data	
Supply voltage U_B	24 V , AC/DC , 10 %
Current consumption, max.	58 mA
Connection	
Number of connections	1 Piece(s)
Connection 1	
Type of connection	Cable with connector
Function	Voltage supply
Cable length	2,000 mm
Thread size	M12
Type	Male
Material	Metal
No. of pins	5 -pin
Encoding	A-coded
Mechanical data	
Design	Cylindrical
Dimension (Ø x L)	70 mm x 200 mm
Housing material	Plastic , PC
Housing color	Black Clear
Type of illuminant	LED/24V
Signal image	Continuous light
Lens color	Clear
Angle of radiation	360°
Environmental data	
Ambient temperature, operation	-30 ... 60 °C
Certifications	
Degree of protection	IP 66
Certifications	c UL US CE
Classification	
Customs tariff number	85318070
eCl@ss 8.0	27371220
eCl@ss 9.0	27371220

ETIM 5.0	EC000232
ETIM 6.0	EC000232

Dimensioned drawings

All dimensions in millimeters

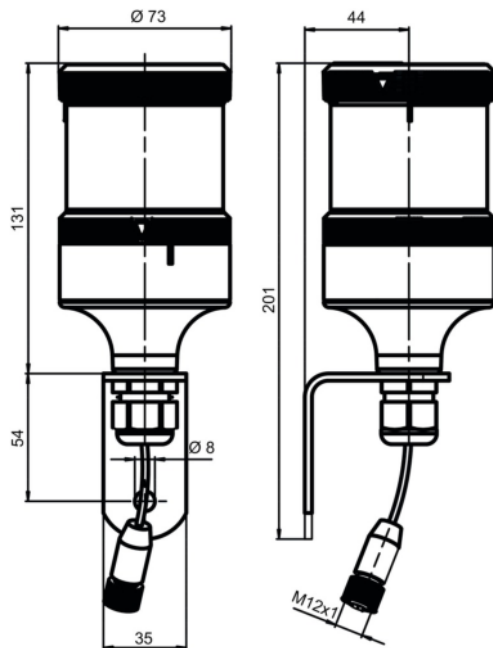

Electrical connection

Connection 1	
Type of connection	Cable with connector
Function	Voltage supply
Cable length	2,000 mm
Sheathing material	
Cable color	Black
Wire cross section	
Thread size	M12
Type	Male
Material	Metal
No. of pins	5 -pin
Encoding	A-coded

Notes

Observe intended use!

- This product is not a safety sensor and is not intended as personnel protection.
- The product may only be put into operation by competent persons.
- Only use the product in accordance with its intended use.