

EVAL-M1-101TF user guide

iMOTION™ Modular Application Design Kit

About this document

Scope and purpose

This user guide provides an overview of the evaluation board EVAL-M1-101TF including its main features, key data and mechanical dimensions.

EVAL-M1-101TF is an evaluation-board as part of the iMOTION™ modular application design kit (MADK). This board features and demonstrates Infineon's advanced motion control engine (MCE 2.0) technology for permanent-magnet motor drives over the full speed range.

The evaluation board EVAL-M1-101TF was developed to support customers during their first steps designing applications using permanent magnet motors via sensorless sinusoidal control.

Intended audience

This user guide is intended for all technical specialists who have a knowledge of motor control and high-power electronics converters. The board is intended for use under laboratory conditions.

This board will be used during design-in, for evaluation and measurement of characteristics, and proof of data sheet specifications.

Evaluation Board

This board will be used during design in, for evaluation and measurement of characteristics, and proof of data sheet specifications.

Note: PCB and auxiliary circuits are NOT optimized for final customer design.

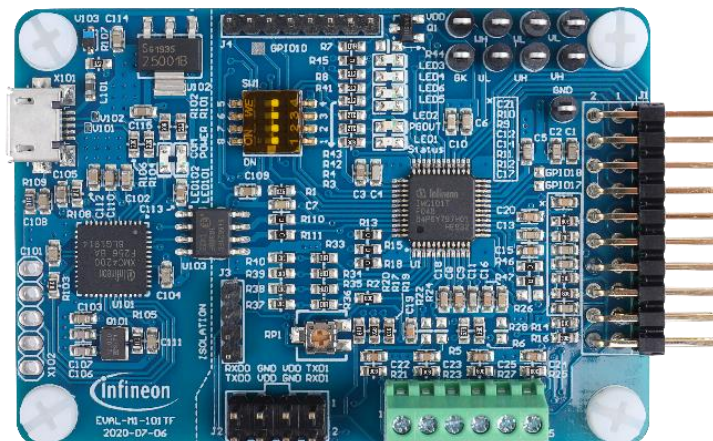

Important notice

Important notice

“Evaluation Boards and Reference Boards” shall mean products embedded on a printed circuit board (PCB) for demonstration and/or evaluation purposes, which include, without limitation, demonstration, reference and evaluation boards, kits and design (collectively referred to as “Reference Board”).

Environmental conditions have been considered in the design of the Evaluation Boards and Reference Boards provided by Infineon Technologies. The design of the Evaluation Boards and Reference Boards has been tested by Infineon Technologies only as described in this document. The design is not qualified in terms of safety requirements, manufacturing and operation over the entire operating temperature range or lifetime.

The Evaluation Boards and Reference Boards provided by Infineon Technologies are subject to functional testing only under typical load conditions. Evaluation Boards and Reference Boards are not subject to the same procedures as regular products regarding returned material analysis (RMA), process change notification (PCN) and product discontinuation (PD).

Evaluation Boards and Reference Boards are not commercialized products, and are solely intended for evaluation and testing purposes. In particular, they shall not be used for reliability testing or production. The Evaluation Boards and Reference Boards may therefore not comply with CE or similar standards (including but not limited to the EMC Directive 2004/EC/108 and the EMC Act) and may not fulfill other requirements of the country in which they are operated by the customer. The customer shall ensure that all Evaluation Boards and Reference Boards will be handled in a way which is compliant with the relevant requirements and standards of the country in which they are operated.

The Evaluation Boards and Reference Boards as well as the information provided in this document are addressed only to qualified and skilled technical staff, for laboratory usage, and shall be used and managed according to the terms and conditions set forth in this document and in other related documentation supplied with the respective Evaluation Board or Reference Board.

It is the responsibility of the customer’s technical departments to evaluate the suitability of the Evaluation Boards and Reference Boards for the intended application, and to evaluate the completeness and correctness of the information provided in this document with respect to such application.

The customer is obliged to ensure that the use of the Evaluation Boards and Reference Boards does not cause any harm to persons or third party property.

The Evaluation Boards and Reference Boards and any information in this document is provided "as is" and Infineon Technologies disclaims any warranties, express or implied, including but not limited to warranties of non-infringement of third party rights and implied warranties of fitness for any purpose, or for merchantability.

Infineon Technologies shall not be responsible for any damages resulting from the use of the Evaluation Boards and Reference Boards and/or from any information provided in this document. The customer is obliged to defend, indemnify and hold Infineon Technologies harmless from and against any claims or damages arising out of or resulting from any use thereof.

Infineon Technologies reserves the right to modify this document and/or any information provided herein at any time without further notice.

Safety precautions

Safety precautions

Note: Please note the following warnings regarding the hazards associated with development systems.

Table 1 Safety precautions

	<p>Warning: The DC link potential of this board is up to 310 V_{DC}. When measuring voltage waveforms by oscilloscope, high voltage differential probes must be used. Failure to do so may result in personal injury or death.</p>
	<p>Warning: The reference board contains DC bus capacitors which take time to discharge after removal of the main supply. Before working on the drive system, wait five minutes for capacitors to discharge to safe voltage levels. Failure to do so may result in personal injury or death. Darkened display LEDs are not an indication that capacitors have discharged to safe voltage levels.</p>
	<p>Warning: The reference board is connected to the grid input during testing. Hence, high-voltage differential probes must be used when measuring voltage waveforms by oscilloscope. Failure to do so may result in personal injury or death. Darkened display LEDs are not an indication that capacitors have discharged to safe voltage levels.</p>
	<p>Warning: Remove or disconnect power from the drive before you disconnect or reconnect wires, or perform maintenance work. Wait five minutes after removing power to discharge the bus capacitors. Do not attempt to service the drive until the bus capacitors have discharged to zero. Failure to do so may result in personal injury or death.</p>
	<p>Caution: The heat sink and device surfaces of the reference board may become hot during testing. Hence, necessary precautions are required while handling the board. Failure to comply may cause injury.</p>
	<p>Caution: Only personnel familiar with the drive, power electronics and associated machinery should plan, install, commission and subsequently service the system. Failure to comply may result in personal injury and/or equipment damage.</p>
	<p>Caution: The reference board contains parts and assemblies sensitive to electrostatic discharge (ESD). Electrostatic control precautions are required when installing, testing, servicing or repairing the assembly. Component damage may result if ESD control procedures are not followed. If you are not familiar with electrostatic control procedures, refer to the applicable ESD protection handbooks and guidelines.</p>
	<p>Caution: A drive that is incorrectly applied or installed can lead to component damage or reduction in product lifetime. Wiring or application errors such as undersizing the motor, supplying an incorrect or inadequate AC supply, or excessive ambient temperatures may result in system malfunction.</p>
	<p>Caution: The reference board is shipped with packing materials that need to be removed prior to installation. Failure to remove all packing materials that are unnecessary for system installation may result in overheating or abnormal operating conditions.</p>

Table of contents

About this document	1
Important notice	2
Safety precautions	3
Table of contents	4
1 The board at a glance	5
1.1 Delivery content	5
1.2 Block diagram.....	6
1.3 Board parameters and technical data.....	8
2 System and functional description	9
2.1 Commissioning.....	9
2.2 iMOTION™ development tools and software	10
2.2.1 MCEWizard setup overview.....	10
2.2.2 MCEDesigner setup overview.....	12
2.3 Description of the functional blocks.....	15
2.4 Motor current feedback circuitry.....	15
2.4.1 Motor shunt configuration.....	15
2.4.2 Motor external current feedback configuration and calculation	15
2.4.3 Motor internal current feedback amplifier gain configuration	17
2.5 EVAL-M1-101TF analog inputs and their MCEWizard setup.....	18
2.5.1 DC bus-sensing configuration.....	18
2.5.2 NTC shutdown value calculation and configuration	19
2.5.3 VSP analog input control mode and PGOUT configuration	19
3 System design	23
3.1 Schematics	23
3.2 PCB layout	23
4 Bill of materials	26
4.1 Connector details	27
5 References and appendices	30
5.1 References	30
5.2 Ordering information	30
Revision history	31

The board at a glance

1 The board at a glance

The EVAL-M1-101TF evaluation board is a part of the iMOTION™ modular application design kit for drives (iMOTION™ MADK). In order to run a motor, the mating power board is required to interface this evaluation board. The MADK platform is intended for use with various power stages and different control boards. These boards can easily be interfaced via the 20-pin iMOTION™ MADK M1, or the 30-pin iMOTION™ MADK M3 interface connector. This board is equipped with a 20-pin M1 connector and is intended for running a single motor.

This evaluation board is designed to give comprehensible solutions of sensorless control of permanent magnet motors over the full speed range. It provides Hall-sensor based or sensorless controls applying 3-phase and type 3 of 2-phase modulation. The PC interface is via a micro-USB connector and the on-board debugger is galvanically isolated. The PC interface provides a UART connection to the MCE.

The EVAL-M1-101TF evaluation board is available from Infineon. The features of this board are described in the main features chapter of this document, whereas the remaining paragraphs provide information to enable the customers to copy, modify and qualify the design for production according to their own specific requirements.

Environmental conditions were considered in the design of the EVAL-M1-101TF, but the board is not qualified in terms of safety requirements or manufacturing and operation over the entire operating temperature range or lifetime. The boards provided by Infineon are subject to functional testing only.

Evaluation boards are not subject to the same procedures as regular products regarding returned material analysis (RMA), process change notification (PCN) and product discontinuation (PD). Evaluation boards are intended to be used under laboratory conditions by technical specialists only.

1.1 Delivery content

The delivery includes the finished board as shown in Figure 1. And the detail ordering information is indicated in chapter 5.2.

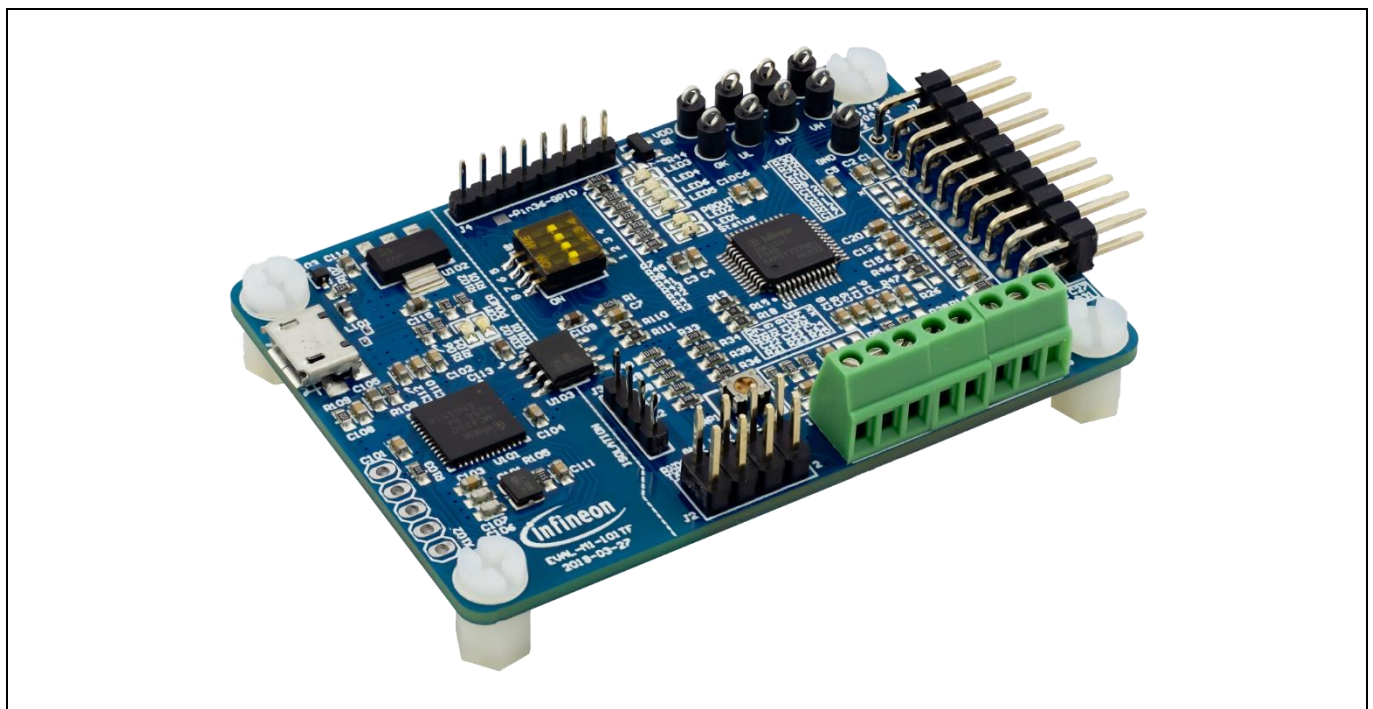

Figure 1 Evaluation board EVAL-M1-101TF

The board at a glance

1.2 Block diagram

Figure 2 shows a typical block diagram of a motor control application using the IMC101T-F048. The IMC101T-F048 provides a built-in, closed loop and sensorless control algorithm using the unique flexible motion control engine (MCE) for permanent magnet motors. The MCE consists of a collection of control elements, motion peripherals, a dedicated motion control sequencer and internal memory to map internal signal nodes. IMC101T-F048 also employs a unique single shunt current reconstruction circuit in addition to a leg shunt current sensing circuit to eliminate additional analog/digital circuitry.

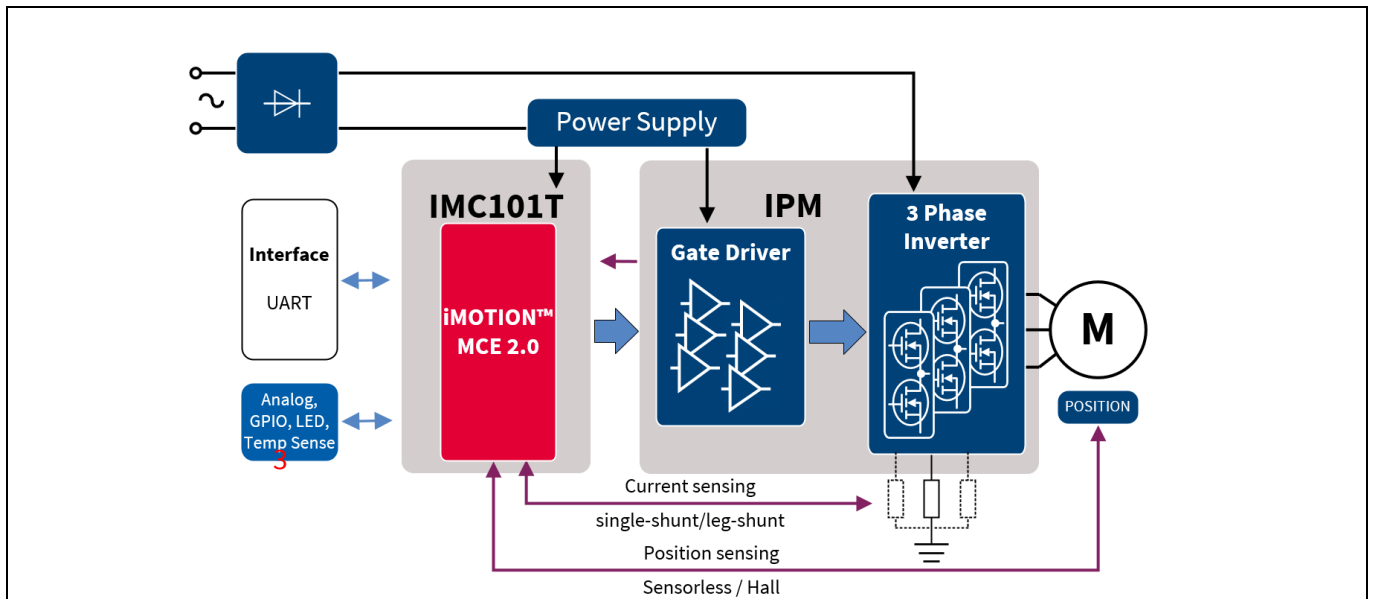

Figure 2 Typical application block diagram using IMC101T-F048

Figure 3 points out the functional groups on the top side of the EVAL-M1-101TF board.

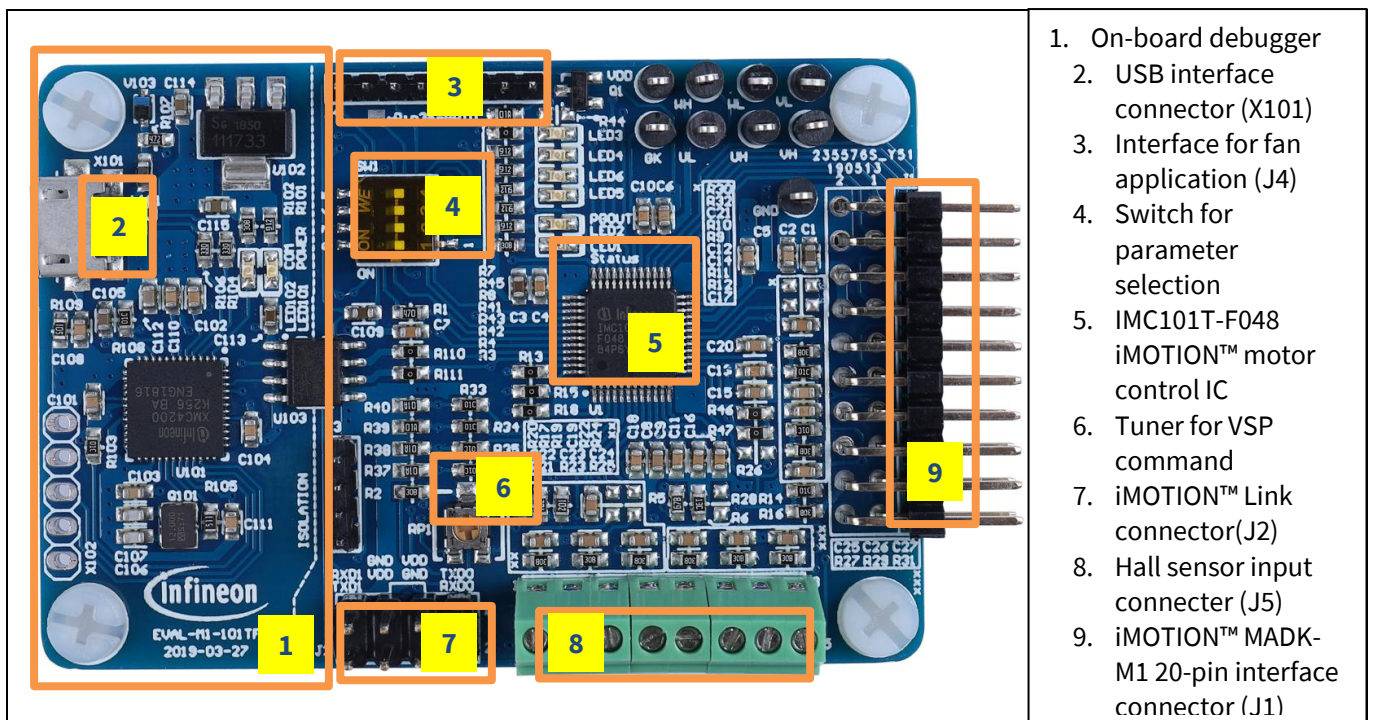

Figure 3 Functional groups on top side of the board

The board at a glance

Main features

EVAL-M1-101TF is an evaluation control board for motor control applications. The kit demonstrates Infineon's motion control IC technology.

Main features of the IMC101T-F048 motion control IC include:

- MCE (motion control engine) as ready-to-use solution for variable speed drives
- Field-oriented control (FOC) for permanent magnet synchronous motor (PMSM)
- Space vector PWM with sinusoidal commutation and integrated protection features
- Current sensing via single or leg shunt
- Sensorless or Hall-sensor based operation
- Various serial communication interfaces (UART)
- Multiple motor parameter support
- Flexible host interface options for speed commands: UART, PWM or analog signal
- UL / CSA 60730 certified (Class B)
- 3.3 V (default) or 5 V VDD power supply
- LPFP-48 package

The evaluation board characteristics:

- Complete kit for running any permanent magnet motor via sensorless sinusoidal control
- 3.3 V for on-board debugger is powered by USB interface, and motor controller side is powered by power board
- Micro-USB connector and on-board debugger galvanically isolated from power side
- Capable of 3-phase and type 3 of 2-phase modulation
- Connector for digital Hall switches or analog Hall sensors
- Connector to input analog or digital (frequency, duty) speed control signals
- LEDs, switches and potentiometer to test scripting capabilities
- Test points for direct measurement of voltages, currents, etc.
- RoHS compliant
- PCB size is 65 x 45 mm

The board at a glance

1.3 Board parameters and technical data

Table 2 depicts the key specifications of the evaluation board EVAL-M1-101TF.

Table 2 EVAL-M1-101TF board specifications

Parameter	Symbol	Conditions / comments	Value	Unit
Controller supply voltage	VDD	Supplied from power board.	3.3(default), 5	V
Host interface (not isolated)				
UART (TXD, RXD)		UART0, UART1	0 - VDD	
AIN		Analog input	0 - VDD	
DIN		Digital input	0 - VDD	
DOUT		Digital output	0 - VDD	
DC bus voltage feedback				
DC bus scaling		13.3 kΩ resistor on control board, and 2 MΩ resistor on power board	8.20	Count/V
DC bus scaling range			0 - 499.54	V
Current feedback				
Motor internal current feedback amplifier gain		Configured by MCEWizard	1, 3, 6, 12	
Motor current sensing device		Single shunt resistor or leg shunt resistor	0 - VDD/Gain	
Motor current op-amp configuration		Default setting	Non-inverting	
Motor current external amplification gain			0.833	
Resolution		PCB design may reduce the resolution	12	bit
Protection				
NTC temperature shutdown value		Configured by MCEWizard	0 - VDD	V
PCB characteristics				
Dimension		Square	65 x 45	mm
Material		FR4, 1.6 mm thickness, Copper thickness = 1 oz (35um)		

2 System and functional description

2.1 Commissioning

In order to run the motor system, a combination of the iMOTION™ MADK control board (EVAL-M1-101TF) and the matching MADK power board (with M1 connector) is required. The iMOTION™ software tools, MCEDesigner and MCEWizard, are also required to initially set up the system, as well as to control and fine-tune the system performance to match users' exact needs. This chapter provides more details on setting up the system and getting started with the iMOTION™ MADK development platform.

The EVAL-M1-101TF consists of several functional groups, which enable an out-of-the-box, fully functional motor control system combined with additional interfaces and test points for more advanced use cases. Figure 3 shows the functional groups of the EVAL-M1-101TF evaluation board.

Figure 4 shows the basic system connection using the EVAL-M1-101TF together with the EVAL-M1-05-65D.

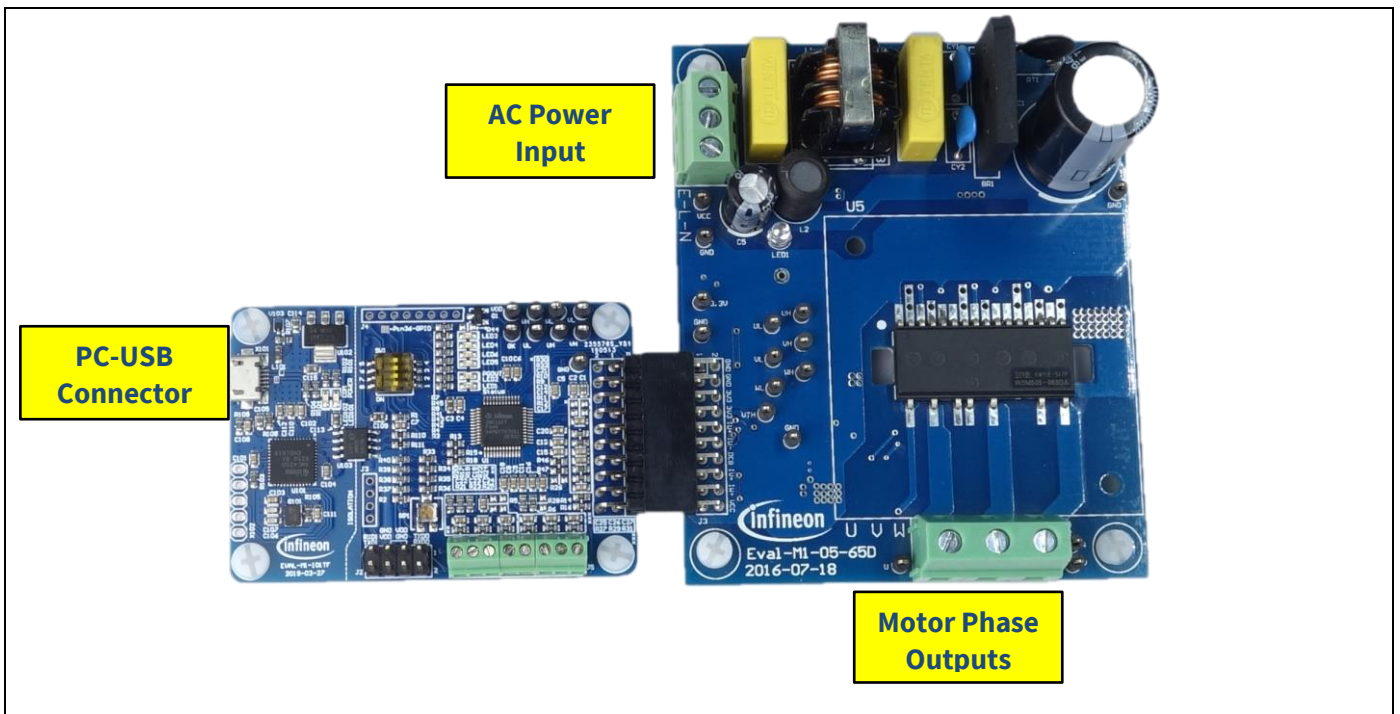

Figure 4 System connection example using EVAL-M1-101TF and EVAL-M1-05-65D

2.2 iMOTION™ development tools and software

The iMOTION™ development tool installers for MCEDesigner and MCEWizard are available for download via the Infineon iMOTION™ website (<http://www.infineon.com/imotion-software>). All supported tools and software variants are listed there. Please visit this page periodically to check for tool/software updates.

The isolated on-board debugger provides the USB to UART bridge between the PC and the target iMOTION™ device with 1kV DC galvanic isolation between the motor drive system (hot side) and the PC/debugger (cold side). The on-board debugger uses the SEGGER J-Link driver for UART communication with IMC101T-F048. The J-Link driver will be installed during the MCEDesigner installation. In case the driver is not installed properly, please go to [SEGGER J-Link website](#) to download and install the latest J-Link “Software and Documentation pack for Windows.”

2.2.1 MCEWizard setup overview

After installing the MCEWizard, please read the MCEWizard user guide first. Figure 5 shows the welcome page of MCEWizard.

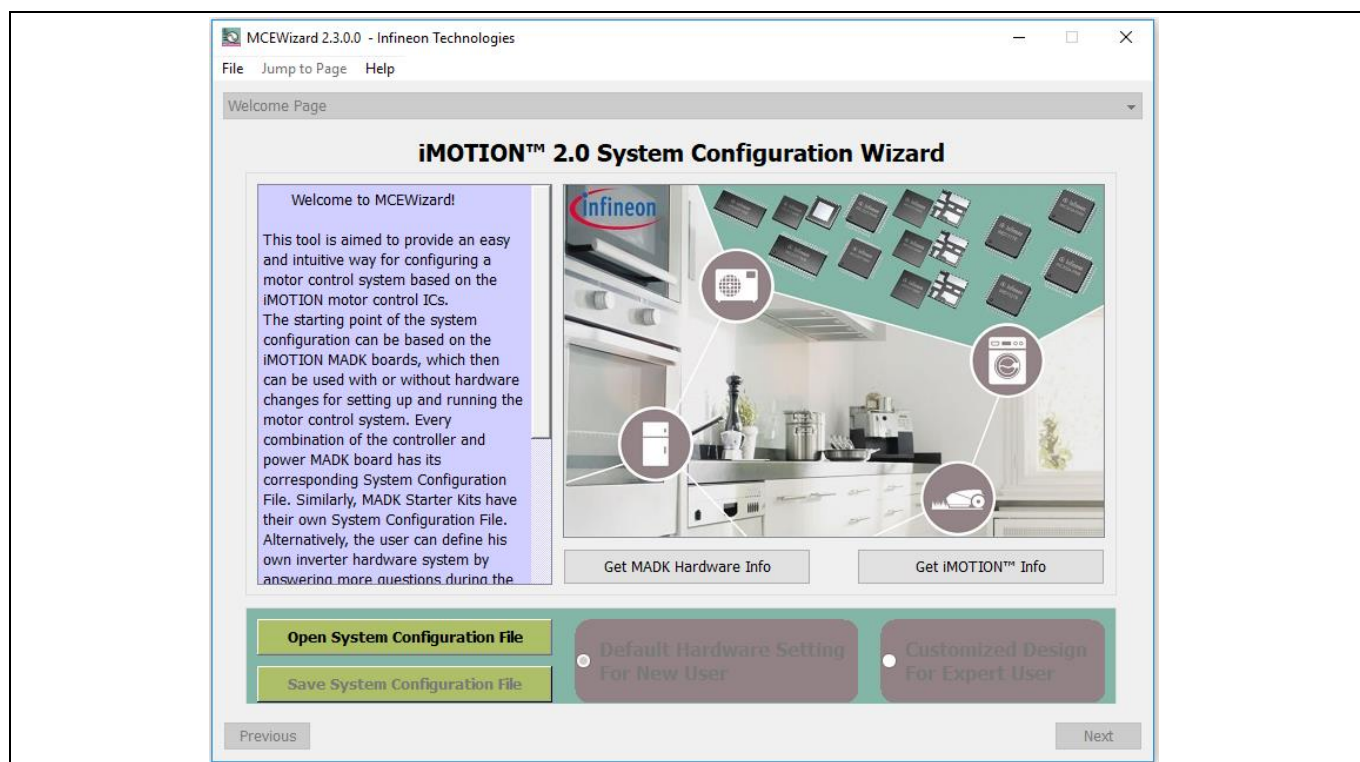

Figure 5 Welcome page of MCEWizard

For a new user, suggest using this evaluation board initially with a released MADK power board, as they always have a tested parameter file available on the MADK website. The default power board in this user guide is EVAL-M1-05-65D as shown in Figure 5.

The iMOTION™ MADK system enables users to easily test different combinations of control and power boards with their motors. The user should be familiar with the system-level parameters related to the motor used. There is a very limited number of parameters that are specific to the control board or power board hardware. Table 3 provides the MCEWizard setup overview for hardware-related parameters. Similar tables will be available in the User Guide of the specific power board. Combinations of this table and the corresponding table of the power board provides sufficient information to set up the MADK-based motor drive system in the shortest time.

Table 3 MCEWizard setup overview table

Parameter	Value	Comment
Power board selecting	MADK power board name	If no, select similar power board to modify
Motor 1 shunt configuration	Refer to the power board App Note	
Controller supply voltage	Refer to the power board App Note	VDD is 3.3 V by default
Max DC bus voltage	Refer to the power board App Note	
DC bus sensing high resistor	Refer to the power board App Note	
DC bus sensing low resistor	13.3 kOhm	
NTC temperature shutdown value	Calculated as in Section 2.5.2	Refer to the power board App Note
GateSense low-side devices	Refer to the power board App Note	High is true by default
GateSense high-side devices	Refer to the power board App Note	High is true by default
Motor 1 Current input	Calculated as the Section 2.4.2	

To start the MCEWizard system setup procedure, click the “Next” button in the right bottom corner as shown in Figure 6.

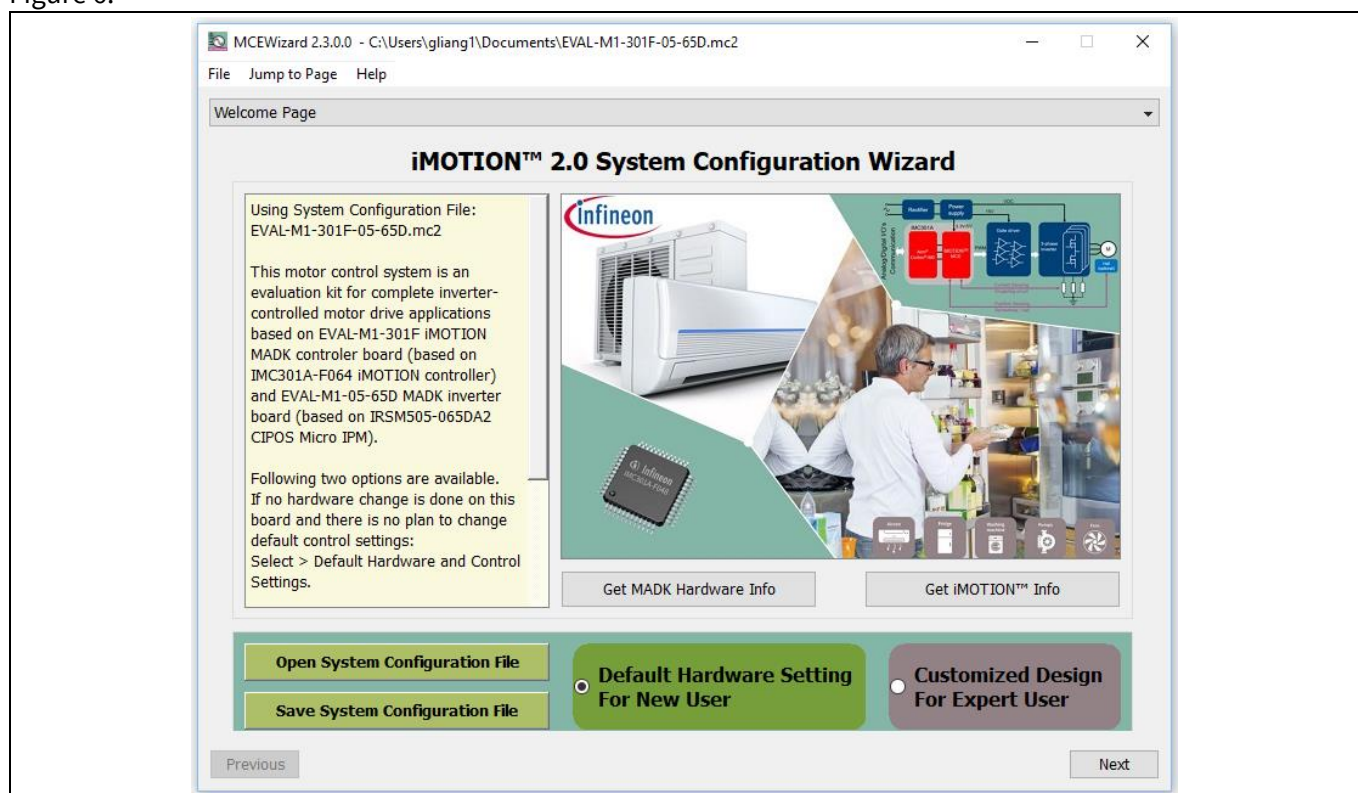

Figure 6 Opening the default configuration file of this board

After all the MCEWizard questions are answered, the “Verify & Save Page” will be shown as in Figure 7.

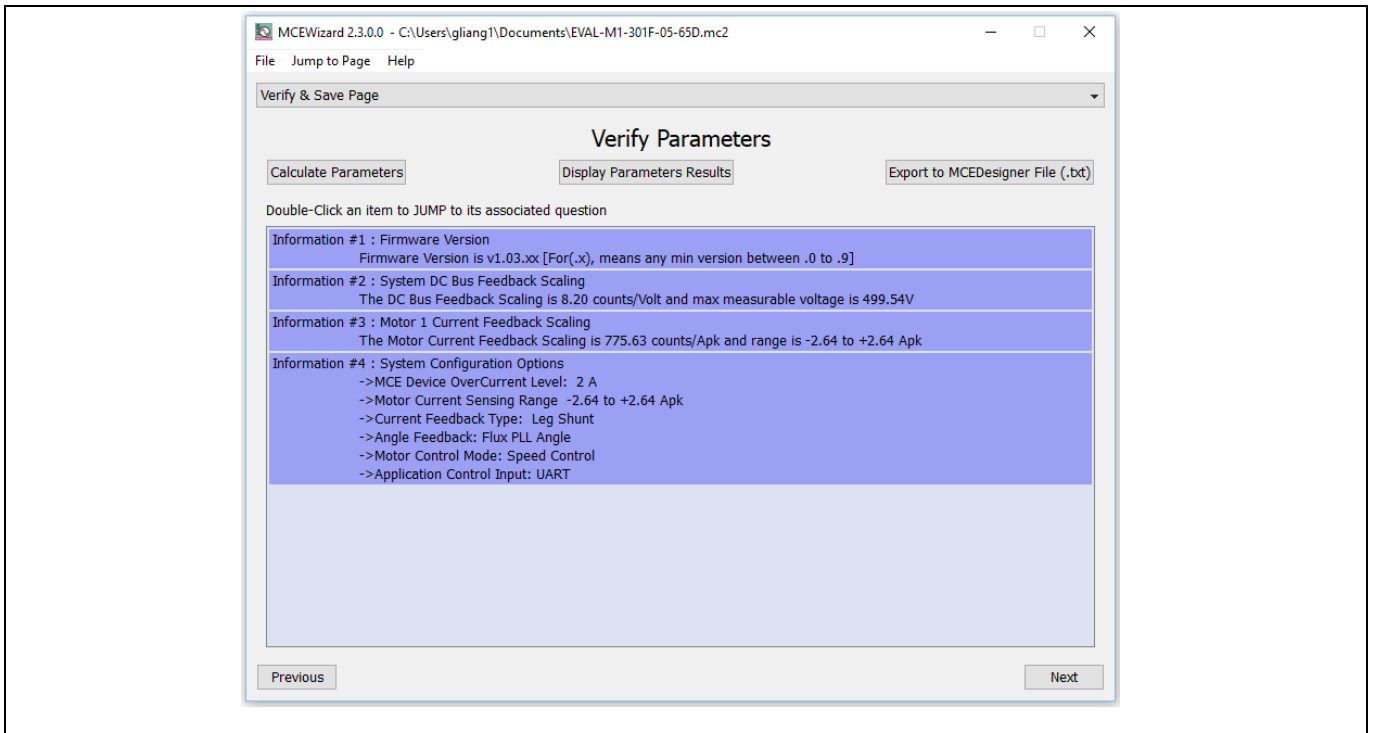

Figure 7 “Verify and Save” page for MCEWizard

Click “Calculate” button and “Export to Designer File (.txt)” button to save the parameter file that will be used by the MCEDesigner in the next steps.

2.2.2 MCEDesigner setup overview

After installing the MCEDesigner installer, there is a shortcut for MCEDesigner on the Windows desktop. Double click on the shortcut to open MCEDesigner and then open “IMC101T_xx.irc” file (which was included in the “IMC101T-F048 MCE Software Package” installed earlier, as instructed in Chapter 2.2) shown in Figure 8.

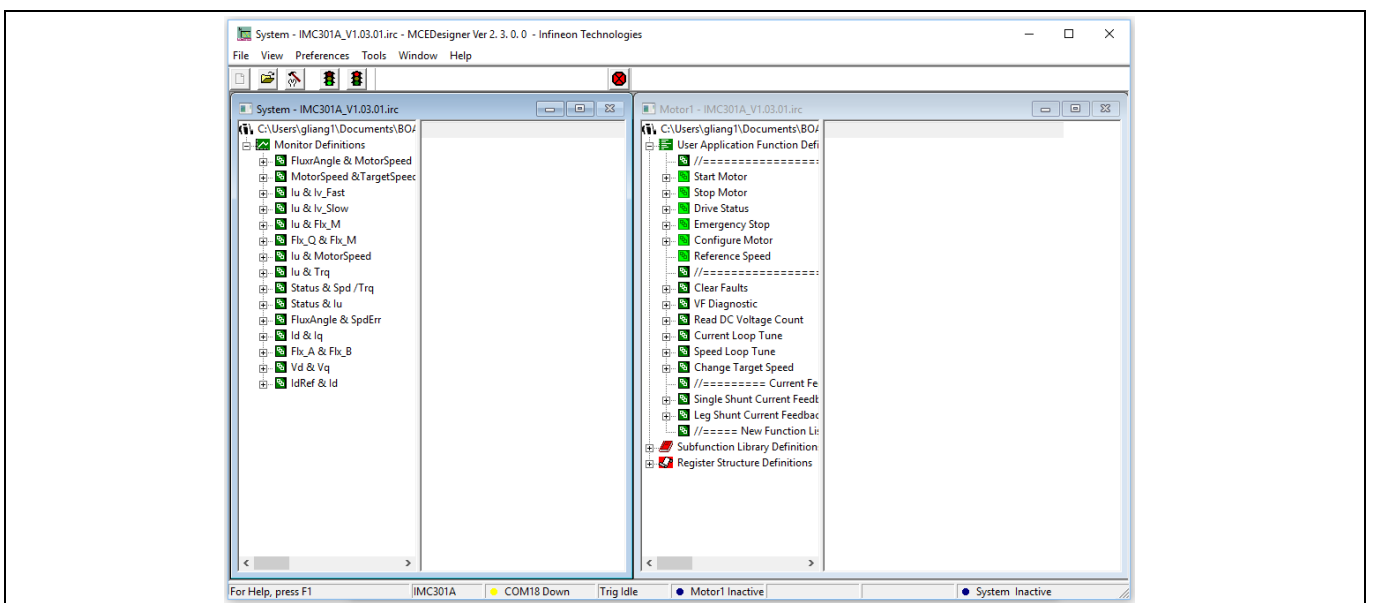

Figure 8 MCEDesigner’s main display for EVAL-M1-101TF

System and functional description

MCEDesigner programmer function can be used to program IMC101T-F048 firmware and/or system parameters. To call up this function, click on the “Tools” menu and then select “Programmer” in the pull-down list. The pop-up window “Program IMC controller” will show up as in Figure 9.

To program both firmware and drive system parameters in IMC101T-F048 (which can happen when programming the brand-new devices with default factory settings for the first time, or when the new version of iMOTION™ firmware is being downloaded), first click on the “Program Firmware and Parameter” radio button in the “Program IMC controller” pop-up window. After that, select the “Drive System Parameter” file created using MCEWizard by clicking on the “Browse...” button at the end of the “Program Parameter File” row, and then also select the IMC101T-F048_A_Vxxx.ldf file (which was included in the “IMC101T-F048 MCE Software Package”) by clicking on the “Browse...” button at the end of “Program Firmware File” row. Finally, click on the “Start” button to program the parameter file into the IMC101T-F048 IC.

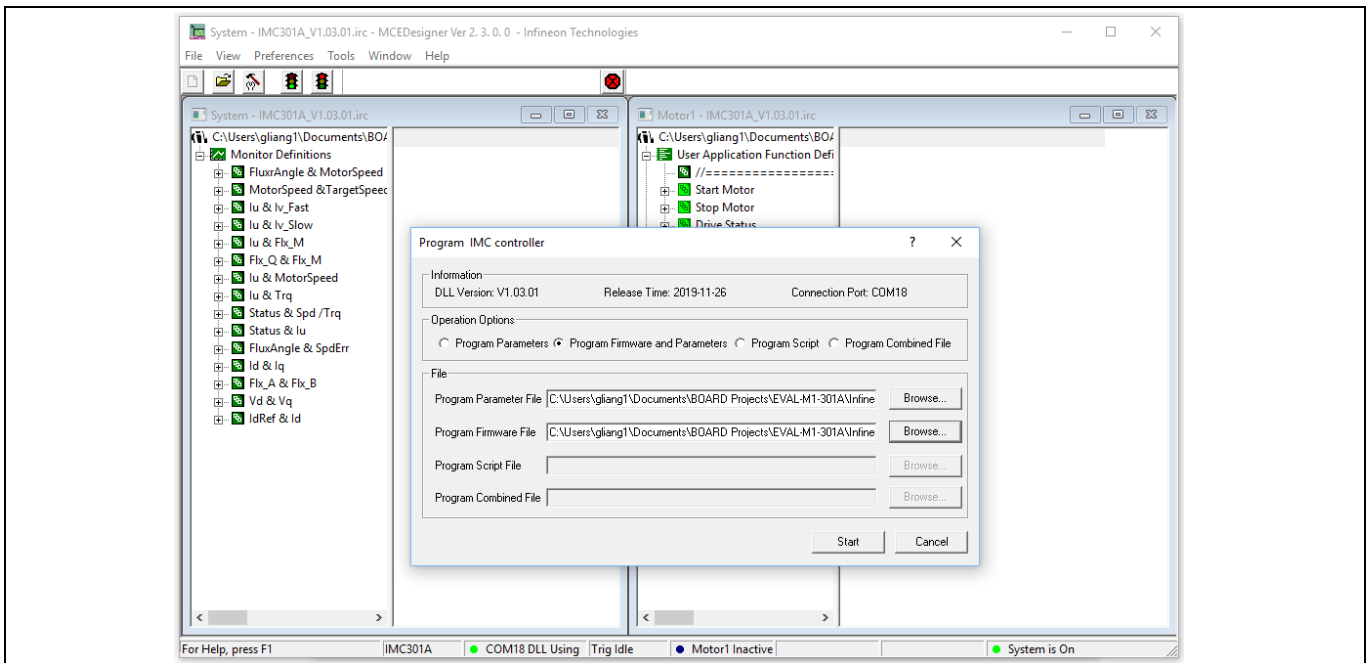

Figure 9 Program firmware and parameters in “Program IMC Controller” pop-up window

To program only “Drive System Parameter” file into IMC101T-F048, click on the “Tools” menu and select “Programmer” in the pull-down list. The pop-up window “Program IMC controller” will show up as in Figure 10. Click on the “Program Parameters” button (this is the default option), and then select the “Drive System Parameter” file created using MCEWizard by clicking on “Browse....” Finally, click on the “Start” button to program the parameter file into the IMC101T-F048 IC.

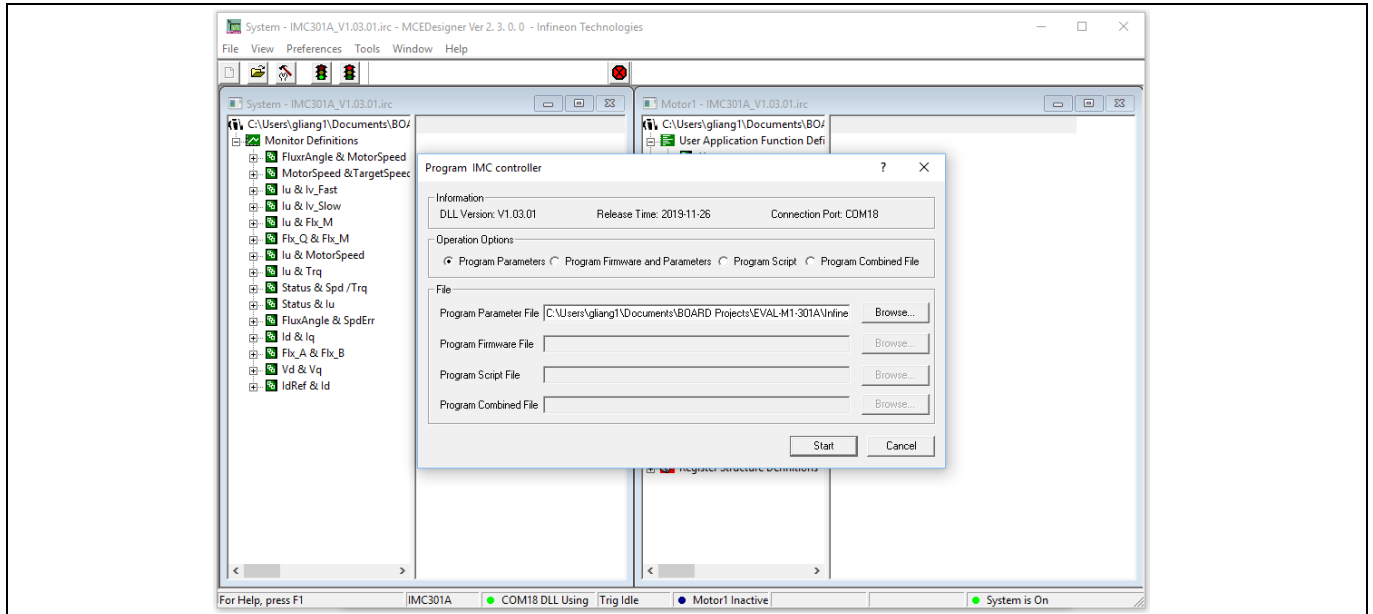

Figure 10 “Program IMC Controller” pop-up window

After the “Drive System Parameter” file has been programmed into the IMC101T controller, and the motor drive system is powered, the MCEDesigner can be used to start/stop the motor, display motor current traces, change the motor speed, modify drive parameters, and many other functions. Please refer to the MCEDesigner documentation for more details.

Note: The on-board debugger section of EVAL-M1-101TF is galvanically isolated from the controller section and the attached power board. In order to program the parameters or firmware to the IMC101T-F048 controller, the 3.3 V DC voltage needs to be supplied to the controller portion of the EVAL-M1-101TF. This voltage can either be supplied by the power board (MADK power boards are designed to supply the 3.3 V to the control board through M1 or M3 connector) or by feeding the 3.3 V DC voltage to the control board through some of the available 3.3 V access/test points, if the power board is not attached to the EVAL-M1-101TF control board.

All the latest firmware files for different types of iMOTION™ control ICs are available for download via the Infineon iMOTION™ website (<http://www.infineon.com/imotion-software>).

System and functional description

2.3 Description of the functional blocks

This chapter covers the hardware design of the EVAL-M1-101TF in more detail. To enable users to make the EVAL-M1-101TF evaluation board a basis for a new development or modification of their own systems, all necessary technical data such as schematics, layout and components are also included in this chapter. Again, please note that for almost all combinations of MADK controller boards and power boards, the configuration files can be downloaded from the Infineon website.

2.4 Motor current feedback circuitry

2.4.1 Motor shunt configuration

Both single shunt and leg shunt topologies are supported by the EVAL-M1-101TF control board. The user needs to ensure that the shunt configuration matches the power board hardware configuration. Please refer to the power board User Guide for details. The shunt configuration can be changed in the option page as shown in Figure 11.

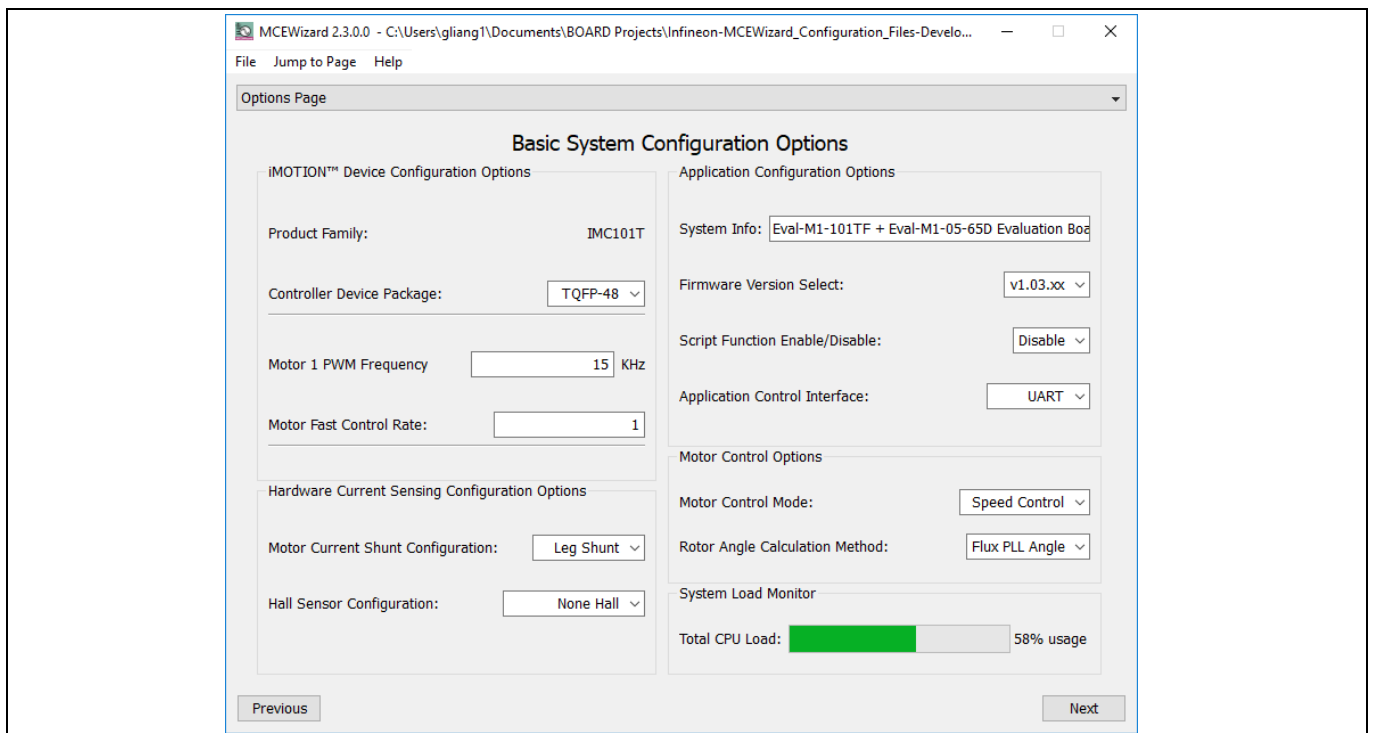

Figure 11 Shunt configuration

2.4.2 Motor external current feedback configuration and calculation

The shunt resistance R_{sh} value can be found in the schematics or User Guide for the power board (for example, the leg shunt resistors are 250mΩ for EVAL-M1-05-065D).

System and functional description

The current input value is a product of the shunt resistance in milliohms and gain of external current sense amplifier as shown in Figure 12.

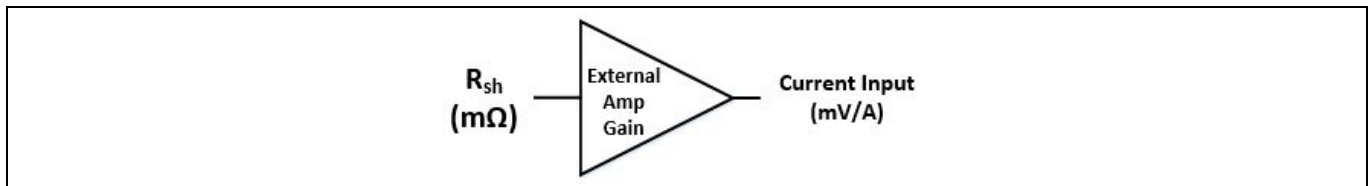

Figure 12 Current shunt feedback and sample timing

Figure 13 depicts IU+ current feedback sensing circuitry on EVAL-M1-101TF evaluation board. Please note that the default external amplification gain is less than 1 for current sense in this evaluation board.

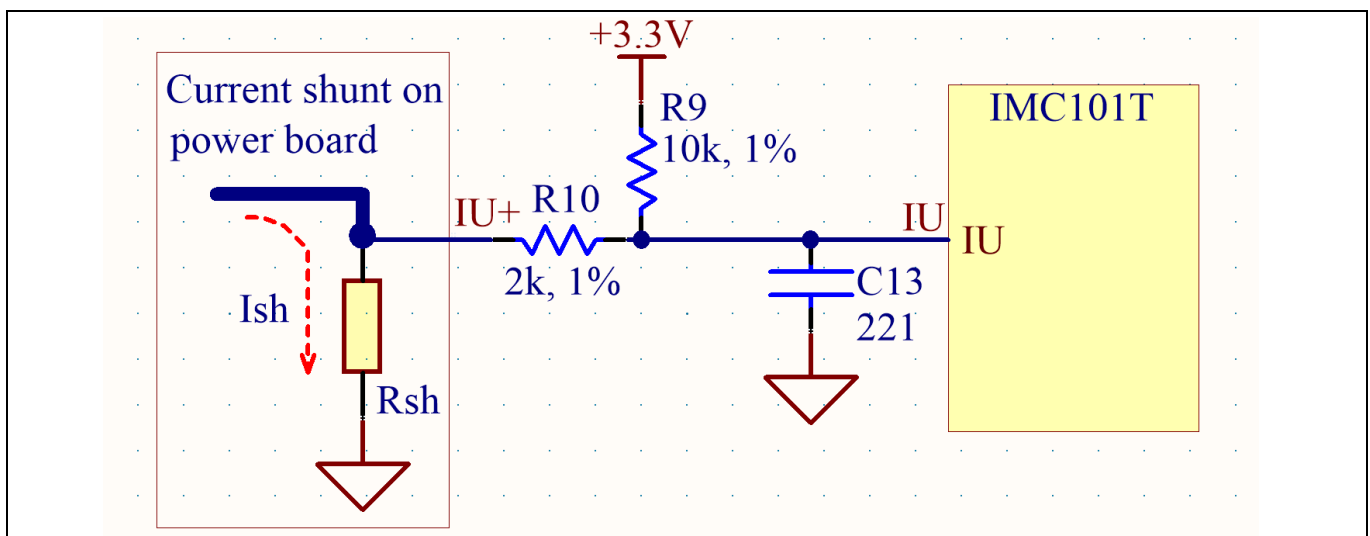

Figure 13 The current feedback section on the EVAL-M1-101TF evaluation board

Based on the principle of Kirchhoff's voltage law,

$$V_2 \approx V_1 \approx (V_{DD} - I_{sh} * R_{sh}) * \frac{R_{13}}{R_{10} + R_{13}} + I_{sh} * R_{sh} = \frac{R_{13}}{R_{10} + R_{13}} V_{DD} + \frac{R_{10}}{R_{10} + R_{13}} R_{sh} * I_{sh}$$

$$\text{Current input} = \frac{R_{10}}{R_{10} + R_{13}} R_{sh} = \frac{5}{6} R_{sh}$$

Rsh in EVAL-M1-05-065D is 250 mΩ, based on this calculation, the current input for the MADK combination of EVAL-M1-301F and EVAL-M1-05-065D is 208.3 mV/A. Please use same procedure to calculate the current input for other combinations of MADK boards and enter it into MCEWizard.

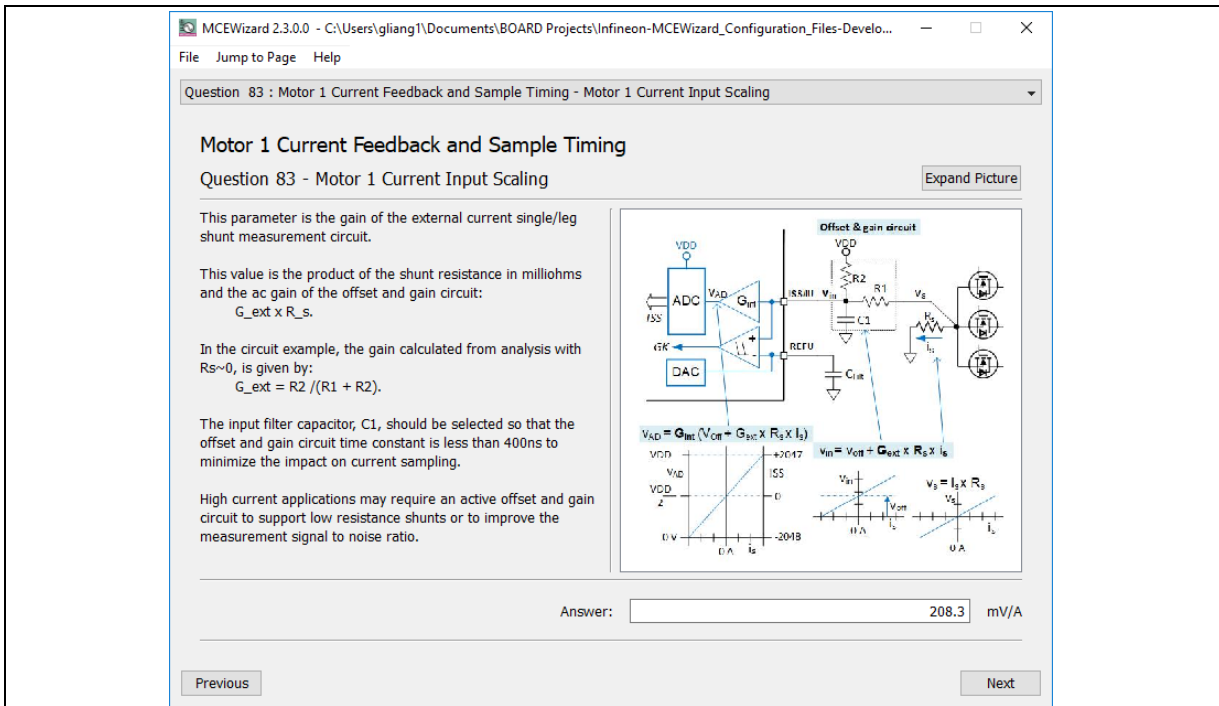

Figure 14 Current feedback configuration in MCEWizard for EVAL-M1-101TF and EVAL-M1-05-065D

2.4.3 Motor internal current feedback amplifier gain configuration

For the current feedback, the iMOTION™ controller on this board has the internal amplifier which has four programmable gain settings: 1x, 3x, 6x and 12x.

The internal current-feedback amplifier gain can be configured in MCEWizard as shown in Figure 15.

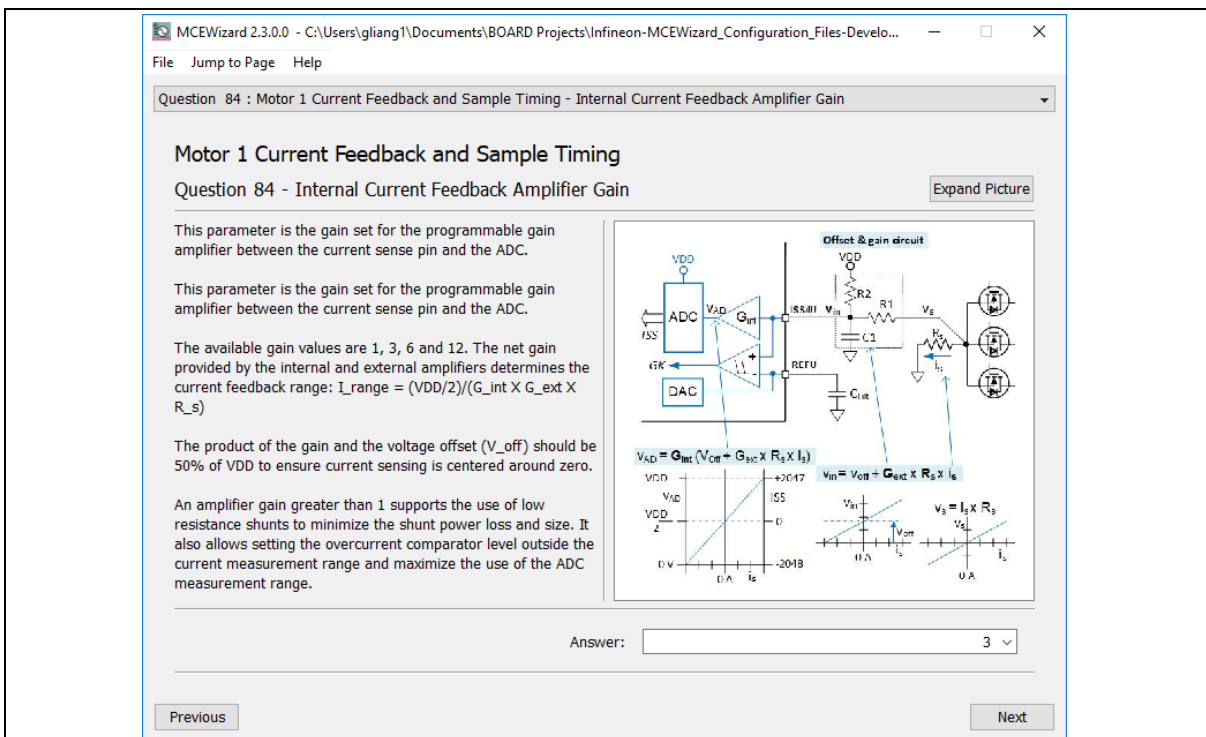

Figure 15 Internal current-feedback amplifier-gain configuration

2.5 EVAL-M1-101TF analog inputs and their MCEWizard setup

Besides current-sensing inputs, IMC101T-F048 provides a number of analog inputs for different system functions. Figure 16 depicts the analog inputs of the IMC101T-F048 except for the current-sensing inputs.

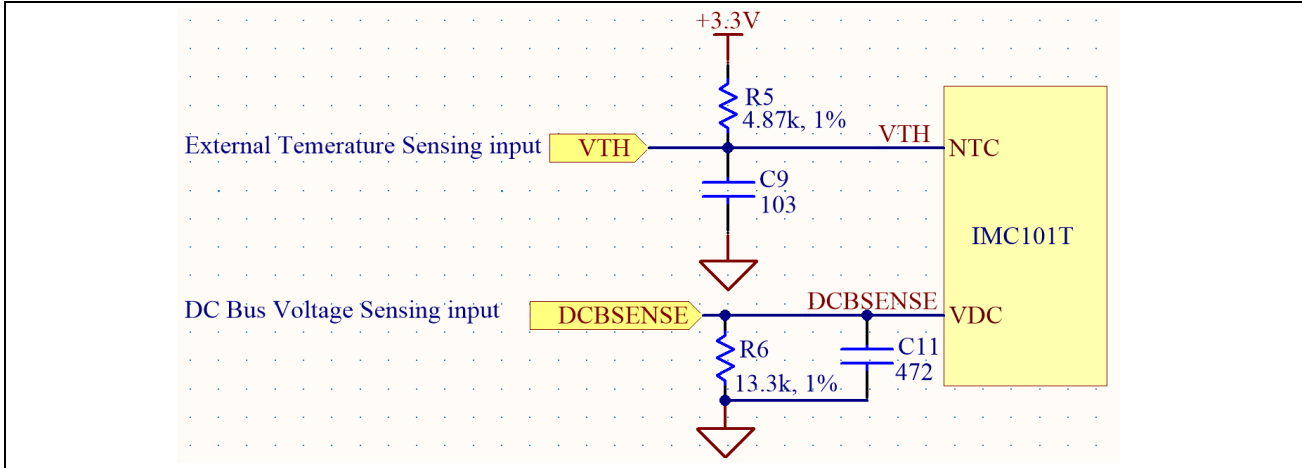

Figure 16 Analog inputs on the EVAL-M1-101TF evaluation board

2.5.1 DC bus-sensing configuration

The low-side resistor R4 for the DC bus-sensing resistor divider on the controller board EVAL-M1-101TF is 13.3 kΩ, and should be configured in MCEWizard as shown in Figure 17. For the high-side resistor value, please refer to the User Guide of the corresponding power board.

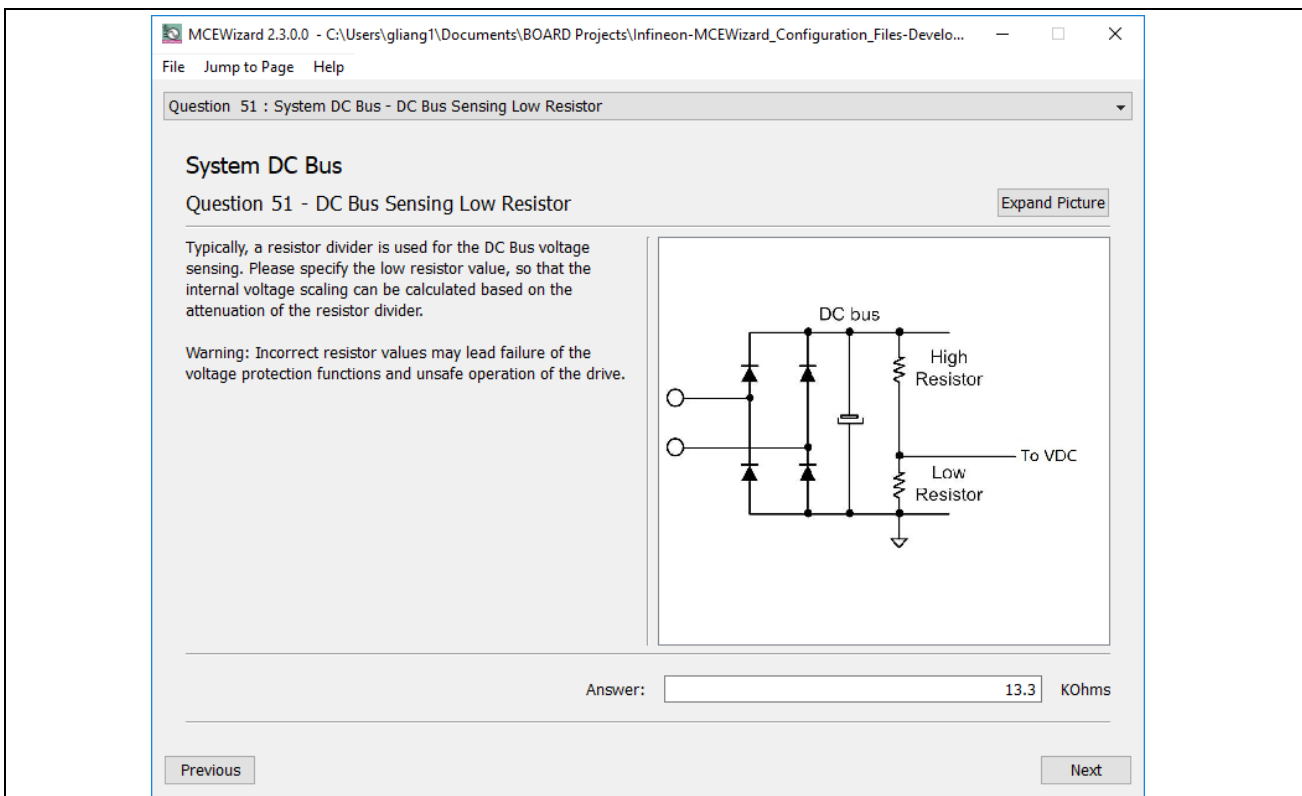

Figure 17 DC bus-sensing configuration in MCEWizard

2.5.2 NTC shutdown value calculation and configuration

External NTC temperature shutdown values can be calculated as shown below and configured in MCEWizard as shown in Figure 18. For the pull-up resistor on the evaluation power board and the NTC value, please refer to the power board’s User Guide. The value of the pull-up resistor on EVAL-M1-101TF is 4.87 kΩ (see Figure 16).

$$R_{total\ pull-up} = \frac{R_{pull-up\ on\ Control\ board} * R_{pull-up\ on\ Power\ board}}{R_{pull-up\ on\ Control\ board} + R_{pull-up\ on\ Power\ board}}$$

$$V_{shut\ down} = \frac{R_{NTC@setting\ temperature}}{R_{NTC@setting\ temperature} + R_{total\ pull-up}} V_{DD}$$

The typical value of R_{NTC} at 100°C is 2.9 kΩ for the IPM IRSM505-065DA that is used in EVAL-M1-05-065D. If the setting temperature is 100°C, the shutdown value should be 1.24 V.

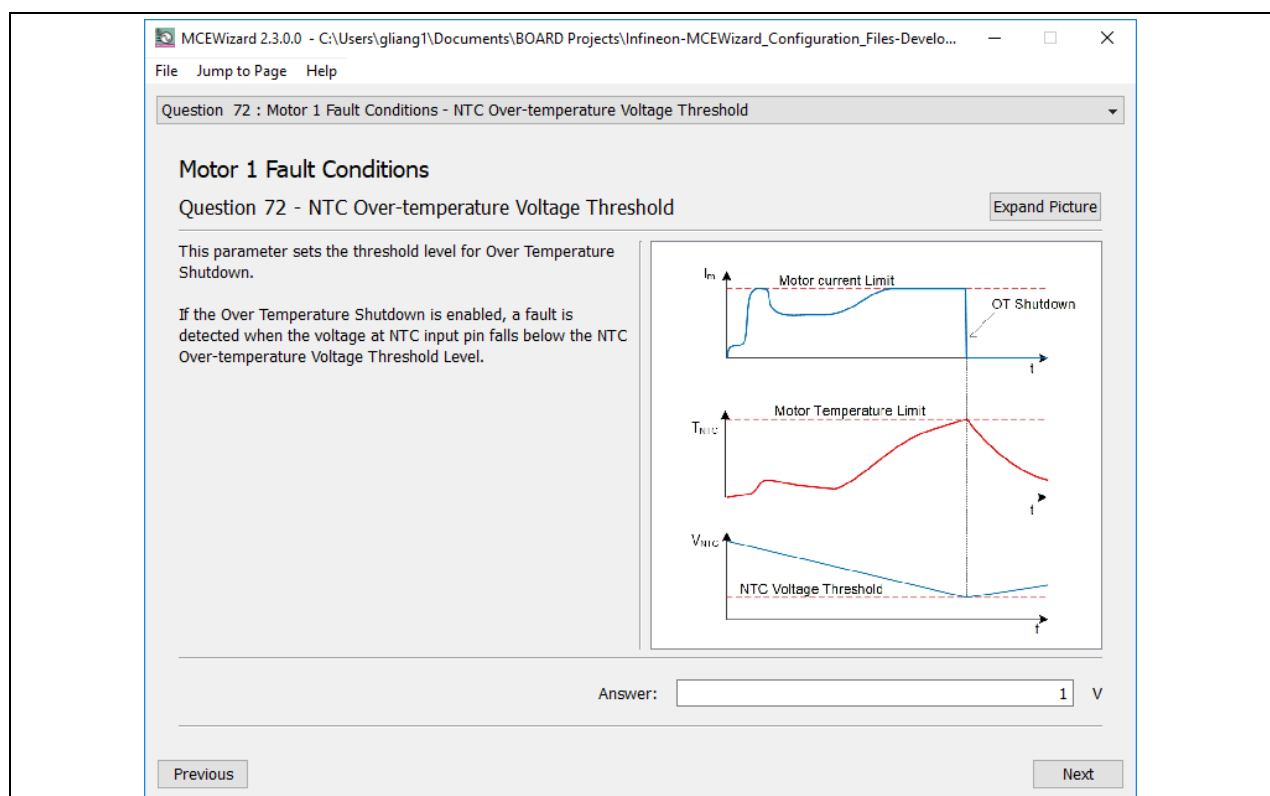

Figure 18 External temperature-sensing input configuration in MCEWizard

2.5.3 VSP analog input control mode and PGOUT configuration

The VSP analog input control mode can be configured in the options page for the MCEWizard by clicking and selecting in the pull-down list marked with a red box as shown in Figure 19.

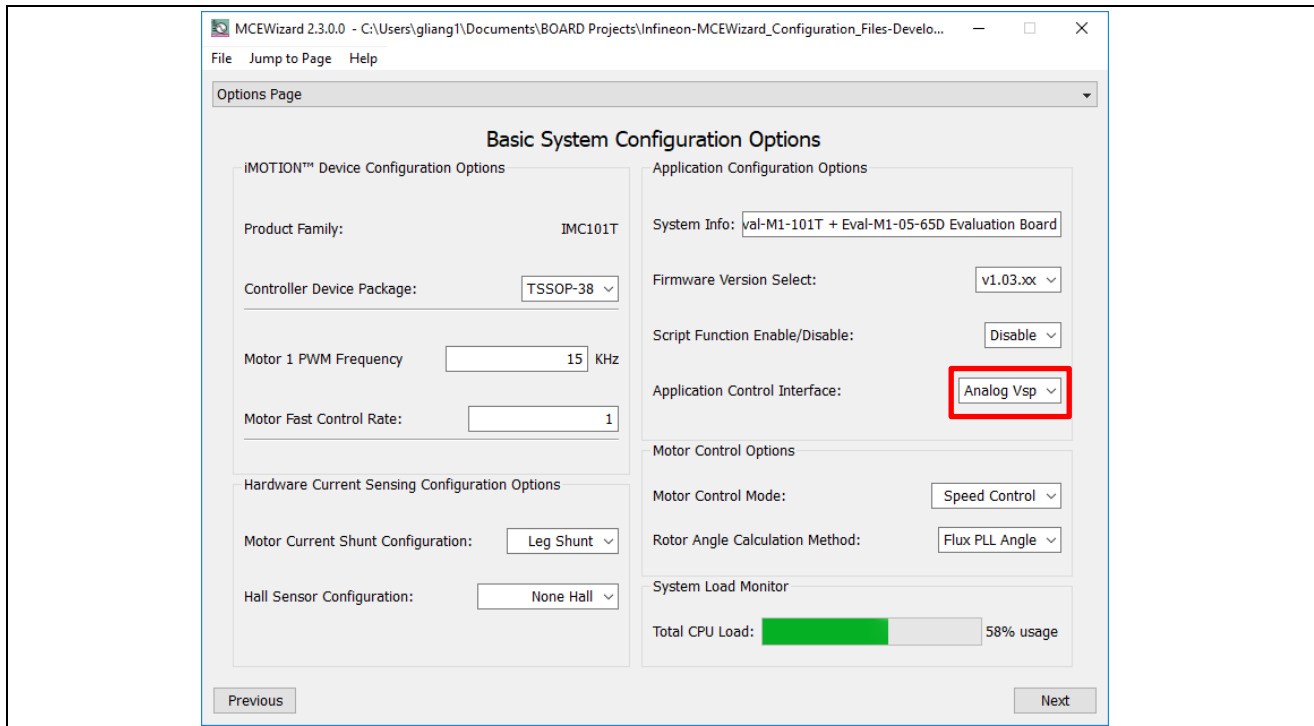

Figure 19 Analog VSP control input mode configuration

Figure 20 explains that there are three input thresholds (percentage of controller supply voltage VDD) that are used to define the relationship between the Vsp input voltage and the “TargetSpeed”.

1. T1 (Input threshold for motor start): if the Vsp analog voltage is above this threshold, the motor will start
2. T2 (Input threshold for motor stop): if the Vsp analog voltage is below this threshold, the motor will stop
3. T3 (Input threshold for Max RPM): if the Vsp analog voltage is higher or equal to this threshold, the “TargetSpeed” will be 16384 which is the maximum speed (MaxRPM).

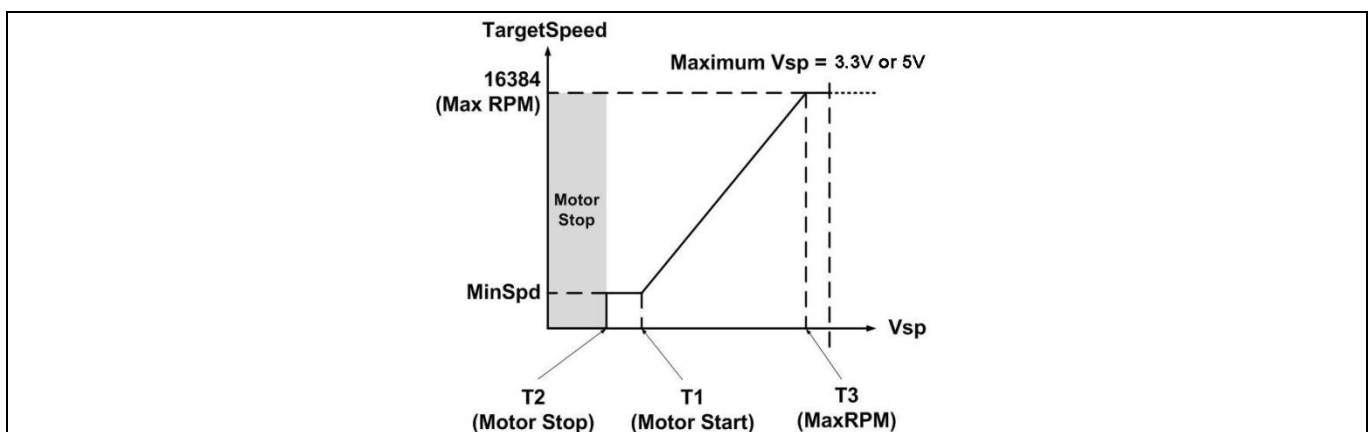

Figure 20 The relationship between VSP analog input voltage and TargetSpeed

After configuring the analog Vsp control input mode, the three input thresholds can be set up in the input text box in MCEWizard marked with a red box as shown in Figure 21, or in the pages for Question of T1, Question of T2 and Question of T3.

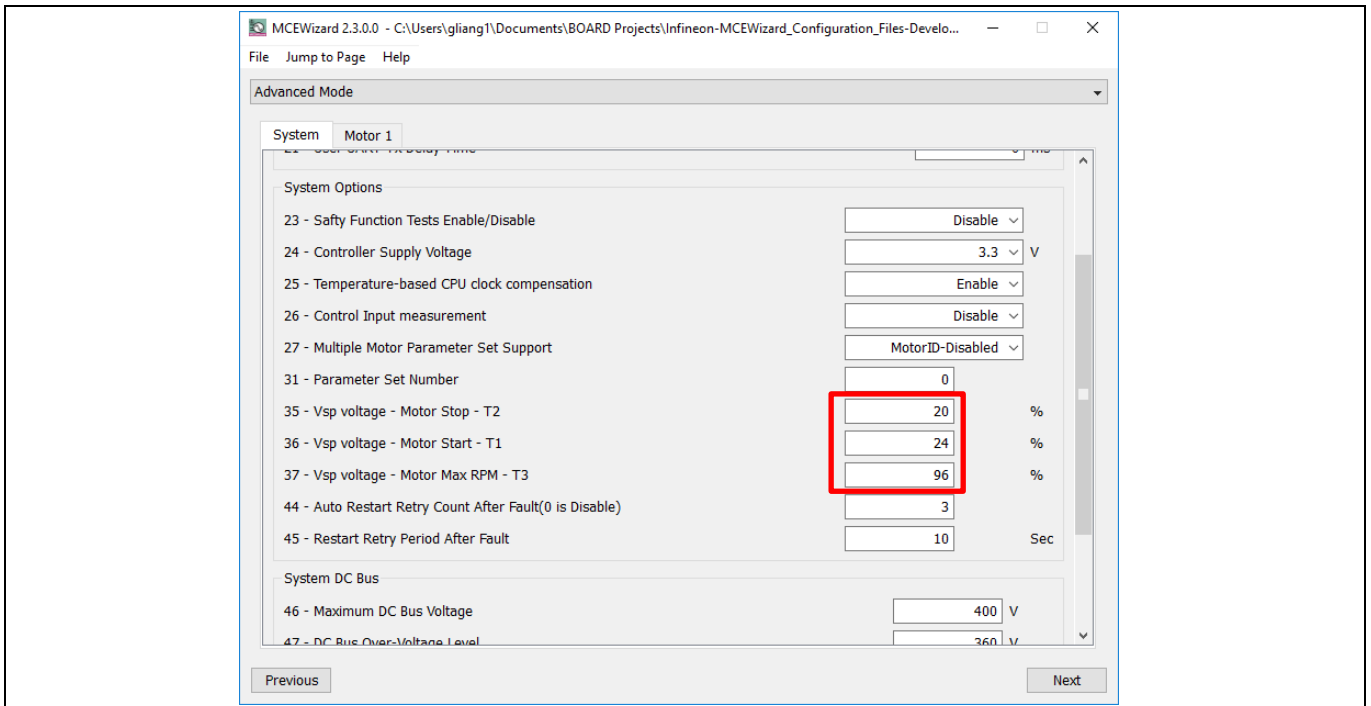

Figure 21 Three input thresholds configuration for VSP analog input control mode

For analog Vsp control input mode, the motor speed can be calculated by measuring the frequency of PGOUT signal output of control IC IMC101T-F048. And the pulse generation number per revolution of the motor can be configured in MCEWizard as shown in Figure 22.

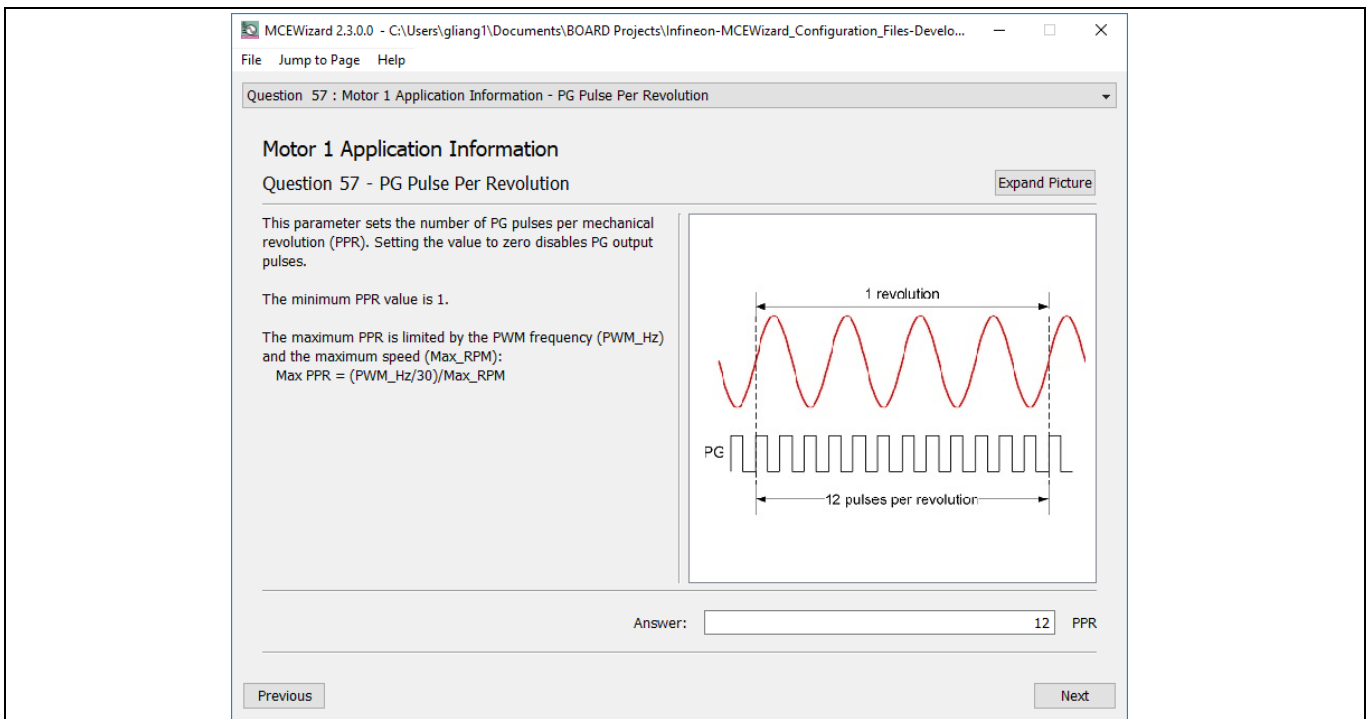

Figure 22 PG pulse per revolution configuration

Motor speed can be calculated as shown below.

EVAL-M1-101TF user guide
iMOTION™ Modular Application Design Kit
System and functional description

$$Motor\ speed(RPM) = \frac{PGOUT\ Frequency(Hz) * 60s}{Pulse\ Per\ Revolution}$$

For example, the PGOUT frequency is about 80 Hz and the pulse per revolution is 6, the motor speed will then be 800 RPM.

By default, VDD is 3.3V for the EVAL-M1-101T. The input of Vsp and PGOUT (pulse generation output) should be limited within the voltage range of 0 and 3.3V. While for some application, PGOUT should be connected to speed measurement circuit. The evaluation board EVAL-M1-101T provides FG (Frequency Generation) signal with an open drain structure controlled by PGOUT as shown in Figure 23. And FG signal can be pull up to 30V.

The frequency of FG is the same as PGOUT, and the calculation equation for motor speed is the same.

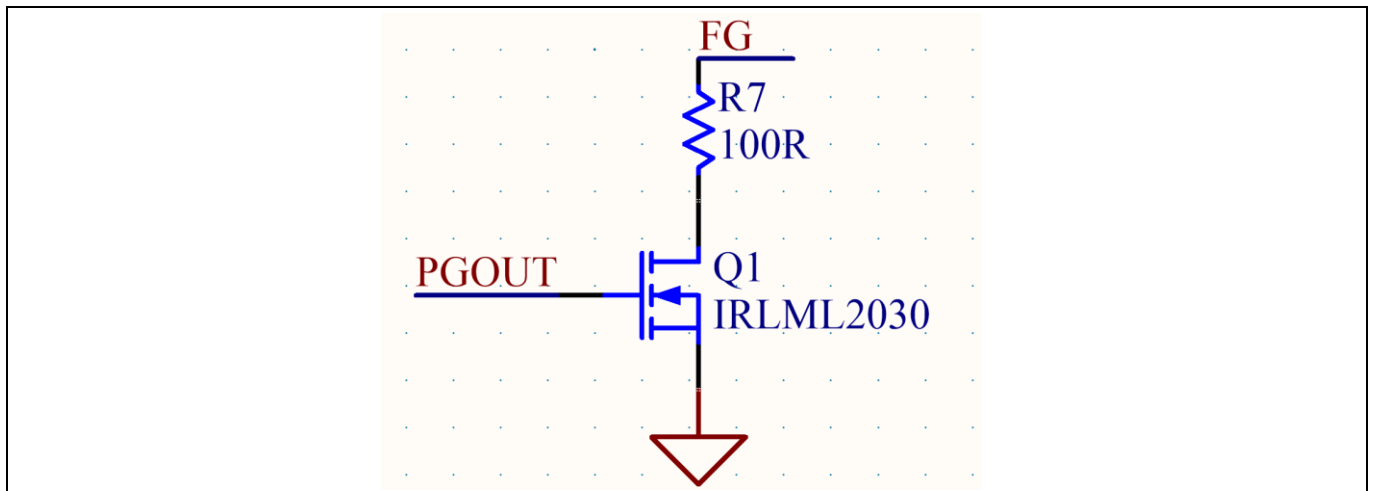

Figure 23 VSP Input Connector and level shift schematic for FG

System design

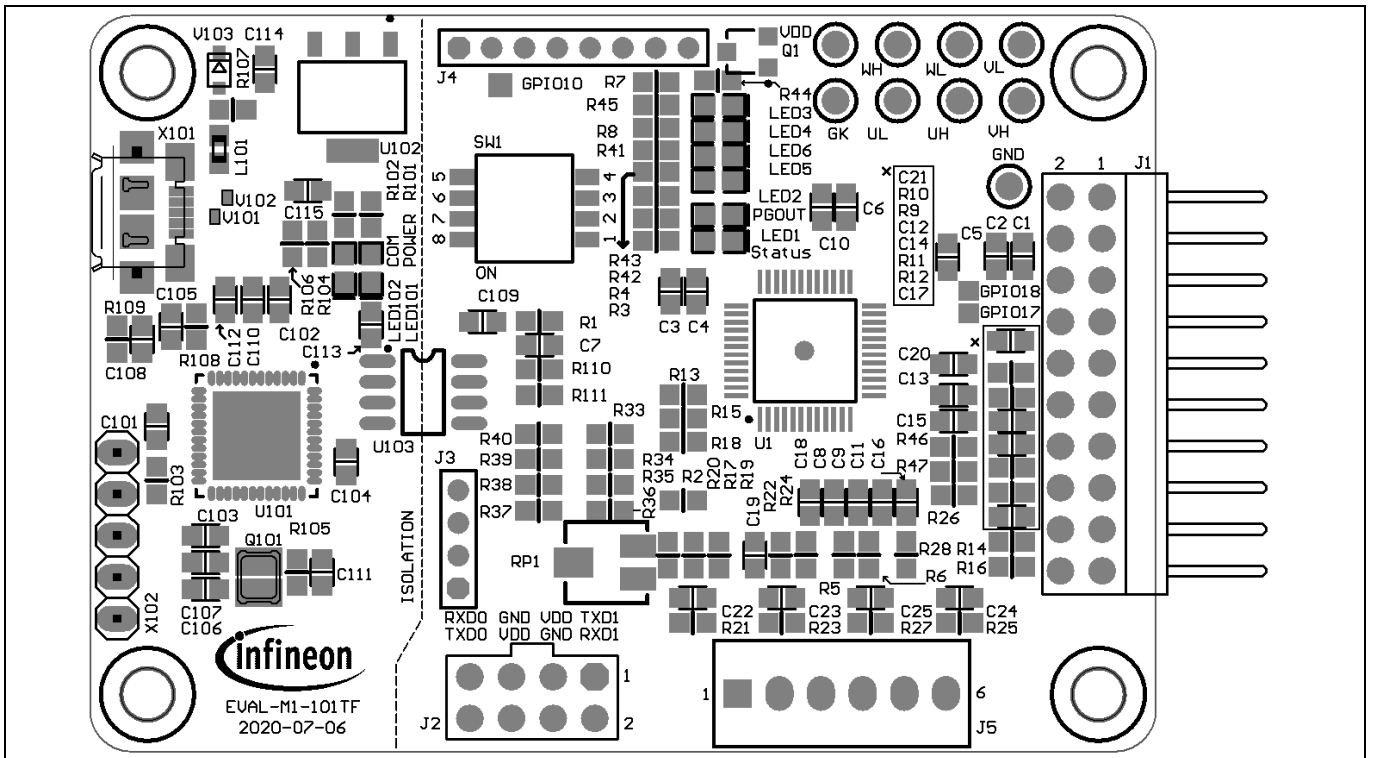

Figure 25 Top overlay print of the EVAL-M1-101TF evaluation board

Figure 26 depicts the bottom assembly print of the evaluation board.

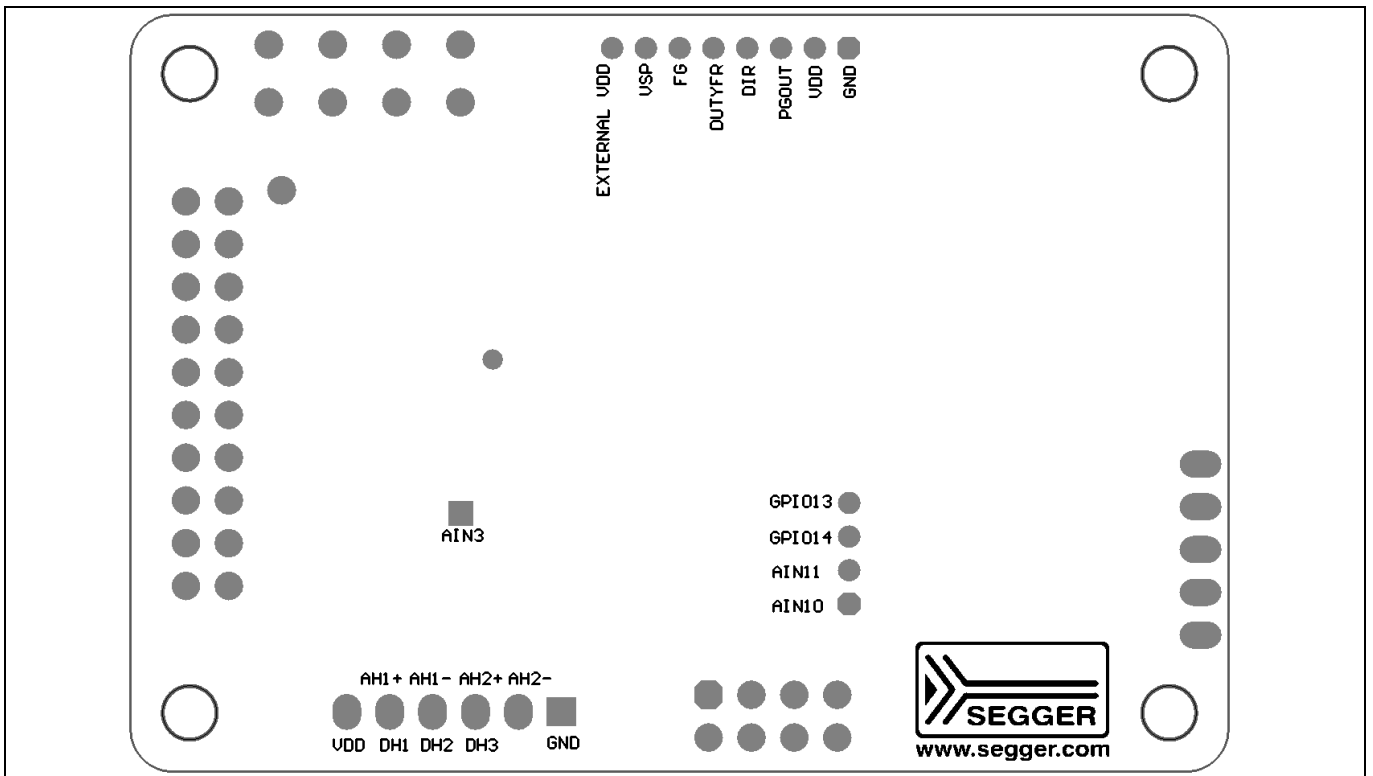

Figure 26 Bottom overlay print of the EVAL-M1-101TF evaluation board

The top layer routing of the PCB is provided in the following Figure 27.

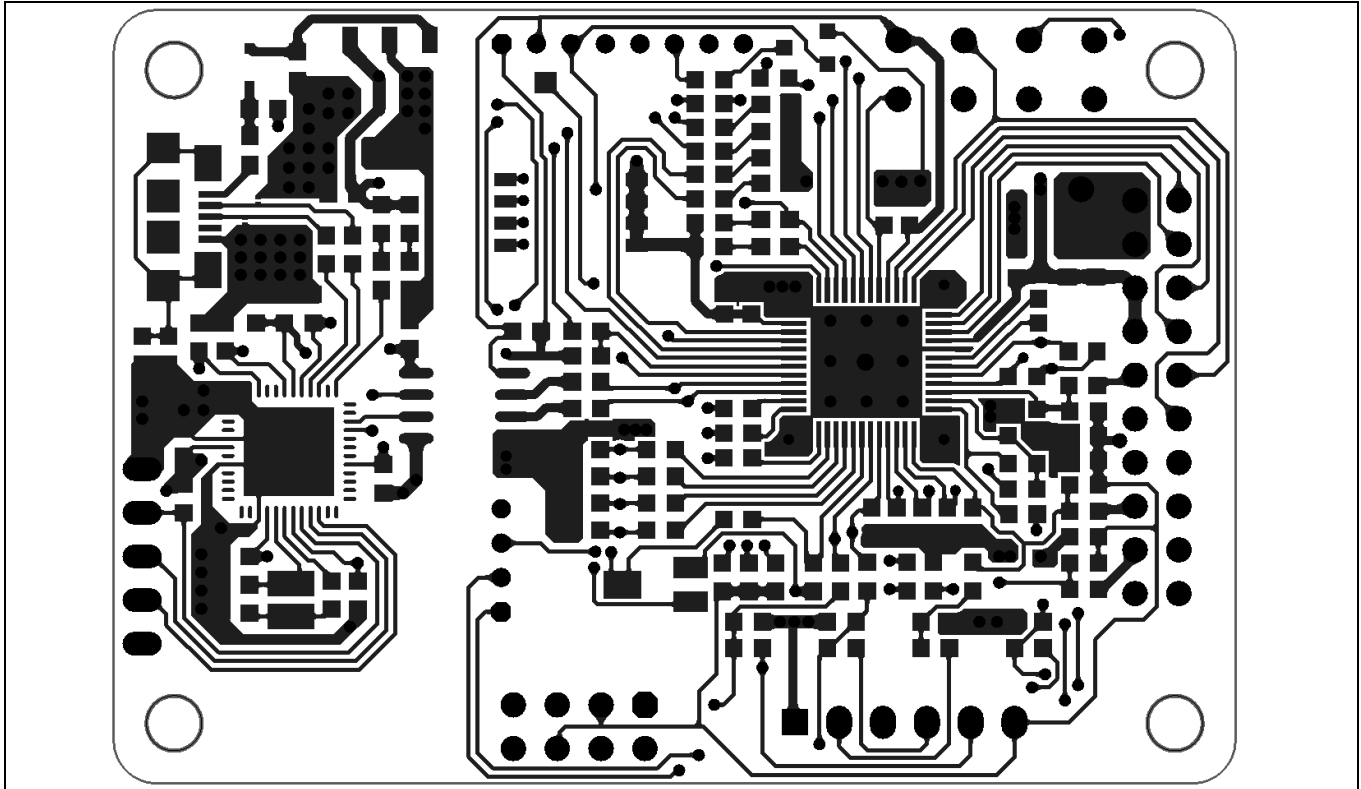

Figure 27 Top layer routing of the EVAL-M1-101TF

Figure 28 illustrates the bottom layer routing of the PCB.

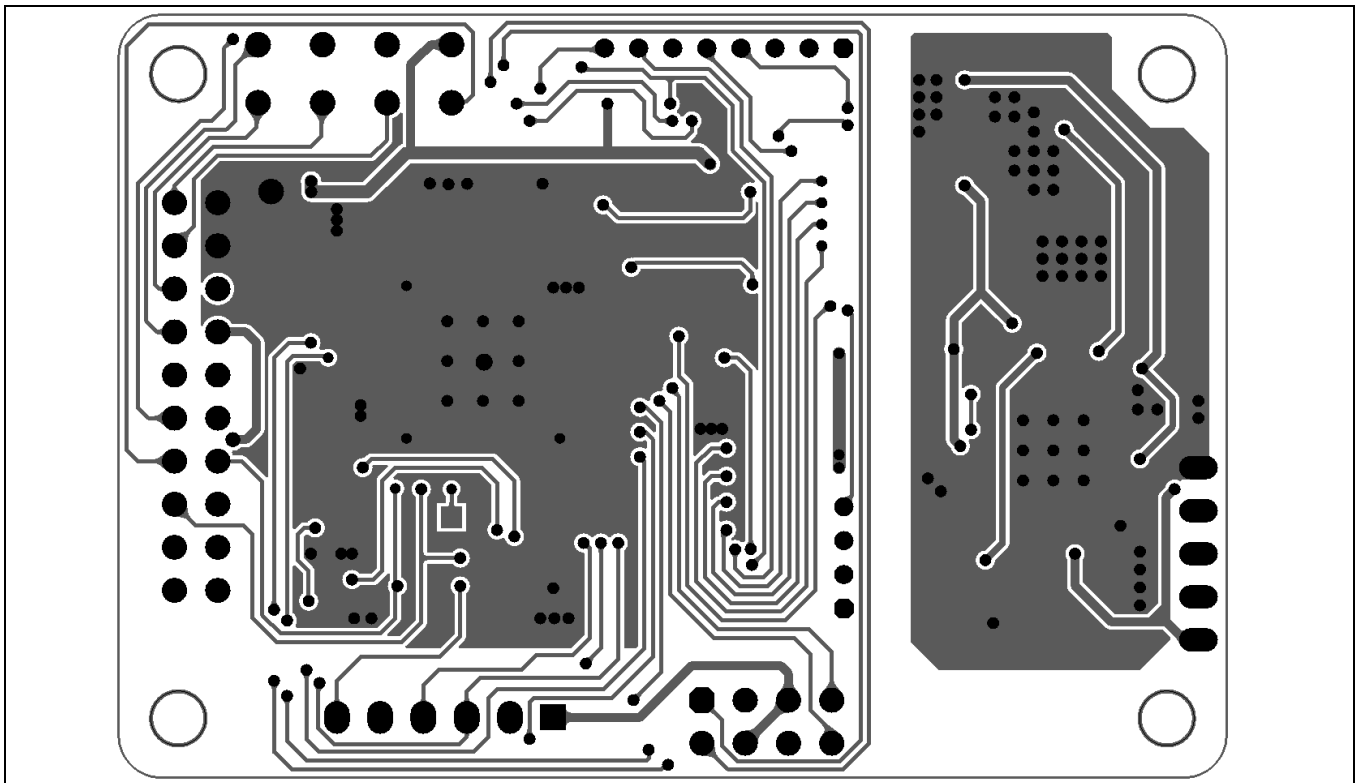

Figure 28 Bottom layer routing of the EVAL-M1-101TF

Bill of materials

4 Bill of materials

This evaluation design kit provides the complete bill of materials for the EVAL-M1-101TF board. The complete bill of material is available on the download section of the Infineon homepage. A log-in is required to download this material. Some key components are shown on **Error! Reference source not found..**

Table 4 Key components list

No.	Qty.	Part description	Designator	Part number	Manufacturer
1	1	CAP SMD 10uF 16V 0805	C1	885012206014	Wurth Electronics Inc.
42	1	LED BLUE CLEAR 0603 SMD	LED103	150060BS75000	Wurth Electronics Inc.
45	1	IC MCU 32BIT 128KB FLASH LQFP64	U1	IMC101T-F048	Infineon Technology
46	1	IC MCU 32BIT 256KB FLASH 48VQFN	U101	XMC4200_QFN48	Infineon Technology
47	1	IC REG LINEAR 3.3V 1A SOT223-4	U102	IFX25001ME V33	Infineon Technology
50	2	TVS DIODE 17VC WLL-2-1	V101, V102	ESD237-B1-W0201	Infineon Technology
51	1	DIODE SCHOTTKY 30V 1A SOD323-2	V103	BAS3010A-03W	Infineon Technology

Bill of materials

4.1 Connector details

Key information about the connections of the EVAL-M1-101TF evaluation board is described below.

Table 5 provides the pin assignments of the iMOTION™ MADK-M1 20-pins interface connector J1. This connector is the interface to the power board.

Table 5 J1- iMOTION™ MADK-M1 20 pin- interface connector for control board

Pin No.	Pin	Details
1	PWMUH	3.3 V compatible logic output for high side gate driver-Phase U
2	GND	Ground
3	PWMUL	3.3 V compatible logic output for low side gate driver-Phase U
4	GND	Ground
5	PWMVH	3.3 V compatible logic output for high side gate driver-Phase V
6	+3.3V	On board 3.3 V supply
7	PWMVL	3.3 V compatible logic output for low side gate driver-Phase V
8	+3.3V	On board 3.3 V supply
9	PWMWH	3.3 V compatible logic output for high side gate driver-Phase W
10	IU+	Shunt voltage phase U
11	PWMWL	3.3 V compatible logic output for low side gate driver-Phase W
12	IU-	Ground
13	GK	Gatekill signal – active low when overcurrent is detected
14	DCBSENSE	DC bus positive voltage, scaled in 0-3.3 V range by a voltage divider
15	VTH	Thermistor input
16	IV+	Shunt voltage phase V
17	IV-	Ground
18	IW+	Shunt voltage phase W
19	IW-	Ground
20	VCC	Defined for 15 V power supply (not used in this board)

J2 is the interface to iMOTION Link, the MCE debugger cable, for downloading code and parameter. Please be noted, normally user use the on-board debugger other than an additional iMOTION Link. J4 is an interface for some special mode speed reference requirement, especially for fan application.

Table 6 J2- iMOTION Link

Pin	Name	Pin name connector
1	TXD1	User serial debug clock for MCU
2	RXD1	User serial debug I/O for MCU
3	VDD	+3.3 V power supply
4	GND	Ground
5	GND	Ground
6	VDD	+3.3 V power supply
7	RXD0	Reception of UART0 for MCE
8	TXD0	Transmission of UART0 for MCE

Bill of materials

Table 7 J3- AIN & GPIO pins

Pin	Name	Pin name connector
1	AIN10	Analog input
2	AIN11	Analog input
3	GPIO15	User configurable I/O, digital
4	GPIO14	User configurable I/O, digital

Table 8 J4- Interface for fan

Pin	Name	Pin name connector
1	GND	Ground
2	VDD	+3.3 V power supply
3	PGOUT	Speed feedback signal from MCE
4	DIR	Direction
5	DUTYFREQ	Duty cycle / Frequency reference
6	FG	Speed feedback to external
7	VSP	Analog reference
8	External VDD	External power supply for FG signal

The EVAL-M1-101TF supports the use of both digital and analog Hall sensors. Table 9 includes the details of the Hall sensor interface connector.

Table 9 J5- Hall sensor Input

Pin	Name	Pin name connectors
1	GND	Ground
2	AH2-	Analog Hall sensor Input2-
3	DH3/AH2+	Digital Hall sensor Input3 or analog Hall sensor Input2+
4	DH2/AH1-	Digital Hall sensor Input2 or analog Hall sensor Input1-
5	DH1/AH1+	Digital Hall sensor Input1 or analog Hall sensor Input1+
6	VDD	+3.3 V power supply

There is a multi-channel switch assigned on this board for the parameter block selection. Mapping between parameter page selections based on GPIO pins are listed in the 0.

Bill of materials

Table 10 Parameter page selection for GPIO

GPIO input				Parameter block
PAR3	PAR2	PAR1	PAR0	
0	0	0	0	0
0	0	0	1	1
0	0	1	0	2
0	0	1	1	3
0	1	0	0	4
0	1	0	1	5
0	1	1	0	6
0	1	1	1	7
0	0	0	0	8
1	0	0	1	9
1	0	1	0	10
1	0	1	1	11
1	1	0	0	12
1	1	0	1	13
1	1	1	0	14
1	1	1	1	14

Table 11 list some LEDs on this board.

Table 11 Function of on-board LEDs

Name	Function
LED1	Status
LED2	PGOUT
LED3	GPIO8
LED4	GPIO9
LED5	GPIO11
LED6	GPIO12

5 References and appendices

5.1 References

- [1] Infineon-IMC100-DS-v01_05-EN.pdf
- [2] iMOTION™ MCE Software Reference Manual
- [3] MCEWizard User Guide
- [4] MCEDesigner User Guide

5.2 Ordering information

Base Part Number	Package	Standard Pack		Orderable Part Number
		Form	Quantity	
EVAL-M1-101TF	EVAL	Boxed	1	EVAL-M1-101TFTOBO1

Revision history

Revision history

Document version	Date of release	Description of changes
1.0	2020-11-03	First release

Trademarks

All referenced product or service names and trademarks are the property of their respective owners.

Edition 2020-11-03

Published by

Infineon Technologies AG

81726 Munich, Germany

© 2020 Infineon Technologies AG.

All Rights Reserved.

Do you have a question about this document?

Email: erratum@infineon.com

Document reference

UG2020-15

For further information on the product, technology, delivery terms and conditions and prices please contact your nearest Infineon Technologies office (www.infineon.com).

WARNINGS

Due to technical requirements products may contain dangerous substances. For information on the types in question please contact your nearest Infineon Technologies office.

Except as otherwise explicitly approved by Infineon Technologies in a written document signed by authorized representatives of Infineon Technologies, Infineon Technologies' products may not be used in any applications where a failure of the product or any consequences of the use thereof can reasonably be expected to result in personal injury.