

Perspektive
Rahmenteile:

T-WSB STV-A 25/17-1 AVU9 R8 RS
DIN LS spiegelbildlich

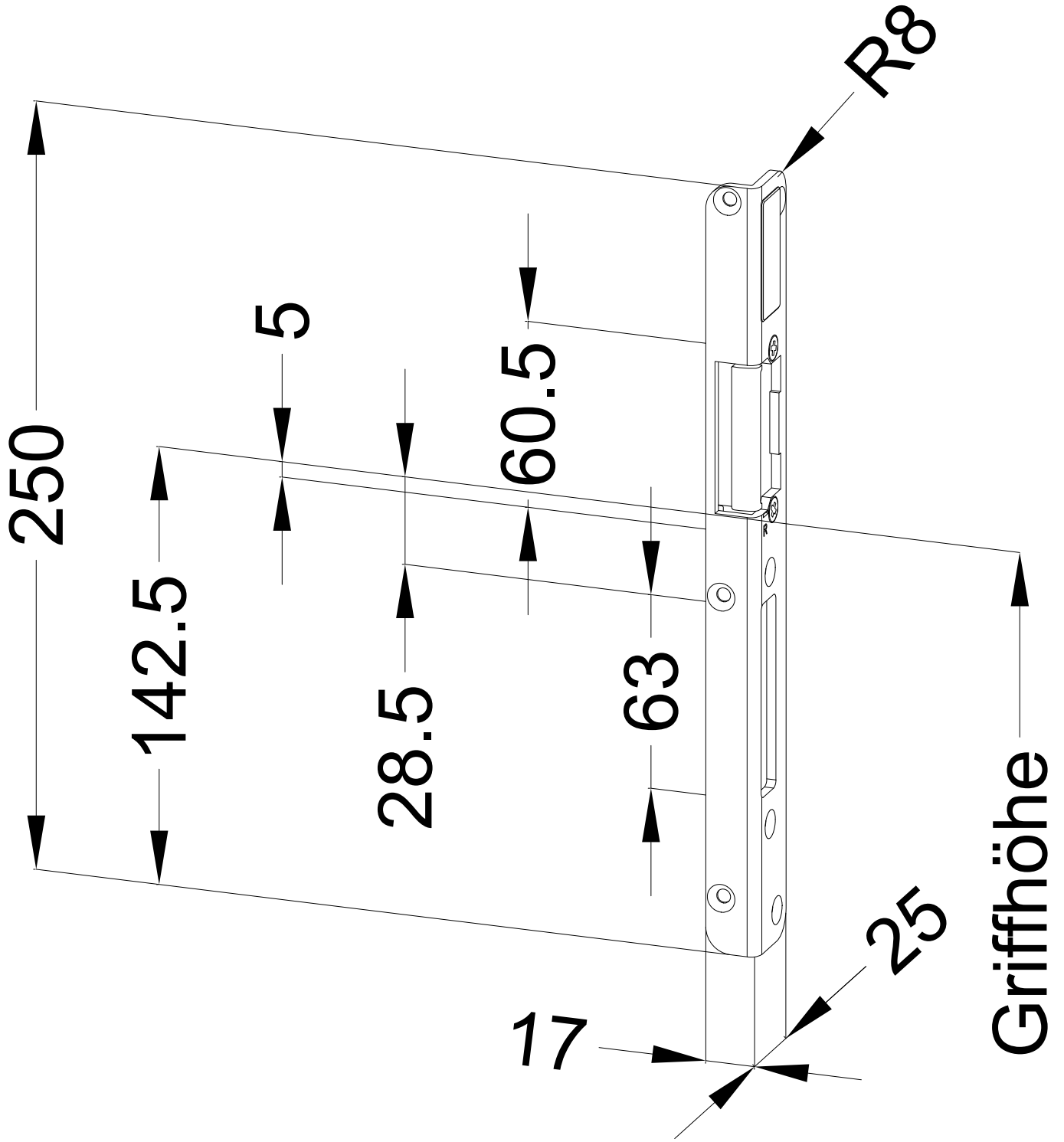

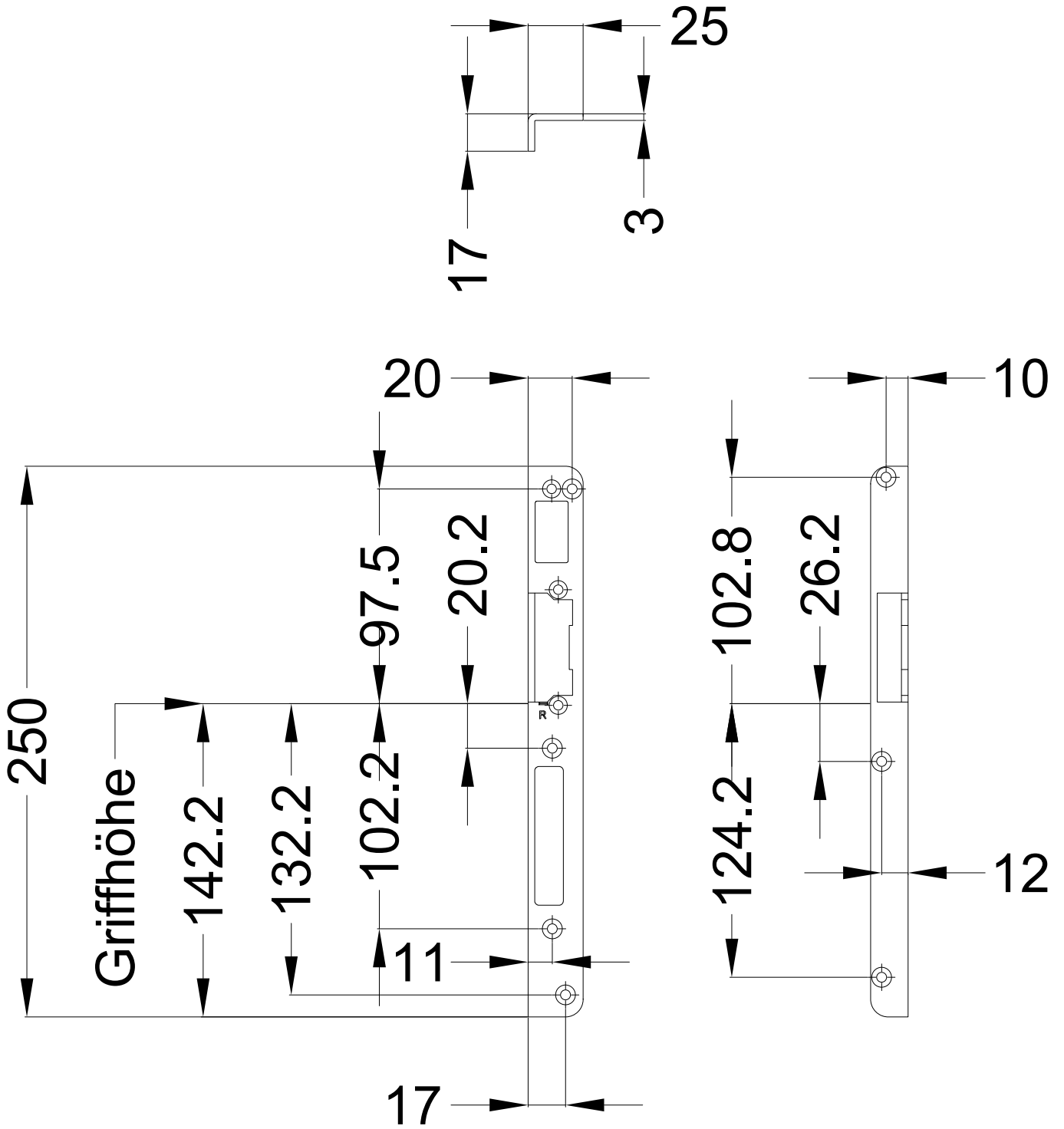

Ansichten
Rahmenteile:

T-WSB STV-A 25/17-1 AVU9 R8 RS
DIN LS spiegelbildlich

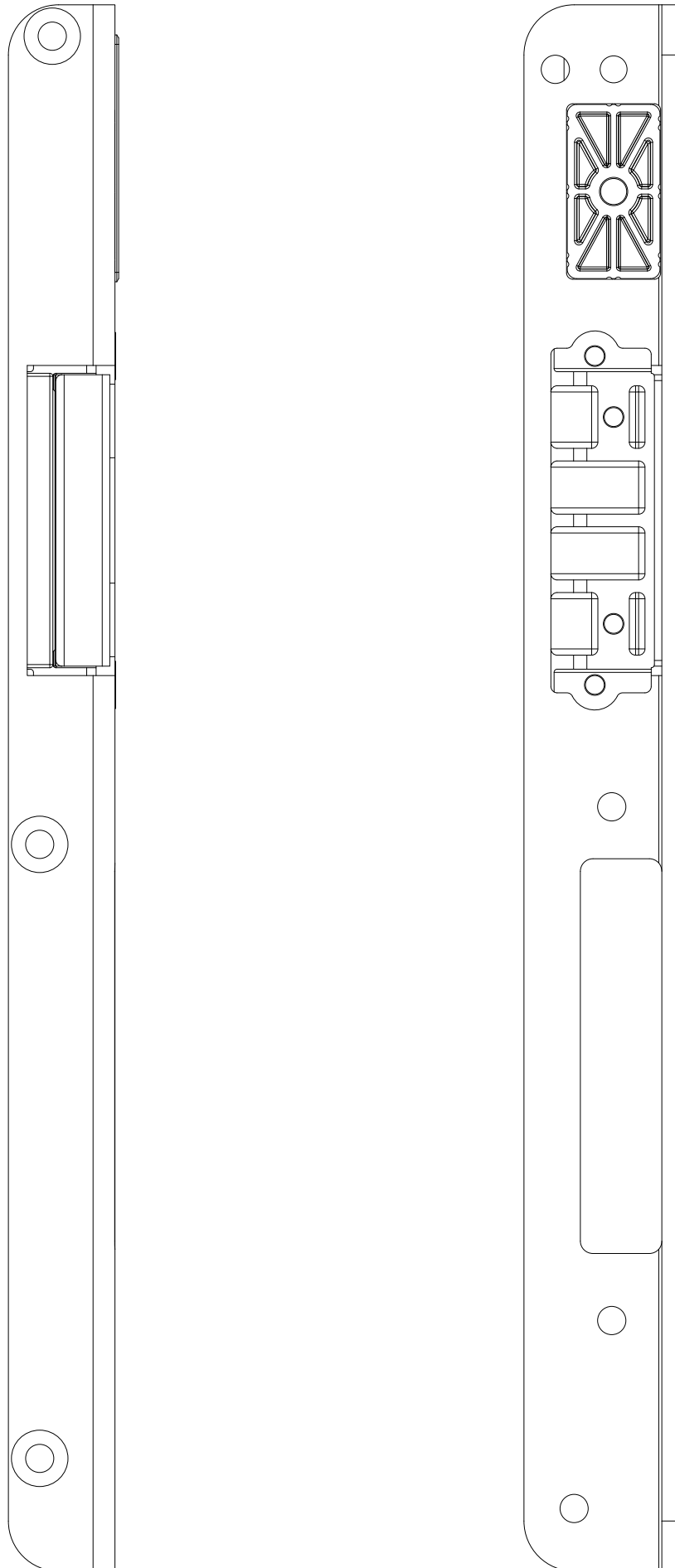

Technische Änderungen vorbehalten!

Fräsmaße

Rahmenteile:

T-WSB STV-A 25/17-1 AVU9 R8 RS
DIN LS spiegelbildlich

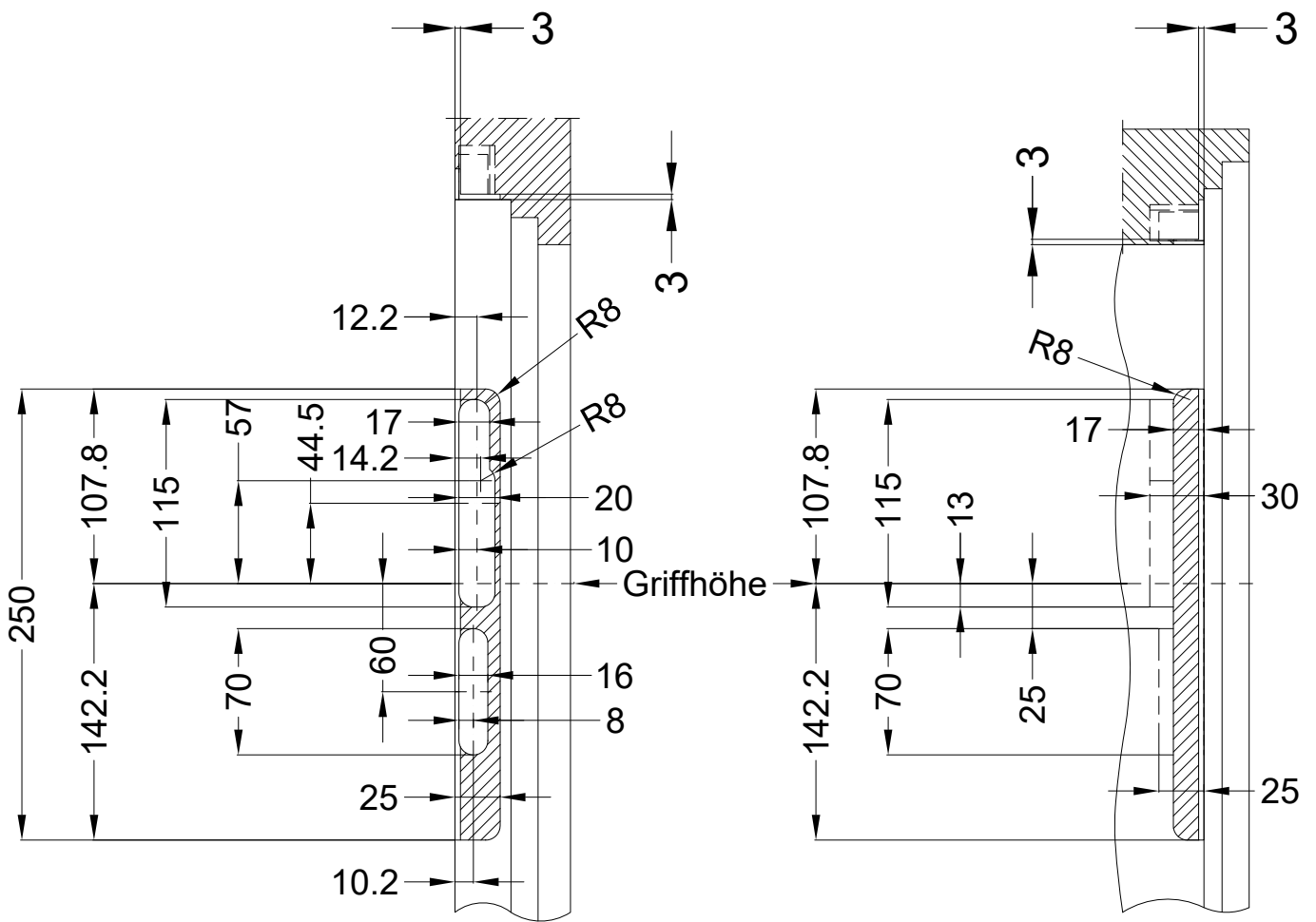

Allgemeine Vermaung

Frsmae

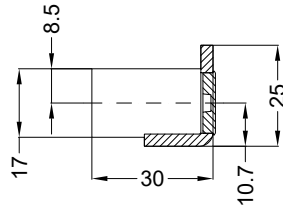
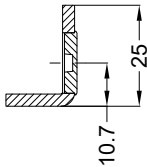

Situation
 Abdeckkappe
 MAS KS

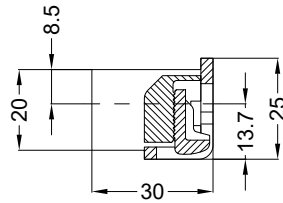
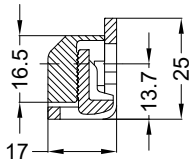

Situation
 Falle
 A-9/9 FA AV3

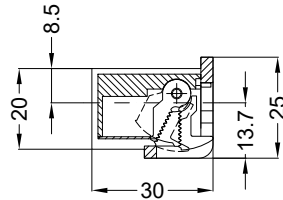
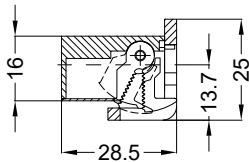

Situation
 E-ffner
 118E A71

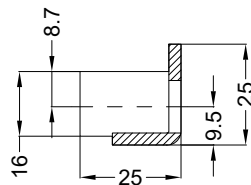
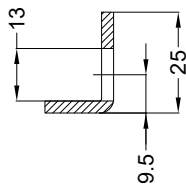

Situation
 Riegel

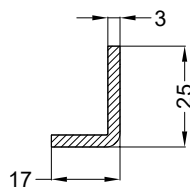
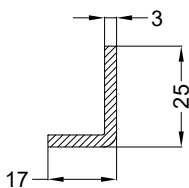

Lage
 Winkelschlieblech

Empfohlene Fräsung

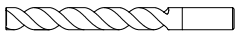

Ø 16

