

Technical Data Sheet

Full Color Top View LEDs

67-03/BHGR6W-B11/2T

Features

- P-LCC-4 package.
- White package and black surface.
- Optical indicator.
- Colorless clear window.
- Ideal for backlight and light pipe application.
- Inter reflector.
- Wide viewing angle.
- Suitable for vapor-phase reflow, Infrared reflow and wave solder processes.
- Available on tape and reel (8mm Tape).
- Pb-free.
- The product itself will remain with RoHS compliant version

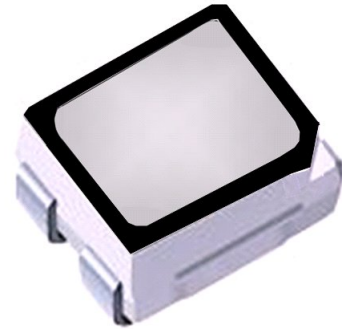

Descriptions

- The 67-03 series is available in soft orange, green, blue and yellow. Due to the package design, the LED has wide viewing angle and optimized light coupling by inter reflector. This feature makes the LED ideal for light pipe application. The low current requirement makes this device ideal for portable equipment or any other application where power is at a premium.

Applications

- Telecommunication: indicator and backlighting in telephone and fax.
- Flat backlight for LCD's, switches and symbols.
- Light pipe application.
- General use.

Device Selection Guide

Chip		Emitted Color	Resin Color
Type	Material		
R6	AlGaInP	Brilliant Red	White Diffuse
GH	InGaN	Brilliant Green	
BH	InGaN	Blue	

Technical Data Sheet

Full Color Top View LEDs

67-03/BHGHR6W-B11/2T

Package Outline Dimensions

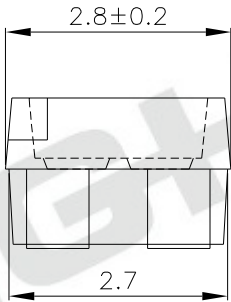
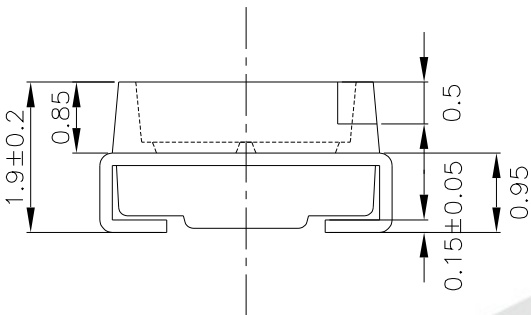
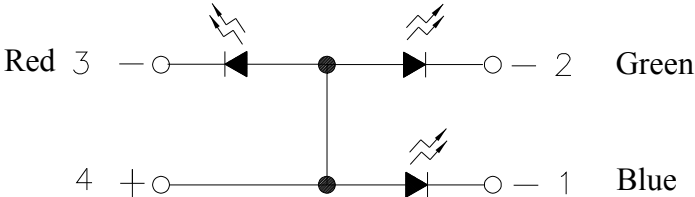
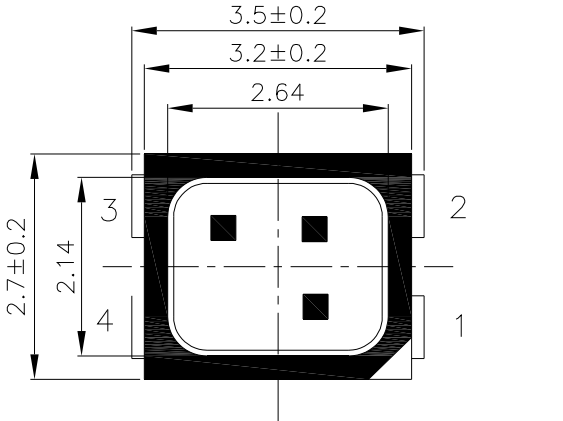

Recommended Solder Pad

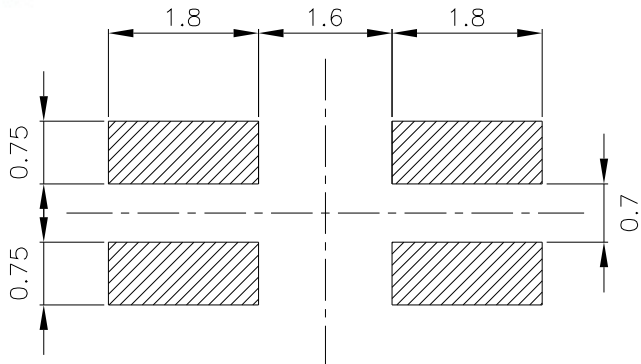
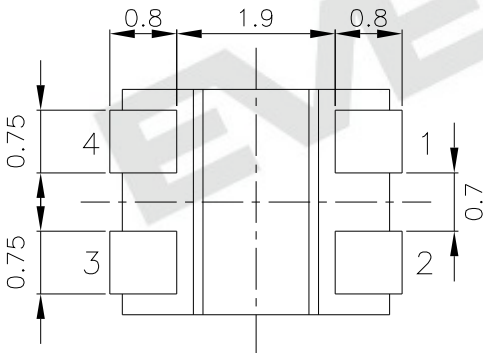

Note: The tolerances unless mentioned is $\pm 0.1\text{mm}$, Unit = mm

Technical Data Sheet

Full Color Top View LEDs

67-03/BHGHR6W-B11/2T

Absolute Maximum Ratings (Ta=25)

Parameter	Symbol	Rating		Unit
Reverse Voltage	V _R	5		V
Forward Current	I _F	R6	50	mA
		GH	25	
		BH	25	
Peak Forward Current (Duty 1/10 @ 1KHz)	I _{FP}	R6	100	mA
		GH	100	
		BH	100	
Power Dissipation	Pd	R6	120	mW
		GH	95	
		BH	95	
Electrostatic Discharge(HBM)	ESD	R6	2000	V
		GH	150	
		BH	150	
Operating Temperature	Topr	-40 ~ +85		
Storage Temperature	Tstg	-40~ +90		
Soldering Temperature	Tsol	Reflow Soldering : 260 for 10 sec. Hand Soldering : 350 for 3 sec.		

Technical Data Sheet

Full Color Top View LEDs

67-03/BHGHR6W-B11/2T

Electro-Optical Characteristics (Ta=25)

Parameter	Symbol	Min.	Typ.	Max.	Unit	Condition
Luminous Intensity	I _v	R6	180	-----	360	mcd I _F =20mA
		GH	450	-----	900	
		BH	180	-----	360	
Peak Wavelength	λ _p	R6	-----	632	-----	nm I _F =20mA
		GH	-----	518	-----	
		BH	-----	468	-----	
Dominant Wavelength	λ _d	R6	619	-----	628	nm I _F =20mA
		GH	525	-----	532.5	
		BH	465	-----	472.5	
Spectrum Radiation Bandwidth	λ	R6	-----	20	-----	nm I _F =20mA
		GH	-----	35	-----	
		BH	-----	35	-----	
Forward Voltage	V _F	R6	1.75	-----	2.35	V I _F =20mA
		GH	2.9	-----	3.5	
		BH	2.9	-----	3.5	
Viewing Angle	201/2	-----	120	-----	deg	I _F =20mA
Reverse Current	I _R	R6	-----	-----	10	μA V _R =5V
		GH	-----	-----	50	
		BH	-----	-----	50	

Note:

1. Tolerance of Luminous Intensity: ±11%
2. Tolerance of Dominant Wavelength: ±1nm
3. Tolerance of Forward Voltage: ±0.1V

Technical Data Sheet

Full Color Top View LEDs

67-03/BHGHR6W-B11/2T

Bin Range of Luminous Intensity

Symbol		Bin Code	Min.	Max.	Unit	Condition
Iv	R6	S1	180	225	mcd	I _F =20mA
		S2	225	285		
		T1	285	360		
	GH	U1	450	565		
		U2	565	715		
		V1	715	900		
	BH	S1	180	225		
		S2	225	285		
		T1	285	360		

Bin Range of Dominant Wavelength

Symbol		Bin Code	Min.	Max.	Unit	Condition
λ _d	R6	R1	619	622	nm	I _F =20mA
		R2	622	625		
		R3	625	628		
	GH	G1	525	527.5		
		G2	527.5	530		
		G3	530	532.5		
	BH	B1	465	467.5		
		B2	467.5	470		
		B3	470	472.5		

Note:

1. Tolerance of Luminous Intensity: ±11%
2. Tolerance of Dominant Wavelength: ±1nm

Technical Data Sheet

Full Color Top View LEDs

67-03/BHGHR6W-B11/2T

Bin Range of Forward Voltage

Symbol		Bin Code	Min.	Max.	Unit	Condition
V _F	R6	0	1.75	1.95	V	I _F = 20mA
		1	1.95	2.15		
		2	2.15	2.35		
	GH	11	2.90	3.10		
		12	3.10	3.30		
		13	3.30	3.50		
	BH	11	2.90	3.10		
		12	3.10	3.30		
		13	3.30	3.50		

Note:

1. Tolerance of Forward Voltage: $\pm 0.1V$

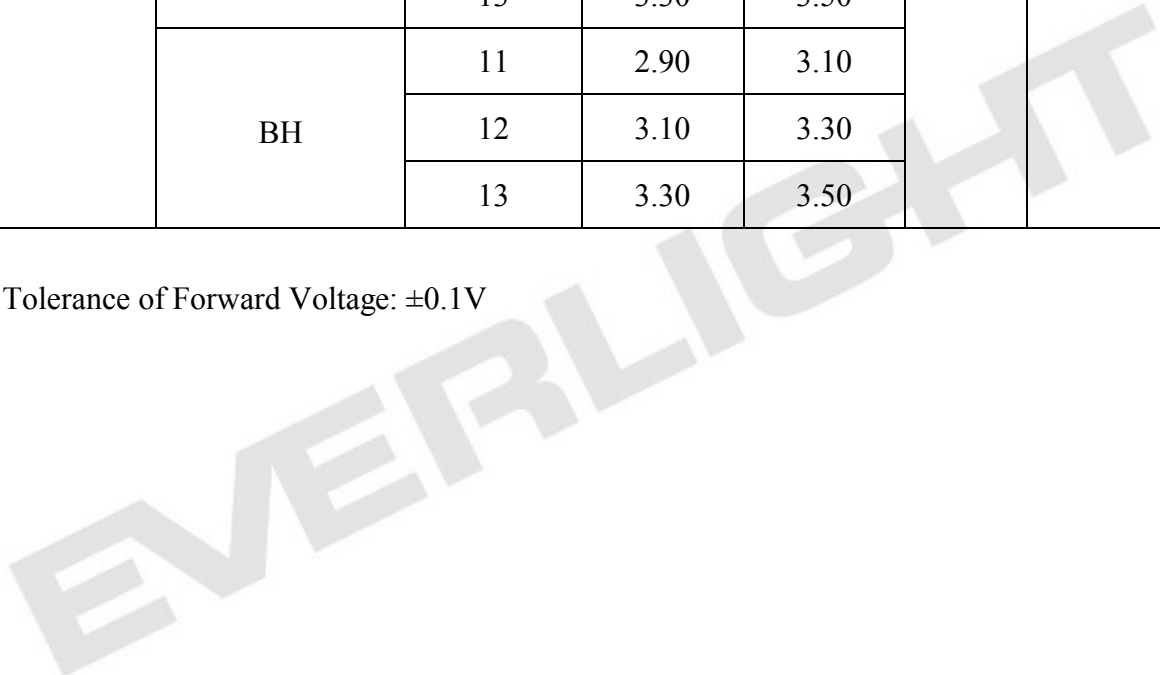

Technical Data Sheet

Full Color Top View LEDs

67-03/BHGHR6W-B11/2T

Typical Electro-Optical Characteristics Curves (BH)

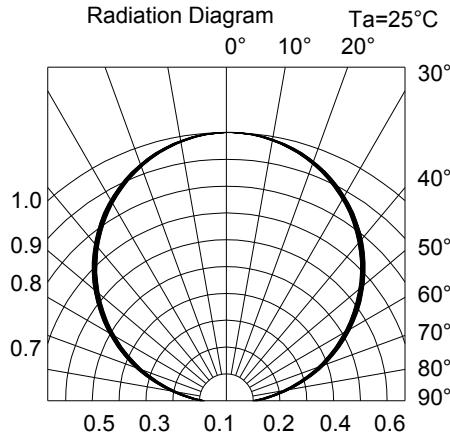
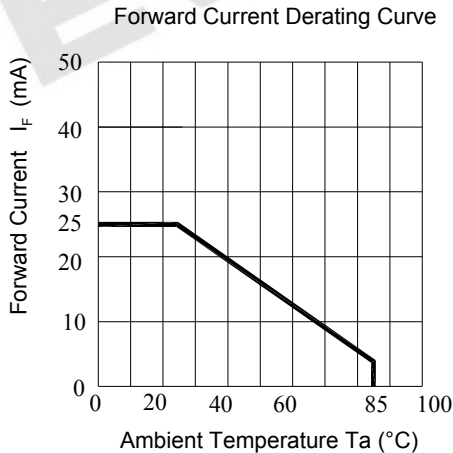
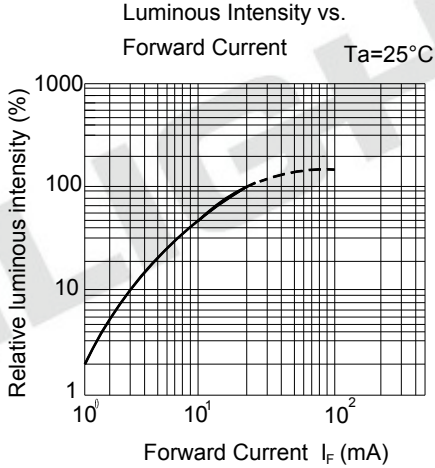
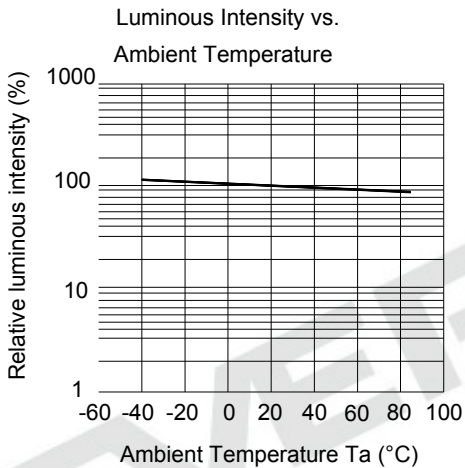
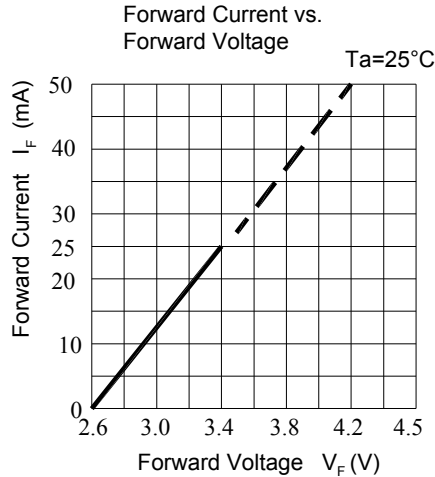
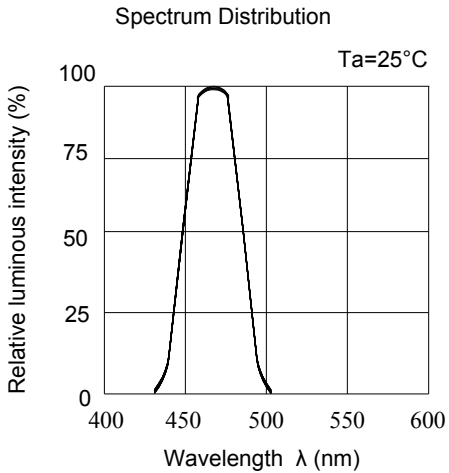

Technical Data Sheet

Full Color Top View LEDs

67-03/BHGR6W-B11/2T

Typical Electro-Optical Characteristics Curves (GH)

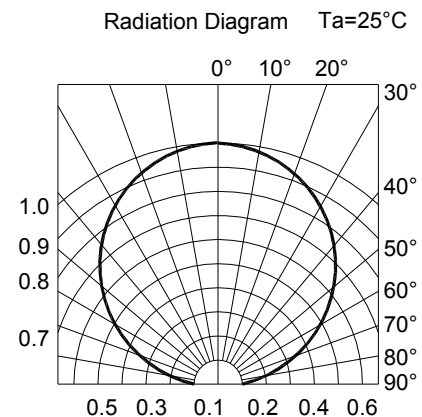
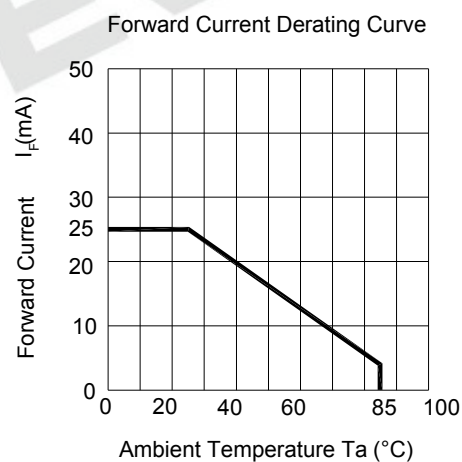
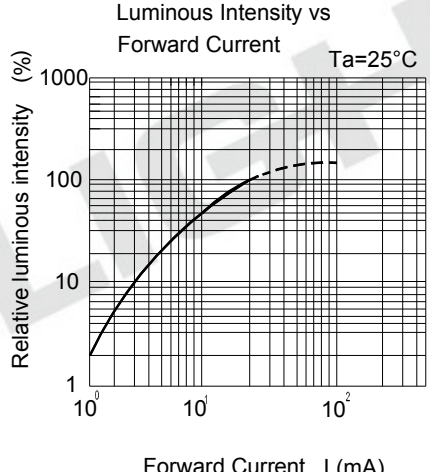
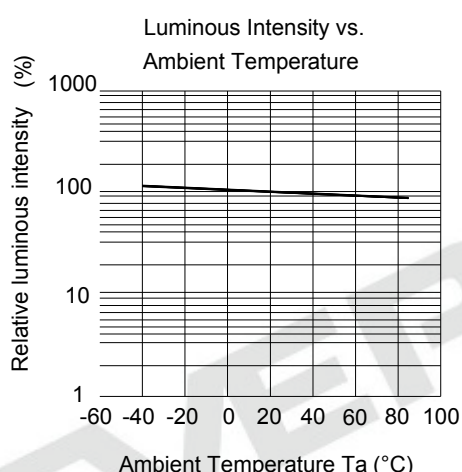
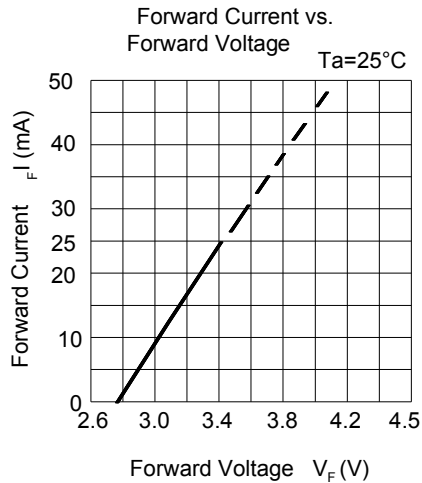
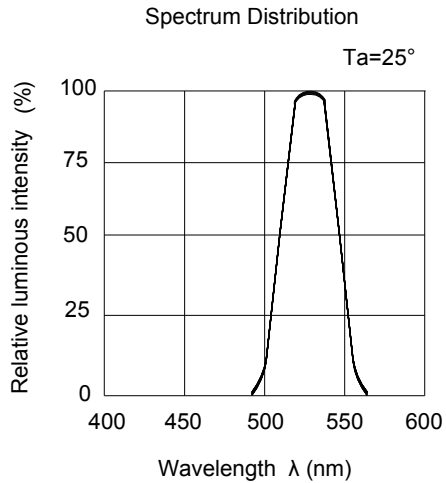

Technical Data Sheet

Full Color Top View LEDs

67-03/BHGR6W-B11/2T

Typical Electro-Optical Characteristics Curves (R6)

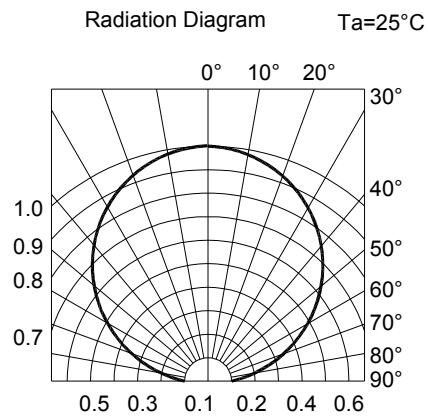
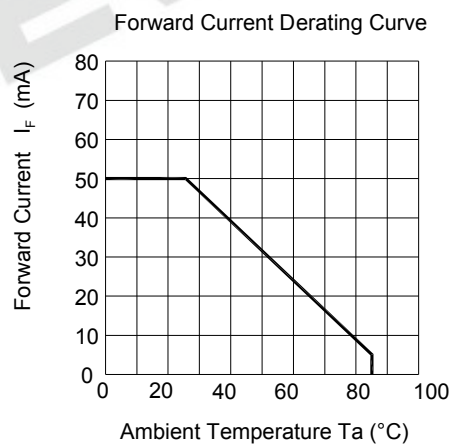
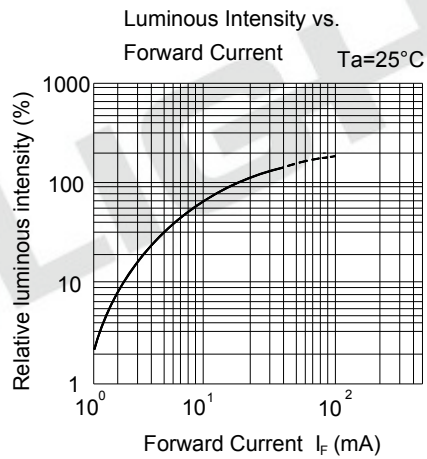
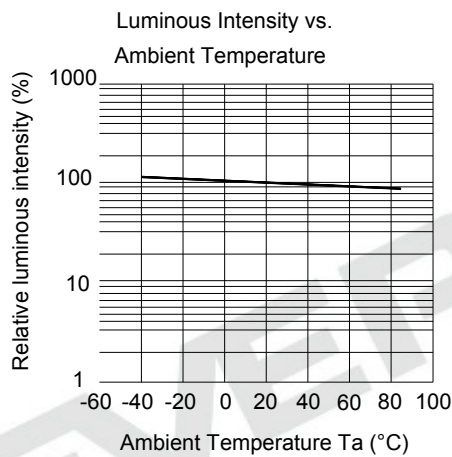
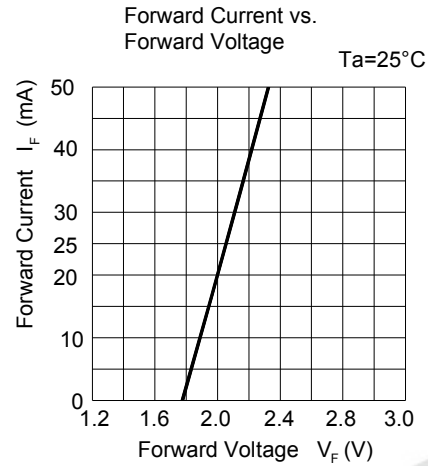
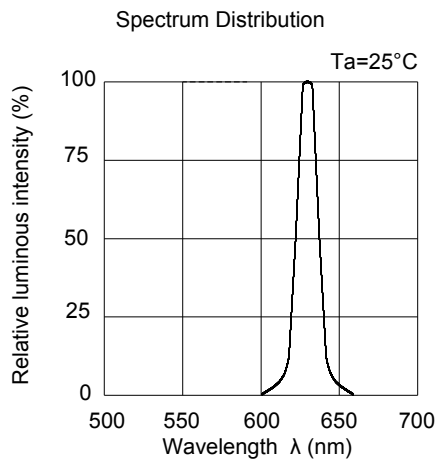

Technical Data Sheet Full Color Top View LEDs

67-03/BHGHR6W-B11/2T

Label Explanation

- CAT: Luminous Intensity Rank
- HUE: Dom. Wavelength Rank
- REF: Forward Voltage Rank



Reel Dimensions

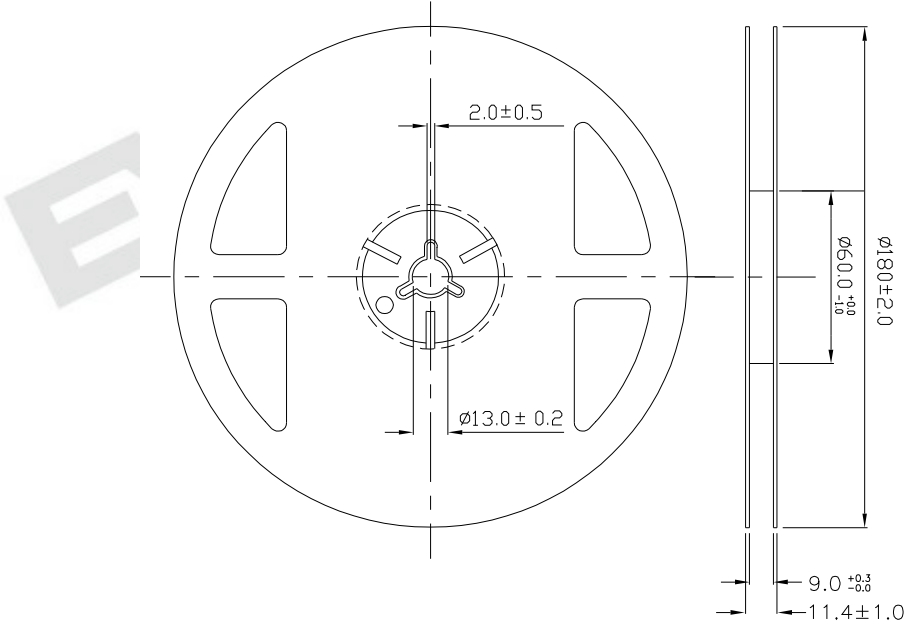

Note: Tolerance unless mentioned is ±0.1mm; Unit = mm

Technical Data Sheet

Full Color Top View LEDs

67-03/BHGHR6W-B11/2T

Carrier Tape Dimensions: Loaded Quantity 2000 pcs Per Reel.

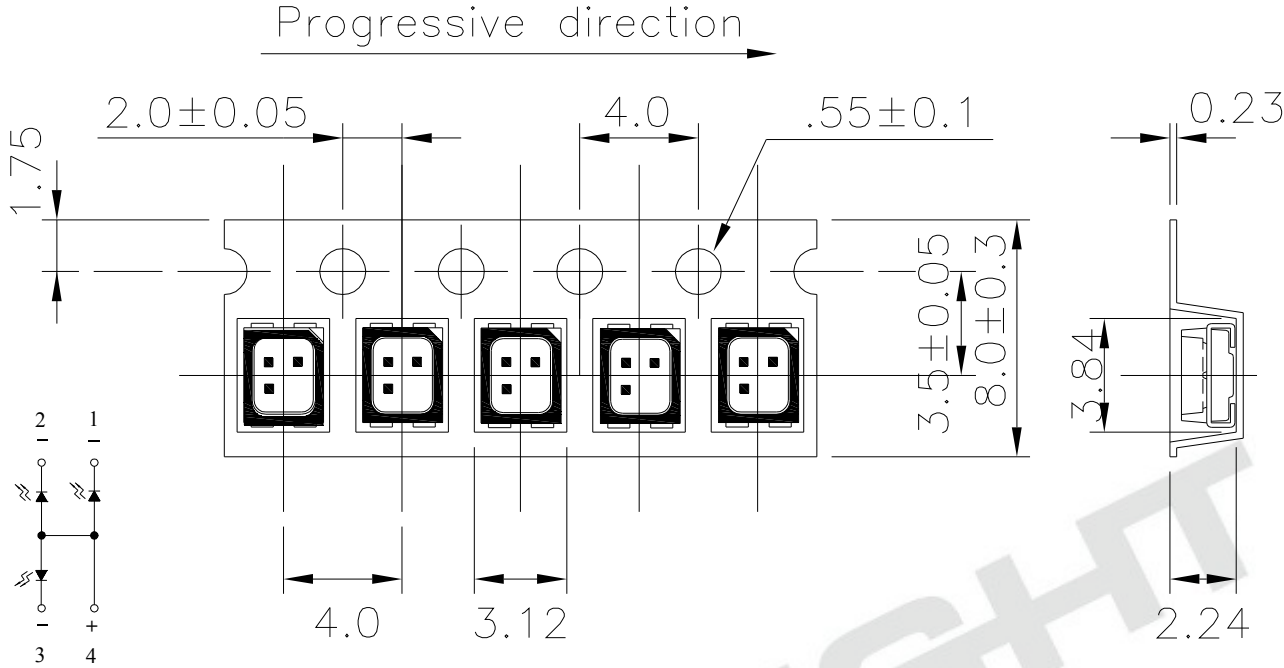

Note: Tolerance unless mentioned is ± 0.1 mm; Unit = mm

Moisture Resistant Packaging

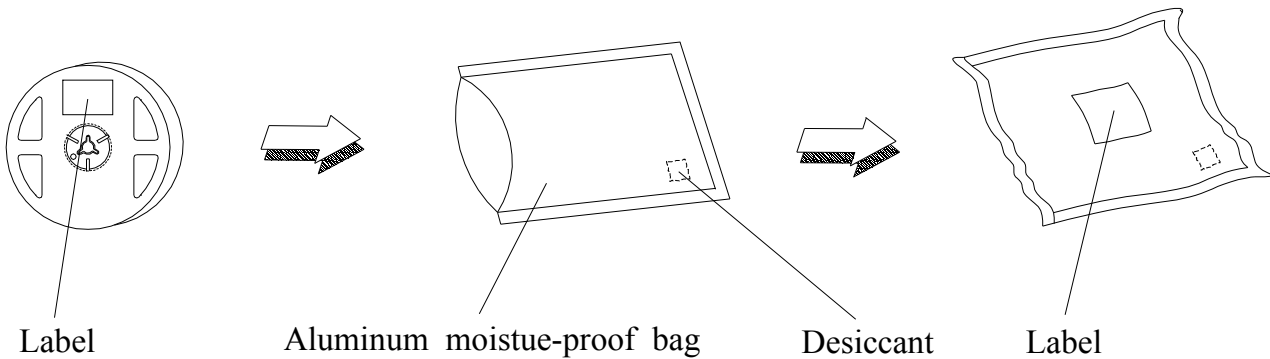

Technical Data Sheet

Full Color Top View LEDs

67-03/BHGHR6W-B11/2T

Reliability Test Items and Conditions

The reliability of products shall be satisfied with items listed below.

Confidence level : 90%

LTPD : 10%

No.	Items	Test Condition	Test Hours/Cycles	Sample Size	Ac/Re
1	Reflow Soldering	Temp. : 260 ±5 Min. 5sec.	6 Min.	22 PCS.	0/1
2	Temperature Cycle	H : +100 15min ∫ 5 min L : -40 15min	300 Cycles	22 PCS.	0/1
3	Thermal Shock	H : +100 5min ∫ 10 sec L : -10 5min	300 Cycles	22 PCS.	0/1
4	High Temperature Storage	Temp. : 100	1000 Hrs.	22 PCS.	0/1
5	Low Temperature Storage	Temp. : -40	1000 Hrs.	22 PCS.	0/1
6	DC Operating Life	I _F = 20 mA	1000 Hrs.	22 PCS.	0/1
7	High Temperature / High Humidity	85 / 85%RH	1000 Hrs.	22 PCS.	0/1

Technical Data Sheet

Full Color Top View LEDs

67-03/BHGHR6W-B11/2T

Precautions for Use

1. Over-current-proof

Customer must apply resistors for protection; otherwise slight voltage shift will cause big current change (Burn out will happen).

2. Storage

2.1 Do not open moisture proof bag before the products are ready to use.

2.2 Before opening the package: The LEDs should be kept at 30 °C or less and 90%RH or less.

2.3 After opening the package: The LED's floor life is 168 hr under 30 °C or less and 60% RH or less. If unused LEDs remain, it should be stored in moisture proof packages.

2.4 If the moisture absorbent material (silica gel) has faded away or the LEDs have exceeded the storage time, baking treatment should be performed using the following conditions.

Baking treatment: 60±5 °C for 24 hours.

3. Soldering Condition

3.1 Pb-free solder temperature profile

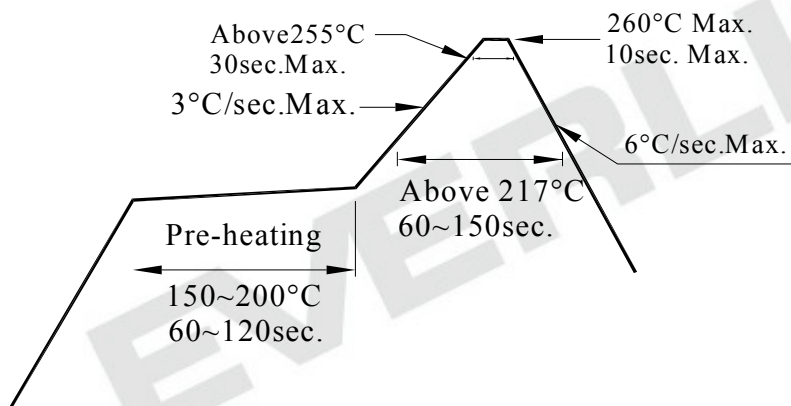

3.2 Reflow soldering should not be done more than two times.

3.3 When soldering, do not put stress on the LEDs during heating.

3.4 After soldering, do not warp the circuit board.

Technical Data Sheet

Full Color Top View LEDs

67-03/BHGR6W-B11/2T

4. Soldering Iron

Each terminal is to go to the tip of soldering iron temperature less than 350 for 3 seconds within once in less than the soldering iron capacity 25W. Leave two seconds and more intervals, and do soldering of each terminal. Be careful because the damage of the product is often started at the time of the hand solder.

5. Repairing

Repair should not be done after the LEDs have been soldered. When repairing is unavoidable, a double-head soldering iron should be used (as below figure). It should be confirmed beforehand whether the characteristics of the LEDs will or will not be damaged by repairing.

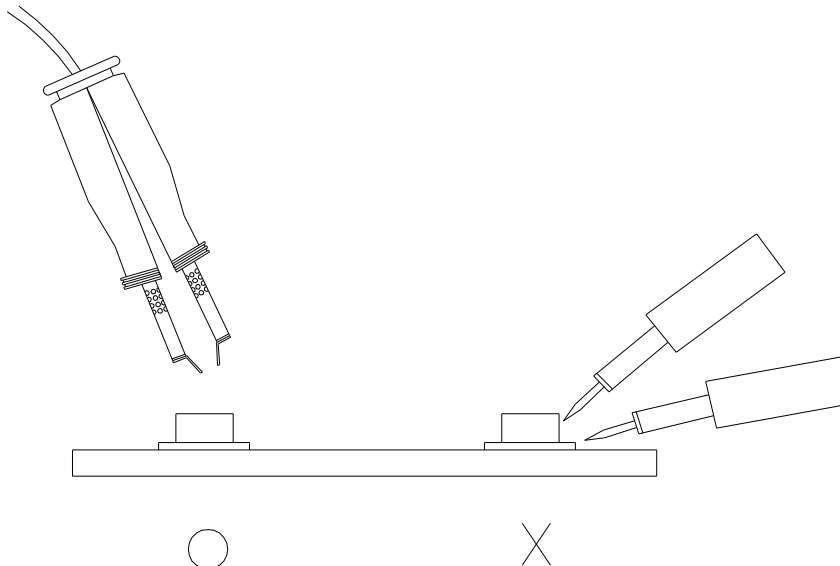

EVERLIGHT ELECTRONICS CO., LTD.
Office: No 25, Lane 76, Sec 3, Chung Yang Rd,
Tucheng, Taipei 236, Taiwan, R.O.C

Tel: 886-2-2267-2000, 2267-9936
Fax: 886-2267-6244, 2267-6189, 2267-6306
<http://www.everlight.com>