

PLCC (Clamshell)

IC51 Series

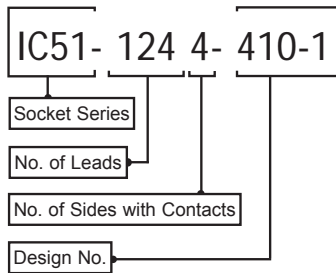

Characteristics

Insulation Resistance: 1,000M Ω minimum at 500 VDC
 Withstanding Voltage: 700 VAC for 1 minute
 Contact Resistance: 30m Ω max. at 10mA/20mV (Initial)
 Operating Temperature: -55°C ~ +170°C

Material

Insulator: PEI (Glass Filled)
 Contact: Beryllium Copper
 Plating: Gold over Nickel

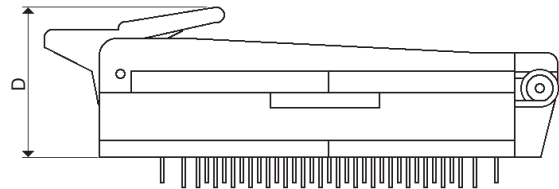
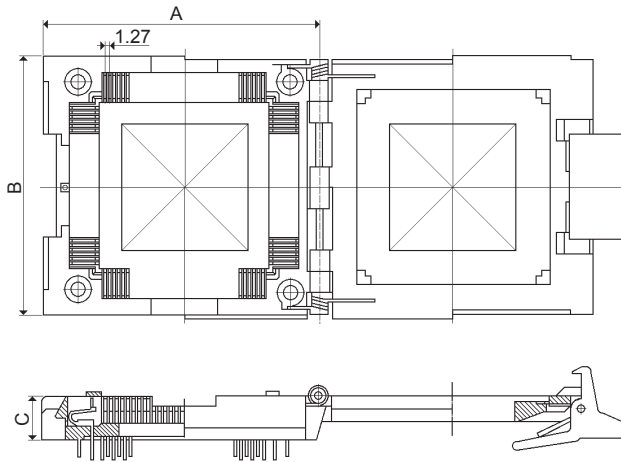

Part Number	No. of Leads	A	B	C (Open)	D (Closed)
IC51-0184-398	18	52	30.0	9.0	2.0
IC51-0204-415	20	54.0	26.0	10.0	20.5
IC51-0204-602	20	31.5	26.0	10.0	20.0
IC51-0224-570	22	29.5	30.0	9.0	19.5
IC51-0284-399	28	36.0	30.0	10.0	20.5
IC51-0324-453	32	35.0	30.0	9.0	19.5
IC51-0444-400	44	40.0	34.0	10.0	20.0
IC51-0524-411-1	52	43.0	38.0	10.0	23.5
IC51-0684-390-1	68	49.0	42.0	10.0	23.5
IC51-0844-401-1	84	55.0	48.0	10.0	23.5
IC51-1004-405-1	100	60.0	54.0	10.0	23.5
IC51-1244-410-1	124	65.0	60.0	10.0	23.5

PC BOARD LAYOUTS

PLCC (Clamshell)

IC51 Series

IC51-0204-602 (20 Pins)

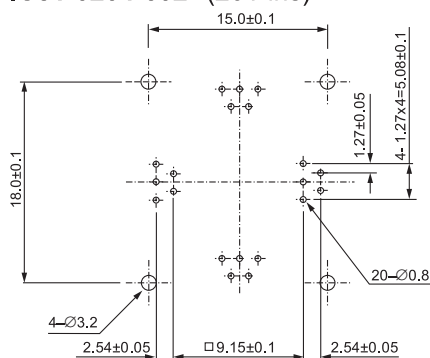

IC51-0444-400 (44 Pins)

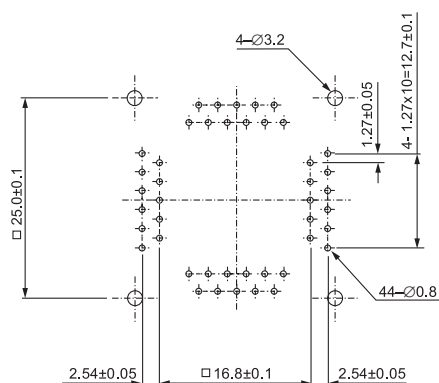

IC51-0284-399 (28 Pins)

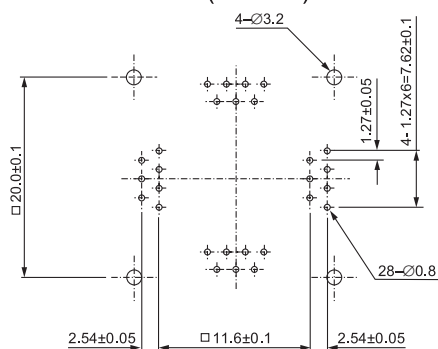

IC51-0524-411-1 (52 Pins)

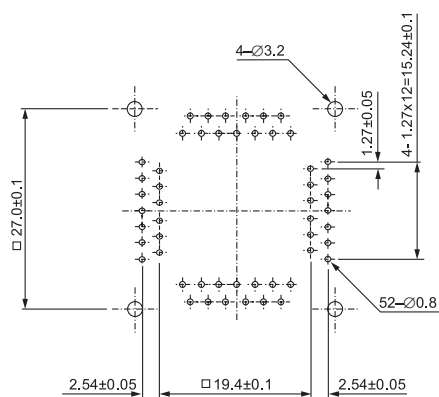

IC51-0324-453 (32 Pins)

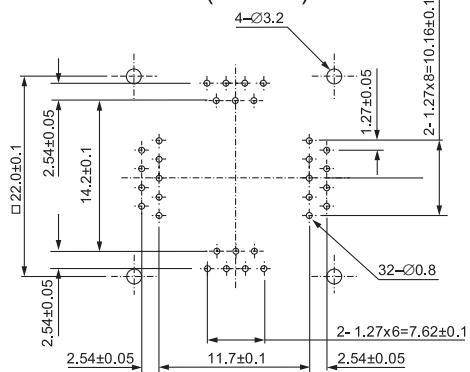

Quad Flat Packages

IC51 Series

IC51-0684-390-1 (68 Pins)

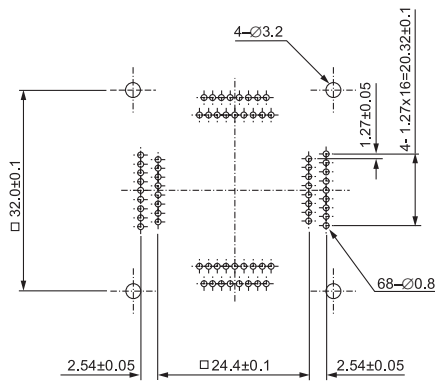

IC51-1004-405-1 (100 Pins)

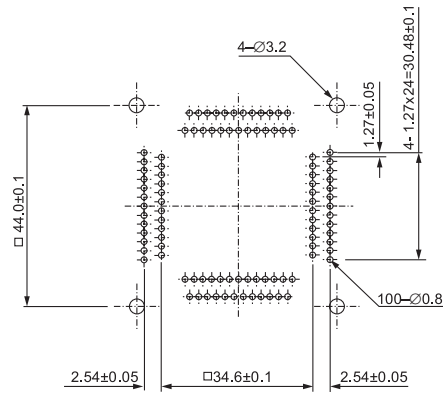

IC51-0844-401-1 (84 Pins)

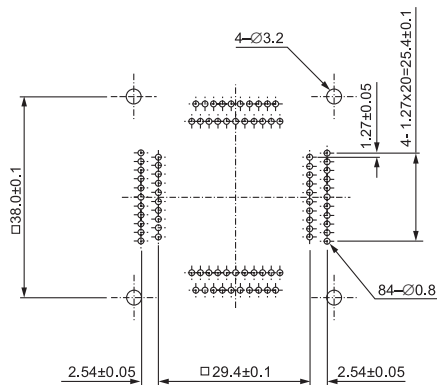

IC51-1244-410-1 (124 Pins)

