

# UTS Series 1823

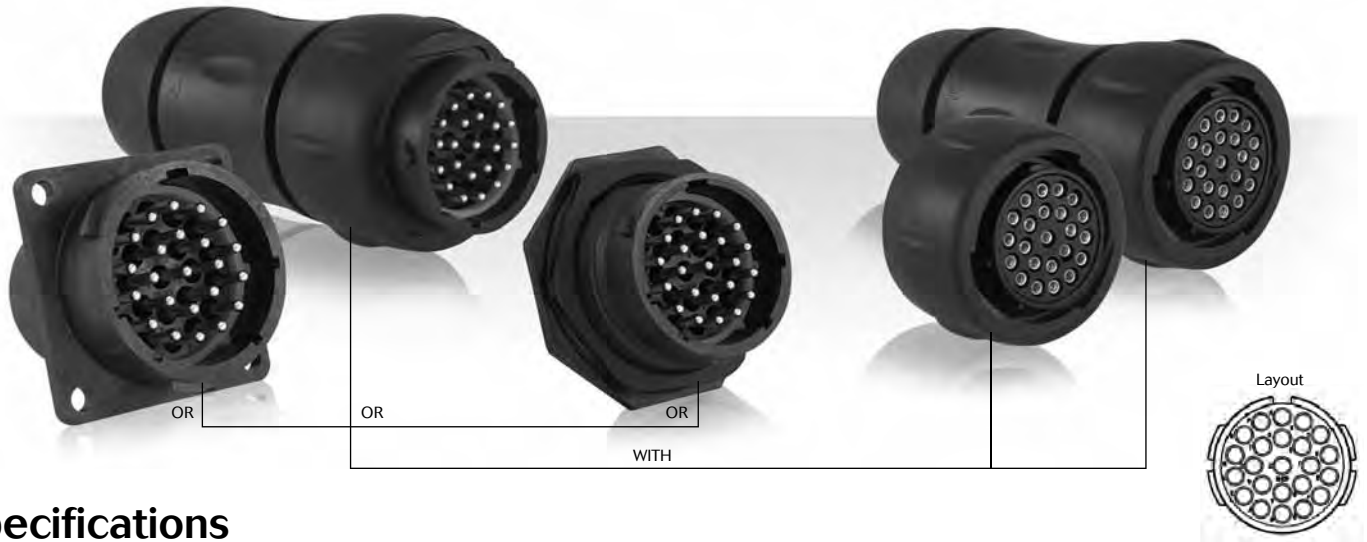

## Specifications

Contact type	Connector type	Backshell	Part number	
			Male insert	Female insert
Crimp contacts supply separately see page 135	Square flange receptacle	Without (Fig.1)	UTS01823P	UTS01823S
	Free hanging receptacle	Cable gland (Fig.2)	UTS1JC1823P	UTS1JC1823S
	Plug	Without (Fig.3)	UTS61823P	UTS61823S
	Plug	Cable gland (Fig.4)	UTS6JC1823P	UTS6JC1823S
	Jam nut receptacle	Without (Fig.5)	UTS71823P	UTS71823S
PCB contacts supply separately see page 135	Square flange receptacle	Without (Fig.1)	UTS01823P	UTS01823S
	Jam nut receptacle	Without (Fig.5)	UTS71823P	UTS71823S



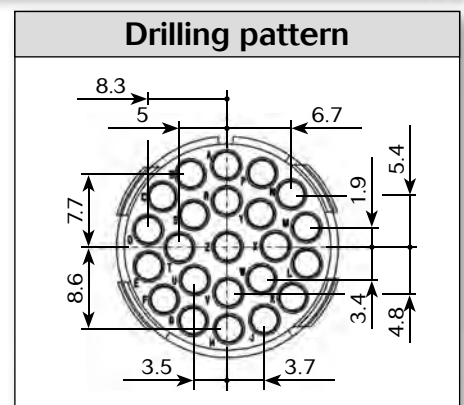
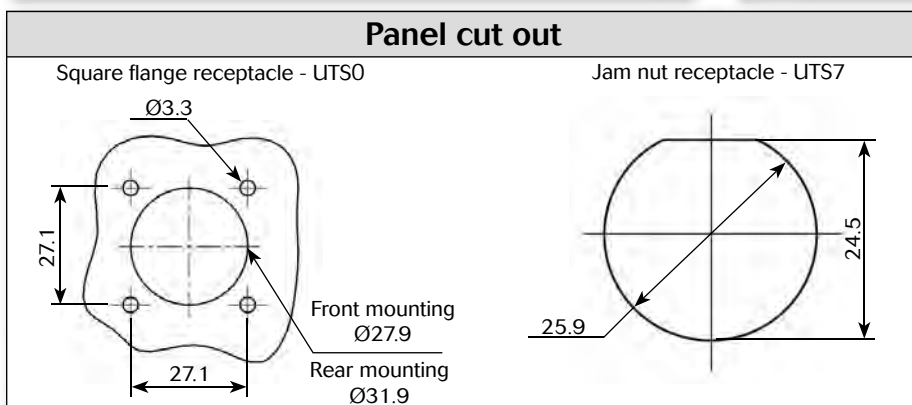
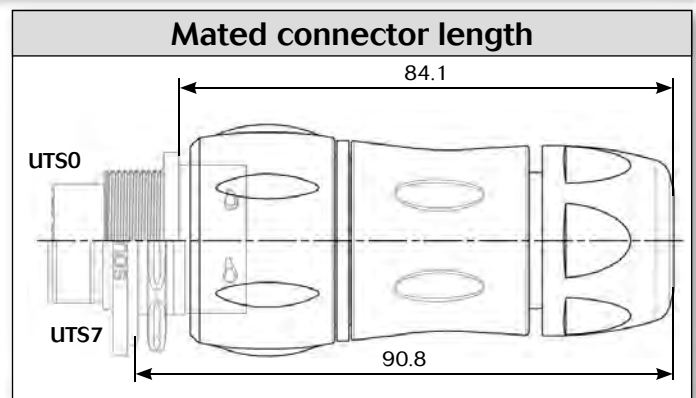
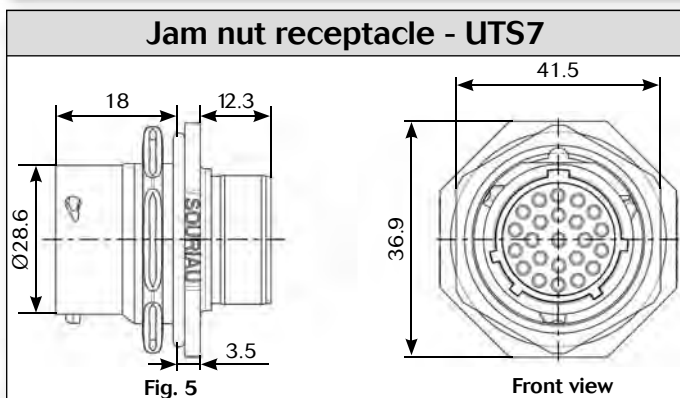
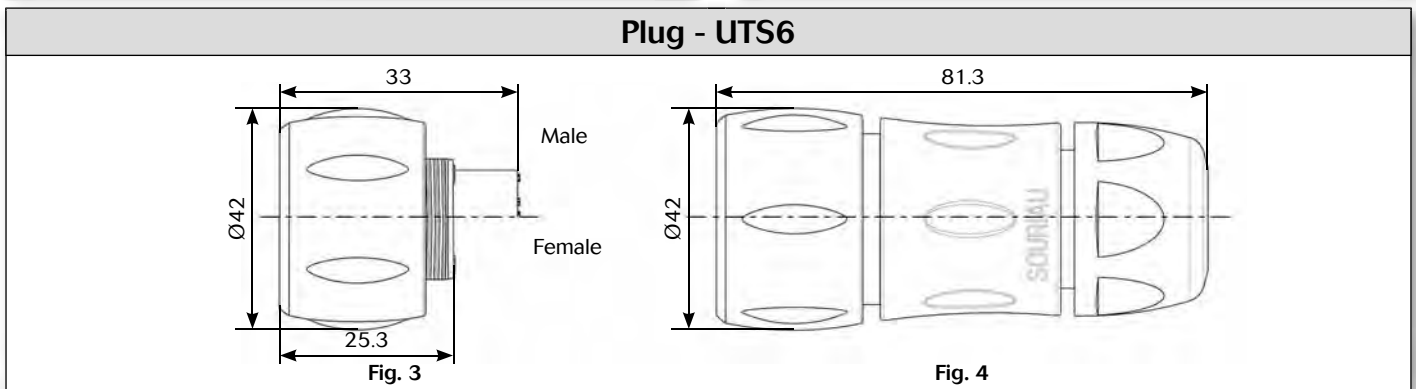
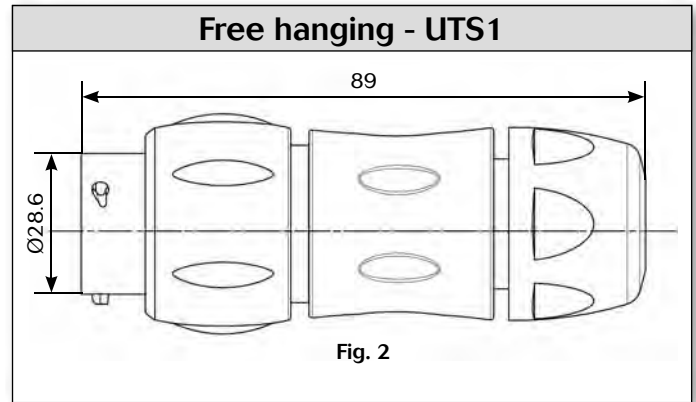
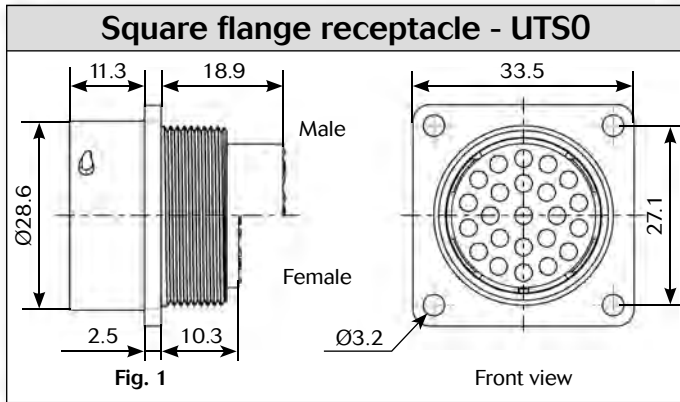

### Dimensions



Note: all dimensions are in mm



### Accessories and tooling

Jam nut sealing caps	
	
Part number	Part number
UTS18DCG	UTS18DCGR

Metal terminal

Handle

Part number
SHANGLES

Tool kit

Part number
TOOLKIT

Plug sealing cap

Part number
UTS618DCG

Square flange sealing cap

Part number
UTS18DCGE

Metal terminal

Plastic protective cap	
	
Part numbers	
Receptacle cap	Plug cap
8500-5590A	8500-5599

Gasket

Part numbers / neoprene
UTFD16B

Crimp tooling			
			
Contacts	Contact size	Part number of head	
RM/RC 28M1K <sup>(1)</sup>	Standard contacts #16 Ø 1.6mm	S16RCM20	
RM/RC 24M9K <sup>(1)</sup>		S16RCM20	
RM/RC 20M13K <sup>(1)</sup>		S16RCM20	
RM/RC 20M12K <sup>(1)</sup>		S16RCM20	
RM/RC 16M23K <sup>(1)</sup>		S16RCM16	
RM/RC 14M50K <sup>(1)</sup>		S16RCM1450	
RM/RC 14M30K <sup>(1)</sup>		S16RCM14	
SM/SC 24ML1TK6 <sup>(1)</sup>		S16SCM20	
SM/SC 20ML1TK6 <sup>(1)</sup>		S16SCM20	
SM/SC 16ML1TK6 <sup>(1)</sup>		S16SCML1	
SM/SC 14ML1TK6 <sup>(1)</sup>		S16SCML1	
SM/SC 16ML1TK6 <sup>(1)</sup>		S16SCML11	
RMDXK10D28K		Coaxial contacts	M10S-1J
RCDXK1D28K			M10S-1J
RM/RC DX60xxD28K	M10S-1J		
RM/RC DXK10D28 + york090	M10S-1J		
RM/RC DX60xxD28	M10S-1J		

(1): example of plating, for other plating see UTS catalog page 143



### Contacts

#16	Contact type	AWG	Part number		Max wire Ø	Max insulator Ø
			Male	Female		
Crimp	Machined	30-28	RM28M1K <sup>(1)</sup>	RC28M1K <sup>(1)</sup>	0.55	1.1
		26-24	RM24M9K <sup>(1)</sup>	RC24M9K <sup>(1)</sup>	0.8	1.6
		22-20	RM20M13K <sup>(1)</sup>	RC20M13K <sup>(1)</sup>	1.18	1.8
		22-20	RM20M12K <sup>(1)</sup>	RC20M12K <sup>(1)</sup>	1.18	2.2
		20-16	RM16M23K <sup>(1)</sup>	RC16M23K <sup>(1)</sup>	1.8	3.2
		16-14	RM14M50K <sup>(1)</sup>	RC14M50K <sup>(1)</sup>	2.05	3.2
		16-14	RM14M30K <sup>(1)</sup>	RC14M30K <sup>(1)</sup>	2.28	3.2
	Stamped & formed reeled contacts	26-24	SM24M1TK6 <sup>(1)(2)</sup>	SC24M1TK6 <sup>(1)(2)</sup>	0.89-1.28	-
		22-20	SM20M1TK6 <sup>(1)(2)</sup>	SC20M1TK6 <sup>(1)(2)</sup>	1.17-2.08	-
		18-16	SM16M1TK6 <sup>(1)(2)</sup>	SC16M1TK6 <sup>(1)(2)</sup>	3.0	-
18-16		SM16M11TK6 <sup>(1)(2)</sup>	SC16M11TK6 <sup>(1)(2)</sup>	2.0-3.0	-	
14		SM14M1TK6 <sup>(1)(2)</sup>	SC14M1TK6 <sup>(1)(2)</sup>	3.2	-	
PCB	Machined <sup>(3)</sup>	-	RM20M12E8K <sup>(1)</sup>	RC20M12E84K <sup>(1)</sup>	-	-
Coaxial	Cable Multipiece	-	RMDXK10D28	RCDXK1D28	-	-
	Cable Monocrimp	-	RMDX60xxD28	RCDX60xxD28	-	-
	Twisted pair Multipiece	-	RMDXK10D28 + york090	RCDXK1D28 + york090	-	-
	Twisted pair Monocrimp	-	RMDX60xxD28	RCDX60xxD28	-	-
Fiber optic	POF contacts Plastic optical fibre	-	RMPOF1000	RCPOF1000B	-	-

(1): Example of plating, for other plating see page 143  
 (2): Loose piece contact available if putting L. Example: SM20ML1-TK6  
 (3): For dimensions see page 148

Electrical characteristics
<p><b>UL</b> 10A 500V UL94 V-0</p> <p><b>CSA</b> 7A 500V UL94 V-0</p> <p><b>IEC</b> 9A 63V 1.5kV 3</p>

