

## M12 FEMALE 90° SHIELDED

PVC 4X0.34 shielded black UL,CSA 15m

M12  
Female 90°  
4-pole, shielded

Plastic housings with good resistance against chemicals and oils. The resistance to aggressive media should be individually tested for your application. Further details on request. Further cable lengths on request.

### [Link to Product](#)

#### Illustration

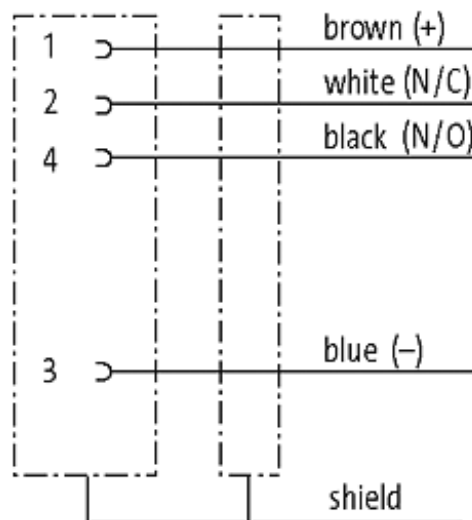

# Female

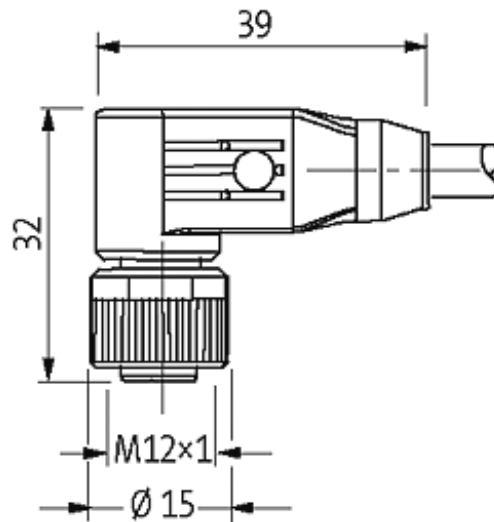

Product may differ from Image