

**STRAIGHT BULKHEAD JACK FULL CRIMP-TYPE
CABLE 2.6/50 D**

R124.313.120
SERIES SMA-COM

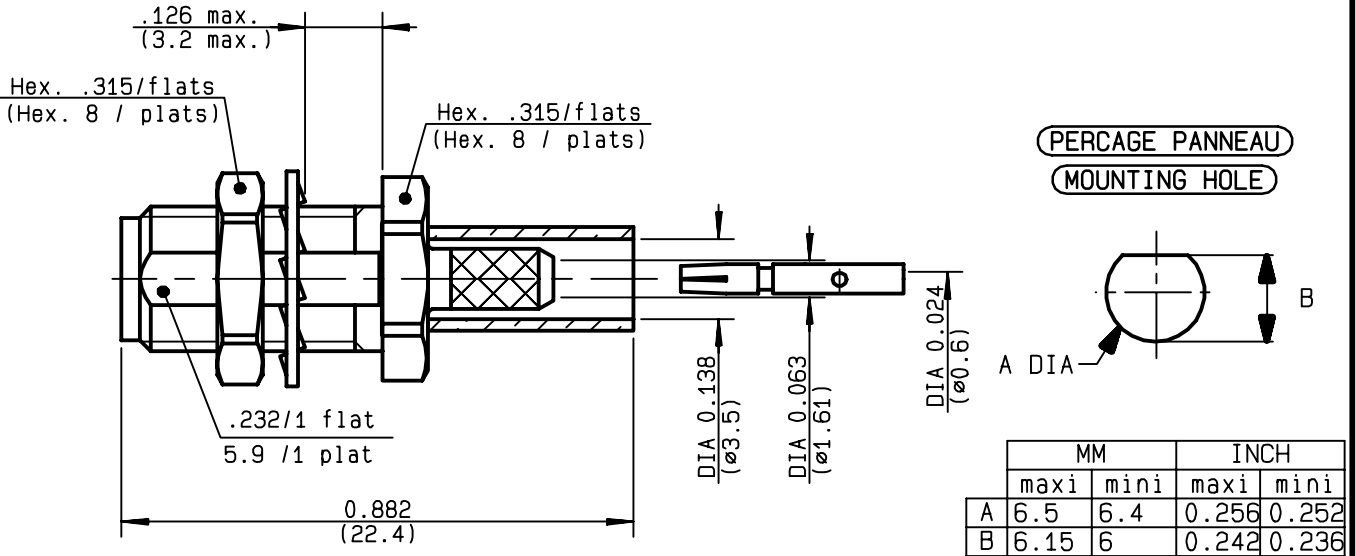

NOMINAL IMPEDANCE	50 Ω
FREQUENCY RANGE	0-12.4 GHz
TEMPERATURE RATING	-65/+165 °C
V.S.W.R	1.15 + .02 x F(GHz)Maxi
RF INSERTION LOSS	0.05 √F(GHz) dB Maxi
VOLTAGE RATING	250 Veff Maxi
DIELECTRIC WITHSTANDING VOLTAGE	750 Veff Mini
INSULATION RESISTANCE	5000 MΩMini
HERMETIC SEAL	NA Atm.cm ³ /s
LEAKAGE (pressurized only)	NA
MECHANICAL DURABILITY	100 Cycles
WEIGHT	3.5 gr
SPECIFICATION	

CABLES : **K02252D**
RD 316

OTHERS CHARACTERISTICS

CABLE RETENTION	110 N Mini
CENTER CONTACT RETENTION	
Axial force - mating end	18 N Mini
Axial force - opposite end	18 N Mini
Torque	NA cm.N Mini
RECOMMENDED TORQUES	
Mating	NA cm.N
Panel nut	150 cm.N
Clamp nut	NA cm.N

CONNECTOR PARTS	MATERIALS	FINISH	(all values are given in micrometers)
BODY	BRASS	BBR 2	
OUTER CONTACT			
CENTER CONTACT	BERYLLIUM COPPER	GOLD 1.3 OVER COPPER 2.5	
INSULATOR	PTFE	-	
GASKET		-	
OTHERS PIECES	BRASS	BBR 2	

TRIQUES

ISSUE	CREATION DATE	FILE PART-NUMBER
9847A00	02/12/1996	96-1000-017



RADIALL®

The information given here is subject to change without notice.
Design changes may be in order to improve the product .

Connect to the future



R124.313.120

ISSUE 9847A00 SERIES SMA-COM

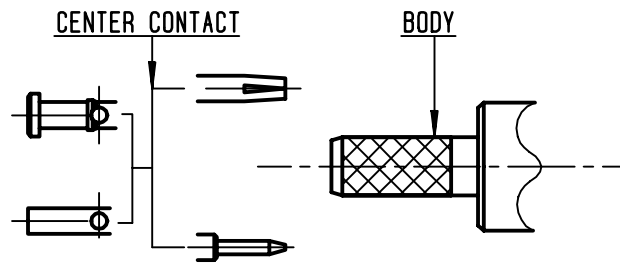
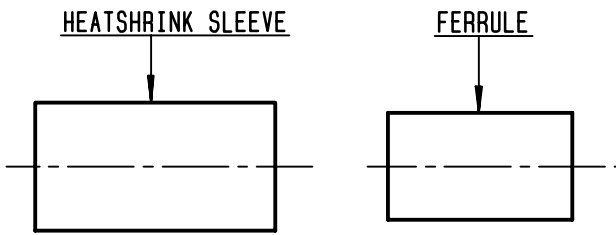

①

Slide heatshrink sleeve (R280.637.020-Option) and ferrule onto cable. Strip the cable.

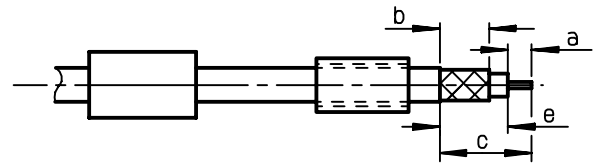

Stripping	a	b	c	d	e
inch	0.118	0.248	0.425	0	0.307
mm	3	6.3	10.8		7.8

②

Slide center contact on until it bottoms against cable dielectric. Solder or crimp center contact. Crimping tool : R282.281.000 (2 x 4 pts) position 5 + positionner R282.967.012.

SOLDER / CRIMPING

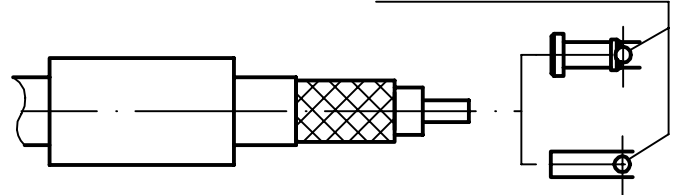

③

Fan the braid. Slide cable into the body by overtaking the insulator hard mounting point. Slide ferrule over the braid. (In direction F)

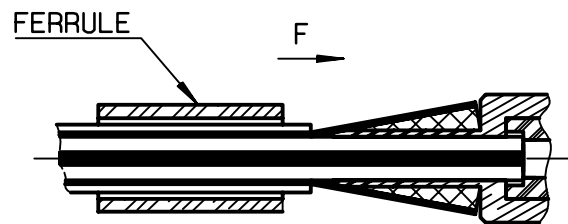

④

Crimp the ferrule with crimping tool R282.271.000 (Hex. : .151)(3.84) or crimping tool R282.293.000 (M22520/5-01) + dies R282.235.037 (M22520/5-37) Cut excess of braid if necessary. Slide sleeve over ferrule and heatshrink in place (Option)

Shrink the heatshrink sleeve

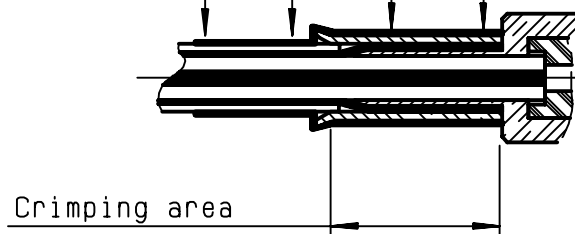

TRIQUES