

M8 female 90° with cable LED

PUR 4x0.25 bk UL/CSA+drag chain 2m

M8

Female 90°

4-pole with 3 × LED (PNP)

Plastic housings with good resistance against chemicals and oils. The resistance to aggressive media should be individually tested for your application. Further details on request. Further cable lengths on request.

[Link to Product](#)

Illustration

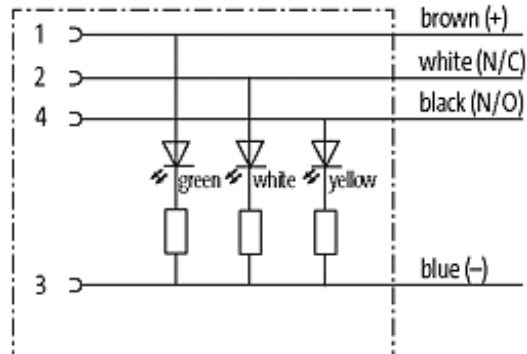

Female

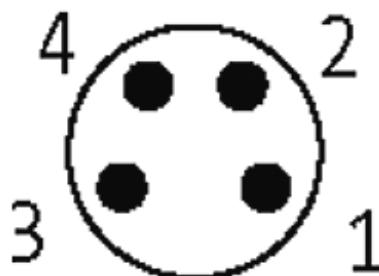

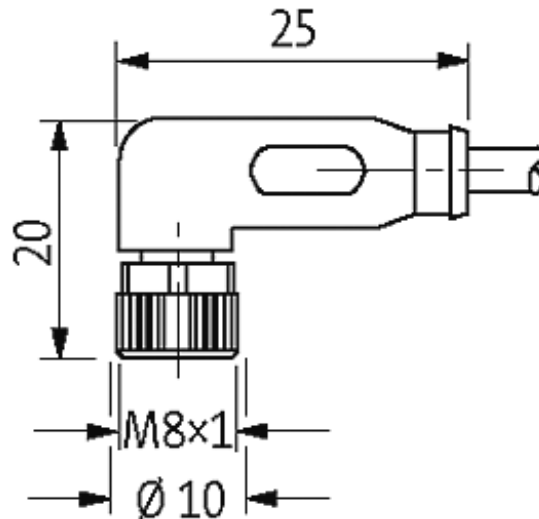

Product may differ from Image

Approvals



* only for products with UL/CSA approved cable

Form

08141

Technical Data

Operating voltage	24 V DC $\pm 25\%$
Operating current per contact	max. 4 A
Locking of ports	Screw thread M8 \times 1 mm (recommended torque 0.4 Nm) self-securing
Protection	IP67 inserted and tightened (EN 60529)

Cables

Cable number	631
No./diameter of wires	4 \times 0.25 mm ²
Wire isolation	PP (br, wh, bl, bk)
C-track properties	5 Mio.
Torsion	2 Mio. \pm 180°/m
Jacket Color	black
Shore hardness outer jacket	90 \pm 5A
Material (jacket)	PUR (UL/CSA)
Outer diameter	approx. 4.7 mm
Bend radius (fixed)	5 \times outer \varnothing
Bend radius (moving)	10 \times outer \varnothing

Temperature range (fixed)	-40...+80 °C
Temperature range (mobile)	-25...+80 °C

Commercial data

country of origin	DE
customs tariff number	85444290
minimum order quantity	1