

MCOB128064JX-BM	128 x 64	OLED Module
Specification		
Version: 1	Date: 05/05/2016	
Revision		
1	05/05/2016	First Issue

Display Features			Box Quantity	Weight / Display
Resolution	128 x 64			
Appearance	Blue on Black			
Logic Voltage	3/5V			
Interface	Multi			
Module Size	75.00 x 52.70 x 7.50mm			
Operating Temperature	-40°C ~ +80°C			
Construction	COB			

* - For full design functionality, please use this specification in conjunction with the SSD1309 specification. (Provided Separately)

Display Accessories	
Part Number	Description

Optional Variants	
Appearance	Voltage



Functions and Features

- 128 X 64 Graphic
- Built-in controller
- viewing angle Free
- Wide Temperature -40°C ~ +80°C (Operating)
- RoHS compliant

Mechanical Specification

Item	Description	
Product No.	MCOB128064JX-BM	
Inch	2.42"	
Color	Blue	
Active Area	55.01(W)×27.49(H)	mm
Module Size	75.00(W)×52.70(H)×7.50(D)	mm
Dot Size	0.40(W)×0.40(H)	mm
Dot Pitch	0.43(W)×0.43(H)	mm
Display Format	128×64	
Duty Ratio	1/64 Duty	Duty
Controller	SSD1309 or Equivalent	
Operation Temperature	-40~80	°C
Storage Temperature	-40~85	°C
Response Time	≤10	us



IF1	SYMBOL
1	VDD
2	VSS
3	NC
4-11	DB0-7
12	CS#
13	NC
14	RESS#
15	R/W#
16	D/C#
17	E/RD#
18	NC
19	DISP
20	NC

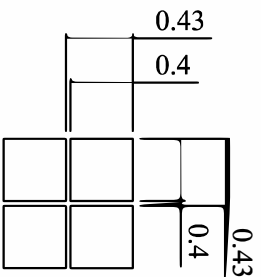
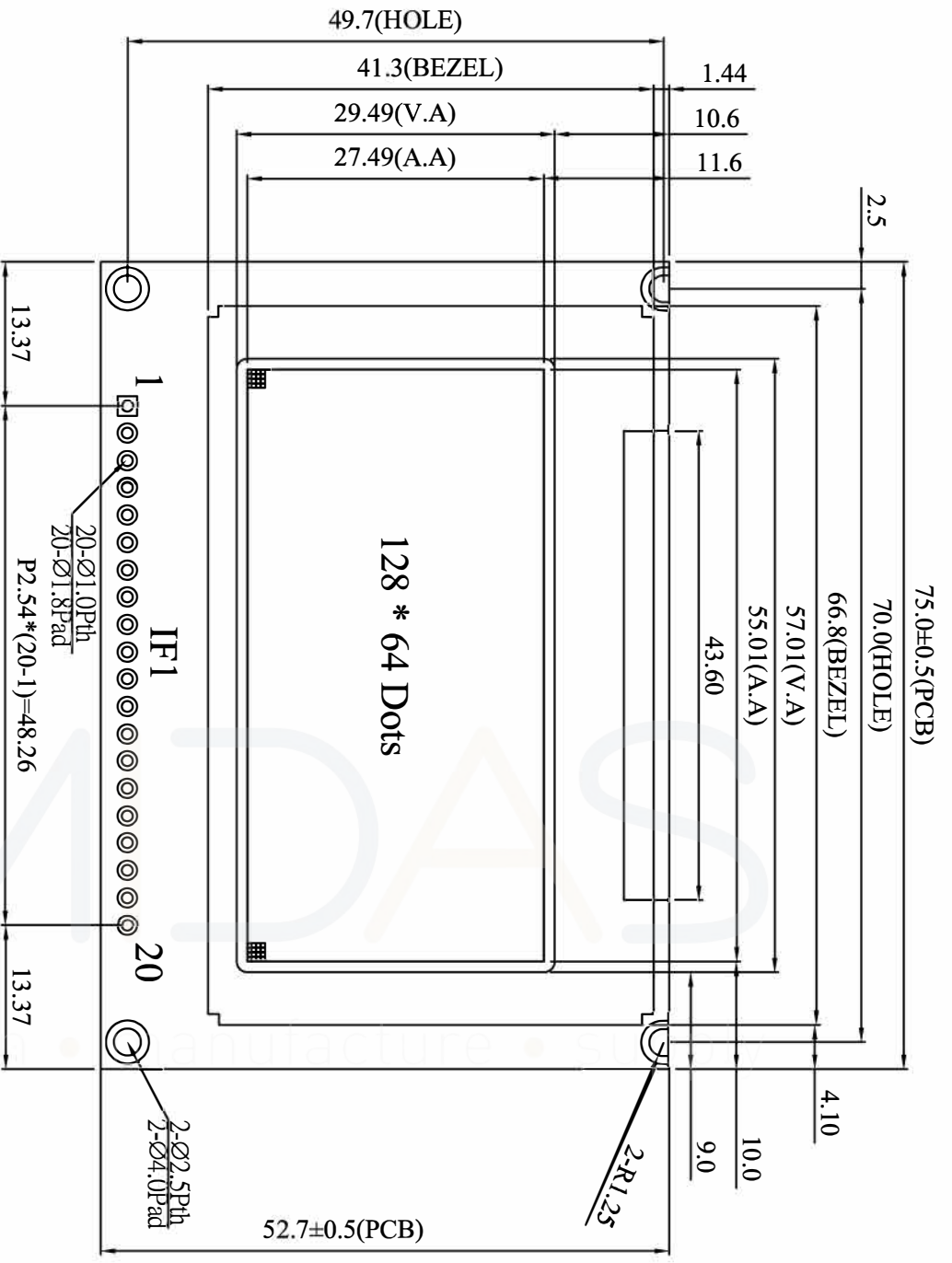

DOT SIZE
SCALE 20/1

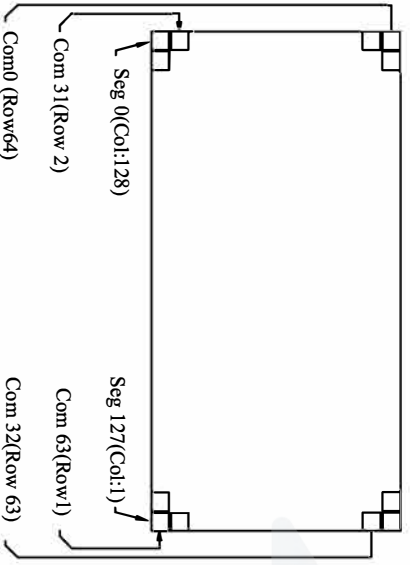

Projection Type		Tolerance		MODEL		Drawing Number		Rev.	
		±0.3		MCOB128064JX-BM				A	
Drawn		Unit		TITLE					
Checked		mm		OLED Module Drawing					
Eco-2048		Eco-1500		Scale		Sheet		Size	
2048.00		1500.00		3/2		1 of 1		A4	
Eco-0150		Eco-0097							
1500.00		0150.00							
Note		0097.00							
2048.00		0097.00							

Pin Description

Power Supply

Pin No.	Symbol	Level	Description
1	VDD	3~5V	Supply voltage for logic
2	VSS	0V	Ground
3	NC	-	No connection
4~11	DB0~DB7	H/L	Data bus line
12	/CS	H/L	Chip select pin
13	NC	-	No connection
14	/RES	H/L	Hardware reset pin
15	WR	H/L	8080: data write enable pin 6800: Read/Write select pin
16	RS	H/L	H: Data; L: Command.
17	RD	H/L	8080: data read enable pin 6800: Read/Write enable pin
18	NC	-	No connection
19	DISP	H/L	L:OLEDM display off H or NC: display on
20	NC	-	No connection

※80 Series Interface is Default (6800.SERIAL.I2C interface is option)

Table: MCU Bus Interface Pin Selection

Pin Name.	I ₂ C Interface	6800- parallel interface	8080- parallel interface	Serial interface
JB1	1(H)	0(L)	1(H)	0(L)
JB2	0(L)	1(H)	1(H)	0(L)

Note

(1) 0 (L) is connected to VSS

(2) 1 (H) is connected to VDD



DC Characteristics

Item	Symbol	Condition	Min.	Type	Max.	Unit
Supply Voltage for Logic	VDD - VSS	-	1.65	3~5	5.3	Volt
Input High Volt.	VIH	-	0.8 VDD	-	-	Volt
Input Low Volt.	VIL	-	-	-	0.2 VDD	Volt
Output High Volt.	VOH	-	0.9 VDD	-	-	Volt
Output Low Volt.	VOL	-	-	-	0.1 VDD	Volt
Supply Current	IDD	-	-	120	-	mA

Optical Characteristics

Item	Symbol	Conditions	Min.	Typ	Max.	Unit
Brightness	Lbr	-	-	80	-	cd/m ²
C.I.E.	(X)	C.I.E 1931	0.12	0.16	0.20	
	(Y)		0.22	0.26	0.30	
Dark Room Contrast	CR	-	-	>10000:1	-	
Viewing angle range	-	-	-	Free	-	Degree

Absolute Maximum rating

Item	Symbol	Min.	Typ.	Max.	Unit	Notes
Supply Voltage for Logic	VDD	-0.3	-	5.5	Volt	
Life Time (40 cd/m ²)		---	70,000	---	Hour	

AC Characteristics

Please refer "SSD1309 specification.



Actual Application Example

Command usage and explanation of an actual example

<Power up Sequence>

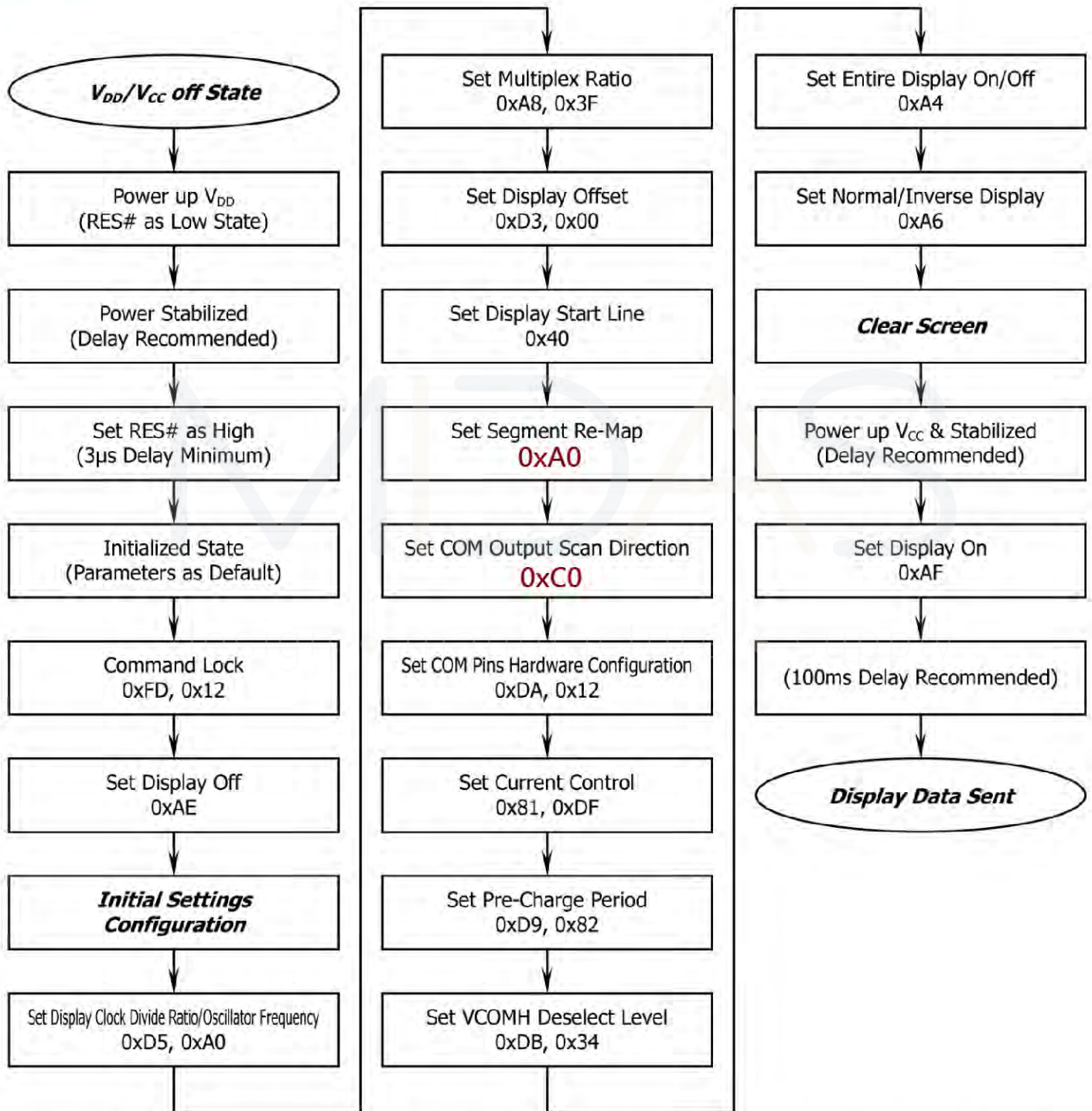

If the noise is accidentally occurred at the displaying window during the operation, please reset the display in order to recover the display function.



<Power down Sequence>

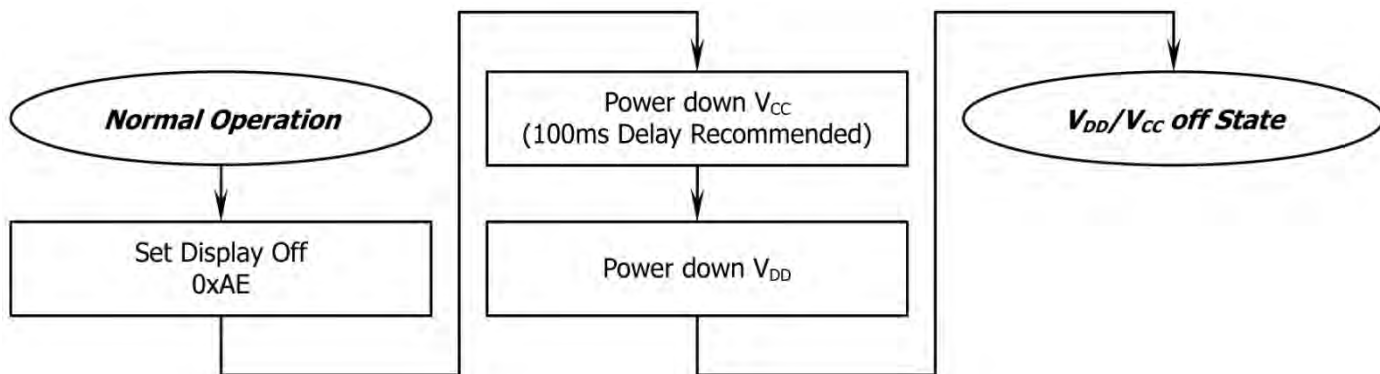

<Entering Sleep Mode>

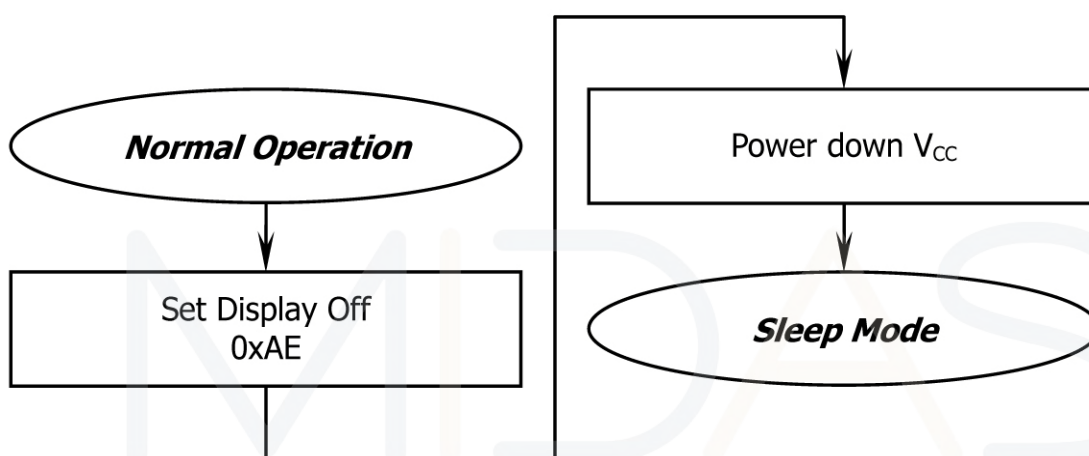

<Exiting Sleep Mode>

