

FEATURES

- Temperature Measurements Require No External Components
- Measures Temperatures from -55°C to +125°C (-67°F to +257°F)
- ±2°C Accuracy Over a -25°C to +100°C Range
- Thermometer Resolution is User-Configurable from Nine (Default) to 12 Bits (0.5°C to 0.0625°C Resolution)
- 9-Bit Conversion Time is 150ms (Max)
- Thermostatic Settings are User-Definable
- Data is Read/Written Via 2-Wire Serial Interface (SDA and SCL Pins)
- Multidrop Capability Simplifies Distributed Temperature-Sensing Applications
- Wide Power-Supply Range (+2.7V to +5.5V).
- Pin/software Compatible with the LM75
- Available in 8-Pin μMAX® and SO Packages. See Table 1 for Ordering Information
- Applications Include Personal Computers, Cellular Base Stations, Office Equipment, or Any Thermally Sensitive System

PIN ASSIGNMENT

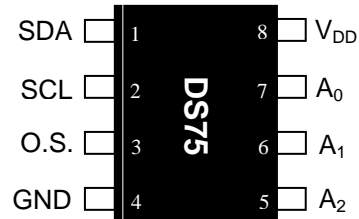

DS75S+ (8-Pin SO — 150mil)

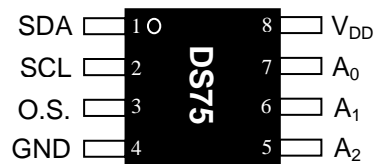

DS75U+ (μMAX)

PIN DESCRIPTION

- SDA – Open-Drain Data I/O
- SCL – Clock Input
- GND – Ground
- O.S. – Open-Drain Thermostat Output
- A₀ – Address Input
- A₁ – Address Input
- A₂ – Address Input
- V_{DD} – Power Supply

DESCRIPTION

The DS75 digital thermometer and thermostat provides 9, 10, 11, or 12-bit digital temperature readings over a -55°C to +125°C range with ±2°C accuracy over a -25°C to +100°C range. At power-up, the DS75 defaults to 9-bit resolution for software compatibility with the LM75. Communication with the DS75 is achieved via a simple 2-wire serial interface. Three address pins allow up to eight DS75 devices to operate on the same 2-wire bus, which greatly simplifies distributed temperature sensing applications.

The DS75 thermostat has a dedicated open-drain output (O.S.) and programmable fault tolerance, which allows the user to define the number of consecutive error conditions that must occur before O.S is activated. There are two thermostatic operating modes that control thermostat operation based on user-defined trip-points (T_{OS} and T_{HYST}).

A block diagram of the DS75 is shown in Figure 1 and detailed pin descriptions are given in Table 2.

μMAX is a registered trademark of Maxim Integrated Products, Inc.

Table 1. ORDERING INFORMATION

ORDERING NUMBER	PACKAGE MARKING	DESCRIPTION
DS75S+	DS75 (see note)	DS75 in Lead-Free 150mil 8-Pin SO
DS75S+T&R	DS75 (see note)	DS75 in Lead-Free 150mil 8-Pin SO, 2500-Piece Tape-and-Reel
DS75U+	DS75 (see note)	DS75 in Lead-Free 8-Pin μ MAX
DS75U+T&R	DS75 (see note)	DS75 in Lead-Free 8-Pin μ MAX, 3000-Piece Tape-and-Reel
DS75S	DS75	DS75 in 150mil 8-Pin SO
DS75S/T&R	DS75	DS75 in 150mil 8-Pin SO, 2500-Piece Tape-and-Reel
DS75U	DS75	DS75 in 8-Pin μ MAX
DS75U/T&R	DS75	DS75 in 8-Pin μ MAX, 3000-Piece Tape-and-Reel

Note: A "+" symbol will also be marked on the package near the Pin 1 indicator

Table 2. DETAILED PIN DESCRIPTION

PIN	SYMBOL	DESCRIPTION
1	SDA	Data input/output pin for 2-wire serial communication port. Open drain.
2	SCL	Clock input pin for 2-wire serial communication port.
3	O.S.	Thermostat output. Open drain.
4	GND	Ground pin.
5	A ₂	Address input pin.
6	A ₁	Address input pin.
7	A ₀	Address input pin.
8	V _{DD}	Supply Voltage. +2.7V to +5.5V supply pin.

Figure 1. DS75 FUNCTIONAL BLOCK DIAGRAM

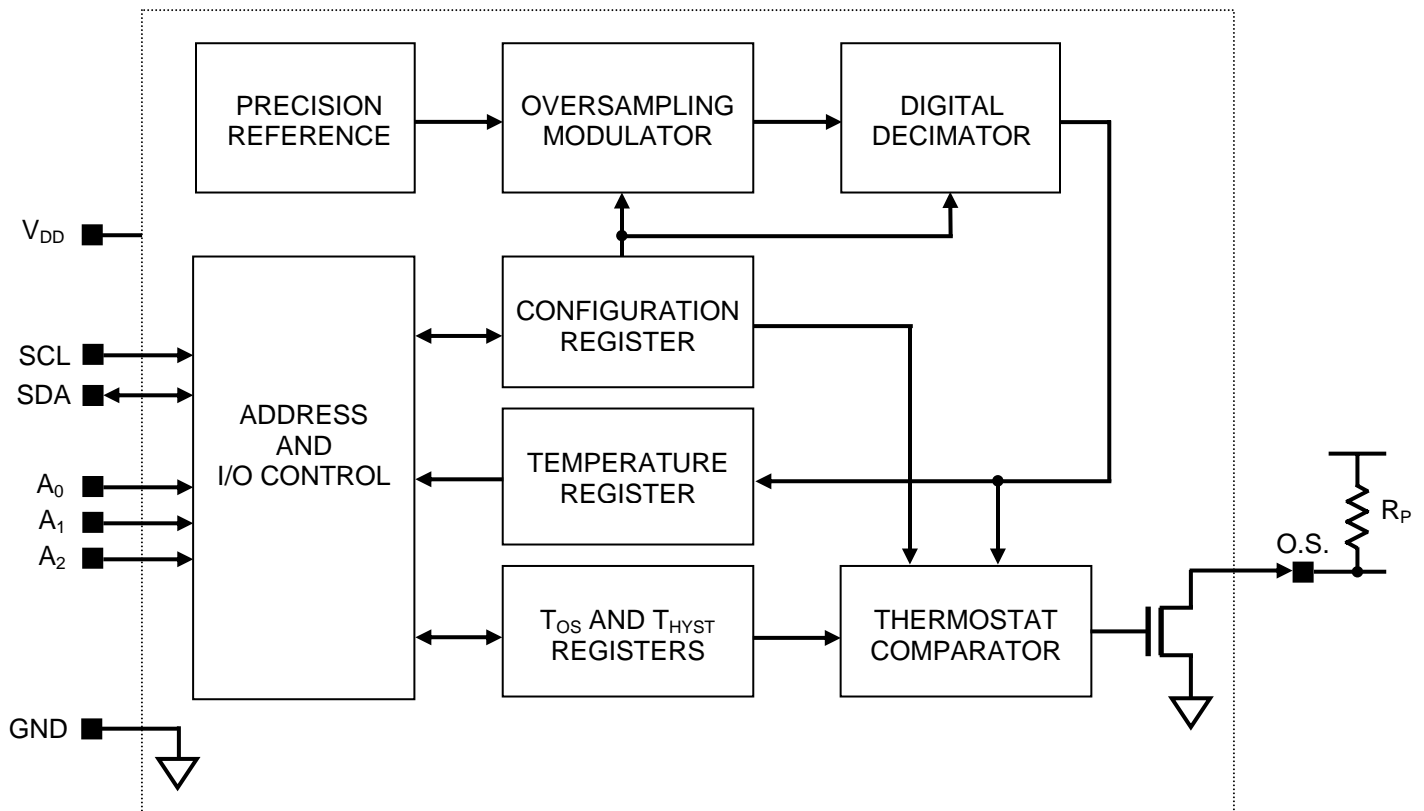

ABSOLUTE MAXIMUM RATINGS*

Voltage on V_{DD} , Relative to Ground	-0.3V to +7.0V
Voltage on any other pin, Relative to Ground	-0.3V to ($V_{DD} + 0.3V$)
Operating Temperature	-55°C to +125°C
Storage Temperature	-55°C to +125°C
Soldering Temperature	+260°C for 10 seconds

* These are stress ratings only and functional operation of the device at these or any other conditions above those indicated in the operation sections of this specification is not implied. Exposure to absolute maximum rating conditions for extended periods of time may affect reliability.

DC ELECTRICAL CHARACTERISTICS (-55°C to $+125^{\circ}\text{C}$; $2.7\text{V} \leq V_{DD} \leq 5.5\text{V}$)

PARAMETER	SYMBOL	CONDITION	MIN	MAX	UNITS	NOTES
Supply Voltage	V_{DD}		2.7	5.5	V	
Thermometer Error	T_{ERR}	-25 to +100		± 2.0	°C	2
		-55 to +125		± 3.0		
Input Logic High	V_{IH}		$0.7V_{DD}$	$V_{DD}+0.5$	V	1
Input Logic Low	V_{IL}		-0.5	$0.3V_{DD}$	V	1
SDA Output Logic Low Voltage	V_{OL1}	3 mA sink current	0	0.4	V	1
	V_{OL2}	6 mA sink current	0	0.6		
O.S. Saturation Voltage	V_{OL}	4 mA sink current		0.8	V	1, 2
Input current each I/O pin		$0.4 < V_{I/O} < 0.9 V_{DD}$	-10	+10	μA	
I/O Capacitance	$C_{I/O}$			10	pF	
Standby Current	I_{DD1}			1	μA	3, 4
Active Current	I_{DD}	Active Temp. Conversions		1000	μA	3, 4
		Communication only		100		

AC ELECTRICAL CHARACTERISTICS (-55°C to +125°C; 2.7V ≤ V_{DD} ≤ 5.5V)

PARAMETER	SYMBOL	CONDITION	MIN	TYP	MAX	UNITS	NOTES
Resolution			9		12	bits	
Temperature Conversion Time	t _{CONVT}	9-bit conversions			150	ms	
		10-bit conversions			300		
		11-bit conversions			600		
		12-bit conversions			1200		
SCL Frequency	f _{SCL}				400	KHz	
Bus Free Time Between a STOP and START Condition	t _{BUF}		1.3			μs	5
START and Repeated START Hold Time from Falling SCL	t _{HD:STA}		0.6			μs	5, 6
Low Period of SCL	t _{LOW}		1.3			μs	5
High Period of SCL	t _{HIGH}		0.6			μs	5
Repeated START Condition Setup Time to Rising SCL	t _{SU:STA}		0.6			μs	5
Data-Out Hold Time from Falling SCL	t _{HD:DAT}		0		0.9	μs	5
Data-In Setup Time to Rising SCL	t _{SU:DAT}		100			ns	5
Rise Time of SDA and SCL	t _R		20 + 0.1C _B		1000	ns	5, 7
Fall Time of SDA and SCL	t _F		20 + 0.1C _B		300	ns	5, 7
STOP Setup Time to Rising SCL	t _{SU:STO}		0.6			μs	5
Capacitive Load for Each Bus Line	C _B				400	pF	
Input Capacitance	C _I			5		pF	

NOTES:

- All voltages are referenced to ground.
- Internal heating caused by O.S. loading will cause the DS75 to read approximately 0.5°C higher if O.S. is sinking the max rated current.
- I_{DD} specified with O.S. pin open.
- I_{DD} specified with V_{DD} at 5.0V and SDA, SCL = 5.0V, 0°C to 70°C.
- See Timing Diagram in Figure 2. All timing is referenced to 0.9 x V_{DD} and 0.1 x V_{DD}.
- After this period, the first clock pulse is generated.
- For example, if C_B = 300pF, then t_R[min] = t_F[min] = 50ns.

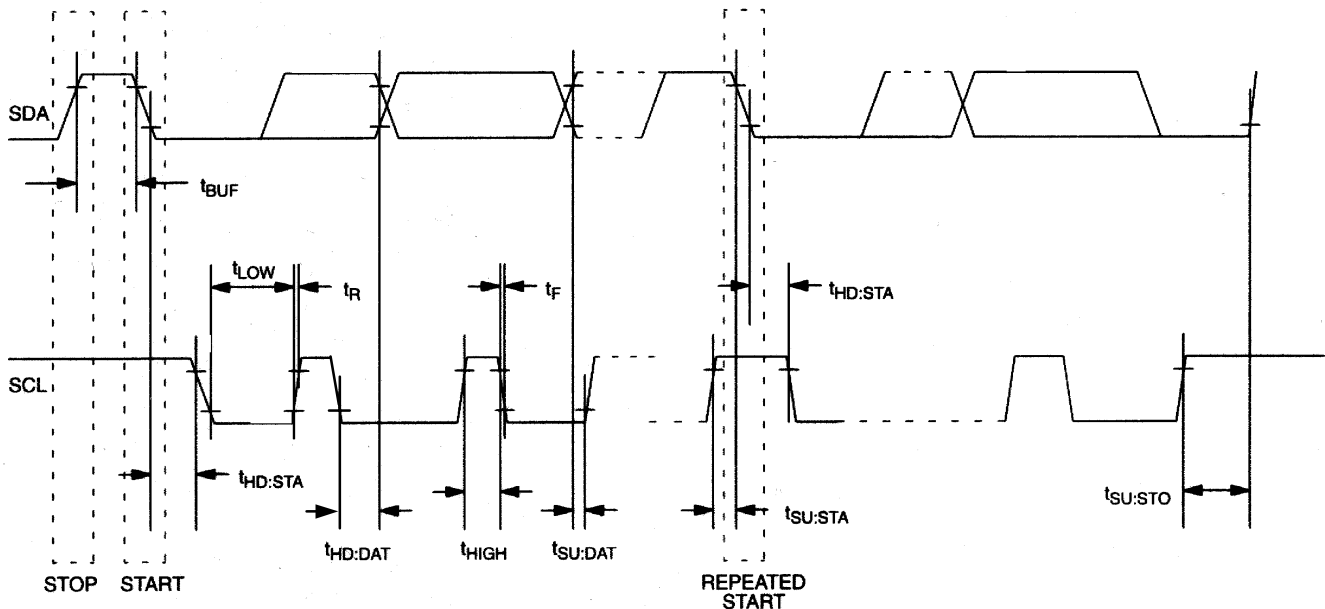
Figure 2. TIMING DIAGRAM

Note: The DS75 does not delay the SDA line internally with respect to SCL for any length of time.

OPERATION—MEASURING TEMPERATURE

The DS75 measures temperature using a bandgap temperature sensing architecture. An on-board delta-sigma analog-to-digital converter (ADC) converts the measured temperature to a digital value that is calibrated in degrees centigrade; for Fahrenheit applications a lookup table or conversion routine must be used. The DS75 is factory-calibrated and requires no external components to measure temperature.

At power-up the DS75 immediately begins measuring the temperature and converting the temperature to a digital value. The resolution of the digital output data is user-configurable to 9, 10, 11, or 12 bits, corresponding to temperature increments of 0.5°C, 0.25°C, 0.125°C, and 0.0625°C, respectively, with 9-bit default resolution at power-up. The resolution is controlled via the R0 and R1 bits in the configuration register as explained in the *CONFIGURATION REGISTER* section of this data sheet. Note that the conversion time doubles for each additional bit of resolution.

After each temperature measurement and analog-to-digital conversion, the DS75 stores the temperature as a 16-bit two's complement number in the 2-byte temperature register (see Figure 3). The sign bit (S) indicates if the temperature is positive or negative: for positive numbers $S = 0$ and for negative numbers $S = 1$. The most recently converted digital measurement can be read from the temperature register at any time. Since temperature conversions are performed in the background, reading the temperature register does not affect the operation in progress.

Bits 3 through 0 of the temperature register are hardwired to 0. When the DS75 is configured for 12-bit resolution, the 12 MSBs (bits 15 through 4) of the temperature register will contain temperature data. For 11-bit resolution, the 11 MSBs (bits 15 through 5) of the temperature register will contain data, and bit 4 will read out as 0. Likewise, for 10-bit resolution, the 10 MSBs (bits 15 through 6) will contain data, and for 9-bit the 9 MSBs (bits 15 through 7) will contain data, and all unused LSBs will contain 0s. Table 3 gives examples of 12-bit resolution digital output data and the corresponding temperatures.

Figure 3. TEMPERATURE, T_H , and T_L REGISTER FORMAT

	bit 15	bit 14	bit 13	bit 12	bit 11	bit 10	bit 9	bit 8
MS Byte	S	2^6	2^5	2^4	2^3	2^2	2^1	2^0
	bit 7	bit 6	bit 5	bit 4	bit 3	bit 2	bit 1	bit 0
LS Byte	2^{-1}	2^{-2}	2^{-3}	2^{-4}	0	0	0	0

Table 3. 12-BIT RESOLUTION TEMPERATURE/DATA RELATIONSHIP

TEMPERATURE (°C)	DIGITAL OUTPUT (BINARY)	DIGITAL OUTPUT (HEX)
+125	0111 1101 0000 0000	7D00h
+25.0625	0001 1001 0001 0000	1910h
+10.125	0000 1010 0010 0000	0A20h
+0.5	0000 0000 1000 0000	0080h
0	0000 0000 0000 0000	0000h
-0.5	1111 1111 1000 0000	FF80h
-10.125	1111 0101 1110 0000	F5E0h
-25.0625	1110 0110 1111 0000	E6F0h
-55	1100 1001 0000 0000	C900h

SHUTDOWN MODE

For power-sensitive applications, the DS75 offers a low-power shutdown mode. The SD bit in the configuration register controls shutdown mode. When SD is changed to 1, the conversion in progress will be completed and the result stored in the temperature register after which the DS75 will go into a low-power standby state. The O.S. output will be cleared if the thermostat is operating in interrupt mode and O.S will remain unchanged in comparator mode. The 2-wire interface remains operational in shutdown mode, and writing a 0 to the SD bit returns the DS75 to normal operation.

OPERATION—THERMOSTAT

The DS75 thermostat has two operating modes, comparator mode and interrupt mode, which activate and deactivate the open-drain thermostat output (O.S.) based on user-programmable trip-points (T_{OS} and T_{HYST}). The DS75 powers up with the thermostat in comparator mode with active-low O.S. polarity and with the over-temperature trip-point (T_{OS}) register set to 80°C and the hysteresis trip-point (T_{HYST}) register set to 75°C. If these power-up settings are compatible with the application, the DS75 can be used as a standalone thermostat (i.e., no 2-wire communication required). If interrupt mode operation, active-high O.S. polarity or different T_{OS} and T_{HYST} values are desired, they must be programmed after power-up, so standalone operation is not possible.

In both operating modes, the user can program the thermostat fault tolerance, which sets how many consecutive temperature readings (1, 2, 4, or 6) must fall outside of the thermostat limits before the thermostat output is triggered. The fault tolerance is set by the F1 and F0 bits in the configuration and at power-up the fault tolerance is 1.

The data format of the T_{OS} and T_{HYST} registers is identical to that of the temperature register (see Figure 3), i.e., a two-byte two's complement representation of the trip-point temperature in degrees centigrade with bits 3 through 0 hardwired to 0. After every temperature conversion, the measured temperature is

compared to the values in the T_{OS} and T_{HYST} registers, and then O.S. is updated based on the result of the comparison and the operating mode. The number of T_{OS} and T_{HYST} bits used during the thermostat comparison is equal to the conversion resolution set by the R1 and R0 bits in the configuration register. For example, if the resolution is 9 bits, only the 9 MSBs of T_{OS} and T_{HYST} will be used by the thermostat comparator.

The active state of the O.S. output can be changed via the POL bit in the configuration register. The power-up default is active low.

If the user does not wish to use the thermostat capabilities of the DS75, the O.S. output should be left floating. Note that if the thermostat is not used, the T_{OS} and T_{HYST} registers can be used for general storage of system data.

Comparator Mode — When the thermostat is in comparator mode, O.S. can be programmed to operate with any amount of hysteresis. The O.S. output becomes active when the measured temperature exceeds the T_{OS} value a consecutive number of times as defined by the F1 and F0 fault tolerance (FT) bits in the configuration register. O.S. then stays active until the first time the temperature falls below the value stored in T_{HYST} . Putting the device into shutdown mode does not clear O.S. in comparator mode. Thermostat comparator mode operation with $FT = 2$ is illustrated in Figure 4.

Interrupt Mode — In interrupt mode, the O.S. output first becomes active when the measured temperature exceeds the T_{OS} value a consecutive number of times equal to the FT value in the configuration register. Once activated, O.S. can only be cleared by either putting the DS75 into shutdown mode or by reading from any register (temperature, configuration, T_{OS} , or T_{HYST}) on the device. Once O.S. has been deactivated, it will only be reactivated when the measured temperature falls below the T_{HYST} value a consecutive number of times equal to the FT value. Again, O.S. can only be cleared by putting the device into shutdown mode or reading any register. Thus, this interrupt/clear process is cyclical between T_{OS} and T_{HYST} events (i.e., T_{OS} , clear, T_{HYST} , clear, T_{OS} , clear, T_{HYST} , clear, etc.). Thermostat interrupt mode operation with $FT = 2$ is illustrated in Figure 4.

Figure 4. O.S. OUTPUT OPERATION EXAMPLE

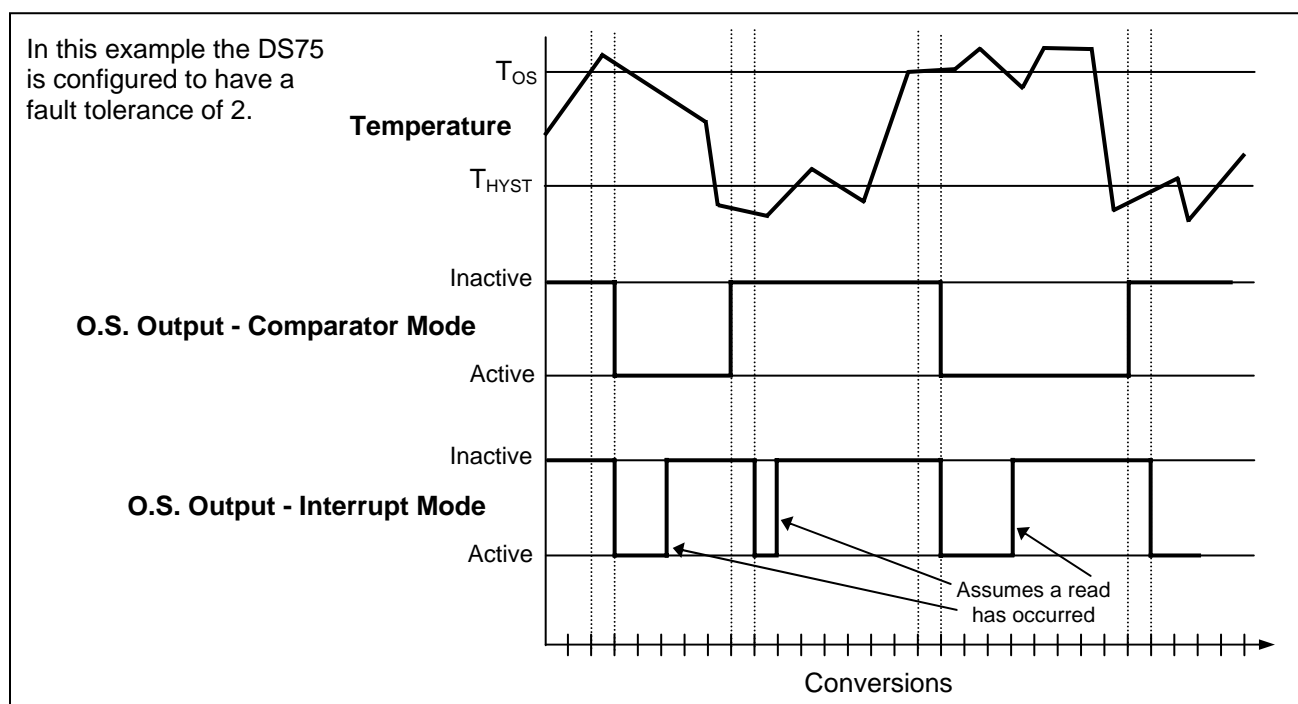

CONFIGURATION REGISTER

The configuration register allows the user to program various DS75 options such as conversion resolution, thermostat fault tolerance, thermostat polarity, thermostat operating mode, and shutdown mode. The configuration register is arranged as shown in Figure 5 and detailed descriptions of each bit are provided in Table 4. The user has read/write access to all bits in the configuration register except the MSb, which is a reserved read-only bit. The entire register is volatile, and thus powers-up in its default state.

Figure 5. CONFIGURATION REGISTER

MSb	bit 6	bit 5	bit 4	bit 3	bit 2	bit 1	LSb
0	R1	R0	F1	F0	POL	TM	SD

Table 4. CONFIGURATION REGISTER BIT DESCRIPTIONS

BIT NAME	FUNCTIONAL DESCRIPTION
0 Reserved	Power-up state = 0 The master can write to this bit, but it will always read out as a 0.
R1 Conversion Resolution Bit 1	Power-up state = 0 Sets conversion resolution (see Table 5)
R0 Conversion Resolution Bit 0	Power-up state = 0 Sets conversion resolution (see Table 5)
F1 Thermostat Fault Tolerance Bit 1	Power-up state = 0 Sets the thermostat fault tolerance (see Table 6).
F0 Thermostat Fault Tolerance Bit 0	Power-up state = 0 Sets the thermostat fault tolerance (see Table 6).
POL Thermostat Output (O.S.) Polarity	Power-up state = 0 POL = 0 — O.S. is active low. POL = 1 — O.S. is active high.
TM Thermostat Operating Mode	Power-up state = 0 TM = 0 — Comparator mode. TM = 1 — Interrupt mode. See the <i>OPERATION–Thermostat</i> section for a detailed description of these modes.
SD Shutdown	Power-up state = 0 SD = 0 — Active conversion and thermostat operation. SD = 1 — Shutdown mode. See the <i>SHUTDOWN MODE</i> section for a detailed description of this mode.

Table 5. RESOLUTION CONFIGURATION

R1	R0	THERMOMETER RESOLUTION	MAX CONVERSION TIME
0	0	9-bit	150 ms
0	1	10-bit	300 ms
1	0	11-bit	600 ms
1	1	12-bit	1200 ms

Table 6. Fault Tolerance Configuration

F1	F0	CONSECUTIVE OUT-OF-LIMITS CONVERSIONS TO TRIGGER O.S.
0	0	1
0	1	2
1	0	4
1	1	6

REGISTER POINTER

The four DS75 registers each have a unique two-bit pointer designation, which is defined in Table 7. When reading from or writing to the DS75, the user must “point” the DS75 to the register that is to be accessed. When reading from the DS75, once the pointer is set, it will remain pointed at the same register until it is changed. For example, if the user desires to perform consecutive reads from the temperature register, then the pointer only has to be set to the temperature register one time, after which all reads will automatically be from the temperature register until the pointer value is changed. On the other hand, when writing to the DS75, the pointer value must be refreshed each time a write is performed even if the same register is being written to twice in a row.

At power-up, the default pointer value is the temperature register so the temperature register can be read immediately without resetting the pointer.

Changes to the pointer setting are accomplished as described in the *2-WIRE SERIAL DATA BUS* section of this datasheet.

Table 7. POINTER DEFINITION

REGISTER	P1	P0
Temperature	0	0
Configuration	0	1
T _{HYST}	1	0
T _{OS}	1	1

2-WIRE SERIAL DATA BUS

The DS75 communicates over a standard bi-directional 2-wire serial data bus that consists of a serial clock (SCL) signal and serial data (SDA) signal. The DS75 interfaces to the bus via the SCL input pin and open-drain SDA I/O pin. All communication is MSb first.

The following terminology is used to describe 2-wire communication:

Master Device: Microprocessor/microcontroller that controls the slave devices on the bus. The master device generates the SCL signal and START and STOP conditions.

Slave: All devices on the bus other than the master. The DS75 always functions as a slave.

Bus Idle or Not Busy: Both SDA and SCL remain high. SDA is held high by a pullup resistor when the bus is idle, and SCL must either be forced high by the master (if the SCL output is push-pull) or pulled high by a pullup resistor (if the SCL output is open-drain).

Transmitter: A device (master or slave) that is sending data on the bus.

Receiver: A device (master or slave) that is receiving data from the bus.

START Condition: Signal generated by the master to indicate the beginning of a data transfer on the bus. The master generates a START condition by pulling SDA from high to low while SCL is high (see Figure 6). A “repeated” START is sometimes used at the end of a data transfer (instead of a STOP) to indicate that the master will perform another operation.

STOP Condition: Signal generated by the master to indicate the end of a data transfer on the bus. The master generates a STOP condition by transitioning SDA from low to high while SCL is high (see Figure 6). After the STOP is issued, the master releases the bus to its idle state.

Acknowledge (ACK): When a device (either master or slave) is acting as a receiver, it must generate an acknowledge (ACK) on the SDA line after receiving every byte of data. The receiving device performs an ACK by pulling the SDA line low for an entire SCL period (see Figure 6). During the ACK clock cycle, the transmitting device must release SDA. A variation on the ACK signal is the “not acknowledge” (NACK). When the master device is acting as a receiver, it uses a NACK instead of an ACK after the last data byte to indicate that it is finished receiving data. The master indicates a NACK by leaving the SDA line high during the ACK clock cycle.

Slave Address: Every slave device on the bus has a unique 7-bit address that allows the master to access that device. The DS75’s 7-bit bus address is 1 0 0 1 A_2 A_1 A_0 , where A_2 , A_1 and A_0 are user-selectable via the corresponding input pins. The three address pins allow up to eight DS75s to be multi-dropped on the same bus.

Address Byte: The control byte is transmitted by the master and consists of the 7-bit slave address plus a read/write (R/\overline{W}) bit (see Figure 7). If the master is going to read data from the slave device then $R/\overline{W} = 1$, and if the master is going to write data to the slave device then $R/\overline{W} = 0$.

Pointer Byte: The pointer byte is used by the master to tell the DS75 which register is going to be accessed during communication. The six LSBs of the pointer byte (see Figure 8) are always 0 and the two LSBs correspond to the desired register as shown in Table 7.

Figure 6. START, STOP, AND ACK SIGNALS

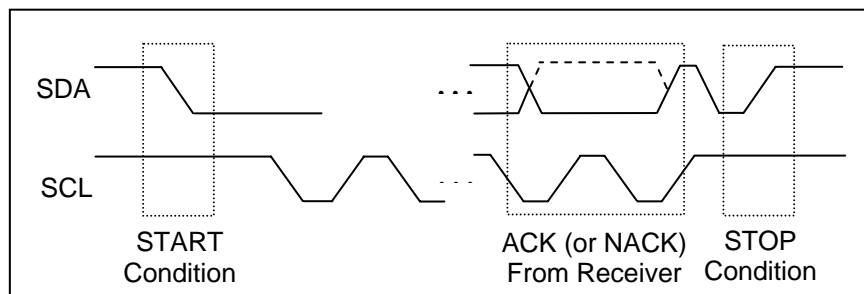

Figure 7. ADDRESS BYTE

bit 7	bit 6	bit 5	bit 4	bit 3	bit 2	bit 1	bit 0
1	0	0	1	A_2	A_1	A_0	R/\overline{W}

Figure 8. POINTER BYTE

bit 7	bit 6	bit 5	bit 4	bit 3	bit 2	bit 1	bit 0
0	0	0	0	0	0	0	0

0	0	0	0	0	0	P1	P0
---	---	---	---	---	---	----	----

GENERAL 2-WIRE INFORMATION

- All data is transmitted MSb first over the 2-wire bus.
- One bit of data is transmitted on the 2-wire bus each SCL period.
- A pullup resistor is required on the SDA line and, when the bus is idle, both SDA and SCL must remain in a logic-high state.
- All bus communication must be initiated with a START condition and terminated with a STOP condition. During a START or STOP is the only time SDA is allowed to change states while SCL is high. At all other times, changes on the SDA line can only occur when SCL is low: SDA must remain stable when SCL is high.
- After every 8-bit (1-byte) transfer, the receiving device must answer with an ACK (or NACK), which takes one SCL period. Therefore, nine clocks are required for every one-byte data transfer.

Writing to the DS75—To write to the DS75, the master must generate a START followed by an address byte containing the DS75 bus address. The value of the R/W bit must be a 0, which indicates that a write is about to take place. The DS75 will respond with an ACK after receiving the address byte. This must be followed by a pointer byte from the master, which tells the DS75 which register is being written to. The DS75 will again respond with an ACK after receiving the pointer byte. Following this ACK the master device must immediately begin transmitting data to the DS75. When writing to the configuration register, the master must send one byte of data (see Figure 9a), and when writing to the T_{OS} or T_{HYST} registers the master must send two bytes of data (see Figure 9b). After receiving each data byte, the DS75 will respond with an ACK, and the transaction is finished with a STOP from the master.

Reading from the DS75—When reading from the DS75, if the pointer was already pointed to the desired register during a previous transaction, the read can be performed immediately without changing the pointer setting. In this case the master sends a START followed by an address byte containing the DS75 bus address. The R/W bit must be a 1, which tells the DS75 that a read is being performed. After the DS75 sends an ACK in response to the address byte, the DS75 will begin transmitting the requested data on the next clock cycle. When reading from the configuration register, the DS75 will transmit one byte of data, after which the master must respond with a NACK followed by a STOP (see Figure 9c). For two-byte reads (i.e., from the Temperature, T_{OS} or T_{HYST} register), the DS75 will transmit two bytes of data, and the master must respond to the first data byte with an ACK and to the second byte with a NACK followed by a STOP (see Figure 9d). If only the most significant byte of data is needed, the master can issue a NACK followed by a STOP after reading the first data byte in which case the transaction will be the same as for a read from the configuration register.

If the pointer is not already pointing to the desired register, the pointer must first be updated as shown in Figure 9e, which shows a pointer update followed by a single-byte read. The value of the R/W bit in the initial address byte is a 0 (“write”) since the master is going to write a pointer byte to the DS75. After the DS75 to the address byte with an ACK, the master sends a pointer byte that corresponds to the desired register. The master must then perform a repeated start followed by a standard one or two byte read sequence (with R/W =1) as described in the previous paragraph.

Figure 9. 2-WIRE INTERFACE TIMING

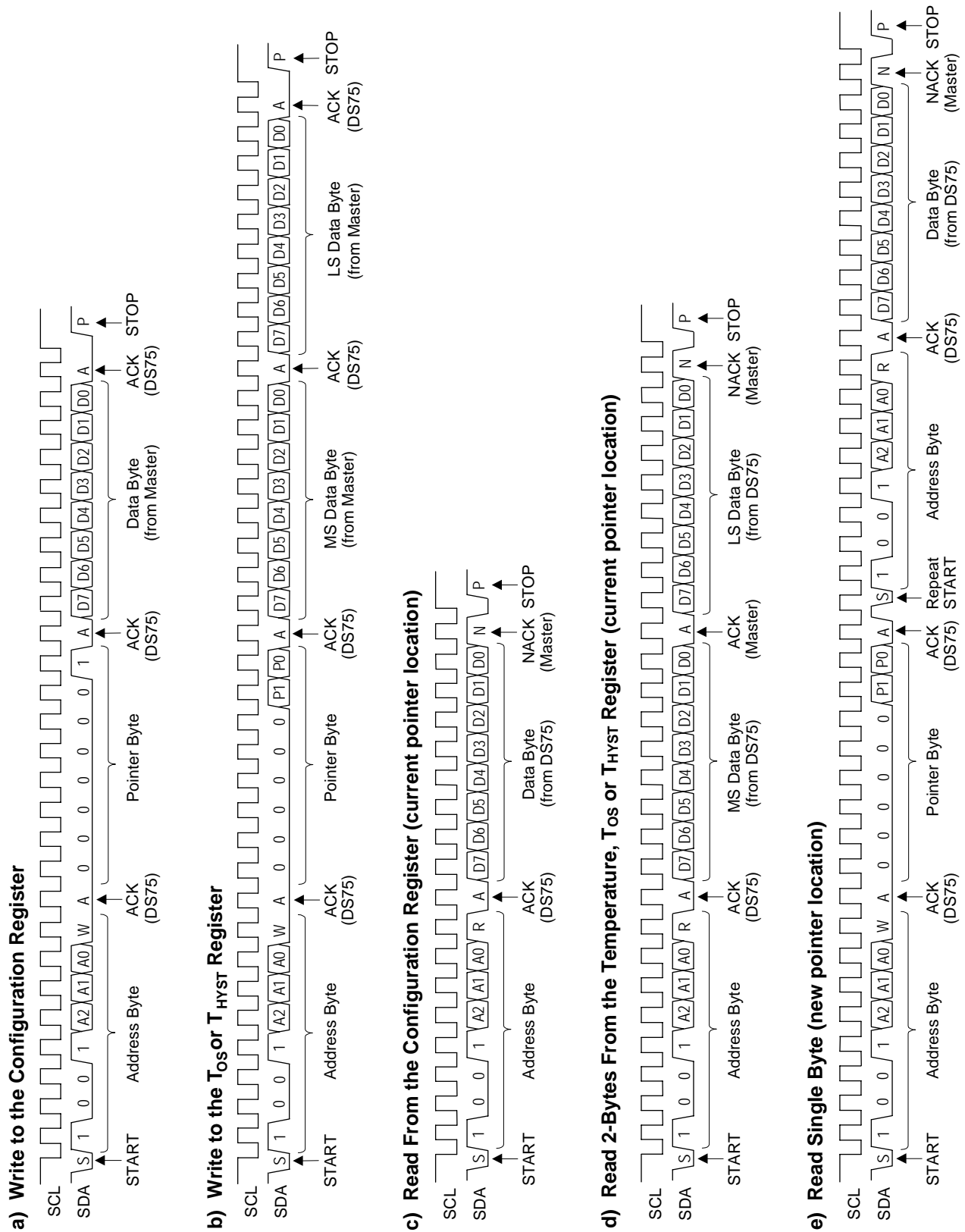

REVISION HISTORY

REVISION DATE	DESCRIPTION	PAGES CHANGED
022108	Deleted all references to flip-chip package. Added registered trademark symbol to μ MAX.	1, 2