

Other Views

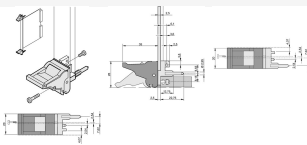

Schroff

Inserter/extractor handle, type IEL, grey, bottom (Rear I/O 6 U top)

Catalog Number: 20817-620

- in accordance with IEEE 1101.10 and IEC 60297-3-102
- with locking
- suitable for insertion and extraction forces up to 700 N (per pair)
- suitable for fitting of microswitches
- block die-cast zinc, nickel plated
- with integrated alignment pin for perforated strip
- codable to IEEE 1101.10 and IEC 60297-3-103
- lever/key UL 94 V-0
- slotted Pozidrive collar screw, M2.5 x 12.3, St, nickel-plated
- panhead screw with Torx, M2.5 x 7, St, nickel-plated



Description

Specification:

- IEC 60297-3-103
- IEEE 1101.10
- IEC 60297-3-102

Handle:

IEL

Type:

Individual Components

Standard:

- CompactPCI
- VME64x

Individual Component Type:

Handle

Product family:

Plug-in units

Delivery Includes:

assembled

Delivery Comprises:

Item	Quantity	Description
1	1	Zn die-cast with integrated alignment pin for perforated strip and IEEE 1101.10 guide rail
2	1	Lever, plastic PC, UL 94 V-0
3	1	Key, plastic PC, UL 94 V-0
4	1	Pozidrive collar screw, M2.5 x 12.3, St, nickel-plated
5	1	Pan head screw with Torx, M2.5 x 7, St, nickel-plated

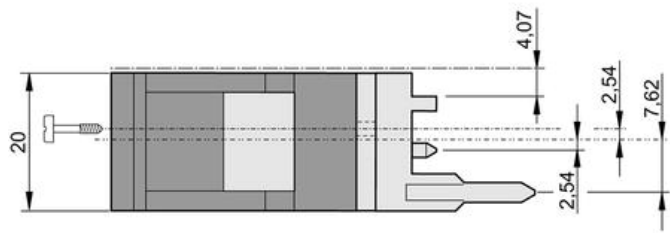
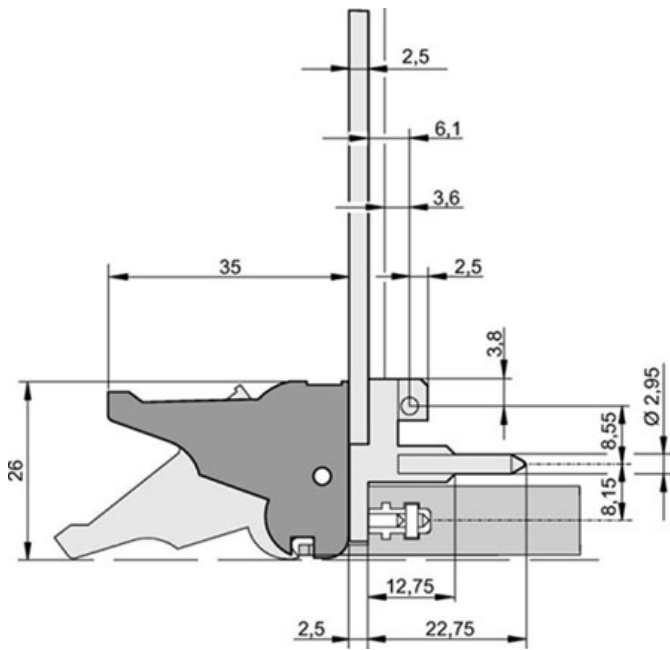

Bottom handle

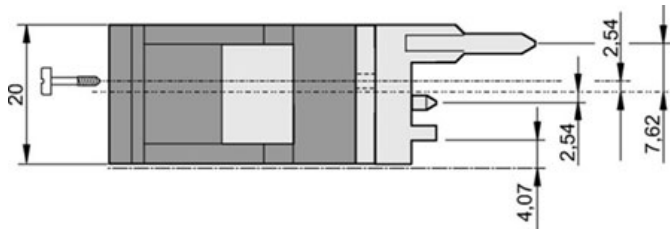



















Upper handle

Technical Data

Catalog Number	20817-620
Qty	PU 10 pieces
Configuration	3 U Bottom Front / 6 U Top Rear I/O / 6 U Bottom Front
Material	Plastic Lever, die-cast zinc base, UL 94 V-0
Finish	Lever: light grey, RAL 7035; Key: black, RAL 9005

Accessories

Item		
	Front panel (3 U 11 HP), U profile, EMC shielding textile gasket, for IEL/IET/Trapeziform Type 2 handle	20848-228
	Front panel (3 U 9 HP), U profile, EMC shielding textile gasket, for IEL/IET/Trapeziform Type 2 handle	20848-227
	Front panel (3 U 16 HP), U profile, EMC shielding textile gasket, for IEL/IET/Trapeziform Type 2 handle	20848-232
	Front panel (3 U 14 HP), U profile, EMC shielding textile gasket, for IEL/IET/Trapeziform Type 2 handle	20848-230
	Front panel (3 U 5 HP), U profile, EMC shielding textile gasket, for IEL/IET/Trapeziform Type 2 handle	30848-300
	Front panel (3 U 7 HP), U profile, EMC shielding textile gasket, for IEL/IET/Trapeziform Type 2 handle	30848-301
	Front panel (3U 4HP), U profile, EMC shielding textile gasket, for IEL/IET/Trapeziform Type 2 handle, 1pcs (SPQ 5)	30848-312
	Front panel (3U 4HP), U profile, EMC shielding textile gasket, for IEL/IET/Trapeziform Type 2 handle, 1pcs (SPQ 5)	30848-313
	Front panel (3U 4HP), U profile, EMC shielding textile gasket, for IEL/IET/Trapeziform Type 2 handle, 1pcs (SPQ 5)	30848-314
	Front panel (3U 4HP), U profile, EMC shielding textile gasket, for IEL/IET/Trapeziform Type 2 handle, 1pcs (SPQ 5)	30848-315
	Front panel (3U 4HP), U profile, EMC shielding textile gasket, for IEL/IET/Trapeziform Type 2 handle, 1pcs (SPQ 5)	30848-316
	Front panel (3U 4HP), U profile, EMC shielding textile gasket, for IEL/IET/Trapeziform Type 2 handle, 1pcs (SPQ 5)	30848-327
	Front panel (3U 4HP), U profile, EMC shielding textile gasket, for IEL/IET/Trapeziform Type 2 handle, 1pcs (SPQ 5)	30848-328
	Front panel (3U 4HP), U profile, EMC shielding textile gasket, for IEL/IET/Trapeziform Type 2 handle, 1pcs (SPQ 5)	30848-329
	Front panel (3U 4HP), U profile, EMC shielding textile gasket, for IEL/IET/Trapeziform Type 2 handle, 1pcs (SPQ 5)	30848-330
	Front panel (3U 4HP), U profile, EMC shielding textile gasket, for IEL/IET/Trapeziform Type 2 handle, 1pcs (SPQ 5)	30848-331
	Front panel (3U 4HP), U profile, EMC shielding textile gasket, for IEL/IET/Trapeziform Type 2 handle, 1pcs (SPQ 5)	30848-333

	<p>Front panel (3U 4HP), U profile, EMC shielding textile gasket, for IEL/IET/Trapeziform Type 2 handle, 1pcs (SPQ 5)</p>	<p>30848-335</p>	
	<p>Keying/coding, grey, for IEL/ IET handle, PU 100 pcs</p>	<p>20817-501</p>	
	<p>Microswitch for IEL/IET handle, PU 10 pcs</p>	<p>20817-606</p>	
	<p>Label strips for IEL/IET handle, white, sheet with 210pcs (19x9,5), PU 1 pcs</p>	<p>60817-340</p>	
	<p>Label strips for IEL handle, white, sheet with 320pcs (19x4,8), PU 1 pcs</p>	<p>60817-341</p>	