

Clogging Indicators



Clogging indicators are devices that check the life time of the filter elements. They measure the pressure drop through the filter element directly connected to the filter housing.

These devices trip when the clogging of the filter element causes a pressure drop increasing across the filter element.

Filter elements are efficient only if their Dirt Holding Capacity is fully exploited. This is achieved by using filter housings equipped with clogging indicators. The indicator is set to alarm before the element becomes fully clogged.

MP Filtri can supply indicators of the following designs:

- Vacuum switches and gauges
- Pressure switches and gauges
- Differential pressure indicators

These type of devices can be provided with a visual, electrical or both signals. The electronic differential pressure clogging indicator is also available. It provides both analogical 4-20 mA output and digital warning (75% of clogging) and alarm (clogging) outputs.

Index

	Page
VACUUM INDICATORS	2
BAROMETRIC INDICATORS	4
DIFFERENTIAL INDICATORS	8
STAINLESS STEEL DIFFERENTIAL INDICATOR	16
QUICK REFERENCE GUIDE	20

Clogging indicators



Suitable indicator types

VACUUM INDICATORS

Vacuum indicators are used on the Suction line to check the efficiency of the filter element.

They measure the pressure downstream of the filter element.

Standard items are produced with R 1/4" EN 10226 connection.

Available products with R 1/8" EN 10226 to be fitted on MPS series.

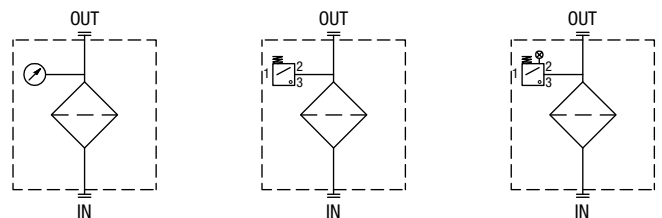

BAROMETRIC INDICATORS

Pressure indicators are used on the Return line to check the efficiency of the filter element.

They measure the pressure upstream of the filter element.

Standard items are produced with R 1/8" EN 10226 connection.

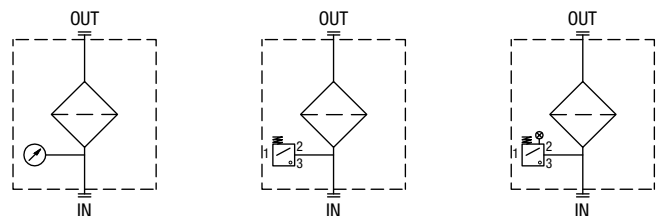

DIFFERENTIAL INDICATORS

Differential indicators are used on the Pressure line to check the efficiency of the filter element.

They measure the pressure upstream and downstream of the filter element (differential pressure).

Standard items are produced with special connection G 1/2" size.

Also available in Stainless Steel models.

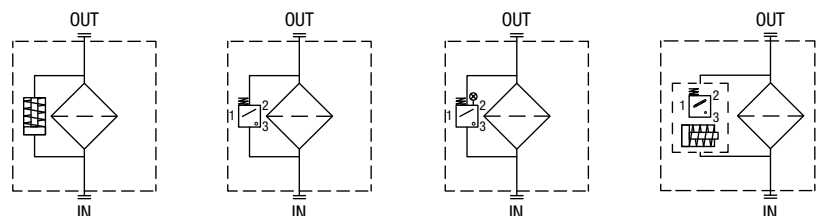

VACUUM INDICATORS

Dimensions

VE*50	
Electrical Vacuum Indicator	
R	Ordering code
EN 10226 - R1/4"	VE A 21 A A 50 P01
EN 10226 - R1/8"	VE B 21 A A 50 P01

A/F 27
Max tightening torque: 25 N·m

Hydraulic symbol

Electrical symbol

Materials

- Body: Brass
- Base: Black Nylon
- Contacts: Silver
- Seal: NBR

Technical data

- Vacuum setting: -0.21 bar ±10%
- Max working pressure: 10 bar
- Proof pressure: 15 bar
- Working temperature: From -25 °C to +80 °C
- Compatibility with fluids: Mineral oils, Synthetic fluids
HFA, HFB, HFC according to ISO 2943
- Degree of protection: IP65 according to EN 60529

Electrical data

- Electrical connection: EN 175301-803
- Resistive load: 5 A / 14 Vdc
4 A / 30 Vdc
5 A / 125 Vac
4 A / 250 Vac

- Available Atex product: II 1GD Ex ia IIC Tx Ex ia IIIC Tx °C X
- CE certification

VL*51 - VL*52 - VL*53	
Electrical/Visual Vacuum Indicator	
R	Ordering code
EN 10226 - R1/4"	VL A 21 A A xx P01
EN 10226 - R1/8"	VL B 21 A A xx P01

A/F 27
Max tightening torque: 25 N·m

Hydraulic symbol

Electrical symbol

Materials

- Body: Brass
- Base: Transparent Nylon
- Contacts: Brass - Nylon
- Seal: NBR

Technical data

- Vacuum setting: -0.21 bar ±10%
- Max working pressure: 10 bar
- Proof pressure: 15 bar
- Working temperature: From -25 °C to +80 °C
- Compatibility with fluids: Mineral oils, Synthetic fluids
HFA, HFB, HFC according to ISO 2943
- Degree of protection: IP65 according to EN 60529

Electrical data

- Electrical connection: EN 175301-803
- Type: 51 52 53
- Lamps: 24 Vdc 110 Vdc 230 Vac
- Resistive load: 1 A / 24 Vdc 1 A / 110 Vdc 1 A / 230 Vac

VL*71	
Electrical/Visual Vacuum Indicator	
Connections	Indicator code
EN 10226 - R1/4"	VL A 21 A A 71 P01
EN 10226 - R1/8"	VL B 21 A A 71 P01

A/F 27
Max tightening torque: 25 N·m

Hydraulic symbol

Electrical symbol

Materials

- Body: Brass
- Base: Black Nylon
- Contacts: Silver
- Seal: NBR

Technical data

- Vacuum setting: -0.21 bar ±10%
- Max working pressure: 10 bar
- Proof pressure: 15 bar
- Working temperature: From -25 °C to +80 °C
- Compatibility with fluids: Mineral oils, Synthetic fluids
HFA, HFB, HFC according to ISO 2943
- Degree of protection: IP65 according to EN 60529

Electrical data

- Electrical connection: IEC 61076-2-101 D (M12)
- Lamps: 24 Vdc
- Resistive load: 0.4 A / 24 Vdc

VVA - VVB	
Axial Vacuum Gauge	
R	Ordering code
EN 10226 - R1/4"	VVA 16 P01
EN 10226 - R1/8"	VVB 16 P01

Hydraulic symbol

Dial scale

[cmHg]	[bar]
-12	-0.16
-18	-0.24
-76	-1.01

Materials

- Case: Painted Steel
- Window: Transparent plastic
- Dial: Painted Steel
- Pointer: Painted Aluminium
- Pressure connection: Brass
- Pressure element: Bourdon tube Cu-alloy soft soldered

Technical data

- Max working pressure: Static: 7 bar
Fluctuating: 6 bar
Short time: 10 bar
- Working temperature: From -40 °C to +60 °C
- Compatibility with fluids: Mineral oils, Synthetic fluids
HFA, HFB, HFC according to ISO 2943
- Accuracy: Class 2.5 according to EN 13190
- Degree of protection: IP31 according to EN 60529

VVR - VVS		
Radial Vacuum Gauge		
R	A/F	Ordering code
EN 10226 - R1/4"	14	VVR 16 P01
EN 10226 - R1/8"	11	VVS 16 P01

Hydraulic symbol

Dial scale

[cmHg]	[bar]
-12	-0.16
-18	-0.24
-76	-1.01

Materials

- Case: Painted Steel
- Window: Transparent plastic
- Dial: Painted Steel
- Pointer: Painted Aluminium
- Pressure connection: Brass
- Pressure element: Bourdon tube Cu-alloy soft soldered

Technical data

- Max working pressure: Static: 7 bar
Fluctuating: 6 bar
Short time: 10 bar
- Working temperature: From -40 °C to +60 °C
- Compatibility with fluids: Mineral oils, Synthetic fluids
HFA, HFB, HFC according to ISO 2943
- Accuracy: Class 2.5 according to EN 13190
- Degree of protection: IP31 according to EN 60529

Designation & Ordering code

VACUUM INDICATORS							
Series	Configuration example 1:	VE	A	21	A	A	50 P01
VE Electrical vacuum indicator	Configuration example 2:	VL	B	21	A	A	71 P01
VL Electrical/Visual vacuum indicator	Configuration example 3:	VV	R	16			P01
VV Vacuum gauge							
Type VE - VL	Type VV						
A Connection EN 10226 - R1/4"	A Axial connection EN 10226 - R1/4"						
B Connection EN 10226 - R1/8"	B Axial connection EN 10226 - R1/8"						
	R Radial connection EN 10226 - R1/4"						
	S Radial connection EN 10226 - R1/8"						
Vacuum setting		VE	VL	VV			
16 -0.16 bar				•			
21 -0.21 bar		•	•				
Seals		VE	VL				
A NBR		•	•				
Thermostat		VE	VL				
A Without		•	•				
Electrical connections		VE	VL				
50 Connection EN 175301-803		•					
51 Connection EN 175301-803, transparent base with lamps 24 Vdc					•		
52 Connection EN 175301-803, transparent base with lamps 110 Vdc					•		
53 Connection EN 175301-803, transparent base with lamps 230 Vdc					•		
71 Connection IEC 61076-2-101 D (M12), black base with lamps 24 Vdc					•		
	Option						
	P01 MP Filtri standard						
	Pxx Customized						

BAROMETRIC INDICATORS

Dimensions

BEA*50	
Electrical Pressure Indicator	
Settings	Ordering code
1.5 bar $\pm 10\%$	BE A 15 H A 50 P01
2.0 bar $\pm 10\%$	BE A 20 H A 50 P01
<p>Hydraulic symbol</p>	
<p>Electrical symbol</p>	
<p>Materials</p> <ul style="list-style-type: none"> - Body: Brass - Base: Black Nylon - Contacts: Silver - Seal: HNBR 	
<p>Technical data</p> <ul style="list-style-type: none"> - Max working pressure: 40 bar - Proof pressure: 60 bar - Working temperature: From -25 °C to +80 °C - Compatibility with fluids: Mineral oils, Synthetic fluids HFA, HFB, HFC according to ISO 2943 - Degree of protection: IP65 according to EN 60529 	
<p>Electrical data</p> <ul style="list-style-type: none"> - Electrical connection: EN 175301-803 - Resistive load: 5 A / 14 Vdc 4 A / 30 Vdc 5 A / 125 Vac 4 A / 250 Vac <p>- Available Atex product: II 1GD Ex ia IIC Tx Ex ia IIIC Tx °C X </p> <p>- CE certification</p>	

BEM*41	
Electrical Pressure Indicator	
Settings	Ordering code
1.5 bar $\pm 10\%$	BE M 15 H A 41 P01
2.0 bar $\pm 10\%$	BE M 20 H A 41 P01
<p>Hydraulic symbol</p>	
<p>Electrical symbol</p>	
<p>Materials</p> <ul style="list-style-type: none"> - Body: Brass - Base: Black Nylon - Contacts: Silver - Seal: HNBR 	
<p>Technical data</p> <ul style="list-style-type: none"> - Max working pressure: 40 bar - Proof pressure: 60 bar - Working temperature: From -25 °C to +80 °C - Compatibility with fluids: Mineral oils, Synthetic fluids HFA, HFB, HFC according to ISO 2943 - Degree of protection: IP67 according to EN 60529 	
<p>Electrical data</p> <ul style="list-style-type: none"> - Electrical connection: Four-core cable - Resistive load: 5 A / 14 Vdc 4 A / 30 Vdc 5 A / 125 Vac 4 A / 250 Vac <p>- CE certification On request this indicator can be provided with main connectors in use for wirings.</p>	

BET*10	
Electrical Pressure Indicator	
Settings	Ordering code
2.0 bar $\pm 10\%$	BET 20 H F 10 P01
2.5 bar $\pm 10\%$	BET 25 H F 10 P01
<p>Hydraulic symbol</p>	
<p>Electrical symbol</p>	
<p>Materials</p> <ul style="list-style-type: none"> - Body: Brass - Base: Black Nylon - Contacts: Silver - Seal: HNBR 	
<p>Technical data</p> <ul style="list-style-type: none"> - Max working pressure: 10 bar - Proof pressure: 15 bar - Working temperature: From -25 °C to +100 °C - Compatibility with fluids: Mineral oils, Synthetic fluids HFA, HFB, HFC according to ISO 2943 - Degree of protection: IP65 according to EN 60529 	
<p>Electrical data</p> <ul style="list-style-type: none"> - Electrical connection: AMP Superseal series 1.5 - Resistive load: 0.5 A / 48 Vdc - Thermostat condition: Open up to 30 °C <p>- CE certification</p>	

BET*30	
Electrical Pressure Indicator	
Settings	Ordering code
2.0 bar $\pm 10\%$	BET 20 H F 30 P01
2.5 bar $\pm 10\%$	BET 25 H F 30 P01

A/F 27
Max tightening torque: 25 N·m

EN 10226 - R1/8"

Hydraulic symbol

Electrical symbol

Thermal lockout

Materials

- Body: Brass
- Base: Black Nylon
- Contacts: Silver
- Seal: HNBR

Technical data

- Max working pressure: 10 bar
- Proof pressure: 15 bar
- Working temperature: From -25 °C to +100 °C
- Compatibility with fluids: Mineral oils, Synthetic fluids HFA, HFB, HFC according to ISO 2943
- Degree of protection: IP65 according to EN 60529

Electrical data

- Electrical connection: Deutsch DT-04-2-P
- Resistive load: 0.5 A / 48 Vdc
- Thermostat condition: Open up to 30 °C
- CE certification

BET*50	
Electrical Pressure Indicator	
Settings	Ordering code
2.0 bar $\pm 10\%$	BET 20 H F 50 P01
2.5 bar $\pm 10\%$	BET 25 H F 50 P01

A/F 27
Max tightening torque: 25 N·m

EN 10226 - R1/8"

Hydraulic symbol

Electrical symbol

Thermal lockout

Not connected

Materials

- Body: Brass
- Base: Black Nylon
- Contacts: Silver
- Seal: HNBR

Technical data

- Max working pressure: 10 bar
- Proof pressure: 15 bar
- Working temperature: From -25 °C to +100 °C
- Compatibility with fluids: Mineral oils, Synthetic fluids HFA, HFB, HFC according to ISO 2943
- Degree of protection: IP65 according to EN 60529

Electrical data

- Electrical connection: EN 175301-803
- Resistive load: 0.5 A / 48 Vdc
- Thermostat condition: Open up to 30 °C
- CE certification

BL*51 - BL*52 - BL*53	
Electrical/Visual Pressure Indicator	
Settings	Ordering code
1.5 bar $\pm 10\%$	BL A 15 H A xx P01
2.0 bar $\pm 10\%$	BL A 20 H A xx P01

A/F 27
Max tightening torque: 25 N·m

EN 10226 - R1/8"

Hydraulic symbol

Electrical symbol

GREEN LAMP

RED LAMP

Materials

- Body: Brass
- Base: Transparent Nylon
- Contacts: Silver
- Seal: HNBR

Technical data

- Max working pressure: 40 bar
- Proof pressure: 60 bar
- Working temperature: From -25 °C to +80 °C
- Compatibility with fluids: Mineral oils, Synthetic fluids HFA, HFB, HFC according to ISO 2943
- Degree of protection: IP65 according to EN 60529

Electrical data

- Electrical connection: EN 175301-803
- Type: 51 52 53
- Lamps: 24 Vdc 110 Vdc 230 Vac
- Resistive load: 1 A / 24 Vdc 1 A / 110 Vdc 1 A / 230 Vac

BAROMETRIC INDICATORS

Dimensions

BL*71	
Electrical/Visual Pressure Indicator	
Settings	Ordering code
1.5 bar $\pm 10\%$	BL A 15 HA 71 P01
2.0 bar $\pm 10\%$	BL A 20 HA 71 P01
<p>Hydraulic symbol</p>	
<p>Electrical symbol</p>	
<p>Materials</p> <ul style="list-style-type: none"> - Body: Brass - Base: Black Nylon - Contacts: Silver - Seal: HNBR 	
<p>Technical data</p> <ul style="list-style-type: none"> - Max working pressure: 40 bar - Proof pressure: 60 bar - Working temperature: From -25 °C to +80 °C - Compatibility with fluids: Mineral oils, Synthetic fluids HFA, HFB, HFC according to ISO 2943 - Degree of protection: IP65 according to EN 60529 	
<p>Electrical data</p> <ul style="list-style-type: none"> - Electrical connection: IEC 61076-2-101 D (M12) - Lamps: 24 Vdc - Resistive load: 0.4 A / 24 Vdc 	

BVA	
Axial Pressure Gauge	
Settings	Ordering code
1.4 bar $\pm 10\%$	BVA 14 P01
2.5 bar $\pm 10\%$	BVA 25 P01
<p>Hydraulic symbol</p>	
<p>Dial scale</p> <p>BVA 14 P01</p> <p>BVA 25 P01</p>	
<p>Materials</p> <ul style="list-style-type: none"> - Case: Painted Steel - Window: Transparent plastic - Dial: Painted Steel - Pointer: Painted Aluminium - Pressure connection: Brass - Pressure element: Bourdon tube Cu-alloy soft soldered 	
<p>Technical data</p> <ul style="list-style-type: none"> - Max working pressure: Static: 7 bar Fluctuating: 6 bar Short time: 10 bar - Working temperature: From -40 °C to +60 °C - Compatibility with fluids: Mineral oils, Synthetic fluids HFA, HFB, HFC according to ISO 2943 - Accuracy: Class 2.5 according to EN 13190 - Degree of protection: IP31 according to EN 60529 	

BVR	
Radial Pressure Gauge	
Settings	Ordering code
1.4 bar $\pm 10\%$	BV R 14 P01
2.5 bar $\pm 10\%$	BV R 25 P01
<p>Hydraulic symbol</p>	
<p>Dial scale</p> <p>BV R 14 P01</p> <p>BV R 25 P01</p>	
<p>Materials</p> <ul style="list-style-type: none"> - Case: Painted Steel - Window: Transparent plastic - Dial: Painted Steel - Pointer: Painted Aluminium - Pressure connection: Brass - Pressure element: Bourdon tube Cu-alloy soft soldered 	
<p>Technical data</p> <ul style="list-style-type: none"> - Max working pressure: Static: 7 bar Fluctuating: 6 bar Short time: 10 bar - Working temperature: From -40 °C to +60 °C - Compatibility with fluids: Mineral oils, Synthetic fluids HFA, HFB, HFC according to ISO 2943 - Accuracy: Class 2.5 according to EN 13190 - Degree of protection: IP31 according to EN 60529 	

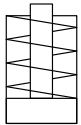
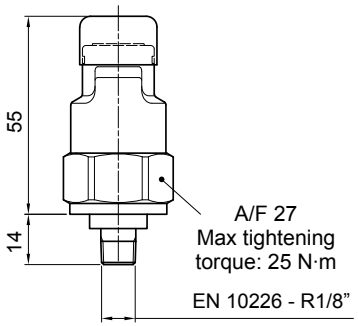
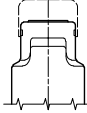
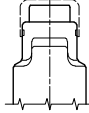
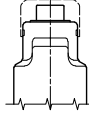
BVP - BVQ		Hydraulic symbol	Materials	
Visual Pressure Indicator				
Setting	Ordering code			
1.5 bar ±10%	BV P 15 H P01 BV Q 15 H P01		Technical data - Reset: BVP - Automatic reset BVQ - Manual reset - Max working pressure: 10 bar - Proof pressure: 15 bar - Working temperature: From -25 °C to +80 °C - Compatibility with fluids: Mineral oils, Synthetic fluids HFA, HFB, HFC according to ISO 2943 - Degree of protection: IP45 according to EN 60529	
2.0 bar ±10%	BV P 20 H P01 BV Q 20 H P01			
		Signals		
		 Absence of pressure (no indicator)	 Presence of pressure (green button rises gradually)	 Clogged filter element (red button risen)

Designation & Ordering code

BAROMETRIC INDICATORS								
Series								
BE Electrical pressure indicator								
BL Electrical/Visual pressure indicator								
BV Visual pressure indicator								
	Configuration example 1:	BE	M	15	H	A	41	P01
	Configuration example 2:	BL	A	20	H	A	71	P01
	Configuration example 3:	BV	P	20	H			P01
	Configuration example 4:	BV	R	14				P01
Type BE - BL		BE	BL					
A Standard type		•	•					
M With wired electrical connection		•						
T With thermal switch		•						
Type BV								
A Axial connection pressure gauge								
P Visual indicator with automatic reset								
Q Visual indicator with manual reset								
R Radial connection pressure gauge								
Pressure setting		BEA-BEM	BET	BLA	BVA-BVR	BVP-BVQ		
14 1.4 bar						•		
15 1.5 bar		•		•				
20 2.0 bar		•	•	•		•		
25 2.5 bar			•		•			
Seals		BEA-BEM	BET	BLA	BVP-BVQ			
H HNBR		•	•	•	•			
Thermostat		BEA-BEM	BET	BLA				
A Without		•		•				
F With			•					
Electrical connections		BEA	BEM	BET	BLA			
10 Connection AMP Superseal series 1.5				•				
30 Connection Deutsch DT-04-2-P				•				
41 Connection via four-core cable			•					
50 Connection EN 175301-803			•	•				
51 Connection EN 175301-803, transparent base with lamps 24 Vdc						•		
52 Connection EN 175301-803, transparent base with lamps 110 Vdc						•		
53 Connection EN 175301-803, transparent base with lamps 230 Vdc						•		
71 Connection IEC 61076-2-101 D (M12), black base with lamps 24 Vdc						•		
	Option							
	P01 MP Filtri standard							
	Pxx Customized							

DIFFERENTIAL INDICATORS

Dimensions

DEA*50	
Electrical Differential Indicator	
Settings	Ordering code
1.2 bar ±10%	DE A 12 x A 50 P01
2.0 bar ±10%	DE A 20 x A 50 P01
5.0 bar ±10%	DE A 50 x A 50 P01
7.0 bar ±10%	DE A 70 x A 50 P01
9.5 bar ±10%	DE A 95 x A 50 P01

Hydraulic symbol

Electrical symbol

Materials

- Body: Brass
- Base: Black Nylon
- Contacts: Silver
- Seal: HNBR - FPM

Technical data

- Max working pressure: 420 bar
- Proof pressure: 630 bar
- Burst pressure: 1260 bar
- Working temperature: From -25 °C to +110 °C
- Compatibility with fluids: Mineral oils, Synthetic fluids
HFA, HFB, HFC according to ISO 2943
- Degree protection: IP66 according to EN 60529
IP69K according to ISO 20653

Electrical data

- Electrical connection: EN 175301-803
- Resistive load: 0.2 A / 115 Vdc

DEH*48	
Hazardous Area Electronic Differential Indicator	
Settings	Ordering code
5.0 bar ±10%	DE H 50 x A 48 P01
7.0 bar ±10%	DE H 70 x A 48 P01

Connection diagram

Certification / Approvals:
ATEX, IECEx, TRCU, INMETRO

Certification included as standard

Materials

- Body: AISI 316 Stainless steel
- Contacts: Rhodium (tungsten optional)
- Seal: MFQ - FPM

Protection class Ex ia IIC T4/T6: Intrinsically safe

Temperature class T4 (135 °C) and T6 (85 °C)

Technical data

- Max working pressure: 420 bar
- Working temperature: From -60 °C to +125 °C
- Connection type: M20 x 1.5 - 3 core polyrad cable supplied with 5 meters
- Contact type: SPCO/SPDT (Hermetically sealed - volt free contacts)
- Compatibility with fluids: Mineral oils, Synthetic fluids
HFA, HFB, HFC according to ISO 2943
- Degree of protection: IP 66/67/68 according to EN 60529

Electrical data

- Current Ratings: 24v DC 830mA - 110v AC 180mA
- Electrical Ratings: Ui 30V - Li 250mA - Pi 1.3W

DEH*49	
Hazardous Area Electronic Differential Indicator	
Settings	Ordering code
5.0 bar ±10%	DE H 50 x A 49 P01
7.0 bar ±10%	DE H 70 x A 49 P01

Connection diagram

Certification / Approvals:
ATEX, IECEx, TRCU, INMETRO, UL/CSA Class I Division 1 Groups A-D, UL/CSA Class II Division 1 Groups E-G

Certification included as standard

Materials

- Body: AISI 316 Stainless steel
- Contacts: Rhodium (tungsten optional)
- Seal: MFQ - FPM

Protection class Ex d IIC T4/T6: Flameproof

Temperature class T4 (135 °C) and T6 (85 °C)

Technical data

- Max working pressure: 420 bar
- Working temperature: From -60 °C to +120 °C : ATEX, IECEx, TRCU, INMETRO
From -60 °C to +105 °C : UL/CSA
- Connection type: 1/2" NPT - 3 core polyrad cable supplied with 5 meters
- Contact type: SPCO/SPDT (Hermetically sealed - volt free contacts)
- Compatibility with fluids: Mineral oils, Synthetic fluids
HFA, HFB, HFC according to ISO 2943
- Degree of protection: IP 66/67/68 according to EN 60529

Electrical data

- Current Ratings: 24v DC 830mA - 110v AC 180mA
- Electrical Ratings: Supply Voltage | 24 VDC | 110 VAC |
Max switching current | 830mA | 180mA |
Max voltage | 150 V AC/DC |
Power watts | 20 W VA |

DEH*70		Connection diagram	Materials	
Hazardous Area Electronic Differential Indicator				
Settings	Ordering code	Protection class		
5.0 bar ±10%	DE H 50 x A 70 P01	EX ia IIC T6: Intrinsically safe		
7.0 bar ±10%	DE H 70 x A 70 P01		Temperature class	
			Technical data	
			- Max working pressure: 420 bar - Working temperature: From -20 °C to +80 °C - Connection type: 4 pole male M12 connector - plastic - Contact type: SPCO/SPDT (Hermetically sealed - volt free contacts) - Compatibility with fluids: Mineral oils, Synthetic fluids - Degree of protection: IP 66/67 according to EN 60529	
		- Certification / Approvals: ATEX, IECEx, TRCU, INMETRO - Certification included as standard	Electrical data	
			- Current Ratings: 24v DC 830mA - 110v AC 180mA - Electrical Ratings: Ui 30V - Li 250mA - Pi 1.3W	

DEM*10		Hydraulic symbol	Materials	
Electrical Differential Indicator				
Settings	Ordering code	Technical data		
1.2 bar ±10%	DE M 12 x x 10 P01	- Max working pressure: 420 bar - Proof pressure: 630 bar - Burst pressure: 1260 bar - Working temperature: From -25 °C to +110 °C - Compatibility with fluids: Mineral oils, Synthetic fluids		
2.0 bar ±10%	DE M 20 x x 10 P01		- Degree protection:	
5.0 bar ±10%	DE M 50 x x 10 P01		Electrical data	
7.0 bar ±10%	DE M 70 x x 10 P01		- Electrical connection: AMP Superseal series 1.5 - Resistive load: 0.2 A / 115 Vdc - Switching type: Normally open contacts (NC on request) - Thermal lockout: Normally open up to 30 °C (option "F")	
9.5 bar ±10%	DE M 95 x x 10 P01			

DEM*20		Hydraulic symbol	Materials	
Electrical Differential Indicator				
Settings	Ordering code	Technical data		
1.2 bar ±10%	DE M 12 x x 20 P01	- Max working pressure: 420 bar - Proof pressure: 630 bar - Burst pressure: 1260 bar - Working temperature: From -25 °C to +110 °C - Compatibility with fluids: Mineral oils, Synthetic fluids		
2.0 bar ±10%	DE M 20 x x 20 P01		- Degree protection:	
5.0 bar ±10%	DE M 50 x x 20 P01		Electrical data	
7.0 bar ±10%	DE M 70 x x 20 P01		- Electrical connection: AMP Time junior - Resistive load: 0.2 A / 115 Vdc - Switching type: Normally open contacts (NC on request) - Thermal lockout: Normally open up to 30 °C (option "F")	
9.5 bar ±10%	DE M 95 x x 20 P01			

DIFFERENTIAL INDICATORS

Dimensions

DEM*30	
Electrical Differential Indicator	
Settings	Ordering code
1.2 bar ±10%	DE M 12 x x 30 P01
2.0 bar ±10%	DE M 20 x x 30 P01
5.0 bar ±10%	DE M 50 x x 30 P01
7.0 bar ±10%	DE M 70 x x 30 P01
9.5 bar ±10%	DE M 95 x x 30 P01

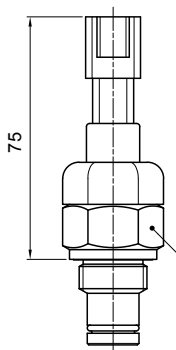

A/F 28
Max tightening torque: 65 N·m

Hydraulic symbol

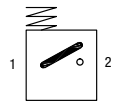

Electrical symbol

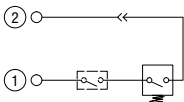

Materials

- Body: Brass
- Base: Black Nylon
- Contacts: Silver
- Seal: HNBR - FPM

Technical data

- Max working pressure: 420 bar
- Proof pressure: 630 bar
- Burst pressure: 1260 bar
- Working temperature: From -25 °C to +110 °C
- Compatibility with fluids: Mineral oils, Synthetic fluids
HFA, HFB, HFC according to ISO 2943
- Degree protection: IP66 according to EN 60529

Electrical data

- Electrical connection: Deutsch DT-04-2-P
- Resistive load: 0.2 A / 115 Vdc
- Switching type: Normally open contacts (NC on request)
- Thermal lockout: Normally open up to 30 °C (option "F")

DEM*35	
Electrical Differential Indicator	
Settings	Ordering code
1.2 bar ±10%	DE M 12 x x 35 P01
2.0 bar ±10%	DE M 20 x x 35 P01
5.0 bar ±10%	DE M 50 x x 35 P01
7.0 bar ±10%	DE M 70 x x 35 P01
9.5 bar ±10%	DE M 95 x x 35 P01

A/F 28
Max tightening torque: 65 N·m

flexible cable: 240 to "A"

Hydraulic symbol

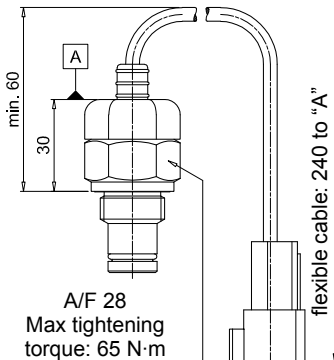

Electrical symbol

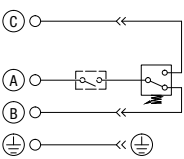

Materials

- Body: Brass
- Base: Black Nylon
- Contacts: Silver
- Seal: HNBR - FPM

Technical data

- Max working pressure: 420 bar
- Proof pressure: 630 bar
- Burst pressure: 1260 bar
- Working temperature: From -25 °C to +110 °C
- Compatibility with fluids: Mineral oils, Synthetic fluids
HFA, HFB, HFC according to ISO 2943
- Degree protection: IP66 according to EN 60529

Electrical data

- Electrical connection: Deutsch DT-04-3-P
- Resistive load: 0.2 A / 115 Vdc
- Switching type: SPDT contact
- Thermal lockout: Normally open up to 30 °C (option "F")

DES*10	
Electrical Differential Indicator	
Settings	Ordering code
2.5 bar ±10%	DE S 25 HA 10 P01
4.0 bar ±10%	DE S 40 HA 10 P01

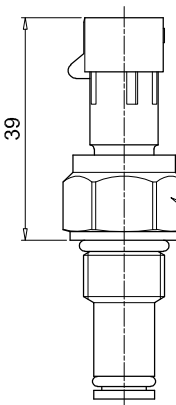

A/F 19
Max tightening torque: 20 N·m

Hydraulic symbol

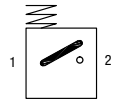

Electrical symbol

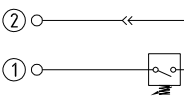

Materials

- Body: Brass
- Internal parts: Brass - Nylon
- Contacts: Silver
- Seal: HNBR

Technical data

- Max working pressure: 16 bar
- Proof pressure: 24 bar
- Burst pressure: 48 bar
- Working temperature: From -25 °C to +110 °C
- Compatibility with fluids: Mineral oils, Synthetic fluids
HFA, HFB, HFC according to ISO 2943
- Degree protection: IP67 according to EN 60529

Electrical data

- Electrical connection: AMP Superseal series 1.5
- Resistive load: 0.2 A / 24 Vdc
- Switching type: Normally open contacts (NC on request)

DIFFERENTIAL INDICATORS

Dimensions

DLA*71	
Electrical/Visual Differential Indicator	
Settings	Ordering code
1.2 bar ±10%	DL A 12 x A 71 P01
2.0 bar ±10%	DL A 20 x A 71 P01
5.0 bar ±10%	DL A 50 x A 71 P01
7.0 bar ±10%	DL A 70 x A 71 P01
9.5 bar ±10%	DL A 95 x A 71 P01

A/F 30
Max tightening torque: 65 N·m

Hydraulic symbol

Electrical symbol

Materials

- Body: Brass
- Base: Black Nylon
- Contacts: Silver
- Seal: HNBR - FPM

Technical data

- Max working pressure: 420 bar
- Proof pressure: 630 bar
- Burst pressure: 1260 bar
- Working temperature: From -25 °C to +110 °C
- Compatibility with fluids: Mineral oils, Synthetic fluids
HFA, HFB, HFC according to ISO 2943
- Degree protection: IP65 according to EN 60529
IP69K according to ISO 20653

Electrical data

- Electrical connection: IEC 61076-2-101 D (M12)
- Lamps: 24 Vdc
- Resistive load: 0.4 A / 24 Vdc

DLE*A50	
Electrical/Visual Differential Indicator	
Settings	Ordering code
1.2 bar ±10%	DL E 12 x A 50 P01
2.0 bar ±10%	DL E 20 x A 50 P01
5.0 bar ±10%	DL E 50 x A 50 P01
7.0 bar ±10%	DL E 70 x A 50 P01
9.5 bar ±10%	DL E 95 x A 50 P01

59

58

A/F 32
Max tightening torque: 95 N·m

Hydraulic symbol

Electrical symbol

Materials

- Body: Brass
- Base: Black Nylon
- Contacts: Silver
- Seal: HNBR - FPM

Technical data

- Max working pressure: 420 bar
- Proof pressure: 630 bar
- Burst pressure: 1260 bar
- Working temperature: From -25 °C to +110 °C
- Compatibility with fluids: Mineral oils, Synthetic fluids
HFA, HFB, HFC according to ISO 2943
- Degree protection: IP65 according to EN 60529

Electrical data

- Electrical connections: EN 175301-803
- Resistive load: 5 A / 250 Vac
- Available the connector with lamps

DLE*F50	
Electrical/Visual Differential Indicator	
Settings	Ordering code
1.2 bar ±10%	DL E 12 x F 50 P01
2.0 bar ±10%	DL E 20 x F 50 P01
5.0 bar ±10%	DL E 50 x F 50 P01
7.0 bar ±10%	DL E 70 x F 50 P01
9.5 bar ±10%	DL E 95 x F 50 P01

58

58

A/F 32
Max tightening torque: 95 N·m

Hydraulic symbol

Electrical symbol

Materials

- Body: Brass
- Base: Black Nylon
- Contacts: Silver
- Seal: HNBR - FPM

Technical data

- Max working pressure: 420 bar
- Proof pressure: 630 bar
- Burst pressure: 1260 bar
- Working temperature: From -25 °C to +110 °C
- Compatibility with fluids: Mineral oils, Synthetic fluids
HFA, HFB, HFC according to ISO 2943
- Degree protection: IP65 according to EN 60529

Electrical data

- Electrical connections: EN 175301-803
- Resistive load: 5 A / 250 Vac
- Thermal lockout setting: +30 °C

DTA*70	
Electronic Differential Indicator	
Settings	Ordering code
1.2 bar ±10%	DT A 12 x x 70 P01
2.0 bar ±10%	DT A 20 x x 70 P01
5.0 bar ±10%	DT A 50 x x 70 P01
7.0 bar ±10%	DT A 70 x x 70 P01
9.5 bar ±10%	DT A 95 x x 70 P01

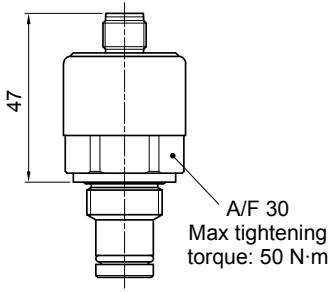

Hydraulic symbol

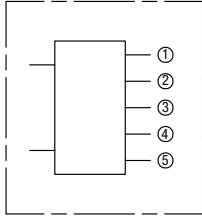

Electrical symbol

- ① ○ ——— ○ +24 Vdc
- ② ○ ——— ○ 4 ÷ 20 mA
- ③ ○ ——— ○ 75% - N.O. Digital output
- ④ ○ ——— ○ 100% - N.O. Digital output
- ⑤ ○ ——— ○ 0 Vdc

Materials

- Body: Brass
- Internal parts: Brass - Nylon
- Contacts: Silver
- Seal: HNBR - FPM

Technical data

- Max working pressure: 420 bar
- Proof pressure: 630 bar
- Burst pressure: 1260 bar
- Compatibility with fluids: Mineral oils, Synthetic fluids HFA, HFB, HFC according to ISO 2943
- Degree protection: IP67 according to EN 60529

Electrical data

- Electrical connection: IEC 61076-2-101 D (M12)
- Power supply: 24 Vdc
- Analogue output: From 4 to 20 mA
- Thermal lockout: 30 °C (all output signals stalled up to 30 °C)



DVA	
Visual Differential Indicator	
Settings	Ordering code
1.2 bar ±10%	DV A 12 x P01
2.0 bar ±10%	DV A 20 x P01
5.0 bar ±10%	DV A 50 x P01
7.0 bar ±10%	DV A 70 x P01
9.5 bar ±10%	DV A 95 x P01

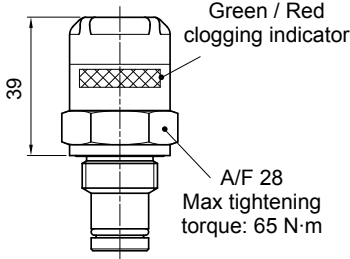

Hydraulic symbol

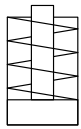

Materials

- Body: Brass
- Internal parts: Brass - Nylon
- Contacts: Silver
- Seal: HNBR - FPM

Technical data

- Reset: Automatic reset
- Max working pressure: 420 bar
- Proof pressure: 630 bar
- Burst pressure: 1260 bar
- Working temperature: From -25 °C to +110 °C
- Compatibility with fluids: Mineral oils, Synthetic fluids HFA, HFB, HFC according to ISO 2943
- Degree protection: IP65 according to EN 60529

DVM	
Visual Differential Indicator	
Settings	Ordering code
1.2 bar ±10%	DV M 12 x P01
2.0 bar ±10%	DV M 20 x P01
5.0 bar ±10%	DV M 50 x P01
7.0 bar ±10%	DV M 70 x P01
9.5 bar ±10%	DV M 95 x P01

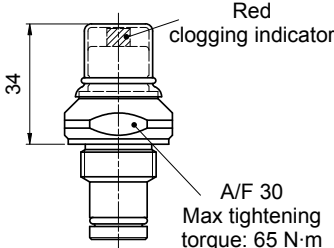

Hydraulic symbol

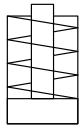

Materials

- Body: Brass
- Internal parts: Brass - Nylon
- Contacts: Silver
- Seal: HNBR - FPM

Technical data

- Reset: Manual reset
- Max working pressure: 420 bar
- Proof pressure: 630 bar
- Burst pressure: 1260 bar
- Working temperature: From -25 °C to +110 °C
- Compatibility with fluids: Mineral oils, Synthetic fluids HFA, HFB, HFC according to ISO 2943
- Degree protection: IP65 according to EN 60529

DIFFERENTIAL INDICATORS

Dimensions

DVS	
Visual Differential Indicator	
Settings	Ordering code
2.5 bar $\pm 10\%$	DV S 25 H P01
4.0 bar $\pm 10\%$	DV S 40 H P01

Hydraulic symbol

Materials

- Body: Brass
- Internal parts: Brass - Nylon
- Contacts: Silver
- Seal: HNBR

Technical data

- Reset: Automatic reset
- Max working pressure: 16 bar
- Proof pressure: 24 bar
- Burst pressure: 48 bar
- Working temperature: From -25 °C to +110 °C
- Compatibility with fluids: Mineral oils, Synthetic fluids
HFA, HFB, HFC according to ISO 2943
- Degree protection: IP67 according to EN 60529

T2	
Indicator plug	
Seal	Ordering code
HNBR	T2 H
FPM	T2 V

Materials

- Body: Phosphatized steel
- Seal: HNBR / FPM

DIFFERENTIAL INDICATORS

Series	Configuration example 1:	DE	H	50	F	A	70	P01
DE Electrical or Electronic differential indicator	Configuration example 2:	DE	M	50	H	F	50	P01
DL Electrical / Visual differential indicator	Configuration example 3:	DE	S	25	H	A	10	P01
DT Electronic differential indicator	Configuration example 4:	DL	E	70	V	A	71	P01
DV Visual differential indicator	Configuration example 5:	DT	A	50	H	F	70	P01
	Configuration example 6:	DV	M	95	V			P01
	Configuration example 7:	DV	S	40	H			P01

Type DE - DL - DT	DE	DL	DT	Type DV
A Standard type	•	•	•	A With automatic reset
E For high power supply		•		M With manual reset
H Hazardous area	•			S Compact version
M With wired electrical connection	•			
S Compact version	•			

Pressure setting	DEA	DEH	DEM	DES	DLA	DLE	DTA	DVA	DVM	DVS
12 1.2 bar	•		•		•	•	•	•	•	
20 2.0 bar	•		•		•	•	•	•	•	
25 2.5 bar				•						•
40 4.0 bar				•						•
50 5.0 bar	•	•	•		•	•	•	•	•	
70 7.0 bar	•	•	•		•	•	•	•	•	
95 9.5 bar	•		•		•	•	•	•	•	

Seals	DEA	DEH	DEM	DES	DLA	DLE	DTA	DVA	DVM	DVS
F MFQ		•								
H HNBR	•		•	•	•	•	•	•	•	•
V FPM	•	•	•		•	•	•	•	•	

Thermostat	DEA	DEH	DEM	DES	DLA	DLE	DTA
A Without		•	•	•	•	•	•
F With thermostat				•		•	•

Electrical connections	DEA	DEH	DEM	DES	DLA	DLE	DTA
10 Connection AMP Superseal series 1.5					•	•	
20 Connection AMP Timer Junior					•		
30 Connection Deutsch DT-04-2-P					•	•	
35 Connection Deutsch DT-04-3-P					•		
48 Connection M20			•				
49 Connection 1/2" NPT			•				
50 Connection EN 175301-803				•			•
51 Connection EN 175301-803, transparent base with lamps 24 Vdc							•
52 Connection EN 175301-803, transparent base with lamps 110 Vdc							•
70 Connection IEC 61076-2-101 D (M12)			•				•
71 Connection IEC 61076-2-101 D (M12), black base with lamps 24 Vdc						•	
80 Connection Stud #10-32 UNF					•		

Option
P01 MP Filtri standard
Pxx Customized

DESIGNATION & ORDERING CODE - DIFFERENTIAL INDICATOR PLUG

Series	Configuration example	T2	H
T2 Indicator plug			
Seals			
H HNBR			
V FPM			

STAINLESS STEEL DIFFERENTIAL INDICATORS

Dimensions

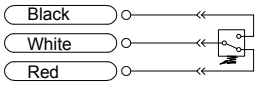
DEH*48		Hydraulic symbol	Materials
Hazardous Area Electronic Differential Indicator			
Settings	Ordering code		
5.0 bar ±10%	DE H 50 x A 48 P01	Electrical symbol 	Technical data - Max working pressure: 420 bar - Proof pressure: 630 bar - Burst pressure: 1260 bar - Working temperature: From -60 °C to +125 °C - Compatibility with fluids: Mineral oils, Synthetic fluids HFA, HFB, HFC according to ISO 2943 EX ia IIC T4/T6: Intrinsically safe - Protection class: T4 (135 °C) and T6 (85 °C) - Degree of protection: IP 66/67/68 according to EN 60529 - Connection type: Three-core cable - fitting M20x1.5 - Contact type: SPCO/SPDT (Hermetically sealed - Volt-free contacts)
7.0 bar ±10%	DE H 70 x A 48 P01		

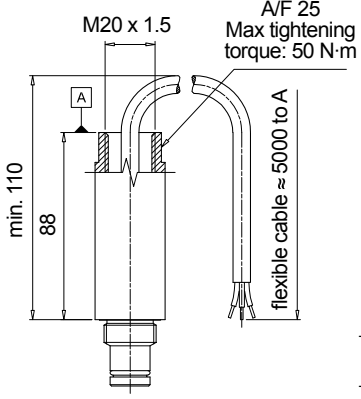

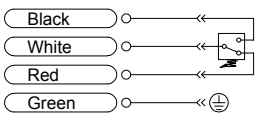

- Certification / Approvals:
ATEX, IECEx, EAC TR CU, INMETRO
- Certification included as standard

DEH*49		Hydraulic symbol	Materials
Hazardous Area Electronic Differential Indicator			
Settings	Ordering code		
5.0 bar ±10%	DE H 50 x A 49 P01	Electrical symbol 	Technical data - Max working pressure: 420 bar - Proof pressure: 630 bar - Burst pressure: 1260 bar - Working temperature: From -60 °C to +120 °C : ATEX, IECEx, EAC TR CU, INMETRO From -60 °C to +105 °C : UL/CSA - Compatibility with fluids: Mineral oils, Synthetic fluids HFA, HFB, HFC according to ISO 2943 - Protection class: Ex d IIC T4/T6: Flameproof - Temperature class: T4 (135 °C) and T6 (85 °C) - Degree of protection: IP 66/67/68 according to EN 60529 - Connection type: Four core-cable - fitting 1/2" NPT - Contact type: SPCO/SPDT (Hermetically sealed - Volt-free contacts)
7.0 bar ±10%	DE H 70 x A 49 P01		

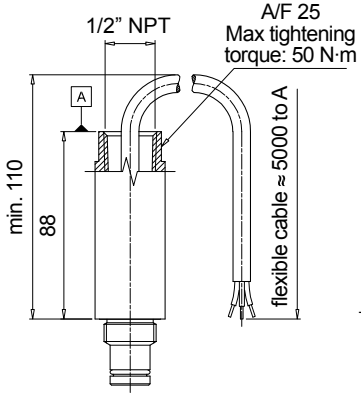

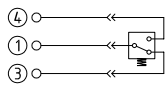

- Certification / Approvals:
ATEX, IECEx, EAC TR CU, INMETRO,
UL/CSA Class I Division 1 Groups A-D,
UL/CSA Class II Division 1 Groups E-G
- Certification included as standard

DEH*70		Hydraulic symbol	Materials
Hazardous Area Electronic Differential Indicator			
Settings	Ordering code		
5.0 bar ±10%	DE H 50 x A 70 P01	Electrical symbol 	Technical data - Max working pressure: 420 bar - Proof pressure: 630 bar - Burst pressure: 1260 bar - Working temperature: From -60 °C to +80 °C - Compatibility with fluids: Mineral oils, Synthetic fluids HFA, HFB, HFC according to ISO 2943 EX ia IIC T6: Intrinsically safe - Protection class: T6 (85 °C) - Degree of protection: IP 66/67 according to EN 60529 - Connection type: IEC 61076-2-101 D (M12) - Contact type: SPCO/SPDT (Hermetically sealed - Volt-free contacts)
7.0 bar ±10%	DE H 70 x A 70 P01		

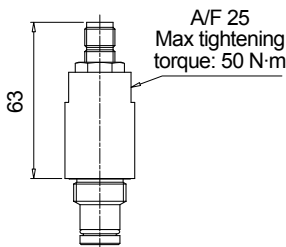



- Certification / Approvals:
ATEX, IECEx, EAC TR CU, INMETRO
- Certification included as standard

STAINLESS STEEL DIFFERENTIAL INDICATORS

Dimensions

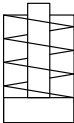
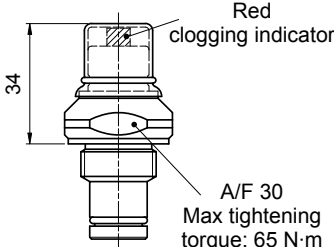
DVY		Hydraulic symbol	Materials
Visual Differential Indicator			
Settings	Ordering code		Materials - Body: AISI 316L - Internal parts: AISI 316L - Nylon - Contacts: Silver - Seal: HNBR - MFQ Technical data - Reset: Manual reset - Max working pressure: 420 bar - Proof pressure: 630 bar - Burst pressure: 1260 bar - Working temperature: From -25 °C to +110 °C - Compatibility with fluids: Mineral oils, Synthetic fluids HFA, HFB, HFC according to ISO 2943 - Degree protection: IP65 according to EN 60529
5.0 bar ±10%	DV Y 50 x P01		
7.0 bar ±10%	DV Y 70 x P01		
9.5 bar ±10%	DV Y 95 x P01		
			

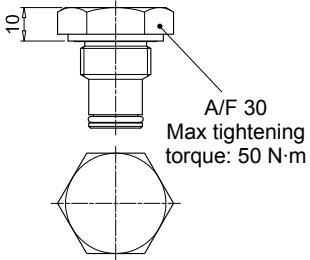
X2		Materials
Indicator plug		
Seal	Ordering code	Materials - Body: AISI 316L - Seal: HNBR / MFQ
HNBR	X2 H	
MFQ	X2 F	
		

STAINLESS STEEL DIFFERENTIAL INDICATORS

Designation & Ordering code

STAINLESS STEEL DIFFERENTIAL INDICATORS

Series					Configuration example 1:						
DE	Electrical differential indicator				DE	H	50	F	A	70	P01
DL	Electrical / Visual differential indicator				DE	X	50	H	A	50	P01
DV	Visual differential indicator				DL	X	95	V	A	71	P01
					DV	Y	70	V			P01

Type	DE	DL	DV
H Hazardous area	•		
X Standard type	•	•	•
Y Optional type			•

Pressure setting	DEH	DEX	DLX	DVX-DVY
50 5.0 bar	•	•	•	•
70 7.0 bar	•	•	•	•
95 9.5 bar		•	•	•

Seals	DEH	DEX	DLX	DVX-DVY
F MFQ	•			
H HNBR		•	•	•
V FPM	•	•	•	•

Thermostat
A Without

Electrical connections	DEH	DEX	DLX
48 Connection M20	•		
49 Connection 1/2" NPT	•		
50 Connection EN 175301-803		•	
51 Connection EN 175301-803, transparent base with lamps 24 Vdc			•
52 Connection EN 175301-803, transparent base with lamps 110 Vdc			•
70 Connection IEC 61076-2-101 D (M12)	•		

Option
P01 MP Filtri standard
Pxx Customized

DESIGNATION & ORDERING CODE - DIFFERENTIAL INDICATOR PLUG

Series		Configuration example	
X2	Indicator plug	X2	H

Seals
H HNBR
F MFQ

Filter family	Filter series	Electrical indicator	Electrical / Visual indicator	Electronic indicator	Visual indicator
SUCTION FILTERS	ELIXIR® SFEX060-080-110-160	VEB21AA50P01	VLB21AA51P01 VLB21AA52P01 VLB21AA53P01 VLB21AA71P01		VVB16P01 VVS16P01
	SF2 250 - 350 SF2 500 - 501 - 503 - 504 - 505 SF2 510 - 535 - 540	VEA21AA50P01	VLA21AA51P01 VLA21AA52P01 VLA21AA53P01 VLA21AA71P01		VVA16P01 VVR16P01
RETURN FILTERS	With bypass valve ELIXIR® RFEX060-080-110-160	BEA15HA50P01 BEM15HA41P01	BLA15HA51P01 BLA15HA52P01 BLA15HA53P01 BLA15HA71P01		BVA14P01 BVR14P01 BVP15HP01 BVQ15HP01
	Without bypass valve ELIXIR® RFEX060-080-110-160	BEA20HA50P01 BEM20HA41P01	BLA20HA51P01 BLA20HA52P01 BLA20HA53P01 BLA20HA71P01		BVA25P01 BVR25P01 BVP20HP01 BVQ20HP01
	With bypass valve MPFX-MPTX-MPF-MPT - bypass 1.75 bar MPH - bypass 1.75 bar RF2250 - RF2350 - bypass 1.75 bar	BEA15HA50P01 BEM15HA41P01	BLA15HA51P01 BLA15HA52P01 BLA15HA53P01 BLA15HA71P01		BVA14P01 BVR14P01 BVP15HP01 BVQ15HP01
	With bypass valve MPFX-MPTX-MPF-MPT - bypass 3 bar MPH - bypass 2.5 bar FRI 255 RF2250 - RF2350 - bypass 3 bar	BEA20HA50P01 BEM20HA41P01	BLA20HA51P01 BLA20HA52P01 BLA20HA53P01 BLA20HA71P01		BVA25P01 BVR25P01 BVP20HP01 BVQ20HP01
MPLX FRI 025 - 040 - 100 - 250 - 630 - 850	DEA20xA50P01 DEM20xA10P01 DEM20xA20P01 DEM20xA30P01 DEM20xA35P01	DLA20xA51P01 DLA20xA52P01 DLA20xA71P01 DLE20xA50P01 DLE20xF50P01	DTA20xF70P01	DVA20xP01 DVM20xP01	
RETURN / SUCTION FILTERS	Suction line MRSX 116 - 165 - 166	VEB21AA50P01	VLB21AA51P01 VLB21AA52P01 VLB21AA53P01 VLB21AA71P01		VVB16P01 VVS16P01
	Return line MRSX 116 - 165 - 166 LMP 124 MULTIPORT	BEA25HA50P01 BEM25HA41P01 BET25HF10P01 BET25HF30P01 BET25HF50P01	BLA25HA51P01 BLA25HA52P01 BLA25HA53P01 BLA25HA71P01		BVA25P01 BVR25P01 BVP20HP01 BVQ20HP01
SPIN-ON FILTERS	Suction line MPS 050 - 070 - 100 - 150 MPS 200 - 250 - 300 - 350	VEB21AA50P01	VLB21AA51P01 VLB21AA52P01 VLB21AA53P01 VLB21AA71P01		VVB16P01 VVS16P01
	Return line MPS 050 - 070 - 100 - 150 MPS 200 - 250 - 300 - 350	BEA15HA50P01 BEM15HA41P01	BLA15HA51P01 BLA15HA52P01 BLA15HA53P01 BLA15HA71P01		BVA14P01 BVR14P01 BVP20HP01 BVQ20HP01
	In-line MPS 051 - 071 - 101 - 151 MPS 301 - 351 MSH 050 - 070 - 100 - 150	DEA12xA50P01 DEM12xAxxP01	DLA12xA51P01 DLA12xA52P01 DLA12xA71P01 DLE12xA50P01 DLE12xF50P01 DLE20xF50P01 DLE20xF50P01	DTA12xA70P01 DTA12xF70P01 DTA20xA70P01 DTA20xF70P01	DVA12xP01 DVM12xP01

Filter family	Filter series	Electrical indicator	Electrical / Visual indicator	Electronic indicator	Visual indicator	Hazardous area electronic indicator 				
LOW & MEDIUM PRESSURE FILTERS	With bypass valve	ELIXIR® LFEX060-080-110-160	DES25HA10P01 DES25HA30P01 DES25HA80P01			DVS25HP01				
	Without bypass valve	ELIXIR® LFEX060-080-110-160	DES40HA10P01 DES40HA30P01 DES40HA80P01			DVS40HP01				
		LMP 110 - 112 - 116 - 118 - 119 MULTIPORT LMP 120 - 122 - 123 MULTIPORT LMP 210 - 211 - LDP					DVS25HP01 DVS40HP01			
	With bypass valve	LMP 400 - 401 & 430 - 431 LMP 900 - 901 LMP 902 - 903 LMP 950 - 951 LMP 952 - 953 - 954 LMD 211 - 400 - 401 - 431 - 951 - LDD	DEA20xA50P01 DEM20xAxxP01	DLA20xA51P01 DLA20xA52P01 DLA20xA71P01 DLE20xA50P01 DLE20xF50P01	DTA20xF70P01		DVA20xP01 DVM20xP01			
	Without bypass valve	LMP 110 - 112 - 116 - 118 - 119 MULTIPORT LMP 120 - 122 - 123 MULTIPORT LMP 210 - 211 - LDP LMP 400 - 401 & 430 - 431 LMP 900 - 901 LMP 902 - 903 LMP 950 - 951 LMP 952 - 953 - 954 LMD 211 - 400 - 401 - 431 - 951 - LDD	DEA50xA50P01 DEM50xAxxP01	DLA50xA51P01 DLA50xA52P01 DLA50xA71P01 DLE50xA50P01 DLE50xF50P01	DTA50xF70P01		DVA50xP01 DVM50xP01			
	HIGH PRESSURE FILTERS	With bypass valve	FMP 039 - 065 - 135 - 320 FHP 010 - 011 - 065 - 135 - 350 - 500 FMM 050 - 150 FHA 051 FHM 006 - 007 - 010 - 050 - 065 - 135 - 320 - 500 FHB 050 - 065 - 135 - 320 FHF 325 FHD 021 - 051 - 326 - 333	DEA50xA50P01 DEM50xAxxP01	DLA50xA51P01 DLA50xA52P01 DLA50xA71P01 DLE50xA50P01 DLE50xF50P01	DTA50xF70P01		DEH50xA48P01 DEH50xA49P01 DEH50xA70P01 DEH70xA48P01 DEH70xA49P01 DEH70xA70P01		
		Without bypass valve	FMP 039 - 065 - 135 - 320 FHP 010 - 011 - 065 - 135 - 350 - 500 FMM 050 - 150 FHA 051 FHM 006 - 007 - 010 - 050 - 065 - 135 - 320 - 500 FHB 050 - 065 - 135 - 320 FHF 325 FHD 021 - 051 - 326 - 333	DEA70xA50P01 DEM70xAxxP01 DEA95xA50P01 DEM95xAxxP01	DLA70xA51P01 DLA70xA52P01 DLA70xA71P01 DLE70xA50P01 DLE70xF50P01 DLA95xA51P01 DLA95xA52P01 DLE95xA50P01 DLE95xF50P01	DTA70xF70P01 DTA95xF70P01		DVA70xP01 DVM70xP01 DVA95xP01 DVM95xP01	DEH50xA48P01 DEH50xA49P01 DEH50xA70P01 DEH70xA48P01 DEH70xA49P01 DEH70xA70P01	
		With bypass valve	FZH 010 - 011 - 039 FZP 039 - 136 FZX 011 FZB 039 FZM 039 FZD 051	DEX50xA50P01	DLX50xA51P01 DLX50xA52P01			DVX50xP01 DVY50xP01	DEH50xA48P01 DEH50xA49P01 DEH50xA70P01 DEH70xA48P01 DEH70xA49P01 DEH70xA70P01	
		Without bypass valve	FZH 010 - 011 - 039 FZP 039 - 136 FZB 039 FZM 039 FZD 010 - 021 - 051	DEX70xA50P01 DEX95xA50P01	DLX70xA51P01 DLX70xA52P01 DLX95xA51P01			DVX70xP01 DVY70xP01 DVX95xP01 DVY95xP01	DEH50xA48P01 DEH50xA49P01 DEH50xA70P01 DEH70xA48P01 DEH70xA49P01 DEH70xA70P01	

All data, details and words contained in this publication are provided for information purposes only.
MP Filtri reserves the right to make modifications to the models and versions of the described products at any time
for both technical and / or commercial reasons.
The colors and the pictures of the products are purely indicative.
Any reproduction, partial or total, of this document is strictly forbidden.
All rights are strictly reserved.



WORLDWIDE NETWORK

HEADQUARTERS

MP Filtri S.p.A.
Pessano con Bornago
Milano
Italy
sales@mpfiltri.com

BRANCH OFFICES

ITALFILTRI LLC
Moscow
Russia
mpfiltrirussia@yahoo.com

MP Filtri Canada Inc.
Concord, Ontario
Canada
sales@mpfiltricanada.com

MP Filtri France SAS
Lyon
AURA
France
sales@mpfiltrifrance.com

MP Filtri Germany GmbH
St. Ingbert
Germany
sales@mpfiltri.de

MP Filtri India Pvt. Ltd.
Bangalore
India
sales@mpfiltri.co.in

MP Filtri (Shanghai) Co., Ltd.
Shanghai
P.R. China
sales@mpfiltrishanghai.com

MP Filtri SEA PTE Ltd.
Singapore
sales-sea@mpfiltri.com

MP Filtri U.K. Ltd.
Bourton on the Water
Gloucestershire
United Kingdom
sales@mpfiltri.co.uk

MP Filtri U.S.A. Inc.
Quakertown, PA
U.S.A.
sales@mpfiltriusa.com

PASSION TO PERFORM



mpfiltri.com