

TL series

Subminiature washable toggle switches



DISTINCTIVE FEATURES

- Process sealed
- Single piece case
- Front and rear sealing
- Wide variety of contact materials
- Same PCB layout as TP, TR and TG subminiature switches



ENVIRONMENTAL SPECIFICATIONS

- Operating temperature : -30 °C to +85 °C (-22 °F to +185 °F)
- Moisture : 21 days 95 % (NFC 20-603 - IEC 68-2-3)



ELECTRICAL SPECIFICATIONS

- Max. current/voltage rating with resistive load :
 - gold plated contacts : 0.4 VA 20 V max. AC or DC
 - silver plated contacts : 0.5 A 48 V max. AC or DC
- Minimum load : 10 mA 50 mV - 10 μ A 5 VDC
- Contact resistance : 20 m Ω max.
- Insulation resistance : 1,000 M Ω min. at 500 VDC
- Dielectric strength :
 - 1,000 Vrms 50 Hz min. between terminals and frame
 - 500 Vrms 50 Hz min. between terminals
- Electrical life at full load :

Contacts	Number of cycles	
	2 positions	3 positions
Gold plated	60,000	30,000
Silver plated	20,000	10,000



GENERAL SPECIFICATIONS

- Strength of terminals : pull-out force - 10 N max.
- Cleaning : solvents or water + detergent
- Wave soldering : 260 °C (500 °F) - 5 sec.

The company reserves the right to change specifications without notice.



TL series

Subminiature washable toggle switches



MATERIALS

- Case : PBT
- Actuator : brass, nickel plated
- Contacts and terminals :
 - 0 : brass, gold plated
 - 1 : brass, silver plated
 - 3 : brass, gold plated (1,27 micron gold)
 - 8 : contact brass, gold plated + tin plated terminals
 - 9 : contact brass, gold plated (1,27 micron gold) + tin plated terminals
- Terminal seal : epoxy

APEM products may be recycled at end-of-life for the re-claiming of valuable metal components.



TERMINALS

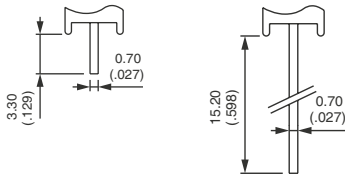

ELECTRICAL FUNCTIONS

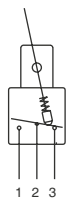

PCB MOUNTING

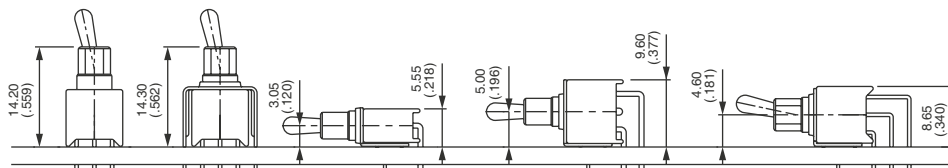



BUILD YOUR PART NUMBER

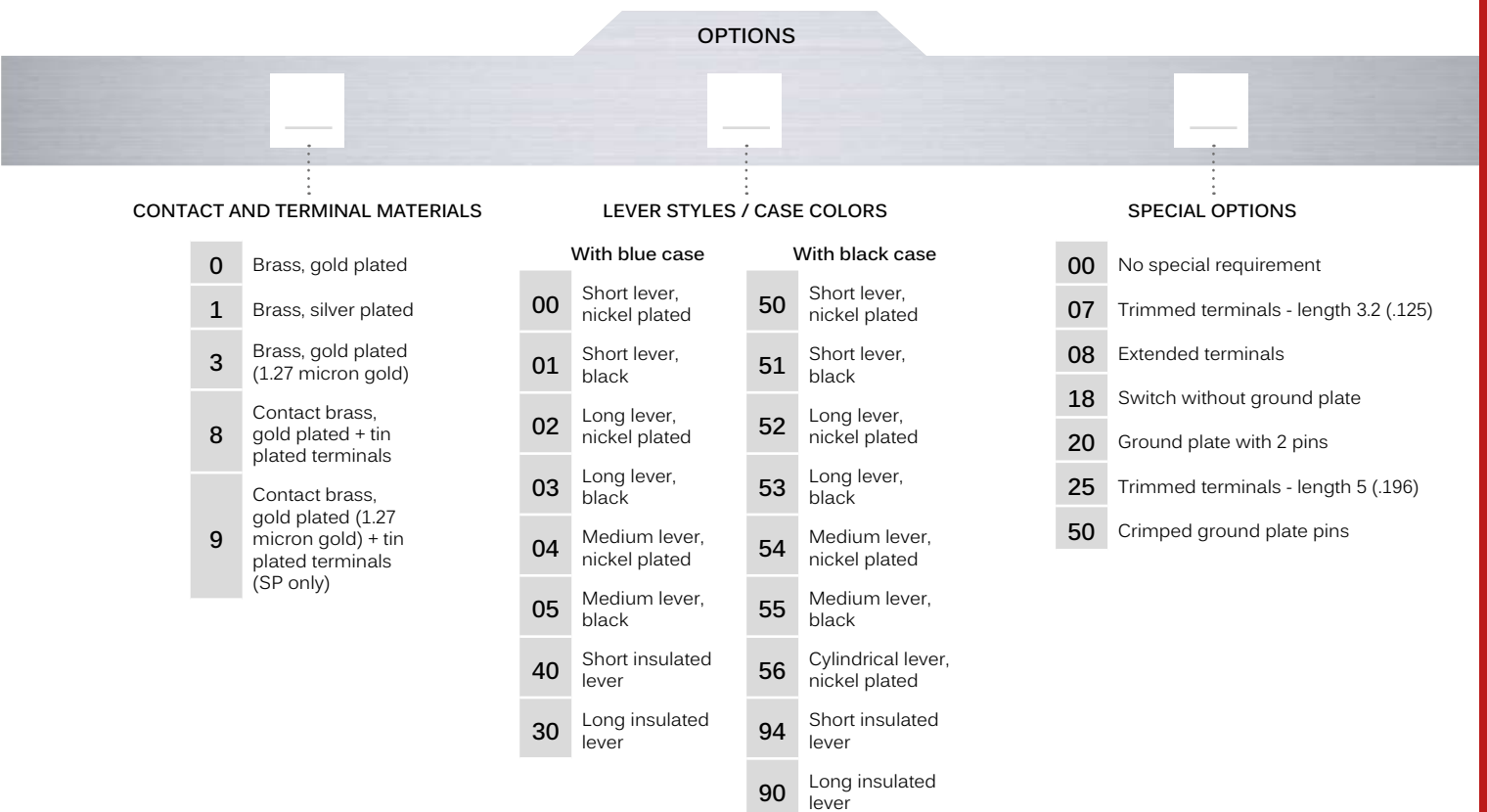
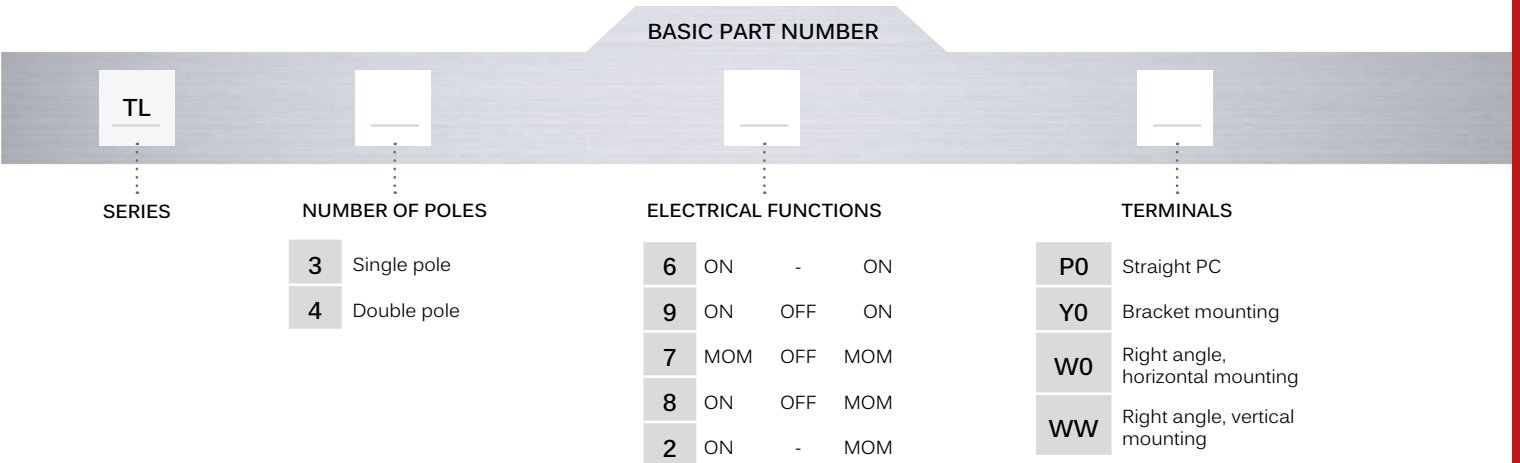

ABOUT THIS SERIES

On the following pages, you will find successively basic part numbers of switches and options in the same order as in above chart.

Notice : please note that not all combinations of above numbers are available. Refer to the following pages for further information.

TL series

Subminiature washable toggle switches

STRAIGHT PC TERMINALS : TL..P0



Single pole	Double pole	III	II	I
TL36P0	TL46P0	ON	-	ON
TL39P0	TL49P0	ON	OFF	ON
TL37P0	TL47P0	MOM	OFF	MOM
TL38P0	TL48P0	ON	OFF	MOM
TL32P0	TL42P0	ON	-	MOM

STRAIGHT PC TERMINALS BRACKET MOUNTING : TL..Y0



Single pole	Double pole	III	II	I
TL36Y0	TL46Y0	ON	-	ON
TL39Y0	TL49Y0	ON	OFF	ON
TL37Y0	TL47Y0	MOM	OFF	MOM
TL38Y0	TL48Y0	ON	OFF	MOM
TL32Y0	TL42Y0	ON	-	MOM

RIGHT ANGLE TERMINALS HORIZONTAL MOUNTING : TL..W0



Single pole	Double pole	III	II	I
TL36W0	TL46W0	ON	-	ON
TL39W0	TL49W0	ON	OFF	ON
TL37W0	TL47W0	MOM	OFF	MOM
TL38W0	TL48W0	ON	OFF	MOM
TL32W0	TL42W0	ON	-	MOM

RIGHT ANGLE TERMINALS VERTICAL MOUNTING : TL..WW



Single pole	Double pole	III	II	I
TL36WW	TL46WW	ON	-	ON
TL39WW	TL49WW	ON	OFF	ON
TL37WW	TL47WW	MOM	OFF	MOM
TL38WW*	TL48WW*	ON	OFF	MOM
TL32WW*	TL42WW*	ON	-	MOM

*Functions 2 and 8 : reversed connection available. On request.

Shown with standard lever

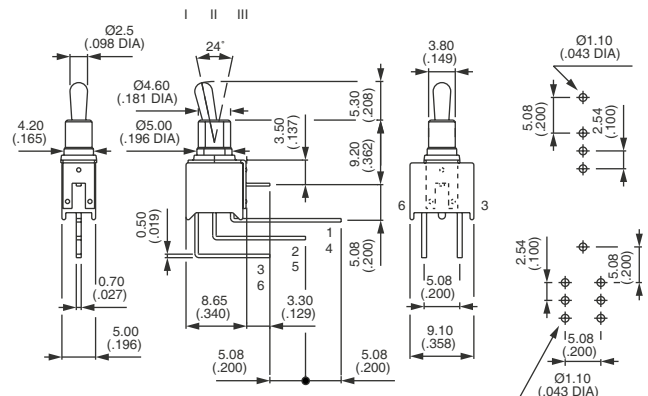
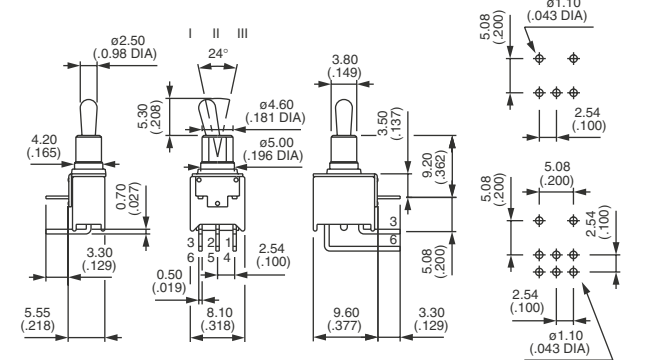
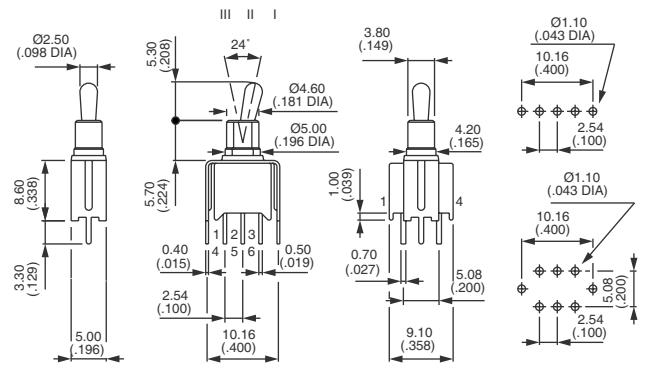
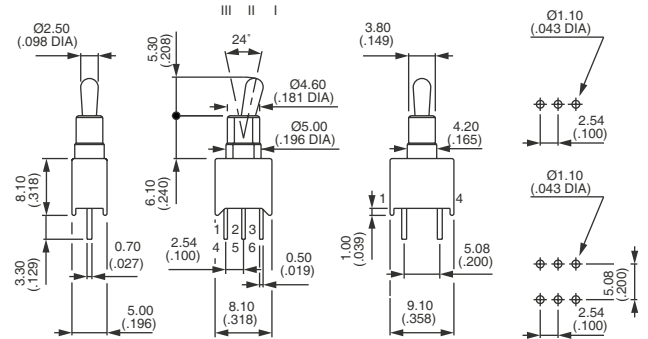

CONTACT AND TERMINAL MATERIALS



- 0 Brass, gold plated
- 1 Brass, silver plated
- 3 Brass, gold plated (1.27 micron gold)
- 8 Contact brass, gold plated + tin plated terminals
- 9 Contact brass, gold plated (1.27 micron gold) + tin plated terminals (single pole only)

LEVER AND CASE STYLES

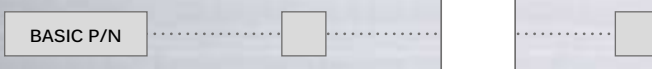

SHORT - STANDARD

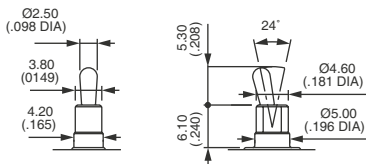

CASE		Blue	Black
LEVER			
Nickel plated		00	50
Black		01	51

LONG

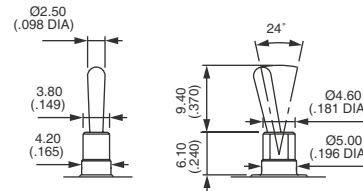

CASE		Blue	Black
LEVER			
Nickel plated		02	52
Black		03	53

MEDIUM

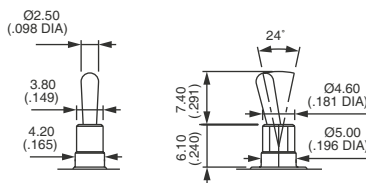

CASE		Blue	Black
LEVER			
Nickel plated		04	54
Black		05	55

CYLINDRICAL

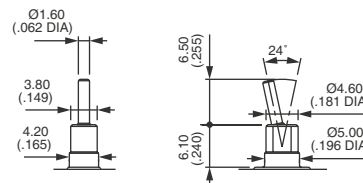

CASE		Blue	Black
LEVER			
Nickel plated		-	56

INSULATED LEVERS

Protected against electrostatic discharges (ESD) up to 10 KV.

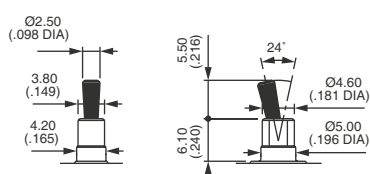

CASE		Blue	Black
LEVER			
Black		40	94

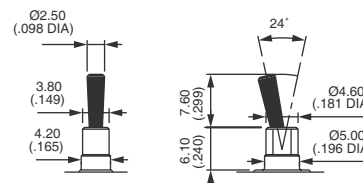

CASE		Blue	Black
LEVER			
Black		30	90

TL series

Subminiature washable toggle switches

SPECIAL OPTIONS

- BASIC P/N
- 00 No special requirement
 - 07 **Trimmed terminals** - length 3,2 mm (.125) for TL..WW models only
 - 08 **Extended terminals** for TL..W0 models only
 - 18 **Switch without ground plate** for TL..WW models only
 - 20 **Ground plate with 2 pins** for TL..WW models only
 - 25 **Trimmed terminals** - length 5 mm (.196) for all models, except TL..WW
 - 50 **Crimped ground plate pins.**
Retains switch on PCB during handling and wave soldering.
For models TL..W0, TL..WW and TL..Y0 single and double pole.

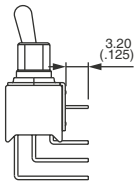

07

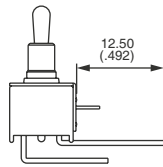

08

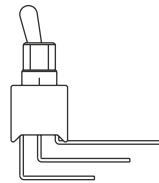

18

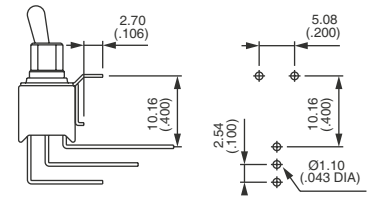

20

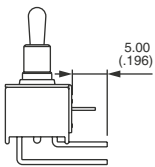

25

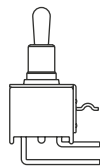

50